



4K UST LASER PROJECTOR Quick Start Guide



1

Press and hold the **Return** and **Menu** buttons simultaneously to pair the remote control. Make sure

- a) the projector is turned on by pressing the Power Button,
- b) the batteries are installed in the remote control,
- b) the remote control is close to the projector.

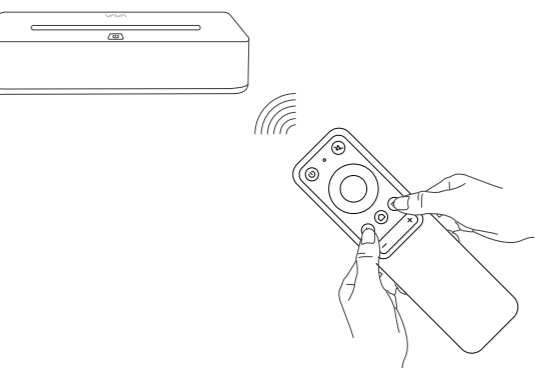
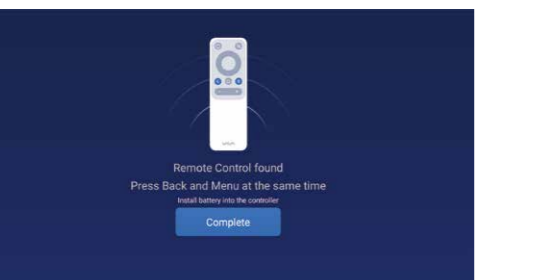

2

The VAVA 4K Projector and the projection area require a flat surface to produce an even image. In most cases, a distorted image is caused by an uneven surface such as a curved or textured wall.

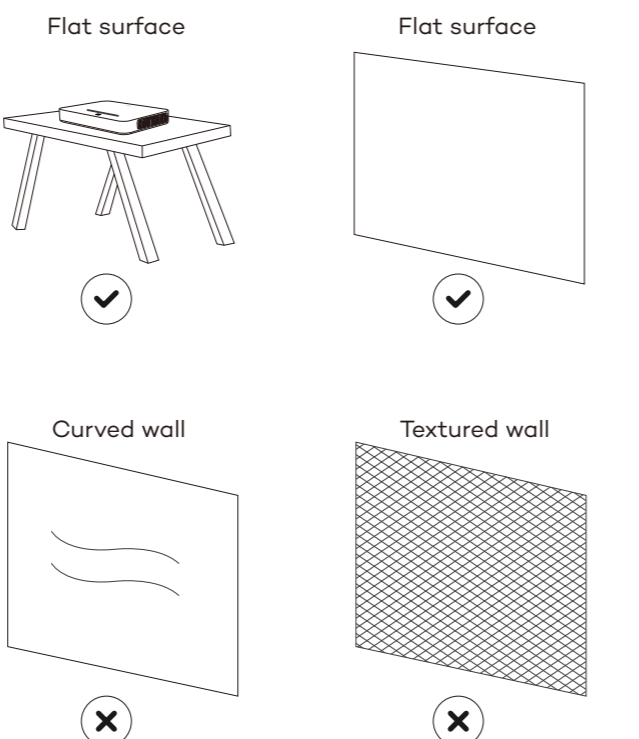

Leave enough cooling space (at least 30cm of each side) for the projector.

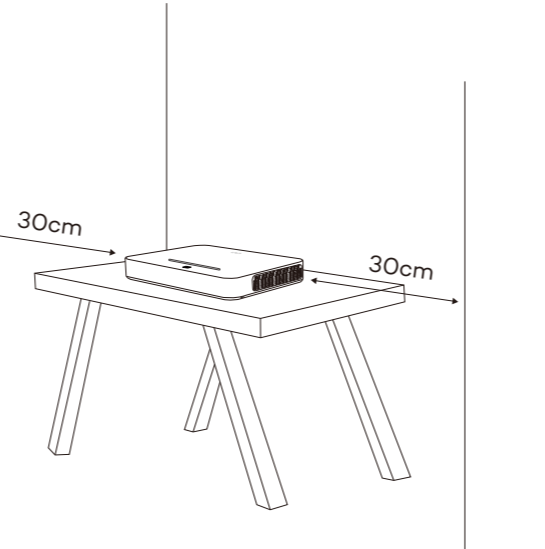

For optimal projection, it is recommended to use under a dark environment. An ALR (Ambient Light Rejecting) Screen compatible with Ultra Short Throw Projector is better.

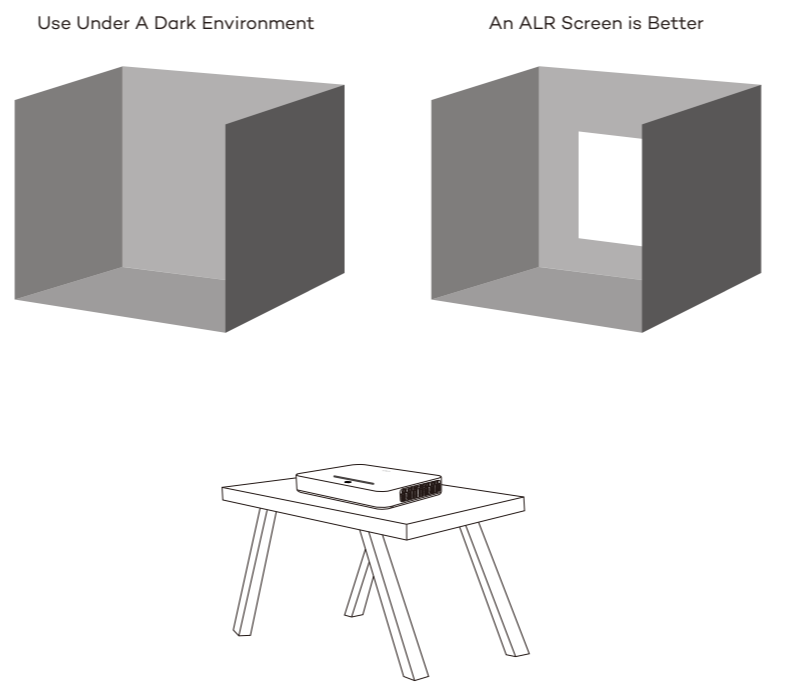

3

You can fine-tune your picture via **Keystone/Focus** options in Settings.

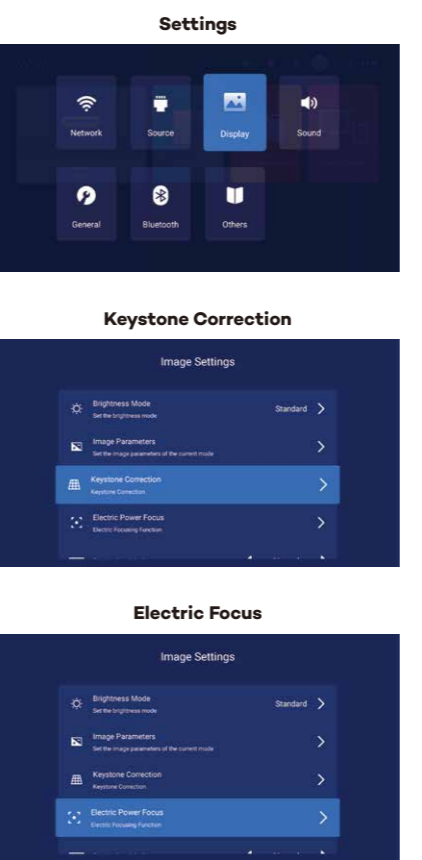

Keystone Correction

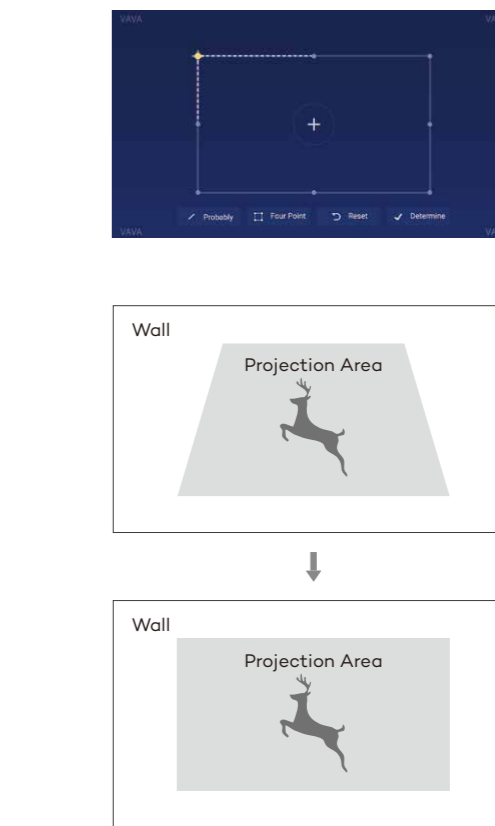

www.vava.com

ASIA PACIFIC
E-mail: support.jp@vava.com(JP)
JP Importer: 株式会社SUNVALLEY JAPAN
Address: 〒104-0032 東京都中央区八丁堀3丁目18-6 PMO京橋東9F

EUROPE
E-mail:
support.uk@vava.com(UK)
support.de@vava.com(DE)
support.fr@vava.com(FR)
support.es@vava.com(ES)
support.it@vava.com(IT)

NORTH AMERICA
E-mail: support@vava.com
Tel: 1-877-969-8282 (Monday-Friday: 9:00 – 17:00 PST)

MANUFACTURER
Manufacturer: Shenzhen NearbyExpress Technology Development Co.,Ltd.
Address: Floor 7, Building E, Galaxy World Phase II, Shenzhen, China

For any questions or concerns
Please email us at **support@vava.com** or call us at **1-877-969-8282** (Monday-Friday: 9:00 – 17:00 PST)

Made in China

Electric Focus

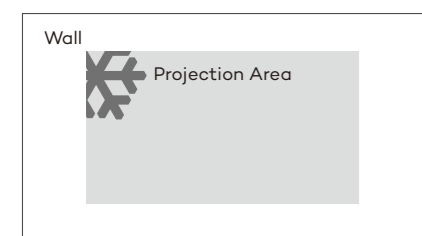
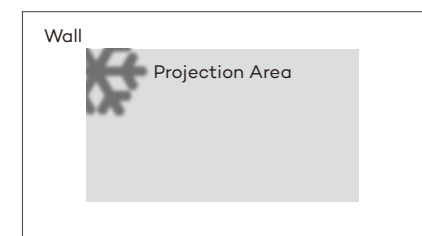
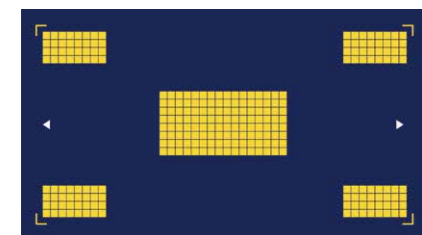

4

Press the **Home button** twice to close the apps.

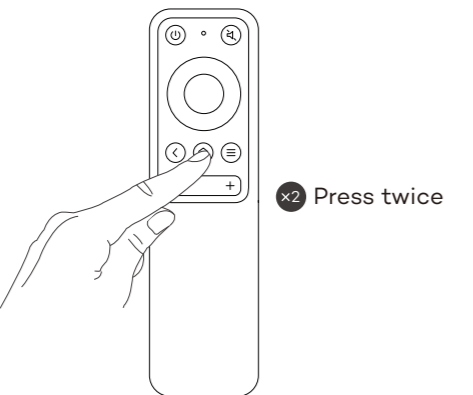

5

You can also operate the VAVA 4K Projector by using a mouse and keyboard via the USB port.

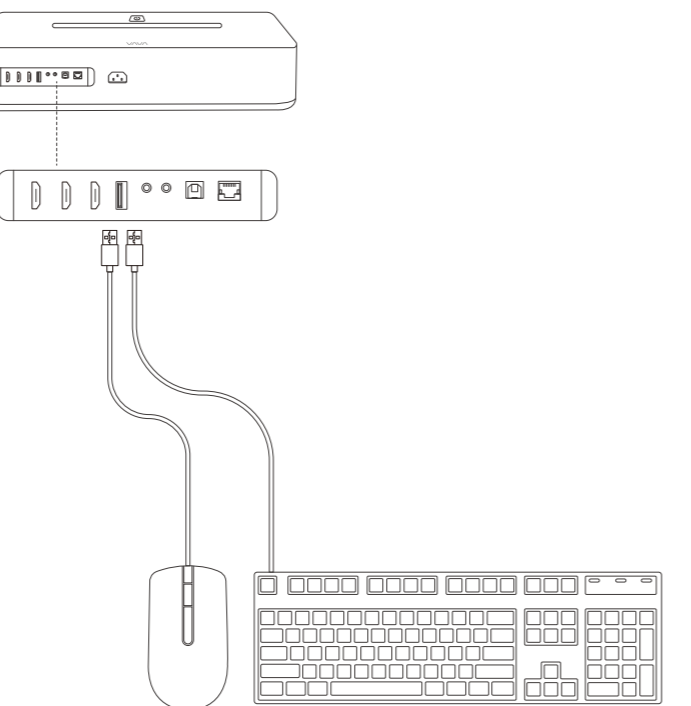

6

The VAVA Projector App allows your mobile device to operate as a remote control and mirror content. Download the app and make sure the projector and the phone are connected to the same network.

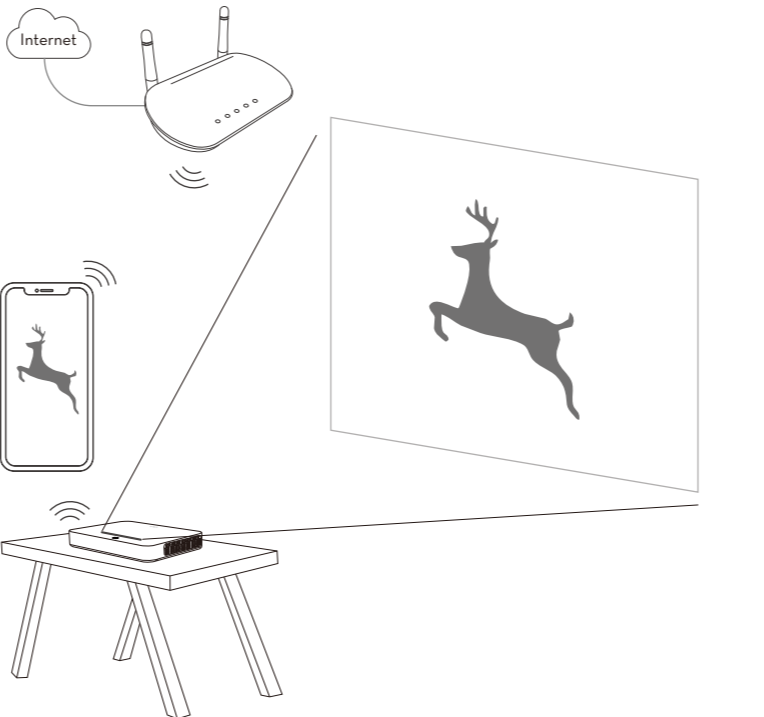

7

In the HDMI interface, press the **Menu** button to enter the sub-menu interface. Turn on HDMI 2.0 to support 4K 60 Hz output and HDR10.

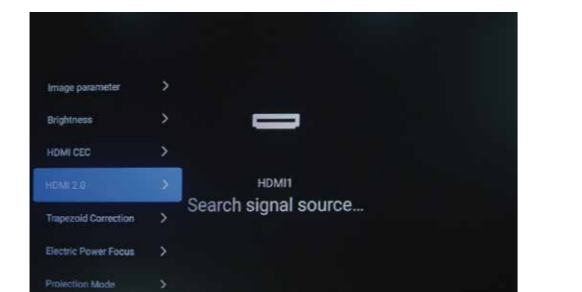
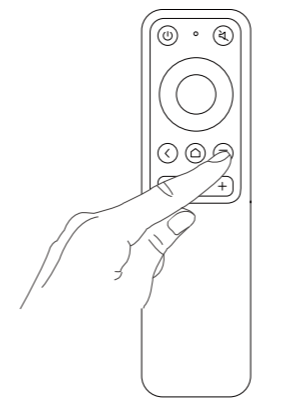

8

Most technical problems can be solved by rebooting the projector. If the problem still persists, try to perform a factory reset in Settings.

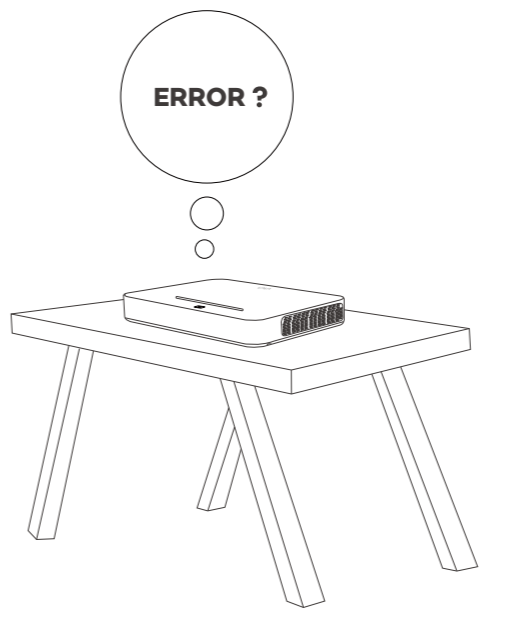

💡 Long press to turn off, then press once to turn on.

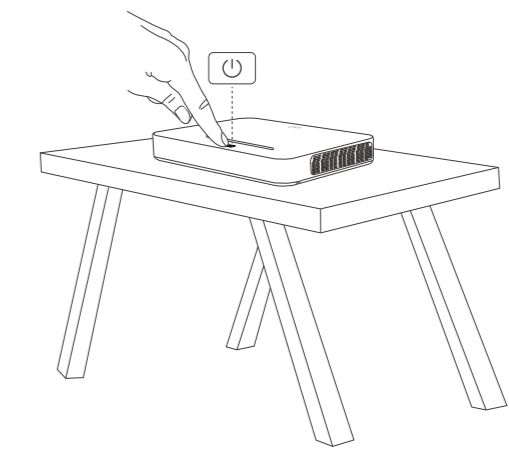

💡 Factory Reset in Settings

