

# Panasonic



Operating Instructions  
使用說明書

Portable Oral Irrigator  
便攜式沖牙機

Model No. EW-DJ10  
型號 EW-DJ10

---

English	2
中文	13

Before operating this product, please read the instructions carefully, and save this manual for future use.

使用本產品之前，請仔細閱讀使用說明書，並妥善保存本說明書以便日後使用。

## Safety Instructions

English

All information in this section is provided to instruct you in the correct and safe operation of this appliance so that you can avoid injuries to yourself and others as well as damage to property.

■ **The harm or damage that is caused by improper use is described in categories.**

### **Warning**

This indicates “content that may cause death or severe injury”.

### **Caution**

This indicates “content that may cause injury or damage to property”.

■ **Content to be observed is described with the following icons. (The following are examples of icons)**

 A circle and slash symbolizes prohibited actions and behaviors.

 A solid circle denotes mandatory actions and instructions to be followed for safe operation.

### **Warning**

#### **Mandatory!**

• **Keep out of the reach of toddlers and infants.**

Failure to do so could result in accidents or trouble, such as an accidental ingestion of the accessories or the parts that can be taken apart.

### **Caution**

#### **Prohibited**

• **Toddlers, infants, people who are unable to operate and people with weak oral senses should not use this appliance.**

Failure to do so could result in injury.

• **Do not use for any purpose other than oral cleaning.**

Doing so could result in injury when the stream of water is pointed toward the eyes, nose, ears, or throat. Consult the dentist if you are receiving oral treatments or have severe periodontal disease.

• **Do not fill the tank with water warmer than 40 °C.**

Doing so could result in burns.

**!** **Mandatory!**

- **Keep the appliance sanitized and use fresh tap water or warm water when cleaning the mouth.**
- **Make sure to throw out the water inside the tank, and run the appliance for 2 to 3 seconds to drain the water after usage.**

Failure to do so could result in damage to your health if used without keeping it sanitized due to propagation of mold and bacteria. It may also result in odor and malfunction.

- **Observe the caution written on the batteries.**
- **Insert the batteries correctly checking the + and - terminals.**
- **Remove used batteries immediately.**
- **Remove the batteries when the appliance is not to be used for a long period.**
- **Use the batteries by the recommended use-by date.**

Failure to do so may cause overheating or explosion of the batteries, injury or contamination of surroundings due to leakage.

**⚠ Do not dismantle!**

- **Never alter the appliance. Also, do not disassemble or repair it.**

Doing so could result in fire, electric shock, or injury.

### Caution

- This appliance is not intended for use by persons (including children) with reduced physical, sensory or mental capabilities, or lack of experience and knowledge, unless they have been given supervision or instruction concerning use of the appliance by a person responsible for their safety.  
Children should be supervised to ensure that they do not play with the appliance.

## Parts identification

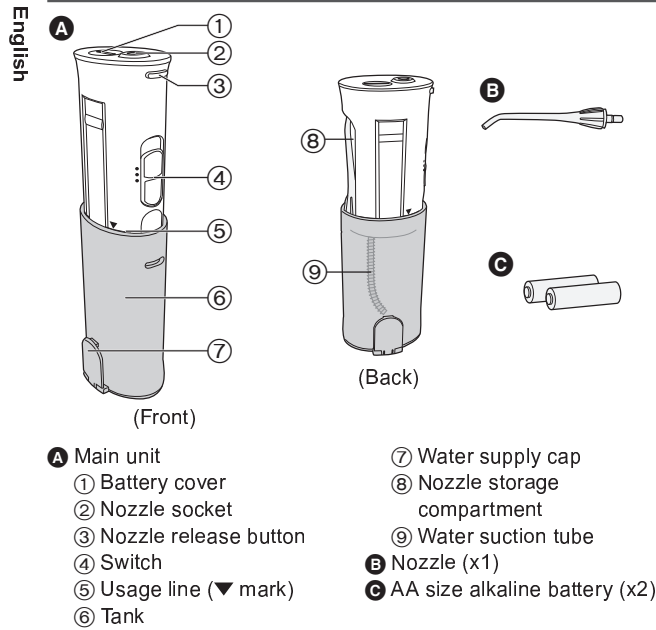

### ► Note

There may be some liquid remaining inside the main appliance before use (tank, water suction tube, etc), this is the remaining distilled water that was used for the performance (water flow) test, so there are no health concerns.

### ► Before using the appliance

Initially bleeding may occur even with healthy gums. This is caused because the gums are not used to such stimulation. The bleeding will normally stop within 1 or 2 weeks of use. There may be a problem with the gums (periodontal disease, etc.) if the bleeding continues for over 2 weeks. In such cases, stop using the appliance and consult the dentist.

## Insert the alkaline batteries

- Wipe the appliance so no water goes inside.

**1** Open the battery cover by turning it to OPEN.

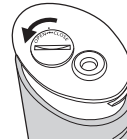

English

**2** Insert two AA size alkaline batteries.

- Please use Panasonic alkaline batteries (AA size).  
(It can be used for approximately 30 times with full tank usage, or approximately 20 minutes of continuous usage.)
- Do not use rechargeable batteries. Doing so may result in the leakage of the battery leading to malfunction.

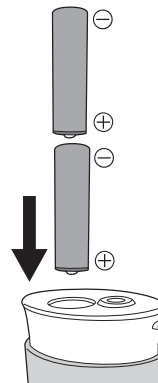

**3** Close the battery cover by turning it to CLOSE.

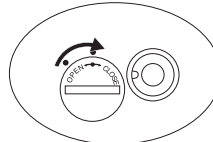

## Using the appliance

English

- Use with tap water or lukewarm water.
- Do not turn the switch to ON before placing the nozzle in your mouth.

### 1 Open the water supply cap.

### 2 Pull out the white part of main unit up to the usage line (▼ mark).

- It may be hard to pull out the main unit with the water supply cap closed.
- Water pressure will not rise unless the main unit is pulled out to the usage line.
- Be careful since the nozzle might pop out from the storage compartment at this time.

### 3 Insert the nozzle into the nozzle socket holding onto the white part of the main unit.

- Insert it securely until it clicks.

### 4 Pour in water.

- Always use fresh tap water.
- If the water feels cold, use lukewarm water of up to 40 °C.
- Do not pour in salt, toothpaste, or chemicals.
- To continuously use, make sure the switch is set to OFF.

### 5 Close the water supply cap.

- Securely close after pouring in water.

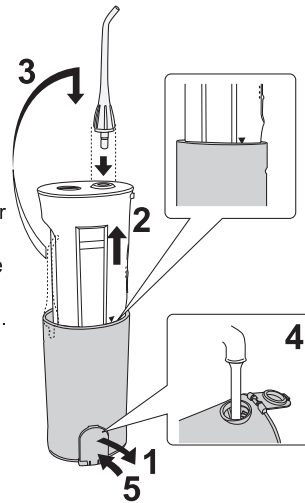

- 6 Place the nozzle in your mouth.**
- The water suction tube inside the tank may come out from the water and the flow of the water may stop when the appliance is tilted too much.

- 7 Turn the switch to ON.**
- It can be used for approximately 40 seconds with a full tank.
- Mode (strength) can be selected.

**2 (Normal)**

- For normal cleaning

**1 (Soft)**

- When you are worried about your gums
- When you feel 2 (Normal) is too strong

- Do not press the tip of the nozzle hard against the teeth or gums.
- Be extra cautious with those who cannot operate the appliance by themselves, such as infants or toddlers, or people with high oral sensitivity.
- Do not drop or handle it roughly.
- Do not operate when the tank is empty except to drain the water from the appliance.  
Doing so could result in malfunction.

► **Tips**

- Hold the appliance vertically with the nozzle upward.
- Move your face above the sink.
- Close your mouth slightly so the water will not splatter.
- Place the nozzle in your mouth.

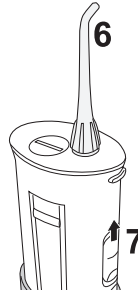

English

## Cleaning your mouth well

English

- Aim the stream as perpendicular as possible between the teeth or the edge between the teeth and gums.
- Move slowly along the teeth.
- Take extra care between the teeth and around braces.

### Front side of the teeth...

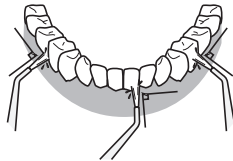

- Apply the stream perpendicular to the teeth.
- Take extra care between the teeth and the edge between the teeth and gums.

### Back side of the teeth...

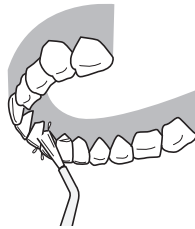

#### For the upper teeth

- Adjust the angle of the nozzle to face upward, and apply the stream perpendicular to the teeth.

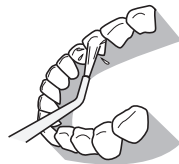

#### For the lower teeth

- Pull your chin down, and apply the stream perpendicular to the teeth.

- Do not apply the stream directly into the periodontal pockets.

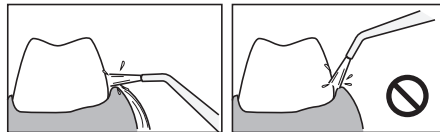

## After using the appliance

- There is a risk of bacteria propagating, so wash thoroughly and dry before storing.

- 1** Open the water supply cap and dispose of the water in the tank.



- 2** Turn the switch to ON, and drain the water inside the appliance.

- Run the appliance for 2 to 3 seconds until no water comes out.



- 3** Turn the switch to OFF.

- 4** Press the nozzle release button, remove the nozzle and place it in the storage compartment.

- 5** Store the main unit.

- Press it in until it clicks.
- Watch out not to clamp your fingers in the upper part of the tank.

- 6** Close the water supply cap.

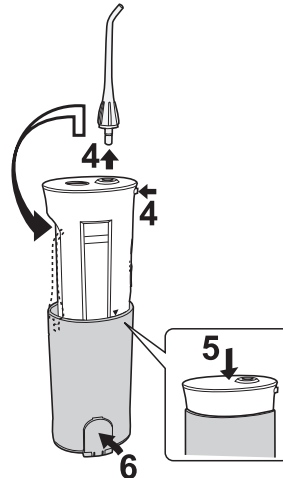

English

- To store in a bag or similar after using the appliance, wrap it in a towel or similar to absorb any excess water.
- To prevent bacteria propagating, take it out from a bag or similar as soon as possible to dry.

## Maintenance

### a Nozzle

(Remove it while pressing the nozzle release button.)

Wash with water and wipe with a cloth.

- Please replace the nozzle about once every 6 months. If the tip of nozzle gets deformed, please replace with a new nozzle. Failure to do so could result in malfunction.

### b Main unit

Remove the dirt by wiping using a cloth with liquid soap, and wipe off using a dry cloth.

Wash with water if it is very dirty.

- Do not wipe the appliance with thinners, benzine, alcohol etc.
- Doing so could result in malfunction, cracking or discoloration of the parts.
- Do not wash using hot water of over 50 °C.
- Make sure the battery cover is securely closed.
- Do not leave the appliance submerged in water.
- Dry after washing with water.

### c Water suction tube

Wash with water and wipe with a cloth.

- Do not bend the water suction tube.

Failure to do so could result in malfunction such as disruption in the operation of the water suction tube.

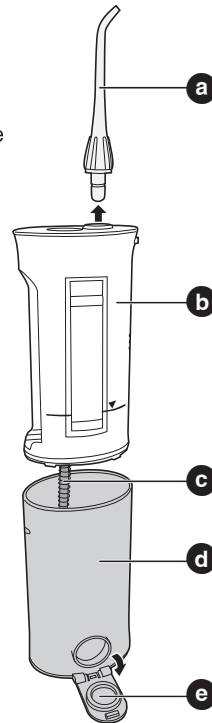

**d** Tank

It will come off when the body is pulled hard while the water supply cap is removed, so perform maintenance of interior as well.

Wash with water and wipe with a cloth.

- Wash the dirt off from inside using a brush or similar, and wipe off with a cloth.
- Dry the tank when not using for a long period.

**e** Water supply cap

Wipe off any grime and dirt.

- Failure to do so could result in water leakage.

- Only use mild detergent.
- Never use thinners, benzene, or alcohol since it may cause malfunction or cracking / discoloration of the parts.

**If you think it is malfunctioning**

Check the following.

Symptom	Probable Cause	Action
<b>It does not operate even when the switch is turned on</b>	Batteries are not inserted correctly	Insert the batteries correctly
	Batteries are dead	Replace with new batteries

Symptom	Probable Cause	Action
<b>Water pressure is low</b>	There is dirt stuck in the nozzle	Replace the nozzle
	Mouth of the nozzle is squashed	

Symptom	Probable Cause	Action
<b>Water does not come out</b>	The appliance is tilted too much while in use	Use with the appliance in a vertical state
	The main unit is not fully extended.	Pull out the main unit all the way

If the problem remains even after the appliance is checked and action is taken, terminate usage to prevent any accidents, and request checkup and repair at a store.

### Specifications

Power supply: 3.0 V DC (2 AA size alkaline batteries (LR6))

Weight: Approx. 210 g (without batteries)

### Accessories

Contact the stores close to you.

Check the "appliance product number (EW-DJ10)" and the "replacement nozzle product number" when purchasing.

Replacement nozzle (2 included)

**EW0955**

With identification ring

## 安全說明

本節所提供的所有資訊是為了指導您正確、安全地操作本器具，以避免您自己及他人受到傷害和財產損失。

■由使用不當所致的傷害或損害分類說明如下。

### 警告

表示“可能造成死亡或嚴重傷害的內容”。

### 注意

表示“可能造成傷害或財產損失的內容”。

■需要遵守的內容以下列圖示表示。(以下是各種圖示的示例)



帶斜線的圓圈表示禁止的動作和行為。



實心圓圈表示強制性措施和為確保安全操作而必須遵守的說明。

### 警告

 必須遵守！

• 避免嬰幼兒接觸。

否則會導致各種事故或紛擾，例如不慎吞入配件或可拆分零部件。

### 注意



禁止

• 嬰幼兒、無操作能力的人士、以及口腔感覺能力弱的人士不得使用本器具。

否則會受到傷害。

• 除口腔清潔外，請勿用於任何其他用途。

否則，水流噴向眼睛、鼻子、耳朵或咽喉時會受到傷害。如果您正在接受口腔治療或有嚴重的牙周病，請諮詢牙科醫生。

• 請勿在水箱內灌注超過 40°C 的水。

否則會導致燙傷。

 必須遵守！

• 保持器具的衛生，使用新鮮的自來水或溫水清潔口腔。

• 使用後，務必控出水箱內的水，然後運行本器具 2 至 3 秒將水排乾。

否則，在器具不衛生的情況下使用時，會由於黴菌或細菌的滋生而導致您的健康受到損害。此外，還會產生異味和故障。

• 遵守電池上標明的注意事項。

• 對準 + 和 - 端子，正確插入電池。

- 電池耗盡時應立即取出。
- 如果長時間不使用本器具，請取出電池。
- 按照推薦的有效期使用電池。  
否則，可能導致電池過熱或爆炸、受傷或由電池洩漏而導致周圍環境受到污染。
- ⚠ 請勿拆卸！
- 切勿改裝本器具。此外，請勿拆卸或修理。  
否則會導致起火、觸電或人身傷害。

### 注意

- 生理、感覺或心理能力欠佳或缺少經驗及知識的人士（包括兒童）不得使用本器具，除非他們得到其安全責任人在本器具使用方面的監督或指導。  
應對兒童進行監督，確保其不玩耍本器具。

## 部件識別

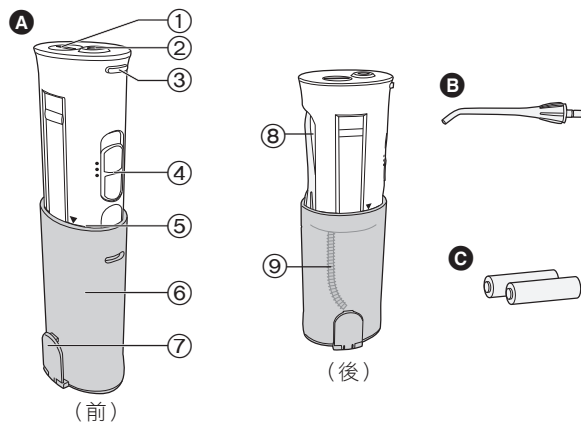

### A 主體

- ① 電池蓋
- ② 噴嘴插入孔
- ③ 噴嘴釋放按鈕
- ④ 開關
- ⑤ 使用線 (▼標記)
- ⑥ 水箱

### ⑦ 供水蓋

### ⑧ 噴嘴儲存艙

### ⑨ 吸水管

### B 噴嘴 (×1)

### C AA 尺寸鹼性電池 (×2)

### ▶ 註

主器具 (水箱、吸水管等) 內部可能存有一些液體，這是剩餘的用於性能 (水流) 檢驗的蒸餾水，因此不存在健康隱患。

### ▶ 使用本器具之前

即使是健康的牙齦，一開始也可能會出血。這是由於牙齦還不習慣這種刺激造成的，一般情況下，出血會在 1 周或 2 周內停止。如果出血持續時間超過 2 周，則可能是牙齦有問題 (牙周病等)。如果出現這種情況，請停止使用本器具並諮詢牙科醫生。

## 插入鹼性電池

• 擦拭本器具以免內部進水。

**1** 向 OPEN 轉動電池蓋，將其打開。

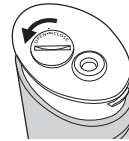

**2** 插入兩枚 AA 尺寸鹼性電池。

- 請使用 Panasonic 鹼性電池 (AA 尺寸)。  
(滿箱使用時可使用約 30 次，連續使用時  
可使用約 20 分鐘)
- 請勿使用充電電池。否則可能導致電池洩  
漏和故障。

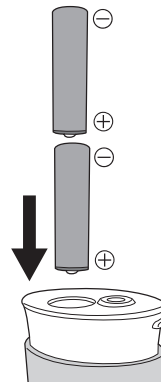

**3** 向 CLOSE 轉動電池蓋，將其關閉。

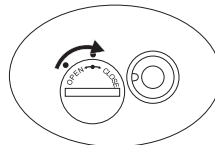

## 使用本器具

- 請使用水或溫水。
- 將噴嘴放入口中之前，請勿開啟開關。

### 1 打開供水蓋。

### 2 將主體的白色部分向上拔出至使用線（▼標記）。

- 供水蓋關閉時，主體部分可能難以拔出。
- 只有將主體拔到使用線，水壓才會升高。
- 此時，噴嘴可能會從儲存艙內彈出，因此應小心操作。

### 3 握住主體的白色部分，將噴嘴裝入噴嘴插入孔。

- 牢固插入噴嘴，直至其發出喀噠聲。

### 4 注入水。

- 務必使用新鮮的自來水。
- 如果感覺水涼，可使用不超過 40°C 的溫水。
- 請勿注入鹽、牙膏或化學製品。
- 為連續使用，請確保開關設為關閉。

### 5 關閉供水蓋。

- 注入水後，關緊供水蓋。

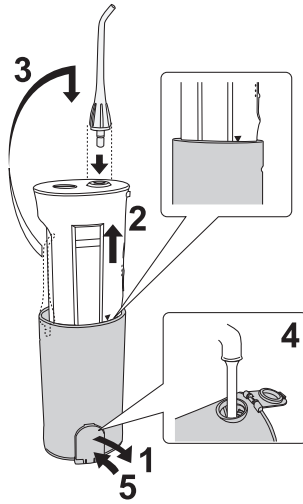

- 6 將噴嘴放入口中。**
- 器具過度傾斜時，水箱內的吸水管可能會脫離水面而導致水流停止。

- 7 開啟開關。**
- 滿箱可使用約 40 秒。
- 可以選擇模式（強度）。

**2（標準）**

- 用於正常清洗

**1（輕柔）**

- 對您的牙齦感到擔心時
- 感覺 2（標準）模式太強時

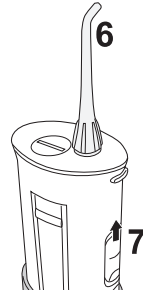

- 請勿使噴嘴的頂端緊貼牙齒或牙齦。
- 對於嬰幼兒等無法自己操作本器具的人士，或口腔敏感度較高的人士，應格外小心。
- 請勿跌落或粗暴對待本器具。
- 除排出器具中的水外，請勿空箱操作。否則會造成故障。

**► 小貼士**

- 使噴嘴朝上，豎直握住本器具。
- 將您的臉移到水槽上方。
- 略微合攏嘴以防止濺水。
- 將噴嘴放入口中。

## 充分清洗您的口腔

- 使水流盡可能垂直對準牙齒之間或牙齒與牙齦之間的邊緣噴射。
- 沿牙齒緩慢移動。
- 應格外留意牙齒之間和牙套周圍區域。

### 牙齒的前側...

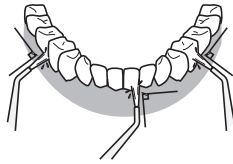

- 對牙齒垂直噴水。
- 應格外留意牙齒之間和牙齒與牙齦之間的邊緣。

### 牙齒的後側...

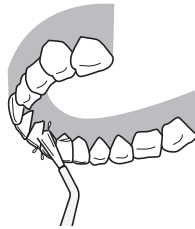

#### 上牙

- 將噴嘴的角度調整到朝上的方向，對牙齒垂直噴水。

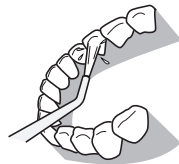

#### 下牙

- 降低下顎，對牙齒垂直噴水。

- 請勿直接向牙周囊袋內噴水。

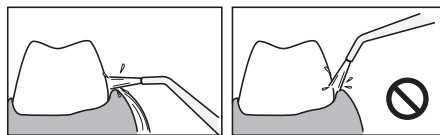

## 使用本器具之後

• 使用後可能會滋生細菌，因此，應在徹底清洗並乾燥後再存放。

**1** 打開供水蓋，控出水箱中的水。



**2** 開啟開關，將器具內部的水排乾。  
• 運行器具 2 至 3 秒，直至不再有水排出。



**3** 關閉開關。

**4** 按噴嘴釋放按鈕取出噴嘴，將其放到儲存艙內。

**5** 收納主體部分。

- 按主體部分，直至其發出喀噠聲。
- 小心不要讓水箱的上部擠傷手指。

**6** 關閉供水蓋。

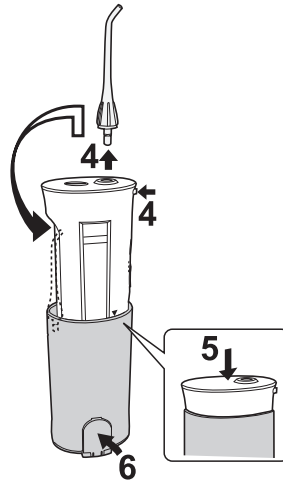

• 在使用器具之後將其存放在包內或類似物品內時，請將其裹在毛巾或類似物品中以吸收多餘的水分。

- 為防止細菌滋生，應儘早從包或類似物品中取出本器具將其晾乾。

## 維護

### a 噴嘴

(按住噴嘴釋放按鈕將其取出。)

用水清洗，然後用布擦拭。

- 每 6 個月左右請更換噴嘴。如果噴嘴的頂端已變形，請更換一個新的噴嘴。否則，會導致故障。

### b 主體

用蘸有液體肥皂的布擦掉污垢，然後用乾燥的布擦乾淨。

如果主體部分非常髒，可用水清洗。

- 請勿使用稀釋劑、汽油、酒精等擦拭本器具。
- 否則會造成故障，或零部件開裂或褪色。
- 請勿使用超過 50°C 的熱水清洗。
- 確保電池蓋已關緊。
- 請勿將器具浸沒在水中。
- 用水清洗後，擦乾淨水分。

### c 吸水管

用水清洗，然後用布擦拭。

- 請勿彎折吸水管。
- 否則會導致吸水管操作中斷等故障。

### d 水箱

在供水蓋拆下時用力拔機身，水箱會脫落，從而可以進行內部維護。

用水清洗，然後用布擦拭。

- 用刷子或類似物品洗掉污垢，然後用布擦乾淨。
- 長期不使用時請晾乾水箱。

### e 供水蓋

擦掉污垢。

- 否則會導致漏水。

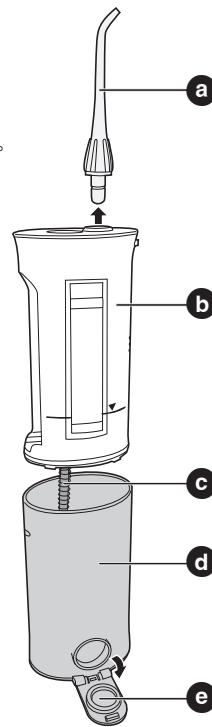

- 使用清潔劑時，應當使用溫和的清潔劑。
- 切勿使用稀釋劑、汽油或酒精，否則可能造成故障或零部件開裂 / 褪色。

### 如果您認為本器具發生故障

請進行以下檢查。

故障表現	可能的原因	糾正措施
即使開啟了開關，本器具也不工作。	未正確插入電池。	正確插入電池。
	電池已耗盡。	更換新電池。

故障表現	可能的原因	糾正措施
水壓低。	噴嘴內部被污垢阻塞。	更換噴嘴。
	噴嘴口已壓壞。	

故障表現	可能的原因	糾正措施
不出水。	器具使用時傾斜過度。	豎直使用器具。
	主體部分未充分拔出。	完全拔出主體部分。

如果在對器具進行檢查並採取相應措施之後問題依然存在，請停止使用以避免發生事故，然後到商店要求檢修。

## 規格

電源：直流 3.0V（2 枚 AA 尺寸鹼性電池（LR6））

重量：約 210g（不包括電池）

## 配件

請洽詢您附近的商店。

購買時，請核對“電器產品編號（EW-DJ10）”和“替換噴嘴產品編號”。

替換噴嘴（附 2 個）

**EW0955**

帶有標識環。

Panasonic Electric Works Wanbao (Guangzhou) Co., Ltd.  
<http://panasonic.net>

© EN, HK

Printed in China  
00000000 X0709-0