

**LIFAN POWER USA**



**ENGINES**

## **PREFACE**

Thank you for choosing a general gasoline engine by the company.

Based on the latest engine technology at home and abroad, our Co. has individually developed general gasoline engine with 4-stroke single cylinder, OHV and forced-air cooling. The engine is characterized by advanced design, compact structure, reliable performance, low noise and small vibration. It is widely used as ideal power in many fields such as small-scale water pump, generator set, cropper, thresher, garden machinery, etc.

The manual gives information with respect to operation and maintenance of the general gasoline engine. Please read it carefully first before operating. To extend the service life, users should strictly follow the stipulations stated in the manual to carry out operating and maintenance.

This manual should be considered a permanent part of the engine and should remain with it if it is resold.

All the materials and diagrams of this manual are in accordance with the newest products at the publishing time. Due to revision and other change, the information described in this manual may be a little different from the actual status. The copyright of this manual belongs to our Co, any group or individual is forbidden to reprint or copy any it. The manual is subject to change without notice.

Please pay special attention to statements preceded by the following words.

## **WARNING**

** A warning is used to alert the user to fact that hazardous operating and maintenance procedures may result in injury to or death of personnel if not strictly observed.**

## **CAUTION**

**A caution is used to alert the user to fact that hazardous operating and maintenance procedures may result in damage to or destruction of equipment if not strictly observed.**

## **NOTE**

**A note is used to give helpful information.**

Although the engine conforms to the safety requirement of EN1679-1, the user must notice the possible danger when they install the engine with other terminal products because the different installing purposes maybe will result in new danger to the engine and its driving product. So, all users must be responsible to take action for assuring the safety.

## CONTENTS

SAFETY PRECAUTIONS .....	1
PARTS DESCRIPTION .....	3
PRE-OPERATION IN SPECTION.....	4
STARTING THE ENGINE .....	7
STOPPING THE ENGINE .....	11
MAINTEMANCE.....	12
TRANSPORT AND STORAGE .....	19
TROUBLESHOOTING.....	21
SPECIFICATIONS .....	23

## **SAFETY PRECAUTIONS**



### **WARNING**

**Before operating the engine, be sure to read and familiar with the manual carefully, otherwise injury to personnel or damage to equipment may occur.**

Please pay special attention to the following:

1. Always make a pre – operation inspection before you start the engine. You may prevent an accident or equipment damage.
2. To prevent fire hazards and to provide adequate ventilation, keep the engine at 1 meter away from buildings and other equipment during operation. Do not place flammable objects close to the engine.
3. Children and pets must be kept away. From the area of operation due to a possibility of burns from hot engine components or injury from any equipment the engine may be used to operate.
4. Know how to stop the engine quickly, and understand the operation of all controls. Never permit anyone to operate the engine without proper instructions.
5. Do not place flammable objects such as gasoline, lighter, etc. Close to the engine while it is running.
6. Refuel in a well – ventilated area with the engine stopped.
7. Do not overfill the fuel tank. There should be no fuel in the filler neck.
8. After refueling, make sure that the filler cap is closed securely.

9. If any fuel is spilled, clean it up completely and make sure the area is dry before starting the engine.
10. Do not smoke or allow flames or sparks in the area where gasoline is stored or where the fuel tank is refueled.
11. Never run the engine in an enclosed area. The exhaust contains poisonous carbon monoxide (CO) gas that can cause loss of consciousness and lead to death.
12. Locate the engine on a firm working platform without an slant exceeding 20° to avoid fuel's spilling out.
13. Do not place any objects on the engine.
14. The exhaust muffler is very hot during running the engine even after the engine stops. Never touch it, or you may get burns. Transport or store the engine with it cooling down entirely.

## PARTS DESCRIPTION

The main parts of engine are located as follows (Fig.1)

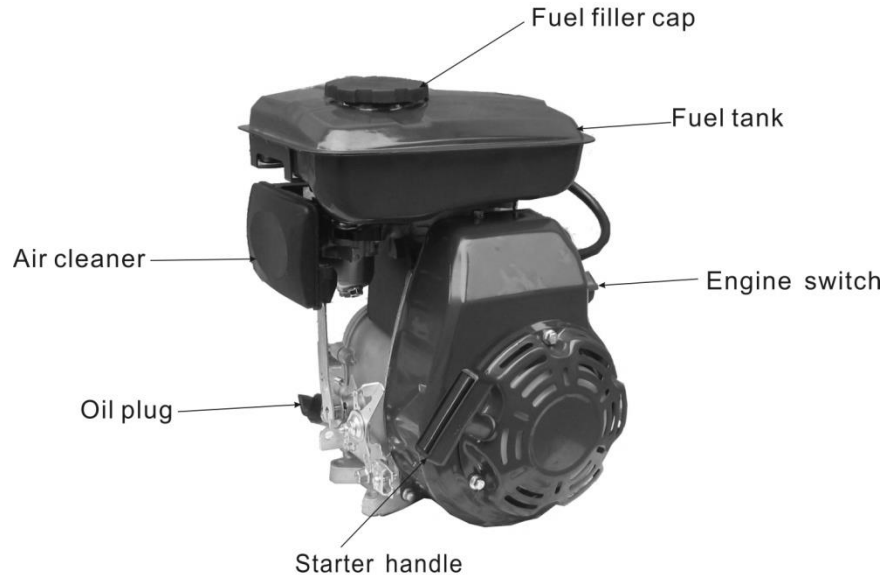

Fig. 1

## PRE – OPERATION INSPECTION

### I. ENGINE OIL

#### CAUTION

- Engine oil is a key factor in deciding the engine's performance. Do not apply engine oil with additives or 2 – stroke gasoline engine oil, as they haven't enough lubrication, which may shorten the engine's service life.
- Check the engine with it stopped on a level ground.

SAE10W – 30 (Fig.2) is recommended for general, all temperature use.

As viscosity varies with regions and temperatures, so the lubricant has to be selected in accordance with our recommendation. If single viscosity engine oil is to be used instead, its viscosity corresponding to average temperature of the region must be considered.

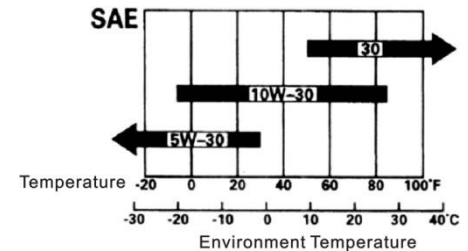

Fig.2

1. Ensure that the engine is stopped on a level ground.
2. Remove the dipstick and clean it.
3. Reinsert the dipstick into the oil filler without screwing in, and check oil level.
4. If the oil level is too low, add the recommended engine oil to the oil filler nick.
5. Reinstall the dipstick.

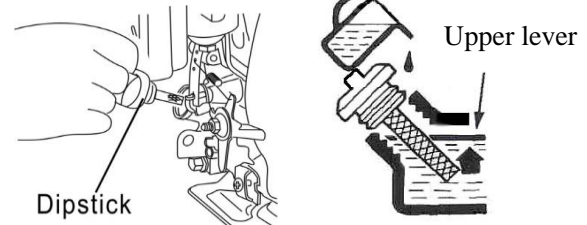

Fig.3

## **CAUTION**

**Run with insufficient engine oil may damage the engine severely.**

## **II. AIR CLEANER**

Check the filter element for dirt, and remove it if any.

## **CARTION**

**Never run the engine without an air cleaner, or severe wear of the engine may occur.**

## **III. FUEL AND FUEL TANK (Fig.4)**

### **1. Fuel**

The engine must apply unleaded gasoline or low – leaded gasoline. Using unleaded gasoline will decrease the possibility of producing carbon deposit and prolong the engine's service life.

Never use an oil gasoline mixture or dirty gasoline. Avoid getting dirt, dust or water in the fuel tank.

### **2. Fuel Tank**

Fuel tank capacity: 1.3 liters

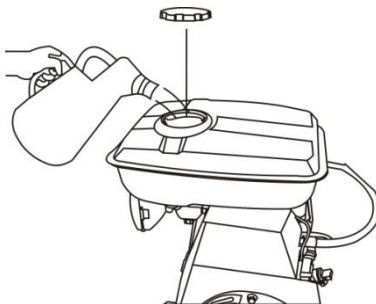

Fig.4

**⚠ WARNING**

- **Gasoline is extremely flammable and is explosive under certain conditions.**
- **Refueling in a well – ventilation area with the engine stopped. Do not smoke and allow flames or sparks in the area where gasoline is stored or where the fuel tank is refueled.**
- **Do not overfill the tank (there should be no fuel in the filler neck). After refueling, make sure the fuel tank cap is set back securely.**
- **Be careful not to spill fuel when refueling. Spilled fuel or fuel vapor may ignite. If any fuel is spilled, make sure the area is dry enough before starting the engine.**
- **Avoid repeated or prolonged contact with skin or breathing of fuel vapor.**
- **Keep out of reach of children.**

## STARTING THE ENGINE

1. Push the fuel cock to ON position (Fig.5).

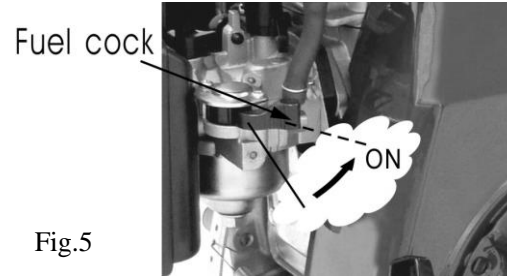

2. Push the choke lever to the OFF position (Fig. 6).

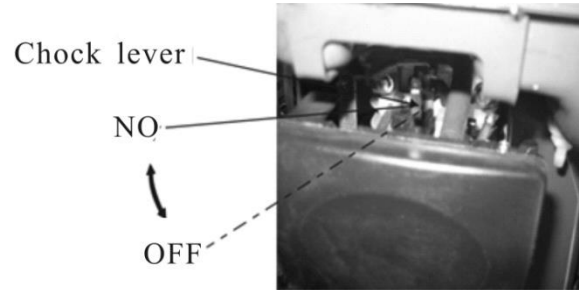

### NOTE

**Do not the choke if the engine is warm or the air temperature is high.**

3. Move down the throttle lever slightly to the FAST position (Fig. 7).

4. Start the engine (Fig. 8).

a) Push the engine switch to the ON position.

b) Pull slightly the starting rope handle up until feeling anti-action, and then make a rapid pull.

**CAUTION**

**Return the starting rope handle gently to prevent damage to the starter.**

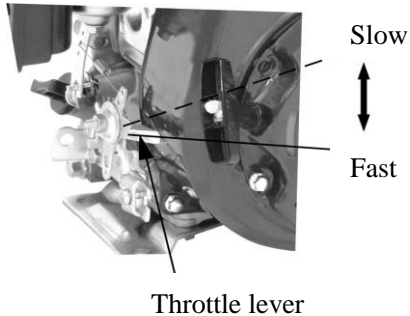

Fig.7

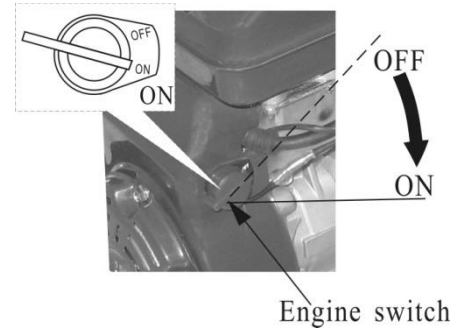
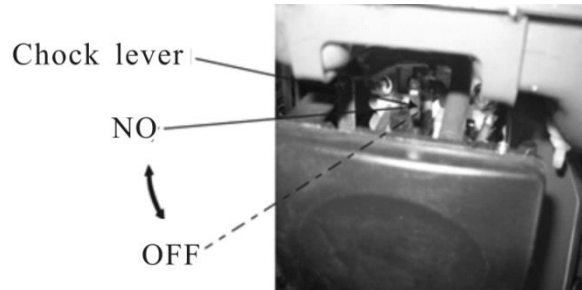

Fig.8

6. Gradually move the choke lever to the OPEN position. Warm up



the engine until it runs smoothly (Fig. 9).

Fig.9

7. Set the throttle lever in proper position to ensure the engine runs at required velocity (Fig. 10).

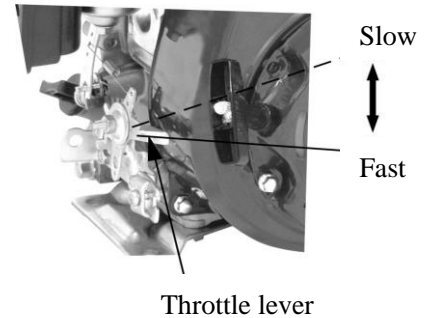

Fig.10

### ★ Operating on Highlands

On highlands, the standard carburetor air/fuel mixture is relatively too rich so the engine performance may be impaired while the fuel consumption may increase.

High altitude performance can be improved by installing a smaller diameter main fuel jet in the carburetor, and readjusting the idle needle screw and the idle adjust screw. If you always operate the engine at altitudes higher than 1830m above sea level, ask your dealer for adjusting the carburetor.

The engine power will decrease approximately 3.5% for every 305 meters increase in altitude, even the proper main jet of carburetor is used. The affect of altitude on power will be greater than this if no carburetor modification is conducted.

### **CAUTION**

**The engine equipped with the main jet applicable to highlands may be damaged seriously in area below specified altitude, because its mixture ratio is too lean, output drops and the engine overheats for operation in low altitude area. In the case, ask your dealer to recover the engine to its normal technical status.**

## STOPPING THE ENGINE

In an emergency, push the engine switch to “OFF” to stall the engine. Stop it in normal in the following sequence:

1. Push up the throttle lever to the SLOW position (Fig. 11).
2. Push the engine switch to the OFF position (Fig. 12).

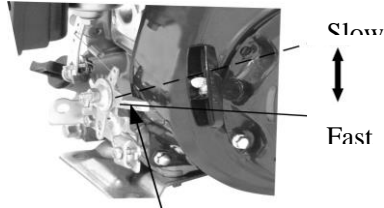

Throttle lever  
Fig.11

3. Set the fuel cock to the OFF position (Fig. 13).

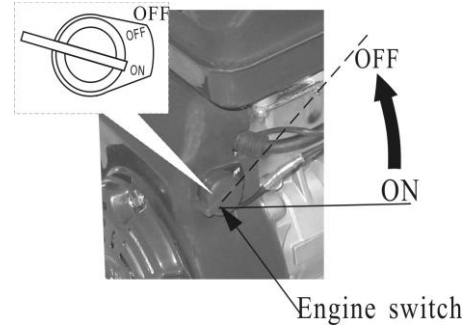

Fig.12

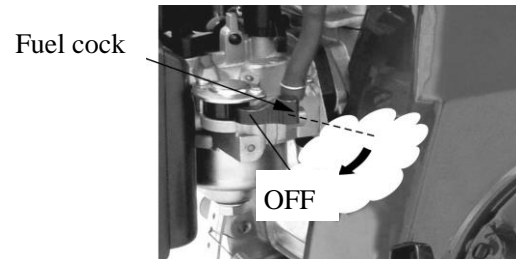

Fig.13

## MAINTENANCE



### WARNING

- Shut off the engine before performing any maintenance.
- To prevent accidental start – up, turn OFF the engine switch and disconnect the spark plug cap.
- The engine should be serviced by your dealer unless the owner has proper tools and service data and feels it is mechanically qualified.

### I . MAINTENANCE SCHEDULE

Periodic inspection and adjustment of the engine is essential if high level performance is to be maintained. Regular maintenance will also ensure a long service life. The required service intervals and the kind of maintenance to be performed are described on the table below.

### Maintenance Schedule

Item	Frequency	Each time	First month or 20 hrs	Each season or 50 hrs	Every 6-month or 100hrs	Each year or 300 hrs
Engine oil	Oil level check	✓				
	Replace		✓		✓	
Air cleaner	Check	✓				
	Clean					
Deposit cup	Clean			✓ ①	✓	
Spark plug	Check/Clean				✓	
Valve clearance	Clean					✓ ②
Combustion chamber	Clean					✓ ②
Fuel tank & fuel filter	Clean					✓ ②
Fuel supply line	Clean	Every two years (do a replacement if necessary) ②				

#### CAUTION

**Use only genuine parts manufactured by the company or equivalents in quality; otherwise damage to equipment may occur.**

#### NOTES

- ① The item should be serviced more often than that in the schedule if used in dusty circumstances.
- ② The items should be done by your dealer unless you are specially trained and is well equipped with tools.

## II .REPLACEMENT OF ENGINE OIL

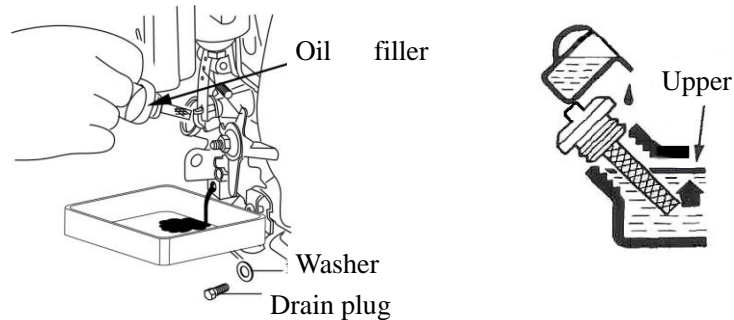

Fig.14

A still hot engine is helpful to drain out the engine oil in the crankcase rapidly and entirely.

- Turn off the oil filler cap and drain plug to drain engine oil thoroughly.
- Reinstall the drain plug and screw in securely.
- Fill the specified engine, and check the oil level.
- Reinstall the oil filler cap.

Engine oil capacity: 0.3L

### CAUTION

**Do not contact engine oil repeatedly for long – time, otherwise, it may cause skin cancer. Wash your hands with soap and water immediately after handling oil.**

## NOTE

**Do not dump oil containers or discarded engine oil into rubbish boxes or onto the ground .For the sake of environmental protection, we suggest you take in discarded engine oil with a closed container and bring to local recycling station.**

## III. SERVICE OF AIR CLEANER

A dirty air cleaner may block enough air's flowing into the carburetor. To prevent the carburetor from producing of trouble, please service the air cleaner periodically. If operating the engine in extremely dusty area, the job should be done more often.



### **WARNING**

**Never clean the air cleaner core in gasoline or low flash – point detergents, or explosion may happen.**

### **CAUTION**

**Never run the engine without an air cleaner, or air with dirt and dust may enter the engine so speed the engine's wear.**

1. Remove the air cleaner cover, take out the element.
2. Wash the element in a nonflammable or high flash point solvent and dry it thoroughly.
3. Soak the element in clean engine oil until it becomes saturated, and then squeeze out the excess oil.
4. Install the removed parts in the reverse order of removal.

#### IV. WASHING OF DEPOSIT CUP

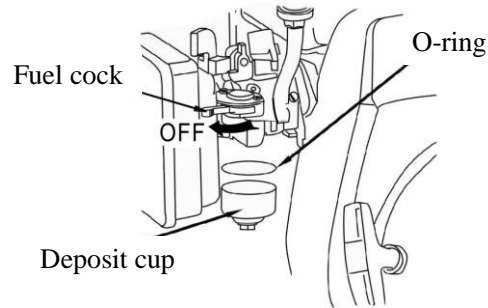

Fig.15

Set the fuel cock at “OFF” , remove the deposit cup and O – ring, Wash them in nonflammable or high flash point cleansing solvents, and then dry them up, at last , carry out reinstallation. Set the fuel cock to “ON” and check for leaks.

#### **⚠ WARNING**

- **Gasoline is extremely flammable and explosive in certain conditions. Keep cigarette, sparks and open flames away.**
- **After reinstalling the deposit cup, check it for leakage and make sure the area around the engine is dry enough.**

#### V. SPARK PLUG

Spark plug recommended: 255

Proper spark plug clearance ensures the engine’s normal running under no deposit around the spark plug.

1. Remove the spark plug by means of spark plug wrench (Fig. 16).

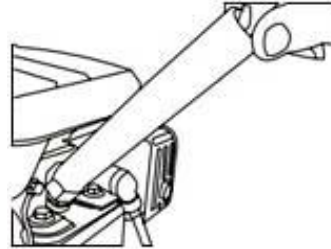

Fig.16

**⚠ WARNING**

**Be careful not to touch the muffler and the spark plug during or just after running the engine.**

2. Visually inspect the spark plug. Clean the spark plug with a steel brush. If the insulator is cracked or chipped, or if there is apparent wear, replace the spark plug with new one.
3. Measure the spark plug clearance with a feeler. The clearance should be 0.6~0.7mm (Fig. 17). If adjustment is necessary, bend the side electrode carefully.

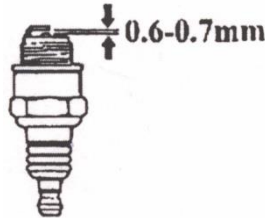

Fig.17

4. Check if the spark plug gasket is in good conditions, or replace with a new one. Screw on the spark plug to the bottom first by hand to prevent cross – threading (Fig. 18)

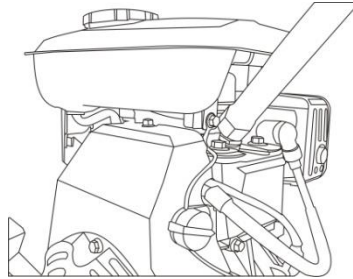

Fig. 18

5. After the spark plug is seated, tighten it up by a spark plug wrench to compress the gasket.

#### **NOTE**

If a new spark plug is used, twist  $1/2$  more turns after impacting the gasket; if reinstall the original one, just twist  $1/8$ ~ $1/4$  more turns.

#### **CAUTION**

- **The spark plug must be tightened securely, or it may become very hot to damage the engine.**
- **Only use recommended spark plug or the equivalent. Incorrect heat range of the spark plug may damage the engine.**

## TRANSPORT AND STORAGE

### I. TRANSPORT

Transport with the fuel cock turned off. Transport or store the engine when it is cool so as to avoid getting burns or fire.

#### CAUTION

**Do not incline the engine so as to avoid spilling fuel. Spilled fuel or fuel vapor may ignite to cause fire.**

### II. STORAGE

Before storing the engine for an extended period:

1. Be sure the storage area is free of excessive humidity and dust.
2. Drain the fuel as follows:

#### WARNING

**Gasoline is extremely flammable and is explosive under certain conditions. Do not smoke or allow flames or sparks in the area.**

- a) Set the fuel cock to the OFF position, remove the deposit cup and clean it.
  - b) Set the fuel cock to the ON position, and drain the fuel into the container.
  - c) Install the deposit cup to the original position.
  - d) Loosen the carburetor drain screw to drain the fuel into the container.
3. Change the engine oil.
  4. Remove the spark plug and pour about a tablespoon of clean engine oil into the cylinder. Crank the engine several

revolutions to scatter evenly the oil inside the cylinder, then reinstall the spark plug.

5. Pull the starter rope slowly until resistance is felt, thus closing the valve. Such operation prevents getting of dust or protects the cylinder well from rusting.
6. Cover the engine to keep out dust.

## TROUBLESHOOTING

When the engine will not start with the recoil starter:

1. Is the engine switch in the ON position?
2. Is there engine oil enough?
3. Is there fuel cock in the ON position?
4. Is there fuel in the fuel tank?
5. Is gasoline reaching the carburetor?

To check, loosen the carburetor drain screw and set the cock to the ON position .

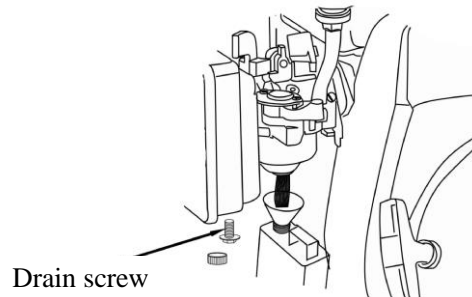

Fig.19



### WARNING

**If any fuel is spilled, make sure that the area is dry before checking the spark plug or starting the engine.  
Spilled fuel or fuel vapor may ignite.**

6. Is there a spark the spark plug?

- a) Disconnect the spark plug cap. Clean any dirt from around the spark plug base, then remove the spark plug.
- b) Install the cap onto the spark plug.
- c) Grounding the side electrode to the engine body, pull the recoil starter to see if sparks jump across the gap.
- d) Once you find any of above problems, contact the authorization, entitle to the dealer of the privilege helps for you.

## SPECIFICATIONS

### Gasoline Engine

Model	152F-3
Type	Single cylinder, 4 – stroke, OHV
Displacement	79.4cm <sup>3</sup>
Bore × Stroke	52×37.4
1h output	1.1kW/3600r/min
Max. torque	3.1N.m/3240r/min
Fuel consumption	≤450g/kW.h
Cooling system	Forced air
Ignition system	Non contact transistor magneto
PTO shaft rotation	Counterclockwise
Length	270mm
Width	267mm
Height	339mm
Dry weight	9.2kg



**2205 Industrial Park Road  
Van Buren, AR 72956**

**(866) 471-7464**

**[www.lifanpowerusa.com](http://www.lifanpowerusa.com)**