

The Traveler Series™ : Wanderer

30A PWM
Solar Charge Controller



 **RENOGY**

Version 1.0

Important Safety Instructions

Please save these instructions.

This manual contains important safety, installation, and operating instructions for the charge controller. The following symbols are used throughout the manual:

WARNING

Indicates a potentially dangerous condition. Use extreme caution when performing this task

CAUTION

Indicates a critical procedure for safe and proper operation of the controller

NOTE

Indicates a procedure or function that is important to the safe and proper operation of the controller

General Safety Information

- Read all of the instructions and cautions in the manual before beginning the installation.
- There are no serviceable parts for this controller. Do **NOT** disassemble or attempt to repair the controller.
- Make sure all connections going into and from the controller are tight. There may be sparks when making connections, therefore, make sure there are not flammable materials or gases near installation.

Charge Controller Safety

- **NEVER** connect the solar panel array to the controller without a battery. Battery must be connected first. This may cause a dangerous occurrence where the controller would experience a high open circuit voltage at the terminals.
- Ensure input voltage does not exceed **50 VDC** to prevent permanent damage. Use the Open Circuit (Voc) to make sure the voltage does not exceed this value when connecting panels together in series.
- The charge controller should be installed indoors in a well-ventilated, cool, and dry environment.
- Do **NOT** allow water to enter the controller.

Battery Safety

- Do **NOT** let the positive (+) and negative (-) terminals of the battery touch each other.
- Use only sealed lead-acid, flooded, gel or lithium batteries which must be deep cycle.
- Explosive battery gases may be present while charging. Be certain there is enough ventilation to release the gases.
- Be careful when working with large lead acid batteries. Wear eye protection and have fresh water available in case there is contact with the battery acid.
- Over-charging and excessive gas precipitation may damage the battery plates and activate material shedding on them. Too high of an equalizing charge or too long of one may cause damage. Please carefully review the specific requirements of the battery used in the system.
- Equalization is carried out only for non-sealed / vented / flooded / wet cell lead acid batteries.
- Do **NOT** equalize VRLA type AGM / GEL / LITHIUM batteries **UNLESS** permitted by battery manufacturer.
- Default charging parameters in Li mode are programmed for 12.8V Lithium Iron Phosphate (LFP) Battery only. Before using Wanderer to charge other types of lithium battery, set the parameters according to the suggestions from battery manufacturer.

WARNING

Connect battery terminals to the charge controller **BEFORE** connecting the solar panel(s) to the charge controller. **NEVER** connect solar panels to charge controller until the battery is connected.

Table of Contents

General Information	04
Optional Components	06
Identification of Parts	07
Installation	07
Mounting Recommendations	07
Operation	10
LED Indicators	10
System Status Troubleshooting	11
Maintenance	12
Fusing	12
Technical Specifications	13
Electrical Specifications	13
Battery Charging Parameters	13
Dimensions	14

General Information

The Wanderer is an advanced charge controller for off-grid solar applications and can be used with a 12V battery or battery bank. Integrating highly efficient PWM charging, the Wanderer increases battery life and improves system performance. The controller comes equipped with fully comprehensive self-diagnostics and electronic protection functions to prevent damage from installation mistakes or system faults.

Key Features

- Optimized for 12 VDC system voltage
- 30A charging capacity.
- Deep Cycle Sealed, Gel, Flooded and Lithium battery options.
- 4 Stage PWM charging: Bulk, Boost, Float, and Equalization
- Temperature compensation and correcting the charging and discharging parameters automatically, improving battery lifetime.
- Protection against: reverse current, overcharging, short-circuit and reverse polarity.
- Negative ground controller
- Multiple LED indicators for easy to read charge status and battery information.
- Remote temperature compensation compatible (accessory sold separately)
- Integrated communication port for remote monitoring.
- Charges over-discharged lithium batteries.

PWM Technology

The Wanderer utilizes Pulse Width Modulation (PWM) technology for battery charging. Battery charging is a current based process so controlling the current will control the battery voltage. For the most accurate return of capacity, and for the prevention of excessive gassing pressure, the battery is required to be controlled by specified voltage regulation set points for Absorption, Float, and Equalization charging stages. The charge controller uses automatic duty cycle conversion, creating pulses of current to charge the battery. The duty cycle is proportional to the difference between the sensed battery voltage and the specified voltage regulation set point. Once the battery reached the specified voltage range, pulse current charging mode allows the battery to react and allows for an acceptable rate of charge for the battery level. The Wanderer has a 4-stage battery charging algorithm for a rapid, efficient, and safe battery charging. They include: Bulk Charge, Boost Charge, Float Charge, and Equalization.

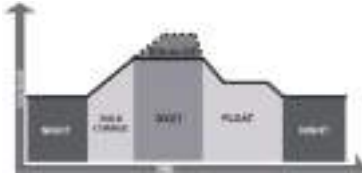

Bulk Charge: This algorithm is used for day to day charging. It uses 100% of available solar power to recharge the battery and is equivalent to constant current.

Boost Charge: When the battery has charged to the Boost voltage set-point, it undergoes an absorption stage which is equivalent to constant voltage regulation to prevent heating and excessive gassing in the battery. The Boost time is 120 minutes.

Float Charge: After Boost Charge, the controller will reduce the battery voltage to a float voltage set point. Once the battery is fully charged, there will be no more chemical reactions and all the charge current would turn into heat or gas. Because of this, the charge controller will reduce the voltage charge to smaller quantity, while lightly charging the battery. The purpose for this is to offset the power consumption while maintaining a full battery storage capacity. In the event that a load drawn from the battery exceeds the charge current, the controller will no longer be able to maintain the battery to a Float set point and the controller will end the float charge stage and refer back to bulk charging.

Equalization: Is carried out every 28 days of the month. It is intentional overcharging of the battery for a controlled period of time. Certain types of batteries benefit from periodic equalizing charge, which can stir the electrolyte, balance battery voltage and complete chemical reaction. Equalizing charge increases the battery voltage, higher than the standard complement voltage, which gasifies the battery electrolyte.

WARNING

Once equalization is active in the battery charging, it will not exit this stage unless there is adequate charging current from the solar panel. There should be NO load on the batteries when in equalization charging stage.

WARNING

Over-charging and excessive gas precipitation may damage the battery plates and activate material shedding on them. Too high of equalizing charge or for too long may cause damage. Please carefully review the specific requirements of the battery used in the system.

Lithium Battery Activation

The Wanderer PWM charge controller has a reactivation feature to awaken a sleeping lithium battery. The protection circuit of lithium battery will typically turn the battery off and make it unusable if over-discharged. This can happen when storing a lithium battery pack in a discharged state for any length of time as self-discharge would gradually deplete the remaining charge. Without the wake-up feature to reactivate and recharge batteries, these batteries would become unserviceable and the packs would be discarded. The Wanderer will apply a small charge current to activate the protection circuit and if a correct cell voltage can be reached, it starts a normal charge.

Optional Components

The Wanderer is shipped with by itself with no additional components. Optional components that require a separate purchase:



Remote Temperature Sensor (TS-R):

Measures the temperature at the battery and uses this data for very accurate temperature compensation. The sensor is supplied with a 6.6ft cable length that connects to the charge controller.



BT-1 Bluetooth Module:

The BT-1 Bluetooth module is a great addition to any Renogy charge controllers with a RS232 port and is used to pair charge controllers with the Renogy BT App. After pairing is done you can monitor your system and change parameters directly from you cell phone or tablet. No more wondering how your system is performing, now you can see performance in real time without the need of checking on the controller's LCD.

Identification of Parts

Key Parts

1. Battery Select Button
2. Battery Type Indicator
3. Battery Indicator
4. PV Indicator
5. Remote Temperature Sensor Port (optional accessory)
6. PV Terminals
7. Battery Terminals
8. RS-232 Port (optional accessory)



Installation

WARNING

Connect battery terminal wires to the charge controller **FIRST** then connect the solar panel(s) to the charge controller. **NEVER** connect solar panel to charge controller before the battery.

CAUTION

Do not over-torque or over tighten the screw terminals. This could potentially break the piece that holds the wire to the charge controller.

Refer to the technical specifications for max wire sizes on the controller and for the maximum amperage going through wires.

Mounting Recommendations:

WARNING

Never install the controller in a sealed enclosure with flooded batteries. Gas can accumulate and there is a risk of explosion.

1. **Choose Mounting Location**—place the controller on a vertical surface protected from direct sunlight, high temperatures, and water. Make sure there is good ventilation.
2. **Check for Clearance**—verify that there is sufficient room to run wires, as well as clearance above and below the controller for ventilation. The clearance should be at least 6 inches (150mm).
3. **Mark Holes**
4. **Drill Holes**

NOTE

The Wanderer is not equipped with screws for wall mounting.

5. **Secure the charge controller.**

Battery

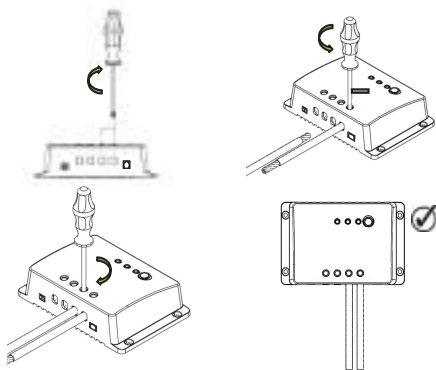

Solar Panel

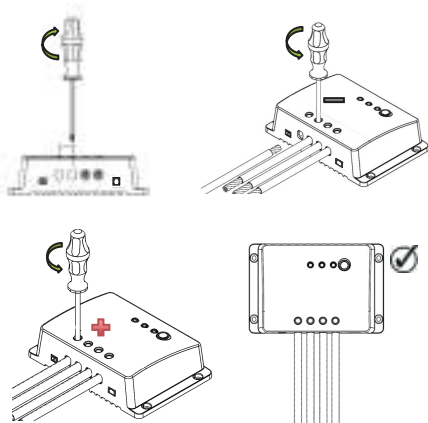

Bluetooth Module Communication (optional)

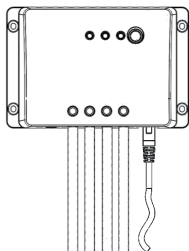

Temperature Sensor (optional, not polarity sensitive)

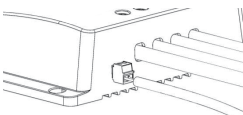
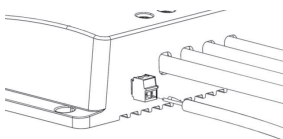
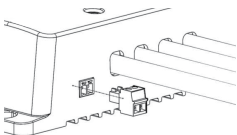

Place the sensor close to the battery



Operation

After connecting the battery to the charge controller, the controller will turn on automatically. Operation of this controller is very simply. Users set the battery type, and leave the rest of the work to the charge controller.

Setting Battery Type

Simply hold the gray button for approximately 7 seconds until the LED flashes. Once flashing, then press the gray button again to the desired battery type (they are color coded) and simply leave the controller alone until the flashing stops (this should take approximately 10 seconds). This indicates the parameter has been set.

NOTE











If the LED lights do not flash, hold the gray button for 7 seconds again, release, and immediately press the gray button again to enable the flashing.

Set Battery Type

**Sealed****Gel****Flooded****Li**

LED Indicators

The Wanderer is a simple to use controller requiring little to no maintenance. Users can be informed about the charge controller's status based on the LED indicators at the PV and Battery levels. The following chart goes into further detail regarding the Wanderer's indicators.

PV Indicator	BATT Indicator	Controller Status
 Fast Flashing	n/a	PV terminal is <u>over-voltage</u>
 Solid	n/a	PV terminal <u>low output</u>
 Slow Flashing	 Solid	Battery is <u>charging normally</u>
 Slow Flashing	 Slow Flashing	The battery is in <u>float charge</u>
n/a	 Fast Flashing	The battery is <u>over-voltage</u>
n/a	 Solid	The battery is <u>under-voltage</u>
n/a	 Solid	The battery is <u>over-discharged</u>
n/a	 Slow Flashing	The battery is <u>over-heating</u>

System Status Troubleshooting

Description	Troubleshoot
Battery is low-voltage	Use a multi-meter to verify the rated battery voltage. Disconnect any loads connected to the battery to allow it to charge.
Battery is over-voltage	Use a multi-meter to check the voltage of the battery. Make sure the battery voltage is not exceeding the rated specification of the charge controller. Disconnect battery.
PV is over-voltage	Use a multi-meter to check the voltage of the panels. Ensure that they meet the specification of the controller to not exceed 25 VDC.
PV terminal low output	The PV output is typically lower in the early mornings and in the late afternoons. This should not require troubleshooting unless a solar panel is defective.
Battery is over-heating	When heat is exceeding the specification of the controller, it will automatically shut down. The controller will resume to operate once it interprets a change in temperature.
Other Considerations	
Charge controller does not charge during daytime when the sun is shining on the solar panels.	Confirm that there is a tight and correct connection from the battery bank to the charge controller and the solar panels to the charge controller. Use a multi-meter to check if the polarity of the solar modules have been reversed on the charge controller's solar terminals.
No LED indicator when battery is connected to the charge controller	The battery voltage may be less than 9V. A minimum of 9V is required to power on the controller.
Battery LED light does not flash when holding for 7 seconds.	The battery selection LED must be enabled. Disconnect the battery from the controller, then connect the battery to the controller to reset it. Then hold the gray button for 7 seconds, release the button, and then immediately press the gray button one more time to select a battery type.

Maintenance

For best controller performance, it is recommended that these tasks be performed from time to time.

1. Check that controller is mounted in a clean, dry, and ventilated area.
2. Check wiring going into the charge controller and make sure there is no wire damage or wear.
3. Tighten all terminals and inspect any loose, broken, or burnt up connections.

Fusing

NEC Maximum Current for different Copper Wire Sizes

AWG	16	14	12	10	8	6	4	2	0
Max. Current	10A	15A	20A	30A	55A	75A	95A	130A	170A

Fuse from Controller to Battery

Controller to Battery Fuse = Current Rating of Charge Controller

Ex. 30A Wanderer = 30A fuse from Controller to Battery

Fuse from Solar Panel(s) to Controller

Ex. 200W; 2 X 100 W panels

Parallel

Total Amperage = $I_{sc1} + I_{sc2} = (5.75A + 5.75A) * 1.56$

Fuse = minimum of $11.5 * 1.56 = 17.94 = \underline{18A \text{ fuse}}$

Technical Specifications

Electrical Specifications

Description	Parameter
Nominal system voltage	12 VDC
Rated Charge Current	30A
Max. PV Input Voltage	25 VDC
Self-Consumption	≤10mA
Temp. Compensation	-3mV/°C/2V
Max. Terminal Size	10mm 8 [#] AWG
Working Temperature	-35°C to +45°C / -20°F to 113°F
Net Weight	0.29 kg 0.65 lb.
Dimensions	163.83 x 109.62 x 44.7mm 6.45 x 4.31 x 1.76in
Enclosure	IP20
Communication	RS232
Certification	FC CE RoHS

Battery Charging Parameters

Battery	GEL	SEALED	FLOODED	LI (LEP)
High Voltage Disconnect	16 V	16 V	16 V	16 V
Charging Limit Voltage	15.5 V	15.5 V	15.5 V	15.5 V
Equalization Voltage	----	14.6 V	14.8 V	----
Boost Voltage	14.2 V	14.4 V	14.6 V	14.2 V (User:12.6-16V)
Float Voltage	13.8 V	13.8 V	13.2 V	----
Boost Return Voltage	13.2 V	13.2 V	13.2 V	13.2 V
Low Voltage Reconnect	12.6 V	12.6 V	12.6 V	12.6 V
Under Voltage Recover	12.2V	12.2V	12.2V	12.2V
Under Voltage Warning	12V	12V	12V	12V
Low Voltage Disconnect	11.1V	11.1V	11.1V	11.1V
Discharging Limit Voltage	10.8V	10.8V	10.8V	10.8V
Equalization Duration	----	2 hours	2 hours	----
Boost Duration	2 hours	2 hours	2 hours	----

* Battery charging parameters in LI mode can be programmed using Renogy BT App.

** Default charging parameters in LI mode are programmed for 12.8V LFP battery. Before using Wanderer to charge other types of lithium battery, set the parameters according to the suggestions from battery manufacturer.

Dimensions

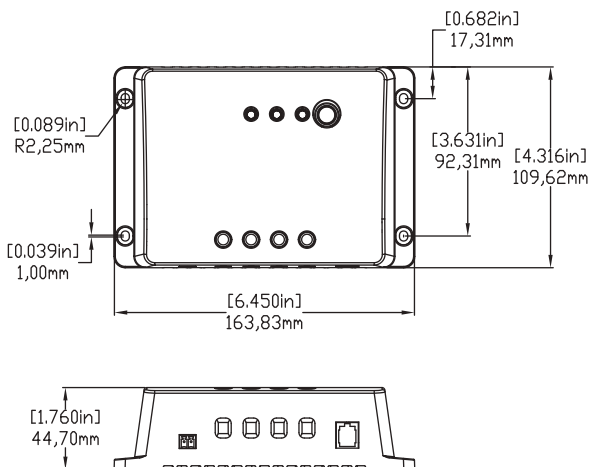



2775 E. Philadelphia St., Ontario, CA 91761
1-800-330-8678

Renogy reserves the right to change the contents of this manual without notice.