



Dell SE2419H/SE2419HX/ SE2719H/SE2719HX User's Guide

Monitor Model: SE2419H/SE2419HX/SE2719H/SE2719HX
Regulatory model: SE2419Hf, SE2719Hf



Notes, Cautions and Warnings

-  **NOTE:** A NOTE indicates important information that helps you make better use of your computer.
-  **CAUTION:** A CAUTION indicates potential damage to hardware or loss of data if instructions are not followed.
-  **WARNING:** A WARNING indicates a potential for property damage, personal injury, or death.

Copyright © 2018 - 2019 Dell Inc. or its subsidiaries. All rights reserved. Dell, EMC, and other trademarks are trademarks of Dell Inc. or its subsidiaries. Other trademarks may be trademarks of their respective owners.

2019 – 09

Rev. A02

Contents

About your monitor	5
Package contents	5
Product features	6
Identifying features and controls	7
Monitor specifications	10
Plug and play capability	17
LCD monitor quality and pixel policy	17
Maintenance guidelines	17
Setting up the monitor	18
Connecting the stand	18
Connecting your monitor	20
Organizing cables	21
Removing the stand	21
Operating your monitor	23
Turning on the monitor	23
Using the front panel controls	23
Using the On-Screen Display (OSD) menu	25
Setting up your monitor	47
Using tilt	49

Troubleshooting	50
Self-test	50
Built-in diagnostics	52
Common problems	53
Product-specific problems	55
Appendix	56
FCC notices (U.S. Only) and other regulatory information	56
Contacting Dell	56
Pin assignments	57

About your monitor



Package contents

Your monitor ships with the components indicated in the table. Ensure that you have received all the components and see [Contacting Dell](#) if anything is missing.

 **NOTE: Some items may be optional and may not ship with your monitor. Some features may not be available in certain countries.**

 **NOTE: To set up with any other stand, see the documentation that shipped with the stand.**

	Monitor
	Stand riser
	Stand base
	Power cable (varies by country)
	VGA cable (SE2419H and SE2719H)

	<p>HDMI cable (SE2419HX and SE2719HX)</p>
	<ul style="list-style-type: none"> • Quick Setup Guide • Safety and Regulatory Information

Product features

The Dell SE2419H/SE2419HX/SE2719H/SE2719HX flat panel display has an active matrix, Thin-Film Transistor (TFT), Liquid Crystal Display (LCD), anti-static, and LED backlight. The monitor features include:

- SE2419H/SE2419HX: 60.45 cm (23.8 inch) diagonal viewable area display (measured diagonally). 1920 x 1080 resolution, with full-screen support for lower resolutions.
- SE2719H/SE2719HX: 68.58 cm (27 inch) diagonal viewable area display (measured diagonally). 1920 x 1080 resolution, with full-screen support for lower resolutions.
- Wide viewing angles of 178 degrees in vertical and horizontal directions.
- High dynamic contrast ratio (8,000,000:1).
- HDMI connectivity makes it simple and easy to connect with legacy and new systems.
- Plug and play capable if supported by your computer
- On-Screen Display (OSD) adjustments for easy setup and screen optimization.
- 0.5 W standby power when in the sleep mode.
- Optimize eye comfort with a flicker-free screen.
- Possible long-term effects if blue light emission from the monitor may cause damage to the eyes, including eye fatigue or digital eye strain. ComfortView feature is designed to reduce the amount of blue light emitted from the monitor to help optimize eye comfort.
- Security-lock slot.
- Arsenic-free glass and mercury-free panel.
- BFR/PVC-Reduced (the circuit boards inside your monitor are made using BFR/PVC-free laminates).
- RoHS Compliant.

Identifying features and controls

Front view

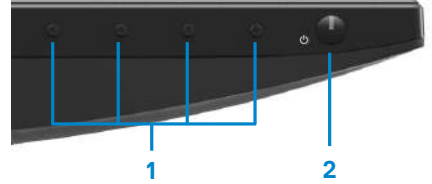

Label	Description	Use
1	Function buttons	To access the OSD menu and change the settings if required. (For more information, see Using the front panel controls)
2	Power On/Off button (with LED indicator)	To turn the monitor On or Off.

Back view



Without monitor stand

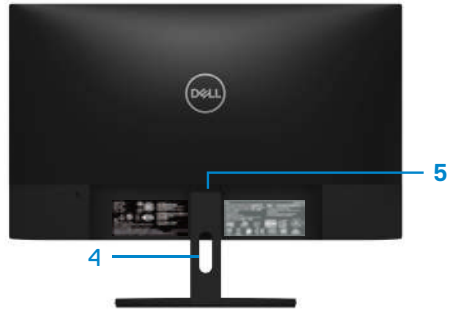

With monitor stand

Label	Description	Use
1	Security-lock slot	To secure the monitor using a security lock (purchased separately).
2	Regulatory label, barcode, serial number, and Service Tag label	List the regulatory approvals. See this label if you need to contact Dell for technical support. The Service Tag is a unique alphanumeric identifier that enables Dell service technicians to identify the hardware components in your computer and access warranty information.
3	Regulatory information (engraved)	List the regulatory approvals.
4	Cable-management slot	To organize the cables.
5	Stand release button	Release stand from monitor.

Side view



Bottom view, without monitor stand



SE2419H/SE2419HX/SE2719H/SE2719HX

Label	Description	Use
1	Power port	To connect the monitor power cable.
2	HDMI port	For connection to your computer using HDMI cable.
3	VGA port	For connection to your computer using VGA cable.

Monitor specifications

Model	SE2419H/SE2419HX	SE2719H/SE2719HX
Screen type	Active matrix-TFT LCD	
Panel type	In-Plane Switching	
Viewable area		
Diagonal	604.70 mm (23.81 in.)	686.00 mm (27 in.)
Active area:		
Horizontal	527.04 mm (20.75 in.)	597.89 mm (23.54 in.)
Vertical	296.46 mm (11.67 in.)	336.31 mm (13.24 in.)
Area	1562.46 cm ² (242.15 in. ²)	2010.76 cm ² (311.67 in. ²)
Pixel pitch	0.2745 mm	0.3114 mm
Pixel per inch (PPI)	92	81
Viewing angle:		
Vertical	178° (typical)	
Horizontal	178° (typical)	
Brightness	250 cd/m ² (typical)	300 cd/m ² (typical)
Contrast ratio	1,000 to 1 (typical) 8,000,000 to 1 (Dynamic Contrast)	
Faceplate coating	Anti-glare with 3H hardness	
Backlight	LED edgelight system	
Response time (Gray to Gray):		
Normal mode	8 ms	
Fast mode	5 ms	
Color depth	16.7 million colors	
Color gamut	CIE 1931 (72%)	
Dell display manager compatibility	Yes	
Connectivity	• One VGA port and one HDMI 1.4 (HDCP 1.4) port with SE2419H/SE2419HX/SE2719H/SE2719HX monitors.	
Bezel width (edge of monitor to active area)	6.2 mm (Top) 6.2 mm (Left/Right) 20.5 mm (Bottom)	6.8 mm (Top) 6.8 mm (Left/Right) 21.1 mm (Bottom)
Security	Security-lock slot for cable lock (optional purchase)	
Tilt angle	-5° to 21°	

Resolution specifications

Model	SE2419H/SE2419HX	SE2719H/SE2719HX
Horizontal scan range	30 kHz to 83 kHz (automatic)	
Vertical scan range	56 Hz to 76 Hz (automatic)	
Maximum preset resolution	1920 x 1080 at 60 Hz	

Preset display modes

SE2419H/SE2419HX/SE2719H/SE2719HX

Display Mode	Horizontal Frequency (kHz)	Vertical Frequency (Hz)	Pixel Clock (MHz)	Sync Polarity (Horizontal / Vertical)
VESA, 720 x 400	31.5	70.1	28.3	-/+
VESA, 640 x 480	31.5	60.0	25.2	-/-
VESA, 640 x 480	37.5	75.0	31.5	-/-
VESA, 800 x 600	37.9	60.3	40.0	+/+
VESA, 800 x 600	46.9	75.0	49.5	+/+
VESA, 1024 x 768	48.4	60.0	65.0	-/-
VESA, 1024 x 768	60.0	75.0	78.8	+/+
VESA, 1152 x 864	67.5	75.0	108.0	+/+
VESA, 1280 x 1024	64.0	60.0	108.0	+/+
VESA, 1280 x 1024	80.0	75.0	135.0	+/+
VESA, 1600 x 900	60.0	60.0	108.0	+/+
VESA, 1920 x 1080	67.5	60.0	148.5	+/+

Electrical specifications

Model	SE2419H/SE2419HX SE2719H/SE2719HX
Video input signals	<ul style="list-style-type: none"> • Analog RGB: 0.7 Volts \pm 5 %, 75 ohm input impedance • HDMI 1.4 (HDCP 1.4), 600 mV for each differential line, 100 ohm input impedance per differential pair
Synchronization input signals	Separate horizontal and vertical synchronizations, polarity-free TTL level, SOG (Composite SYNC on green)
AC input voltage/frequency/current	100 VAC to 240 VAC/50 Hz or 60 Hz \pm 3 Hz/1.5 A
Inrush current	30A (120V AC Input) 60A (240V AC Input)

Physical characteristics

Model	SE2419H/SE2419HX SE2719H/SE2719HX	
Signal cable type: Analog Digital	D-Sub (VGA), 15 pins; HDMI, 19 pins	
Dimensions (with stand):	SE2419H/SE2419HX	SE2719H/SE2719HX
Height	413.6 mm (16.28 in.)	454.2 mm (17.88 in.)
Width	539.4 mm (21.24 in.)	611.5 mm (24.07 in.)
Depth	152.8 mm (6.02 in.)	186.8 mm (7.35 in.)
Dimensions (without stand):	SE2419H/SE2419HX	SE2719H/SE2719HX
Height	323.1 mm (12.72 in.)	364.2 mm (14.34 in.)
Width	539.4 mm (21.24 in.)	611.5 mm (24.07 in.)
Depth	46.4 mm (1.83 in.)	46.4 mm (1.83 in.)

Stand dimensions:	SE2419H / SE2419HX	SE2719H / SE2719HX
Height	171.6 mm (6.76 in.)	176.7 mm (6.96 in.)
Width	249.0 mm (9.80 in.)	257.2 mm (10.13 in.)
Depth	152.8 mm (6.02 in.)	186.8 mm (7.35 in.)
Weight:	SE2419H/SE2419HX	SE2719H / SE2719HX
With packaging	5.59 kg (12.32 lb)	7.14 kg (15.74 lb)
With stand assembly and cables	3.91 kg (8.62 lb)	5.09 kg (11.22 lb)
Without stand assembly and cables	3.13 kg (6.90 lb)	4.24 kg (9.35 lb)
Weight of stand assembly	0.52 kg (1.15 lb)	0.59 kg (1.30 lb)

Environmental characteristics

Model	SE2419H/SE2419HX	SE2719H/SE2719HX
Temperature:		
Operating	0°C to 40°C (32°F to 104°F)	
Non-operating:		
Storage	• -20°C to 60°C (-4°F to 140°F)	
Shipping	• -20°C to 60°C (-4°F to 140°F)	
Humidity:		
Operating	10% to 80% (non-condensing)	
Non-operating:		
Storage	• 5% to 90% (non-condensing)	
Shipping	• 5% to 90% (non-condensing)	
Altitude:		
Operating (maximum)	5,000 m (16,400 ft)	
Non-operating (maximum)	12,192 m (40,000 ft)	
Thermal dissipation	75.1 BTU/hour (maximum) 58.0 BTU/hour (typical)	99.0 BTU/hour (maximum) 78.5 BTU/hour (typical)

Power management Modes

If you have VESA's DPM™ compliance display card or software installed in your PC, the monitor can automatically reduce its power consumption when not in use. This is referred to as *Power Save Mode**. If the computer detects input from the keyboard, mouse, or other input devices, the monitor automatically resumes functioning. The following table shows the power consumption and signaling of this automatic power saving feature.

SE2419H/SE2419HX

VESA modes	Horizontal sync	Vertical sync	Video	Power indicator	Power consumption
Normal operation	Active	Active	Active	White	22 W (maximum)** 17 W (typical)
Active-off mode	Inactive	Inactive	Blanked	White (Glowing)	Less than 0.5 W
Switch off	-	-	-	Off	Less than 0.3 W

Power Consumption P_{on}	17.1 W
Total Energy Consumption(TEC)	54.15 kWh

SE2719H/SE2719HX

VESA modes	Horizontal sync	Vertical sync	Video	Power indicator	Power consumption
Normal operation	Active	Active	Active	White	29 W (maximum)** 23 W (typical)
Active-off mode	Inactive	Inactive	Blanked	White (Glowing)	Less than 0.5 W
Switch off	-	-	-	Off	Less than 0.3 W

Power Consumption P_{on}	20.3 W
Total Energy Consumption(TEC)	64.05 kWh

* Zero power consumption in off mode can only be achieved by disconnecting the power cable from the monitor.

** Maximum power consumption with max luminance and contrast.

This document is informational only and reflects laboratory performance. Your product may perform differently, depending on the software, components and peripherals you ordered and shall have no obligation to update such information. Accordingly, the customer should not rely upon this information in making decisions about electrical tolerances or otherwise. No warranty as to accuracy or completeness is expressed or implied.

 **NOTE:**

P_{ON}: Power consumption of on Mode measured with reference to Energy Star test method.

TEC: Total energy consumption in kWh measured with reference to Energy Star test method.

The OSD functions only in the normal operation mode. When any button is pressed in the Active-off mode, one of the following messages will be displayed:

SE2419H

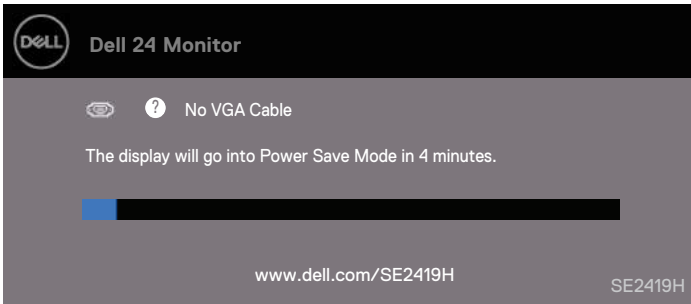

SE2419HX

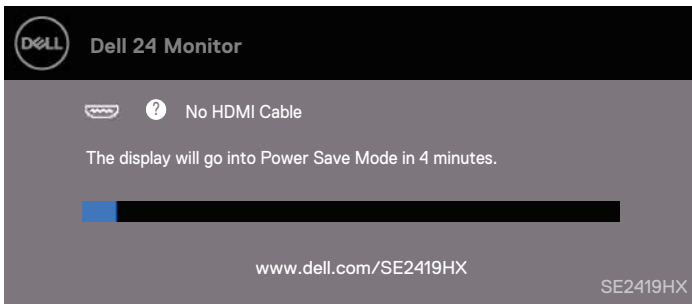

SE2719H

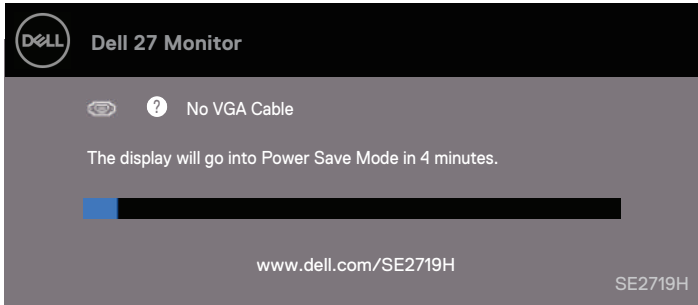

SE2719HX

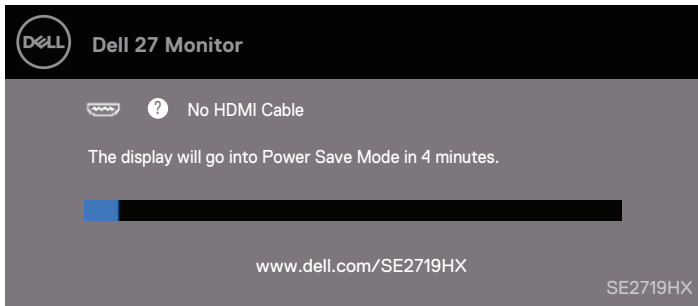

Activate the computer and the monitor to gain access to the OSD.

Plug and play capability



You can install the monitor in any Plug and Play-compatible system. The monitor automatically provides the computer system with its Extended Display Identification Data (EDID) using Display Data Channel (DDC) protocols so the system can configure itself and optimize the monitor settings. Most monitor installations are automatic, you can select different settings if desired. For more information about changing the monitor settings, see [Operating your monitor](#).

LCD monitor quality and pixel policy

During the LCD Monitor manufacturing process, it is normal for one or more pixels to become fixed in an unchanging state which are hard to see and do not affect the display quality or usability. For more information on Dell Monitor Quality and Pixel Policy, see Dell Support site at www.dell.com/support/monitors.

Maintenance guidelines

Cleaning your monitor

-  **WARNING:** Before cleaning the monitor, unplug the monitor power cable from the electrical outlet.
-  **CAUTION:** Read and follow the [Safety Instructions](#) before cleaning the monitor.

For best practices, follow the instructions in the list below while unpacking, cleaning or handling your monitor:

- To clean your screen, lightly dampen a soft, clean cloth with water. If possible, use a special screen-cleaning tissue or solution suitable for the anti-static coating. Do not use benzene, thinner, ammonia, abrasive cleaners or compressed air.
- Use a lightly-dampened cloth to clean the monitor. Avoid using detergent of any kind as some detergents leave a milky film on the monitor.
- If you notice white powder when you unpack your monitor, wipe it off with a cloth.
- Handle your monitor with care as the black-colored monitor may get scratched
- To help maintain the best image quality on your monitor, use a dynamically changing screen saver and turn off your monitor when not in use.

Setting up the monitor

Connecting the stand

- NOTE: The stand is not attached when the monitor is shipped from the factory.
- NOTE: The following procedure is applicable for the stand that shipped with your monitor.

To attach the monitor stand:

1. Connect the stand riser to the stand base, and then tighten the screw on the stand base.



2. Align the stand-riser bracket with the grooves at the back of the monitor.

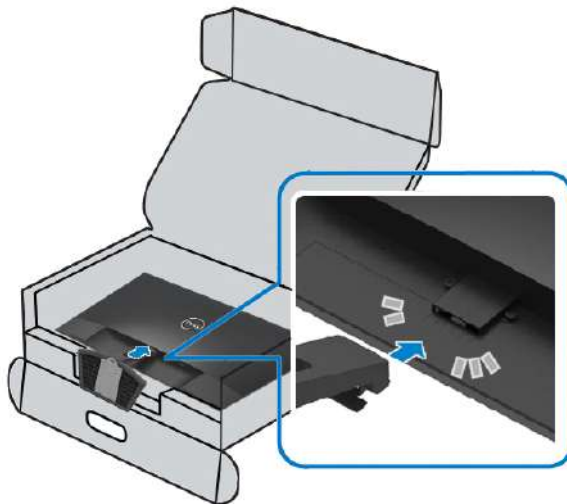

3. Slide the stand assembly until it snaps into place.

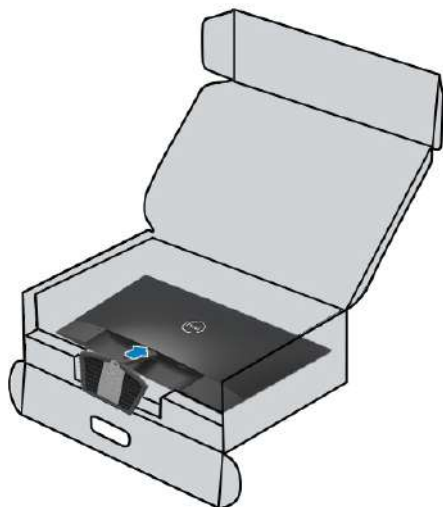

Connecting your monitor

⚠ WARNING: Before you begin any of the procedures in this section, follow the [Safety Instructions](#).

✍ NOTE: Do not connect all cables to the computer at the same time. It is recommended to route the cables through the cable-management slot before you connect them to the monitor.

To connect your monitor to the computer:

1. Turn off your computer and disconnect the power cable.
2. Connect VGA or HDMI cable from your monitor to the computer.

Connecting VGA cable



Connecting HDMI cable



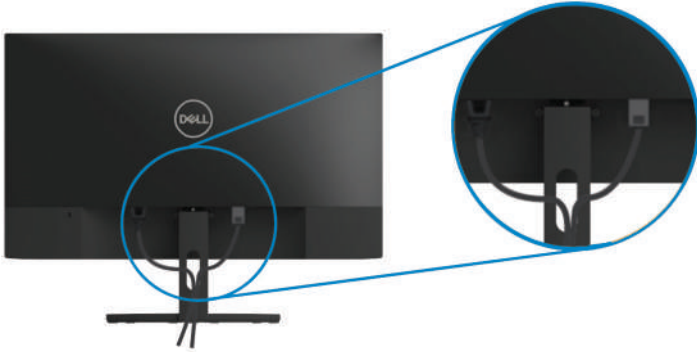

Organizing cables

Use the cable-management slot to route the cables connected to your monitor.



Removing the stand

-  **NOTE:** To prevent scratches on the screen when removing the stand, ensure that the monitor is placed on a soft and clean surface.
-  **NOTE:** The following procedure is applicable for the stand that shipped with your monitor.

To remove the stand:

1. Place the monitor on a soft cloth or cushion along the desk.



2. Tilt the stand downwards to access to the release button.



3. Using a long screwdriver press the release button.

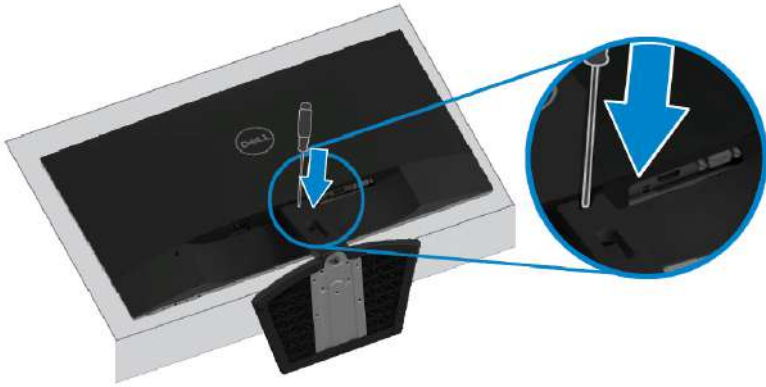

4. While keeping the release button pressed, pull the stand out.



Operating your monitor

Turning on the monitor

Press the  button to turn on the monitor.







Using the front panel controls

Use the control buttons at the bottom edge of the monitor to adjust the image being displayed.



The following table describes the control buttons:





Control Buttons	Description
1  Preset mode	Use this button to choose from a list of preset modes.

2		For direct access to the Brightness and Contrast menu.
	Brightness/Contrast	
3		To launch the On-Screen Display (OSD) menu, or to access the list of items / options of a menu item. For more information, see Accessing the OSD menu .
	Menu	
4		To exit or return to the OSD main menu.
	Exit	
5		To turn the monitor on or off.
	Power button (with power-status light)	Solid white light indicates the monitor is turned on and functioning normally. Blinking white light indicates the monitor is in power save mode.

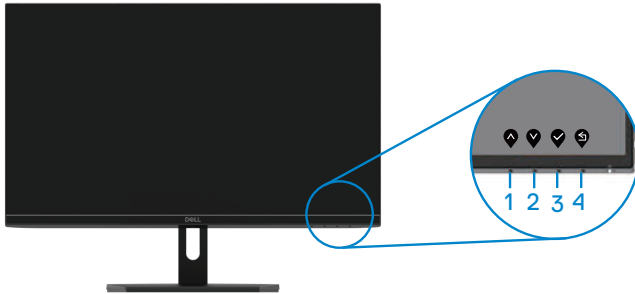
OSD controls

Use the buttons on the bottom edge of the monitor to adjust the image settings.



	Control Buttons	Description
1	 Up	Use the Up button to increase values or move up in a menu.
2	 Down	Use the Down button to decrease values or move down in a menu.
3	 OK	Use the OK button to confirm your selection in a menu.
4	 Back	Use the Back button to go back to the previous menu.

Using the On-Screen Display (OSD) menu







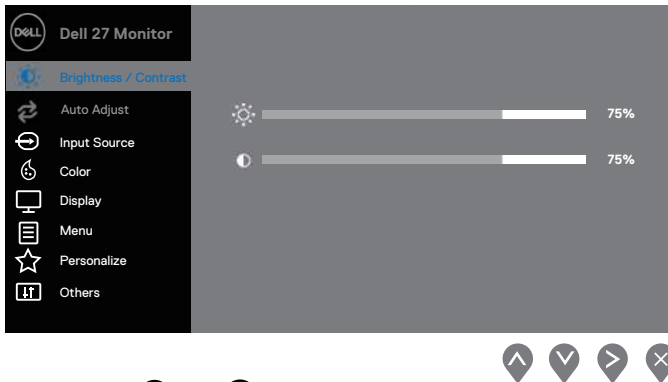
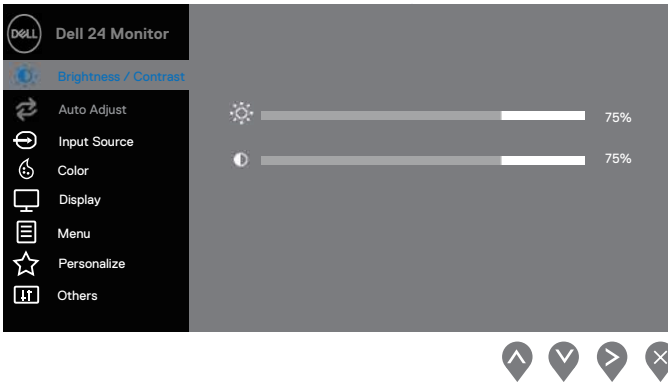

Accessing the OSD menu





 **NOTE:** Any changes you make are automatically saved when you move to another menu, exit the OSD menu, or wait for the OSD menu to close automatically.

1. Press the  button to display the OSD main menu.

Main menu for HDMI input

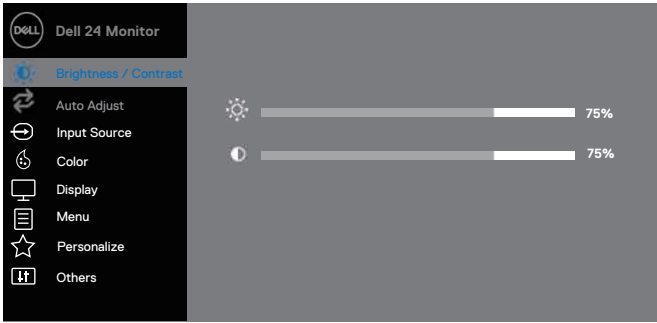
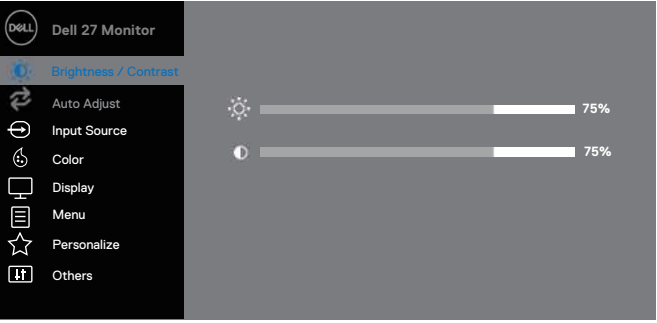

2. Press the  and  buttons to move between the setting options. As you move from one icon to another, the option name is highlighted.
3. Press the  button once to activate the highlighted option.
4. Press  and  button to select the desired parameter.
5. Press  and then use the  and  buttons, according to the indicators on the menu, to make your changes.
6. Select the  button to return to the main menu.

Icon	Menu and Submenus	Description
	Brightness/ Contrast	<p>Use this option to control the brightness or contrast settings.</p>  
	Brightness	<p>Brightness adjusts the luminance of the backlight.</p> <p>Press the  button to increase the brightness and press the  button to decrease the brightness (min. 0; max. 100).</p> <p>NOTE: Manual adjustment of brightness is disabled when dynamic contrast is switched on.</p>
	Contrast	<p>Adjust the brightness first, and then adjust the contrast only if further adjustment is necessary.</p> <p>Press the  button to increase the contrast and press the  button to decrease the contrast (min. 0; max. 100).</p> <p>The contrast function adjusts the degree of difference between darkness and lightness on the screen.</p>



Auto Adjust

Use this option to activate automatic setup and adjust menu.

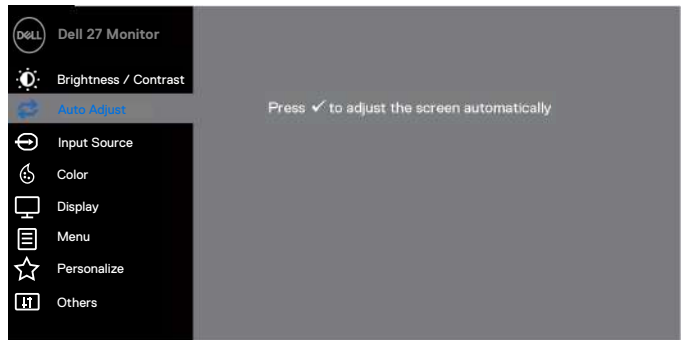
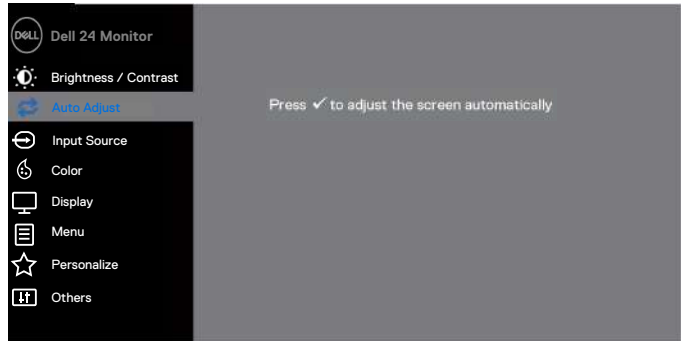

The following dialog appears on a black screen as the monitor self-adjusts to the current input:



Auto Adjust allows the monitor to self-adjust to the incoming video signal. After using Auto Adjustment, you can further tune your monitor by using the Pixel Clock (Coarse) and Phase (Fine) controls under Display.

NOTE: Auto Adjust does not occur if you press the button while there are no active video input signals or attached cables. This option is only available when you are using the analog (VGA) connector.



Input Source

Use the input source menu to switch between the different video signals that may be connected to your monitor.

SE2419H/SE2419HX: one VGA and one HDMI input

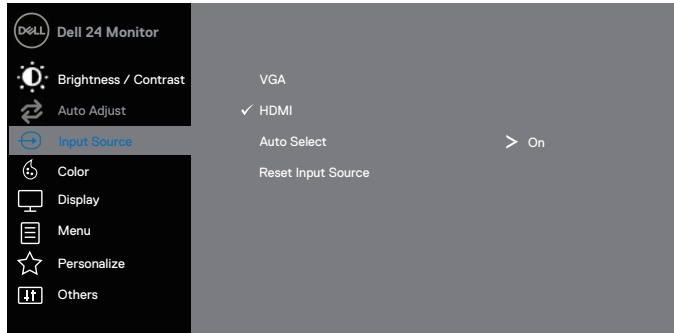

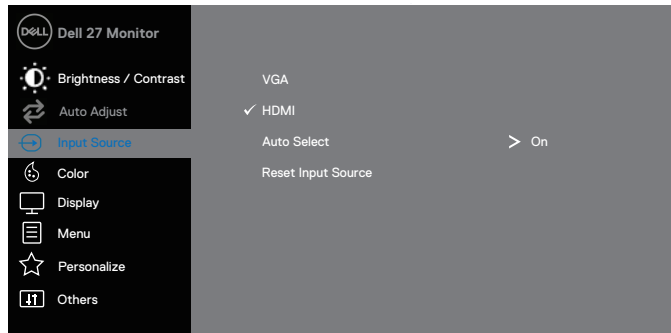

SE2719H/SE2719HX: one VGA and one HDMI input





VGA

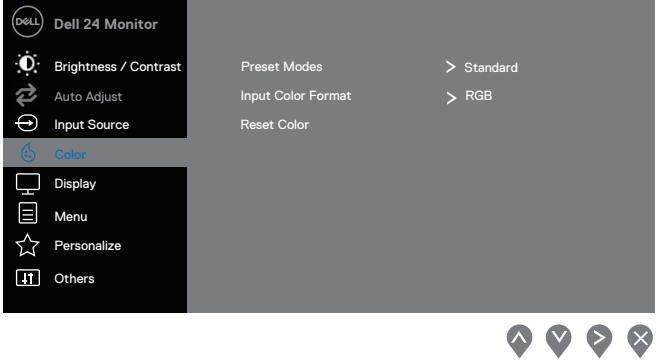
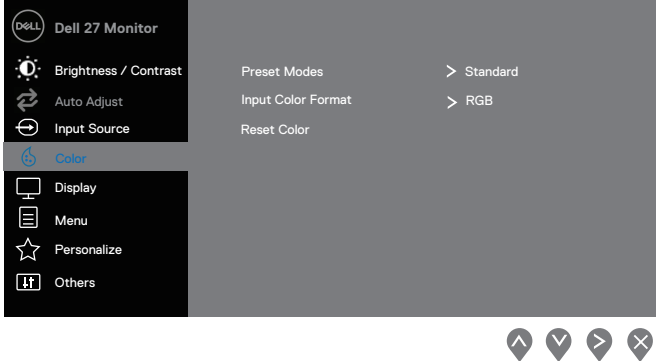



Push  to select the VGA input source when using VGA connector.



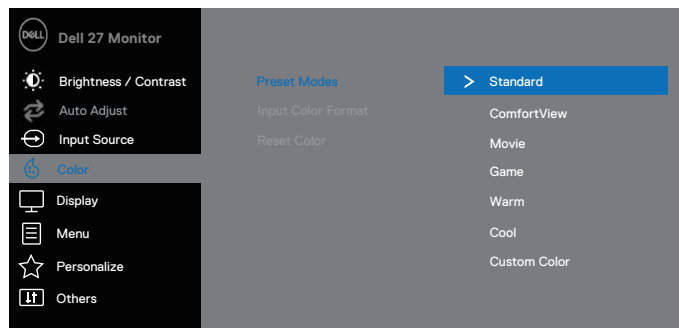
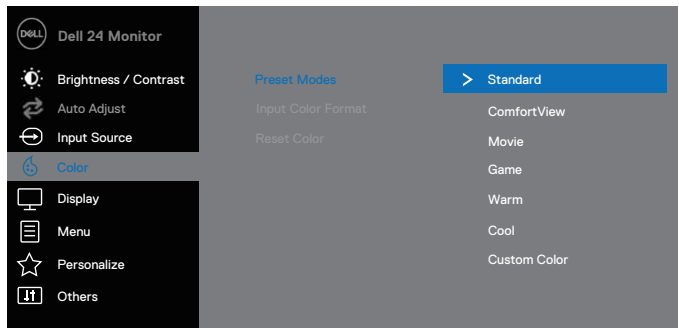

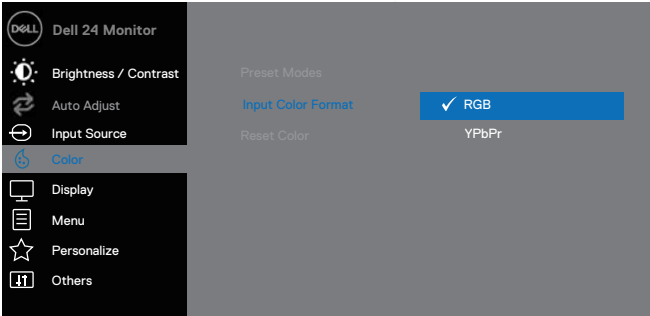
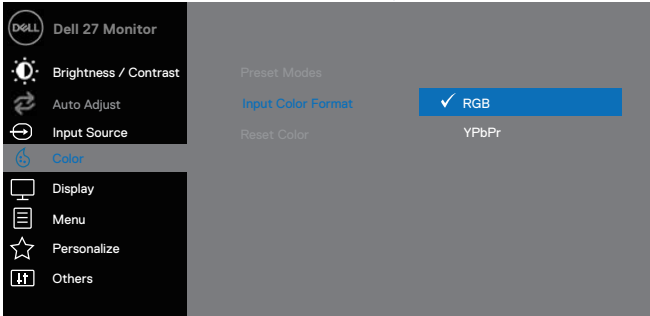



	<p>HDMI</p>	<p>Push  to select the HDMI input source when using HDMI connector.</p>
	<p>Auto Select</p>	<p>Select Auto Select to scan for available input signals.</p>
	<p>Reset Input Source</p>	<p>Select this option to restore default input source.</p>
	<p>Color</p>	<p>Use color to adjust the color setting mode.</p>  
	<p>Preset Modes</p>	<p>When you select Preset Modes, you can choose Standard, ComfortView, Movie, Game, Warm, Cool or Custom Color from the list.</p> <ul style="list-style-type: none"> • Standard: Loads the monitor's default color settings. This is the default preset mode. • ComfortView: Decreases the level of blue light emitted from the screen to make viewing more comfortable for your eyes. NOTE: To reduce the risk of eye strain and neck/arm/back/shoulders pain from using the monitor for long periods of time, we suggest that you:





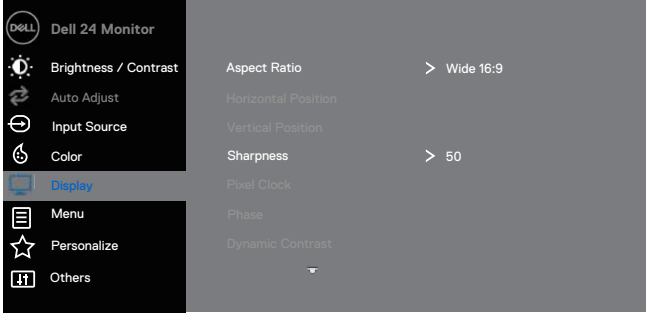

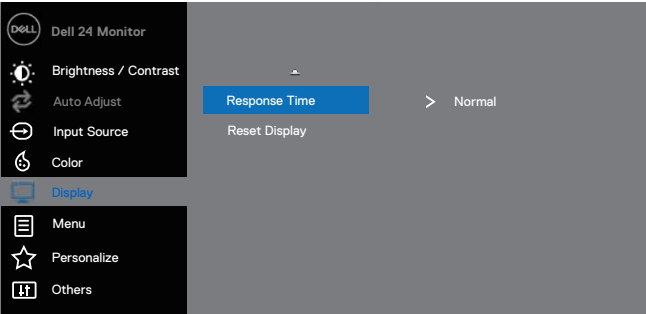

- Set the screen about 20~28 inches (50~70 cm) from your eyes.
 - Blink frequently to moisten or lubricate your eyes.
 - Take regular 20-minute breaks every two hours.
 - Look away from your monitor and gaze at a distant object at 20 feet away for at least 20 seconds during the breaks.
 - Perform stretches to relieve tension in the neck/arm/back/shoulders during the breaks.
- **Movie:** Loads color settings ideal for movies.
 - **Game:** Loads color settings ideal for most gaming applications.
 - **Warm:** Increases the color temperature. The screen appears warmer with a red/yellow tint.
 - **Cool:** Decreases the color temperature. The screen appears cooler with a blue tint.
 - **Custom Color:** Allows you to manually adjust the color settings.

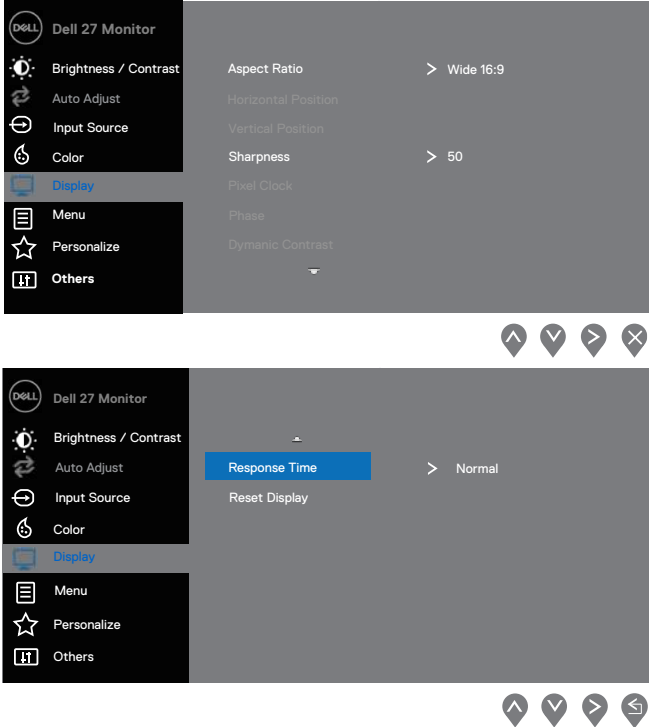







Press the  and  buttons to adjust the three colors (R, G, B) values and create your own preset color mode.



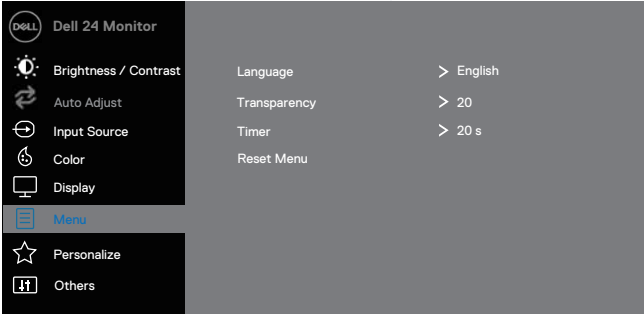

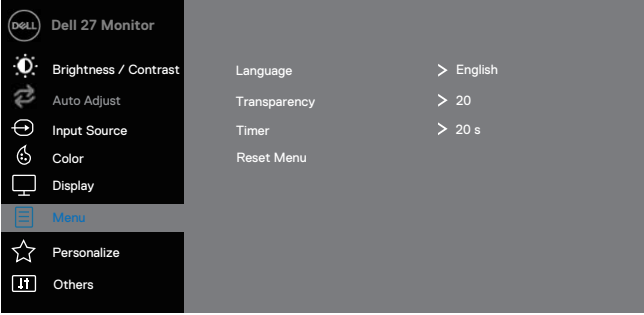



<p>Input Color Format</p>	<p>Allow you to set the video input mode to:</p> <ul style="list-style-type: none"> • RGB: Select this option if your monitor is connected to a computer or DVD player using the HDMI cable. • YPbPr: Select this option if your DVD player supports only YPbPr output.  
<p>Hue</p>	<p>This feature can shift the color of the video image to green or purple. This is used to adjust the desired skin tone color. Use  or  to adjust the hue from 0 to 100.</p> <p>Press  to increase the green shade of the video image.</p> <p>Press  to decrease the purple shade of the video image.</p> <p>NOTE: Hue adjustment is available only when you select Movie or Game preset mode.</p>

	Saturation	<p>This feature can adjust the color saturation of the video image. Use  or  to adjust the saturation from 0 to 100.</p> <p>Press  to increase the monochrome appearance of the video image.</p> <p>Press  to decrease the colorful appearance of the video image.</p> <p>NOTE: Saturation adjustment is available only when you select Movie or Game preset mode.</p>
	Reset Color	Reset your monitor color settings to the factory settings.
	Display	<p>Use the display to adjust image.</p>    

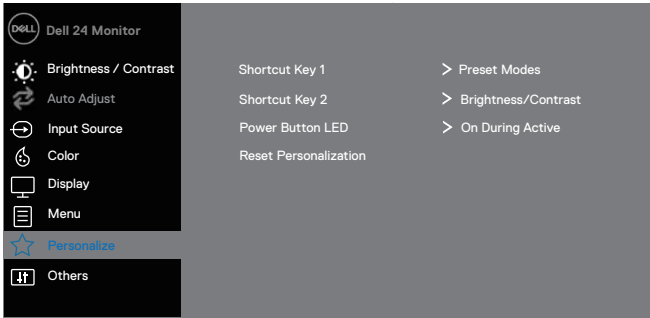
	
Aspect Ratio	Adjust the image ratio to Wide 16:9, 4:3 or 5:4.
Horizontal Position (VGA input only)	Use  or  to move image left and right. Minimum is '0' (-). Maximum is '100' (+).
Vertical Position (VGA input only)	Use the  or  to move image up and down. Minimum is '0' (-). Maximum is '100' (+).
Sharpness	This feature can make the image look sharper or softer. Use  or  to adjust the sharpness from 0 to 100.
Pixel Clock (VGA input only)	The Pixel Clock feature enables you to adjust image quality on your monitor to your preference. Use  or  buttons to adjust for best image quality.
Phase (VGA input only)	If satisfactory results are not obtained using the Phase adjustment, use the Pixel Clock (coarse) adjustment and then use Phase (fine), again.

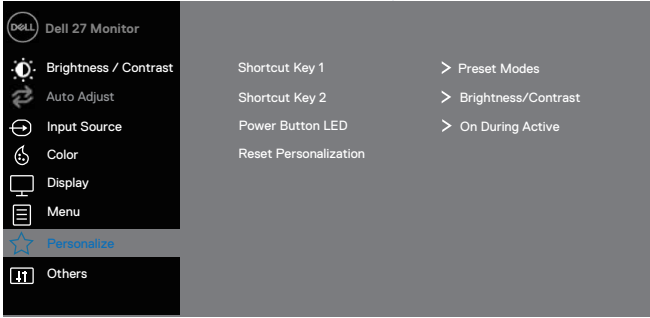
	<p>Dynamic Contrast</p>	<p>Allow you to increase the level of contrast to provide sharper and more detailed image quality.</p> <p>Press the  button to select the dynamic contrast On or Off. NOTE: Dynamic contrast provides higher contrast if you select movie or game preset mode.</p>
	<p>Response Time</p>	<p>Allow you to select between Normal (8 ms), Fast(5 ms).</p>
	<p>Reset Display</p>	<p>Select this option to restore default display settings.</p>
	<p>Menu</p>	<p>Select this option to adjust the settings of the OSD, such as the languages of the OSD, the amount of time, the menu remains on screen and so on.</p> <div data-bbox="359 443 1003 759">  <p>Dell 24 Monitor</p> <ul style="list-style-type: none"> Brightness / Contrast Auto Adjust Input Source Color Display Menu Personalize Others <p>Language > English</p> <p>Transparency > 20</p> <p>Timer > 20 s</p> <p>Reset Menu</p> </div> <div data-bbox="852 772 1003 807">  </div> <div data-bbox="359 823 1003 1139">  <p>Dell 27 Monitor</p> <ul style="list-style-type: none"> Brightness / Contrast Auto Adjust Input Source Color Display Menu Personalize Others <p>Language > English</p> <p>Transparency > 20</p> <p>Timer > 20 s</p> <p>Reset Menu</p> </div> <div data-bbox="852 1152 1003 1187">  </div>
	<p>Language</p>	<p>Language options set the OSD display to one of the eight languages (English, Spanish, French, German, Brazilian Portuguese, Russian, Simplified Chinese, or Japanese).</p>
	<p>Transparency</p>	<p>Select this option to change the menu transparency by pressing the  or  buttons from 0 to 100.</p>

	Timer	OSD hold time: sets the length of time, the OSD will remain active after the last time you pressed a button. Use  or  to adjust the slider in 1 second increments, from 5 to 60 seconds.
	Reset Menu	Reset all OSD settings to the factory preset values.
	Personalize	<p>Allow you to choose a feature from Shortcut key 1, Shortcut key 2, Power Button LED or Reset Personalization, Preset Modes or Brightness/Contrast and set it as a shortcut key.</p>    
	Shortcut Key 1	Allow you to select one of the following: Preset Modes, Brightness/Contrast, Auto Adjust, Input Source, Aspect Ratio, to set the shortcut key 1.
	Shortcut Key 2	Allow you to select one of the following: Preset Modes, Brightness/Contrast, Auto Adjust, Input Source, Aspect Ratio, to set the shortcut key 2.
	Power Button LED	Allow you to set the power LED indicator On During Active or Off During Active to save energy.
	Reset Personalization	Allow you to restore shortcut key to the default setting.



Others

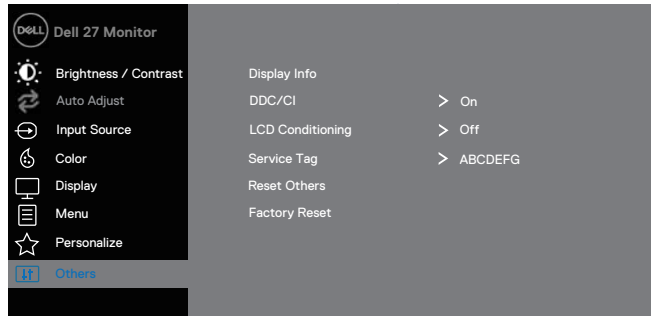
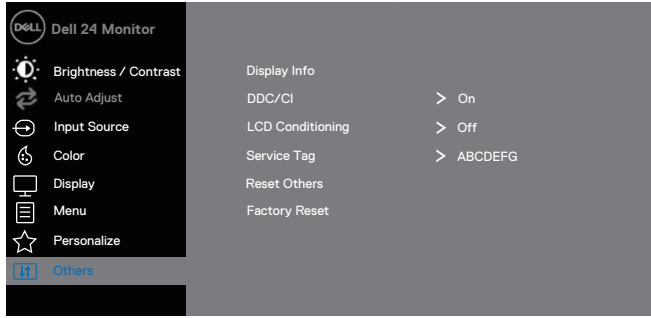

Display Info

Press to display the information about the display.

SE2419H:

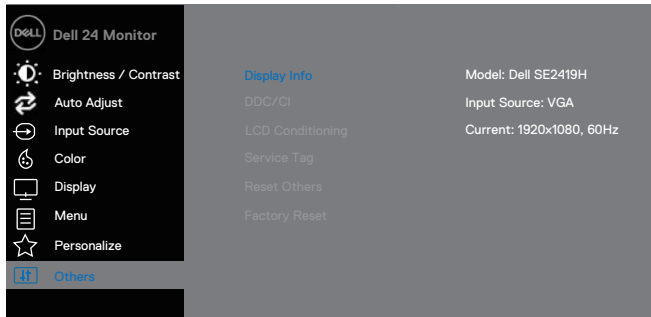

SE2419HX:

Dell 24 Monitor

- Brightness / Contrast
- Auto Adjust
- Input Source
- Color
- Display
- Menu
- Personalize
- Others

Display Info

- DDC/CI
- LCD Conditioning
- Service Tag
- Reset Others
- Factory Reset

Model: Dell SE2419HX

- Input Source: HDMI
- Current: 1920x1080, 60Hz



SE2719H:

Dell 27 Monitor

- Brightness / Contrast
- Auto Adjust
- Input Source
- Color
- Display
- Menu
- Personalize
- Others

Display Info

- DDC/CI
- LCD Conditioning
- Service Tag
- Reset Others
- Factory Reset

Model: Dell SE2719H

- Input Source: VGA
- Current: 1920x1080, 60Hz



SE2719HX:

Dell 27 Monitor

- Brightness / Contrast
- Auto Adjust
- Input Source
- Color
- Display
- Menu
- Personalize
- Others

Display Info

- DDC/CI
- LCD Conditioning
- Service Tag
- Reset Others
- Factory Reset

Model: Dell SE2719HX

- Input Source: HDMI
- Current: 1920x1080, 60Hz



DDC/CI

DDC/CI (Display Data Channel/Command Interface) allows you to adjust the monitor settings using software on your computer. Select Off to turn off this feature. Enable this feature for best user experience and optimum performance of your monitor.

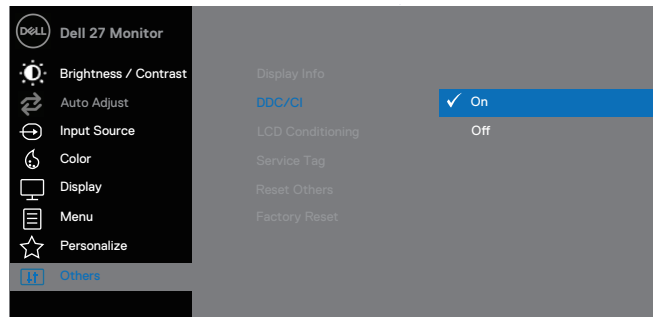
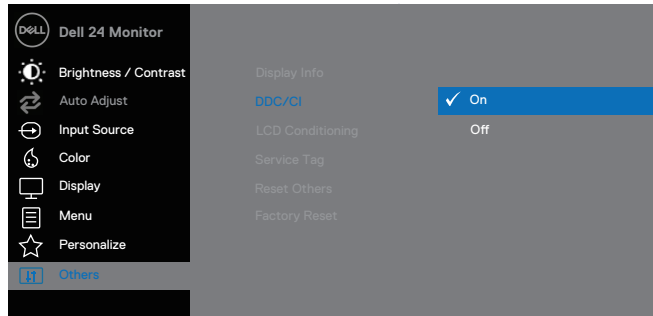

LCD Conditioning

Help reduce minor cases of image retention. Depending on the degree of image retention, the program may take some time to run. To start **LCD Conditioning**, select On.

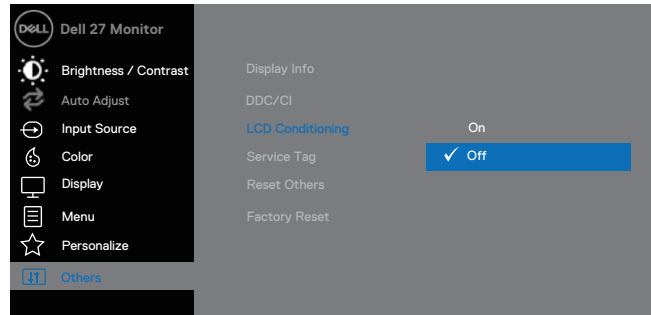
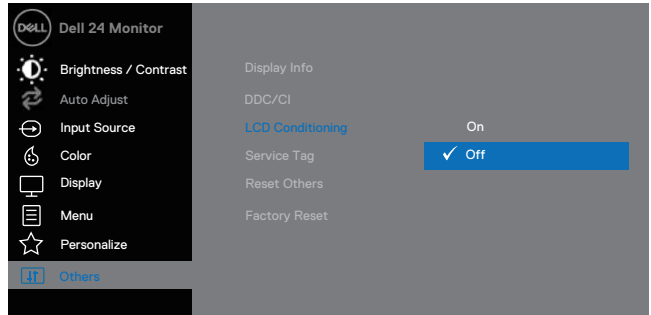

Service Tag

Display the Service Tag number of the monitor.

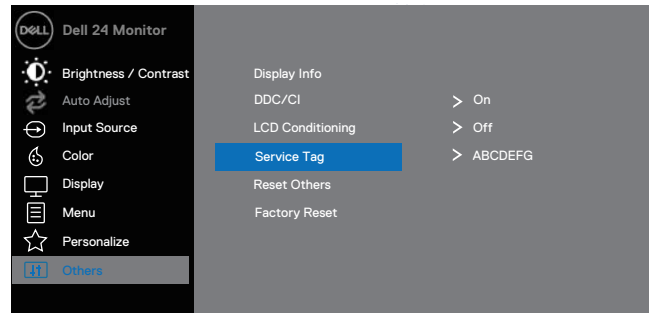

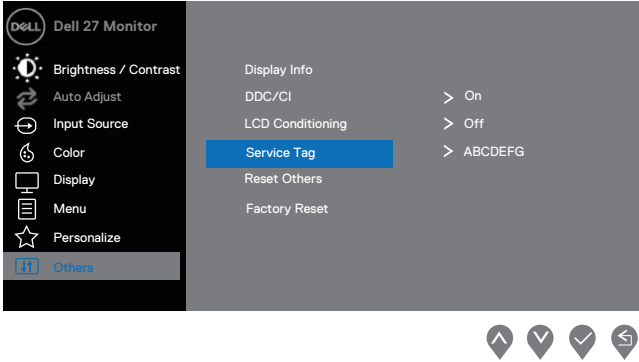
		
	Reset Other	Reset all settings under the Others setting menu to the factory default.
	Factory Reset	Reset all settings to the factory default.

 **NOTE: Your monitor has a built-in feature to automatically calibrate the brightness to compensate for LED aging.**

OSD warning messages

When the Dynamic Contrast feature is enabled (in **Movie** or **Game** preset modes), the manual brightness adjustment is disabled.

SE2419H

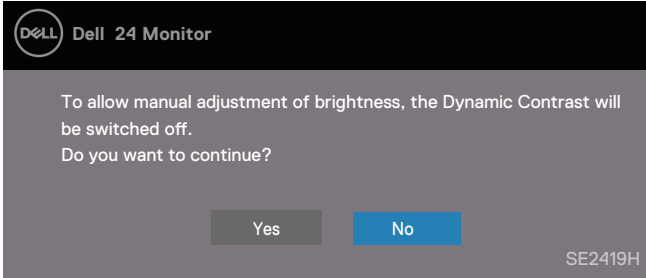

SE2419HX

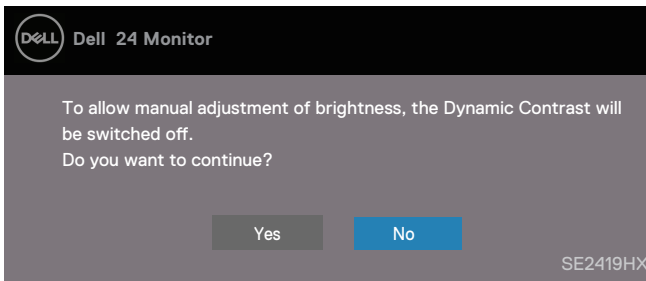

SE2719H

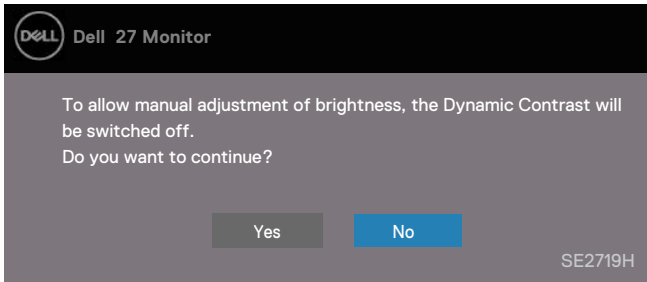

SE2719HX

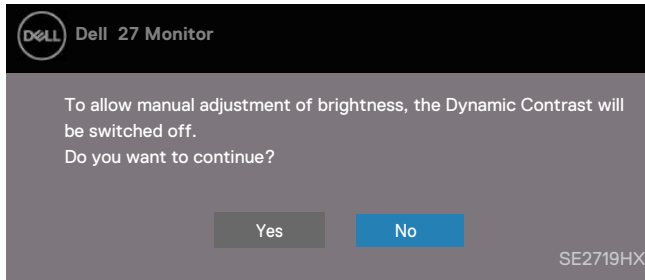

Before the DDC/CI function is disabled, the following message is displayed.

SE2419H

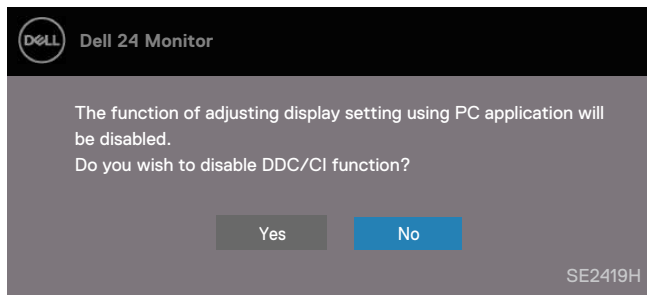

SE2419HX

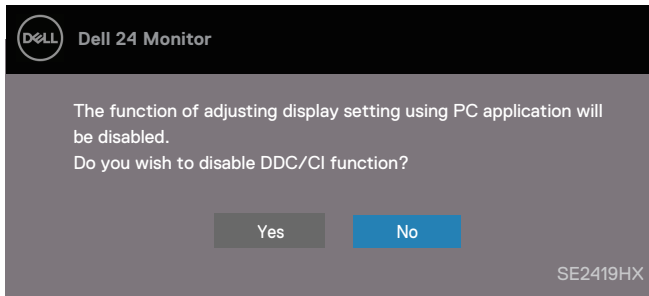

SE2719H

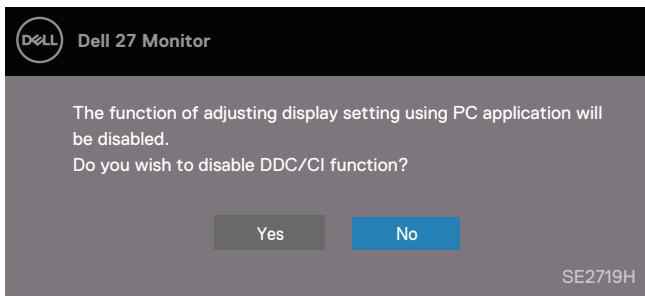

SE2719HX

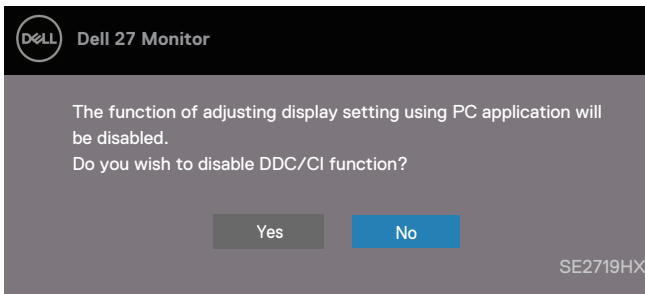

When the monitor enters Power Save Mode, the following message appears.

SE2419H

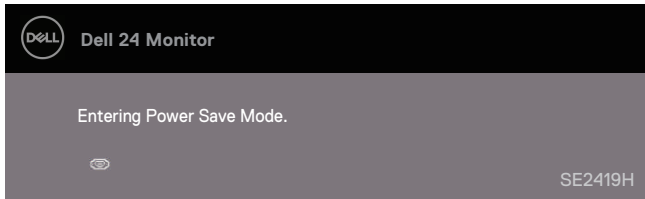

SE2419HX

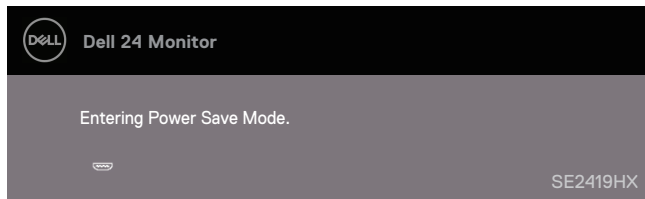

SE2719H

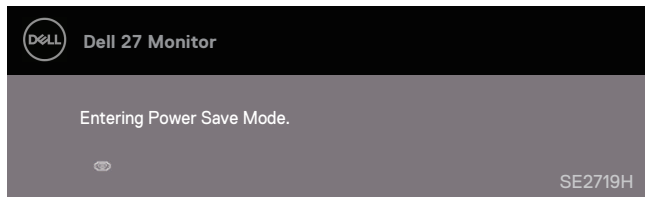

SE2719HX

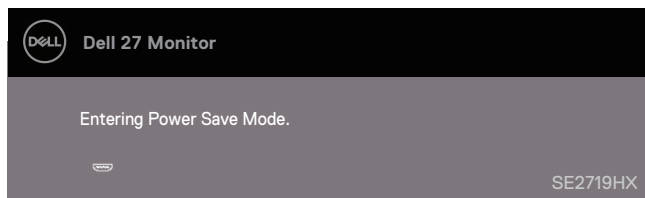

If VGA or HDMI cable is not connected, a floating dialog box as shown below appears. The monitor will enter Power Save Mode after 4 minutes if left at this state.

SE2419H

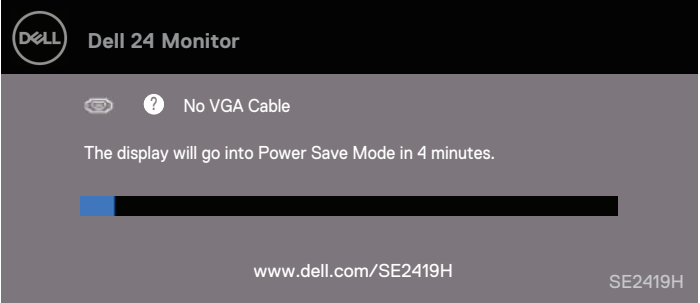

SE2419HX

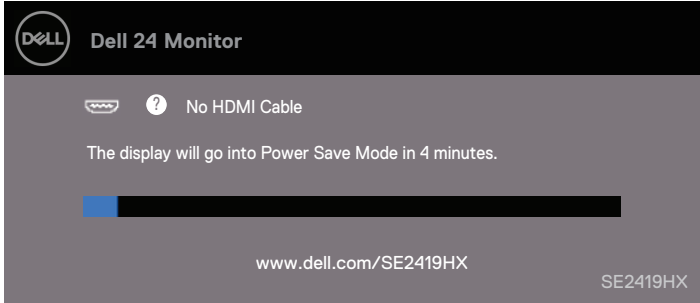

SE2719H

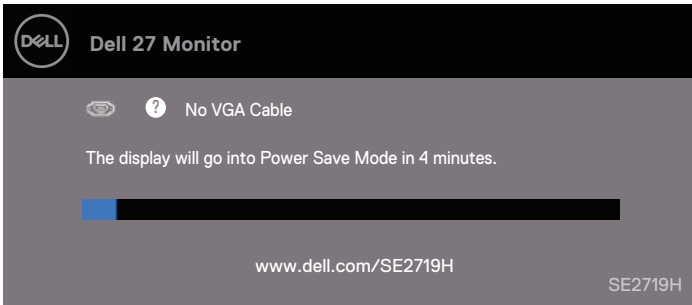

SE2719HX

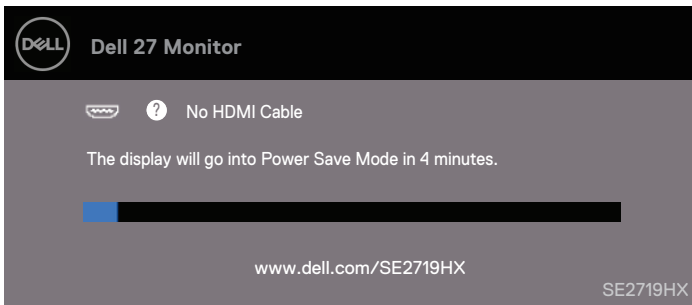

See [Troubleshooting](#) for more information.

Setting up your monitor

Setting display resolution to 1920 x 1080

For best performance, set the display resolution to 1920 x 1080 pixels by performing the following steps:

In Windows 7:

1. Right-click on the desktop and click **Screen Resolution**.
2. Click the drop-down menu of the **Screen Resolution** and select 1920 x 1080.
3. Click **OK**.

In Windows 8 or Windows 8.1:

1. Select the Desktop tile to switch to classic desktop.
2. Right-click on the desktop and click **Screen Resolution**.
3. Click the drop-down menu of the **Screen Resolution** and select 1920 x 1080.
4. Click **OK**.

In Windows 10:

1. Right-click on the desktop and click **Display Settings**.
2. Click **Advanced Display Settings**.
3. Click the drop-down menu under **Resolution** and select 1920 x 1080
4. Click **Apply**.

If you do not see the recommended resolution as an option, you may need to update your graphics driver. Use one of the following methods to update the graphics driver:

Dell computer

1. Go to www.dell.com/support, enter your service tag, and download the latest driver for your graphics card.
2. After installing the drivers for your graphics adapter, attempt to set the resolution to 1920 x 1080 again.

 **NOTE: If you are unable to set the resolution to 1920 x 1080 please contact Dell to inquire about a graphics adapter that supports these resolutions.**

Non-Dell computer

In Windows 7:

1. Right-click on the desktop and click **Personalization**.
2. Click **Change Display Settings**.
3. Click **Advanced Settings**.
4. Identify your graphics controller supplier from the description at the top of the window (e.g. NVIDIA, AMD, Intel etc.).
5. Refer to the graphic card provider website for updated driver (for example, www.AMD.com or www.NVIDIA.com).
6. After installing the drivers for your graphics adapter, attempt to set the resolution to 1920 x 1080 again.

In Windows 8 or Windows 8.1:

1. Select the Desktop tile to switch to classic desktop.
2. Right-click on the desktop and click **Personalization**.
3. Click **Change Display Settings**.
4. Click **Advanced Settings**.
5. Identify your graphics controller supplier from the description at the top of the window (e.g. NVIDIA, AMD, Intel etc.).
6. Refer to the graphic card provider website for updated driver (for example, www.AMD.com or www.NVIDIA.com).
7. After installing the drivers for your graphics adapter, attempt to set the resolution to 1920 x 1080 again.

In Windows 10:

1. Right-click on the desktop and click **Display Settings**.
2. Click **Advanced display settings**.
3. Click **Display adapter properties**.
4. Identify your graphics controller supplier from the description at the top of the window (e.g. NVIDIA, AMD, Intel etc.).
5. Refer to the graphic card provider website for updated driver (for example, www.AMD.com or www.NVIDIA.com).
6. After installing the drivers for your graphics adapter, attempt to set the resolution to 1920 x 1080 again.

 **NOTE: If you are unable to set the recommended resolution, please contact the manufacturer of your computer or consider purchasing a graphics adapter that supports the video resolution.**

Using tilt

You can tilt the monitor for the most comfortable viewing angle.

 **NOTE:** The stand is not attached when the monitor is shipped from the factory.



Troubleshooting

⚠ WARNING: Before you begin any of the procedures in this section, follow the [Safety Instructions](#).

Self-test

Your monitor provides a self-test feature that allows you to check if your monitor is functioning properly. If your monitor and computer are properly connected but the monitor screen remains dark, run the monitor self-test by performing the following steps:

1. Turn on both your computer and the monitor.
2. Disconnect all video cables from the monitor. This way, the computer doesn't have to be involved.
3. Turn on the monitor.

If the monitor is working correctly, it detects that there is no signal and one of the following message appears. While in self-test mode, the power LED remains white.

SE2419H

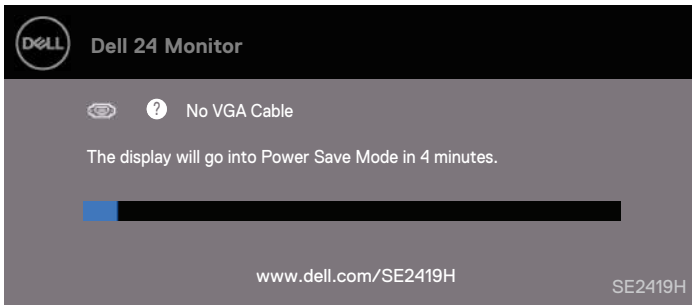

SE2419HX

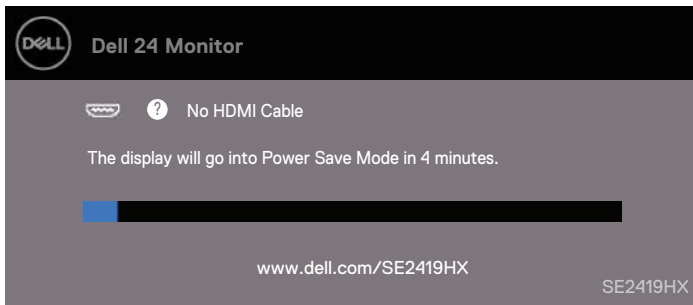

SE2719H

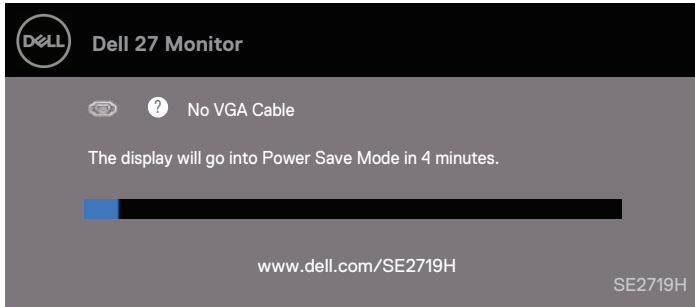

SE2719HX

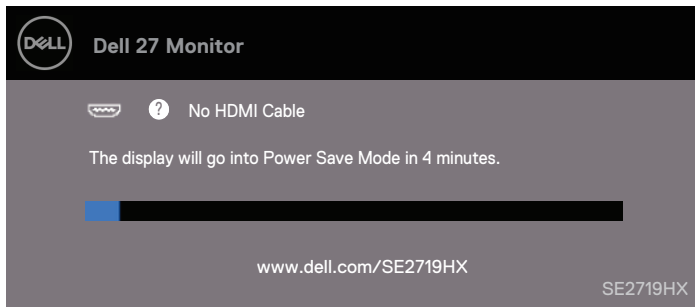

 **NOTE: This box also appears during normal operation, when the video cable is disconnected or damaged.**

4. Turn off your monitor and reconnect the video cable; then turn on your computer and the monitor.

If your monitor remains dark after you reconnect the cables, check your video controller and computer.

Built-in diagnostics

Your monitor has a built-in diagnostic tool that helps you determine if any screen abnormality you experience is an inherent problem with your monitor, or with your computer and video card.

 **NOTE: You can run the built-in diagnostics only when the video cable is unplugged and the monitor is in self-test mode.**

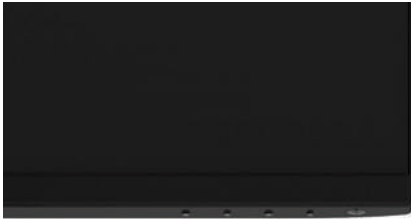

1

Label	Description
1	Button 1

To run the built-in diagnostics:

1. Ensure that the screen is clean (no dust particles on the surface of the screen).
2. Unplug the video cable(s) from the back of the computer or monitor. The monitor then goes into the self-test mode.
3. Press and hold Button 1 for 5 seconds. A gray screen appears.
4. Carefully inspect the screen for abnormalities.
5. Press Button 1 on the bottom of the monitor again. The color of the screen changes to red.
6. Inspect the display for any abnormalities.
7. Repeat steps 5 and 6 to inspect the display in green, blue, black, white and text screens.

Common problems

The following table contains general information about common monitor problems you might encounter and the possible solutions:

Common Symptoms	Possible Solutions
No Video/Power LED off	<ul style="list-style-type: none">• Ensure that the video cable connecting the monitor and the computer is properly connected and secure.• Verify that the power outlet is functioning properly using any other electrical equipment.• Ensure that the power button is pressed.• Ensure that the correct input source is selected via the Input Source menu.
No Video/Power LED on	<ul style="list-style-type: none">• Increase brightness and contrast controls using the OSD.• Perform monitor self-test feature check.• Check for bent or broken pins in the video cable connector.• Run the built-in diagnostics.• Ensure that the correct input source is selected via the Input Source menu.
Poor focus	<ul style="list-style-type: none">• Eliminate video extension cables.• Reset the monitor to Factory Settings (Factory Reset).• Change the video resolution to the correct aspect ratio.
Shaky/Jittery video	<ul style="list-style-type: none">• Reset the monitor to Factory Settings (Factory Reset).• Check environmental factors.• Relocate the monitor and test in another room.
Missing pixels	<ul style="list-style-type: none">• Cycle power On-off.• Pixel that is permanently off is a natural defect that can occur in LCD technology.• For more information on Dell Monitor Quality and Pixel Policy, see Dell Support site at: www.dell.com/support/monitors.
Stuck-on pixels	<ul style="list-style-type: none">• Cycle power On-off.• Pixel that is permanently off is a natural defect that can occur in LCD technology. <p>For more information on Dell Monitor Quality and Pixel Policy, see Dell Support site at: www.dell.com/support/monitors.</p>
Brightness problems	<ul style="list-style-type: none">• Reset the monitor to Factory Settings (Factory Reset).• Adjust brightness & contrast controls via OSD.
Geometric distortion	<ul style="list-style-type: none">• Reset the monitor to Factory Settings (Factory Reset).• Adjust horizontal & vertical controls via OSD.
Horizontal/Vertical lines	<ul style="list-style-type: none">• Reset the monitor to Factory Settings (Factory Reset).• Perform monitor self-test feature check and determine if these lines are also in self-test mode.• Check for bent or broken pins in the video cable connector.• Run the built-in diagnostics.

Synchronization problems	<ul style="list-style-type: none"> • Reset the monitor to factory settings (Factory Reset). • Perform monitor self-test feature check to determine if the scrambled screen appears in self-test mode. • Check for bent or broken pins in the video cable connector. • Restart the computer in safe mode.
Safety related issues	<ul style="list-style-type: none"> • Do not perform any troubleshooting step. • Contact Dell immediately.
Intermittent problems	<ul style="list-style-type: none"> • Ensure that the video cable connecting the monitor to the computer is connected properly and is secure. • Reset the monitor to Factory Settings (Factory Reset). • Perform monitor self-test feature check to determine if the intermittent problem occurs in self-test mode.
Missing color	<ul style="list-style-type: none"> • Perform monitor self-test feature check. • Ensure that the video cable connecting the monitor to the computer is connected properly and is secure. • Check for bent or broken pins in the video cable connector.
Wrong color	<ul style="list-style-type: none"> • Change the Color Setting Mode in the Color Settings OSD to Graphics or Video depending on the application. • Try different Preset Modes in Color settings OSD. Adjust R/G/B value in Custom Color in Color settings OSD. • Change the Input Color Format to RGB or YPbPr in the Color settings OSD. • Run the built-in diagnostics.
Image retention from a static image left on the monitor for a long period of time	<ul style="list-style-type: none"> • Use the Power Management feature to turn off the monitor at all times when not in use (for more information, see Power management modes). • Alternatively, use a dynamically changing screensaver.
Video ghosting or overshooting	<ul style="list-style-type: none"> • Change the Response Time in the Display OSD to Fast or Normal depending on your application and usage.

Product-specific problems

Specific Symptoms	Possible Solutions
Screen image is too small	<ul style="list-style-type: none">• Check the Aspect Ratio setting in the Display settings OSD.• Reset the monitor to Factory Settings (Factory Reset).
Cannot adjust the monitor with the buttons on the bottom of the panel	<ul style="list-style-type: none">• Turn off the monitor, unplug the power cord, plug it back, and then turn on the monitor.
No input signal when user controls are pressed	<ul style="list-style-type: none">• Check the signal source. Ensure the computer is not in standby or sleep mode by moving the mouse or pressing any key on the keyboard.• Check if the video cable is plugged in properly. Disconnect and reconnect the video cable if necessary.• Reset the computer or video player.
The picture does not fill the entire screen	<ul style="list-style-type: none">• Due to different video formats (aspect ratio) of DVDs, the monitor may display in full screen.• Run the built-in diagnostics.

Appendix

Safety instructions

⚠ WARNING: Use of controls, adjustments, or procedures other than those specified in this documentation may result in exposure to shock, electrical hazards, and/or mechanical hazards.

For information on safety instructions, see the Product Information Guide.

FCC Notices (U.S. Only) and Other Regulatory Information

For FCC notices and other regulatory information, see the regulatory compliance website located at www.dell.com/regulatory_compliance.

Contacting Dell

For customers in the United States, call 800-WWW-DELL (800-999-3355).

✍ NOTE: If you do not have an active Internet connection, you can find contact information on your purchase invoice, packing slip, bill, or Dell product catalog.

Dell provides several online and telephone-based support and service options. Availability varies by country and product, and some services may not be available in your area.

To get online Monitor support content:

1. Visit www.dell.com/support/monitors.

To contact Dell for sales, technical support, or customer service issues:

1. Visit www.dell.com/support.
2. Verify your country or region in the Choose A Country/Region drop-down menu at the bottom of the page.
3. Click Contact Us on the left side of the page.
4. Select the appropriate service or support link based on your need.
5. Choose the method of contacting Dell that is convenient for you.

⚠ WARNING: For displays with glossy bezels the user should consider the placement of the display as the bezel may cause disturbing reflections from surrounding light and bright surfaces.

Pin assignments

D-Sub 15-pin connector

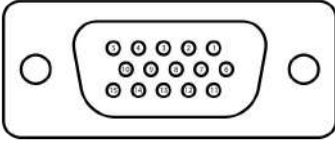

Pin Number	Signal Assignment
1	Video-Red
2	Video-Green
3	Video-Blue
4	GND
5	Self-test
6	GND-R
7	GND-G
8	GND-B
9	DDC +5 V
10	GND-sync
11	GND
12	DDC data
13	H-sync
14	V-sync
15	DDC clock

Pin assignments

HDMI 19-pin connector

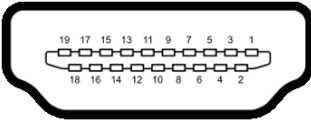

Pin Number	Signal Assignment
1	TMDS DATA 2+
2	TMDS DATA 2 SHIELD
3	TMDS DATA 2-
4	TMDS DATA 1+
5	TMDS DATA 1 SHIELD
6	TMDS DATA 1-
7	TMDS DATA 0+
8	TMDS DATA 0 SHIELD
9	TMDS DATA 0-
10	TMDS CLOCK+
11	TMDS CLOCK SHIELD
12	TMDS CLOCK-
13	CEC
14	Reserved (N.C. on device)
15	DDC CLOCK (SCL)
16	DDC DATA (SDA)
17	DDC/CEC Ground
18	+5V POWER
19	HOT PLUG DETECT