

**ANOVA**

**PRECISION<sup>®</sup> OVEN**

**USER GUIDE**

## SAFETY STANDARDS

---

When using electrical appliances, basic safety precautions should always be followed, including the following:

1. Read all instructions.
2. Do not touch hot surfaces. Use handles or knobs.
3. To protect against electric shock, do not place cord, plugs, or appliance in water or other liquid.
4. Close supervision is necessary when any appliance is used by or near children.
5. Unplug from outlet when not in use and before cleaning. Allow to cool before putting on or taking off parts.
6. Do not operate any appliance with a damaged cord or plug. If the appliance malfunctions, or has been damaged in any manner, contact Anova immediately. [www.support.anovaculinary.com](http://www.support.anovaculinary.com)
7. Do not use outdoors.
8. Do not let cord touch hot surfaces or hang over edge of table or counter where it can be pulled on by children or tripped over unintentionally.
9. Do not place on or near a hot gas or electric burner, or in a heated oven or microwave oven.
10. Do not use appliance for other than intended use.
11. Do not clean with metal scouring pads. Pieces can break off the pad and touch electrical parts involving a risk of electric shock.
12. The use of accessory attachments not recommended by the appliance manufacturer may cause serious injuries.
13. When operating the oven keep at least 4 inches of space on all sides of the oven to allow for adequate air circulation.
14. To disconnect, press the Start/Stop button during operation, and then remove the cord by grasping and pulling out the plug. Never unplug by pulling on the cord.
15. Extreme caution must be used when moving an appliance containing hot oil, or other hot liquids.
16. Do not cover any part of the Oven with metal foil. This may cause overheating of the Oven.
17. Use extreme caution when removing tray or disposing of hot grease or other hot liquids.
18. Oversized foods or metal utensils must not be inserted into the Oven, as they may create a fire or a risk of electric shock.

## SAFETY STANDARDS

---

19. While in operation, a fire may occur if the oven is covered or touching flammable material, including curtains, draperies, walls, and the like. Do not store, or lay any item on the oven during operation.
20. Extreme caution should be exercised when using containers constructed of anything other than metal or glass.
21. Do not place any of the following materials in the Oven: cardboard, plastic, paper, or other flammable materials.
22. Do not store any materials, other than manufacturers recommended accessories, in this Oven when not in use.
23. Always wear protective, insulated oven mitts when inserting or removing items from the hot Oven.
24. This appliance has a tempered, safety glass door. The glass is stronger than ordinary glass and more resistant to breakage. Tempered glass can break, but the pieces will not have sharp edges. Avoid scratching door surface or nicking edges. If the door has a scratch or nick, contact Anova immediately. [www.support.anovaculinary.com](http://www.support.anovaculinary.com)

25. To turn the Oven off, press and briefly hold the Start/Stop button during operation. Some lights and buttons will still be visible on the display when the unit is turned off.

### INITIAL SETUP

- ▶ Remove all the packaging and labels.
- ▶ Do not install or use a damaged appliance.
- ▶ Always take care when moving the appliance, as it is heavy. Wear closed-toed footwear to protect your feet.
- ▶ Do not pull or lift the oven by the handle.
- ▶ Keep a minimum distance of 4 inches from other appliances and units, walls or cabinets.

### ELECTRICAL CONNECTION

- ▶ The appliance must be plugged into a grounded outlet.
- ▶ Plug-in directly to a wall outlet.
- ▶ Do not use multi-plug adapters and extension cables.

# SAFETY STANDARDS

---

## USAGE

- ▶ This is a cooking appliance. Parts and accessories will be hot when in use. Use oven mitts and trivets to protect hands and surfaces from burns. Handle hot items carefully.
- ▶ This appliance is for household use only.
- ▶ Do not change the specification of this appliance.
- ▶ Do not leave children alone or unattended in the area where the Oven is in use.
- ▶ Make sure that the ventilation openings are not blocked. The area around the vent will be hot during and after use.
- ▶ Stand to the side and be careful when you open the door while the appliance is in operation. Hot air and steam can release.
- ▶ Do not apply pressure or rest items on the open door.
- ▶ Do not use the appliance as a work surface or as a storage surface.
- ▶ Do not use Anova accessories with other ovens or appliances. This can cause damage to the accessories.
- ▶ Open the Oven door carefully. The use of ingredients with alcohol can cause a mixture of alcohol and air.
- ▶ Do not let sparks or open flames to come in contact with the appliance when you open the door.
- ▶ Do not put flammable products or items that are wet with flammable products in, near or on the appliance.
- ▶ To prevent damage or discoloration to the steel:
  - do not put ovenware or other objects directly on the bottom of the Oven.
  - do not put aluminium foil directly on the bottom of the Oven.
  - do not keep moist dishes and food in the appliance after you finish cooking.
  - be careful when you remove or install the accessories.

## SAFETY STANDARDS

---

- ▶ Discoloration of the steel has no effect on the performance of the appliance.
- ▶ Use a deep pan for moist cakes. Fruit juices cause stains that can be permanent.
- ▶ This appliance is for cooking purposes only. It must not be used for other purposes, for example room heating.
- ▶ Always cook with the oven door closed.
- ▶ Do not position oven behind a furniture panel (e.g. a door) as heat and moisture can build up during operation that could cause subsequent damage to the appliance, the housing unit or the floor.

### STEAM COOKING

- ▶ Even when cooking without steam, steam may escape from the the Steam Exhaust Outlet below the Water Tank. Keep body parts and objects away from this area.
- ▶ Released steam can cause burns. Stand to the side and be careful when you open the door when the steam function is activated or after steam cooking. Keep bare hands and face away.

- ▶ Do not use the Oven close to cabinetry. Excessive steam use can cause damage to furniture and cabinetry.

### MAINTENANCE

- ▶ Before maintenance, deactivate the appliance and disconnect the plug from the power outlet.
- ▶ Make sure the appliance is cold. There is the risk that the glass panels can break.
- ▶ If the door glass panels get damaged or break, contact support immediately.
- ▶ Clean the appliance regularly to prevent deterioration of the surface material.
- ▶ Do not clean with any abrasive cleaning materials or agents, or metal objects.
- ▶ If you use an oven spray, obey the safety instructions on the packaging.

### SERVICE

Contact customer support:  
**support@anovaculinary.com**  
**www.support.anovaculinary.com**

## WELCOME

---

Thank you for choosing the Anova Precision® Oven!

We're excited to bring this amazing technology into your home. With the countertop, combi steam-enabled Anova Precision® Oven, you'll get the same high-quality and precise temperature control customers have come to expect from Anova, and so much more.

The Anova Precision® Oven will change the way you make everything. We can't wait to see what magic you cook up in the kitchen!

Cheers,

The Anova Team



## STOP! READ BEFORE PROCEEDING

Prepare the Oven before use. Refer to diagrams and information on pages 8–12 of this guide for operation details.

### HEATING ELEMENT PREPARATION

1. Make sure the Oven is situated in a well-ventilated area and plugged in.
2. Remove all original packaging, as well as accessories, from the appliance.
3. Set the oven to 356°F (180°C) using the **REAR HEATING ELEMENT** for 15 minutes and press **START**.
4. Allow the oven to cool. Open the door to allow air to ventilate out.
5. Set the oven at 356°F (180°C) using the **TOP AND BOTTOM HEATING ELEMENTS** for 15 minutes and press **START**.
6. Clean the appliance and the accessories before first use. Refer to “Care and Cleaning” section for details.

**NOTE:** The heating elements may create some vapors and odors as their coatings burn off.

### ATTACH PARTS

Install the Water Tank by sliding it from front to back along the right side of the Oven. Fill with distilled water. Do not overfill past the **MAX** water line.

Attach the included Drip Tray by sliding it under the Oven door with the open reservoir side facing up.

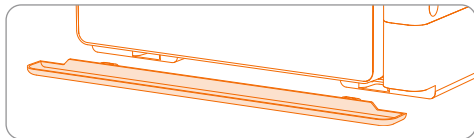

**NOTE:** Distilled water is recommended to minimize scale buildup and maintain correct operating function.

## YOUR OVEN

---

- ① Handle / Display Controls
- ② Drip Tray
- ③ Water Tank
- ④ Water Tank Lid
- ⑤ Steam Exhaust Outlet
- ⑥ Ventilation

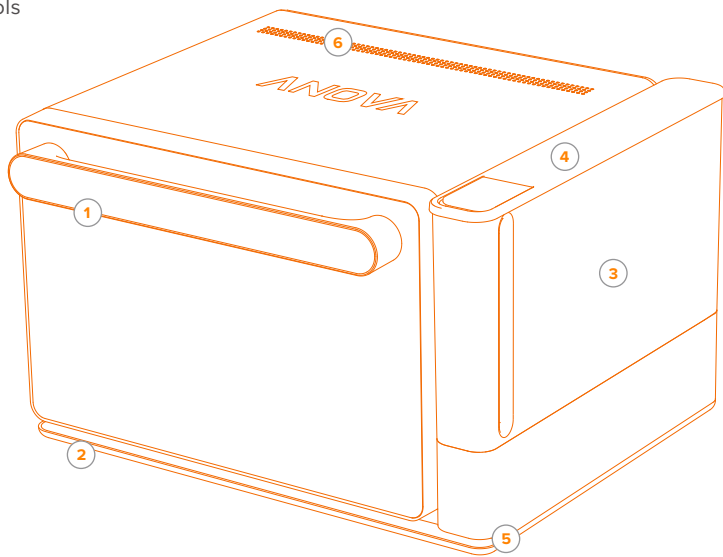

## INSIDE YOUR OVEN

---

- ① Food Probe Port
- ② Upper Heating Element
- ③ Rear Heating Element / Convection Fan
- ④ Lower Heating Element
- ⑤ Wet Bulb Sensor
- ⑥ Upper Temperature Sensor
- ⑦ Lower Temperature Sensor
- ⑧ Descale Drain Outlet
- ⑨ Tray Positions (5)
- ⑩ Light

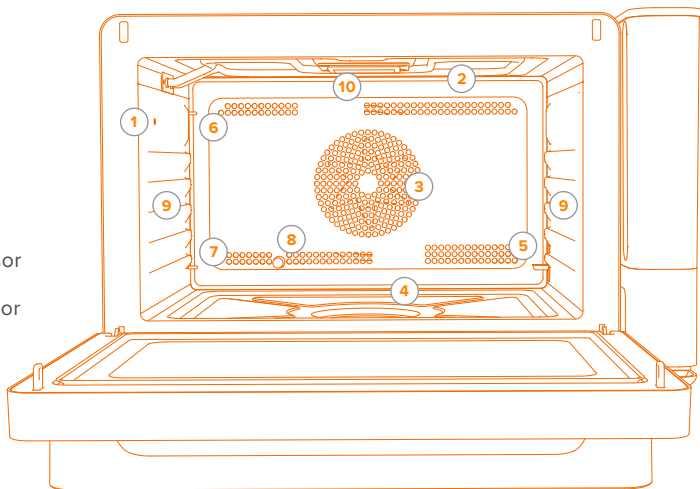

## DISPLAY CONTROLS

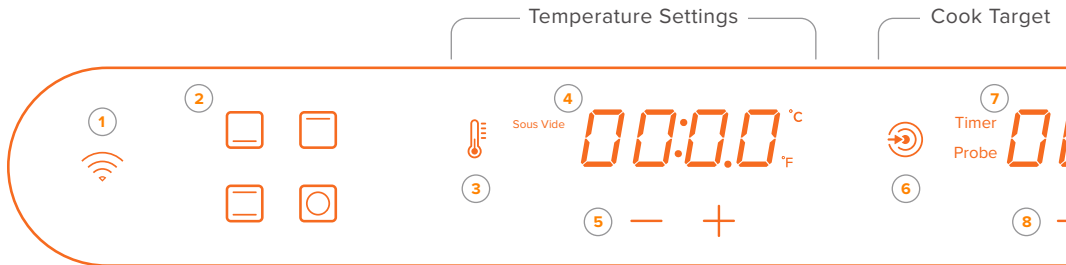

The handle of the door on the Anova Precision® Oven is also the touchscreen display.

Oven settings can be controlled manually from the display or the Anova Precision® Oven App.

- |   |  |   |                      |
|---|--|---|----------------------|
| 1 | Wi-Fi Connection Indicator   | 3 | Temperature Mode     |
| 2 | Heating Element Selector   | 4 | Temperature Display  |
|   | <ul style="list-style-type: none"><li>• Bottom</li><li>• Top</li><li>• Both</li><li>• Rear</li></ul> | 5 | Temperature Controls |

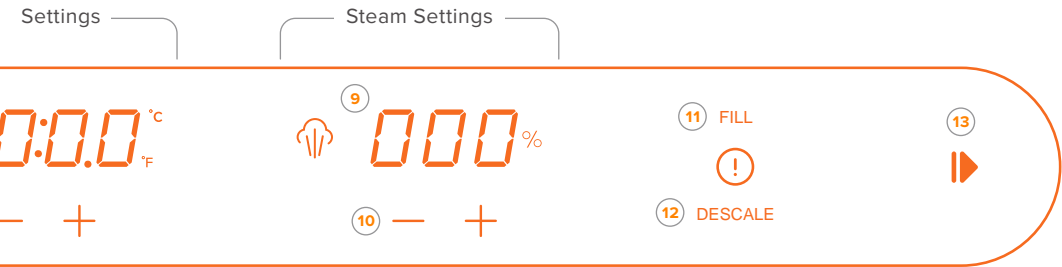

6 Cook Target Selector

7 Cook Target Display

8 Cook Target Controls

9 Steam Display

10 Steam Controls

11 Fill Water Tank Indicator

12 Descale Indicator

13 Start/Stop

**NOTE:** The Start/Stop button will turn from white to red if there is an error.

## HEATING ELEMENTS

---

The Anova Precision® Oven has three heating elements and a fan. Choosing your heating elements is separate from setting temperature targets.



**REAR ELEMENT** 1600 W, max 482°F (250°C)

The Rear Heating Element is located behind the back wall of the oven cavity. It wraps around the Convection Fan, which helps to circulate heat throughout the oven.

**BEST FOR:**

- air-frying
- bread baking
- browning roasts or poultry
- Sous Vide Mode

**NOTE:** The convection fan will always run at high speed while the rear element is in use.



**TOP ELEMENT** 1600 W, max 482°F (250°C)

The Top Heating Element is located inside the oven ceiling. This element is the best choice when you want intense, direct, heat.

**BEST FOR:**

- searing
- toasting



**BOTTOM ELEMENT** 700 W, max 356°F (180°C)

The Bottom Heating Element is under the floor of the oven. This element is lower power than the others, and the best choice when you want low, gentle, indirect heating.

**BEST FOR:**

- proofing
- fermentation
- dehydrating

**NOTE:** Using both Top and Bottom Elements together is best for recipes based on traditional baking.

## INCLUDED ACCESSORIES

---

- 1 Wire Rack (2)
- 2 Solid Pan
- 3 Food Probe

**NOTE:** The stainless steel pan and wire rack included with the Anova Precision® Oven are designed to work with the Anova Precision® Oven. Do not use the pans with other ovens or appliances, as it may result in damage to the pans, which will cause them to no longer work with the Anova Precision® Oven as designed.

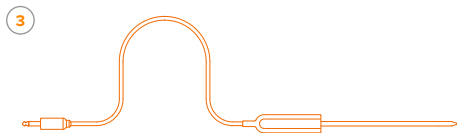
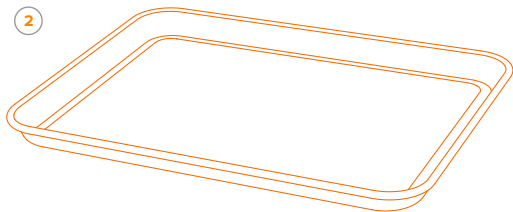
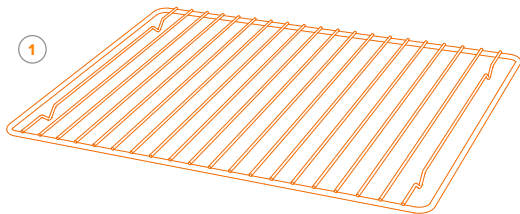

## SETTINGS

---

These pages refer to the Display diagram found on Page 10-11.

### TEMPERATURE AND COOK TARGET

 Press **TEMPERATURE MODE** to turn Sous Vide Mode on or off.

Hold for 5 seconds to change unit of temperature (F°/C°).

Press or hold the + **AND - TEMPERATURE CONTROLS** to adjust temperature.

 Press **COOK TARGET** to switch between **TIMER** or **PROBE**. The display will change depending on the target you have selected.

Press or hold the + **AND - COOK TARGET CONTROLS** to adjust the **TIMER** or **PROBE** target temperature.

 Press **START/STOP** to start cooking after choosing settings, or to stop cooking at any time.

**NOTE:** You can cook a recipe based on meeting a temperature, instead of completing an amount of time. A timer is not required to begin cooking.

### TEMPERATURE RANGE

**SOUS VIDE MODE ON:** 77–212°F (25–100°C)

**SOUS VIDE MODE OFF:** 77–482°F (25–250°C)

### SOUS VIDE MODE

**SOUS VIDE MODE** is an innovative method of cooking with the Anova Precision® Oven. It enables you to cook foods similar to traditional sous vide, where your food gently reaches precise, edge-to-edge doneness, without overcooking. You can use the same cooking times and temperatures you're used to from sous vide, but with the added benefit of no longer needing to seal your food or fill a tub of water.

## SETTINGS

---

When Sous Vide Mode is on, the Oven continuously measures the temperature your food experiences using the state-of-the-art **WET BULB SENSOR**. This sensor measures the temperature of water evaporation throughout your cook, and the Oven regulates that temperature so that your food never cooks past your setting.

Just as in sous vide, foods will not brown or crisp using Sous Vide Mode. In order to finish your food with searing, browning, or a crispy texture, add a separate Cooking Stage with high heat and Sous Vide Mode turned off. You can program Cooking Stages for your recipe in the Anova Precision® Oven App, or manually input new settings on the Display.

### USING THE FOOD PROBE

Use the **FOOD PROBE** to measure the core temperature of your food as it cooks. Insert the probe into the thickest part, or the center, of your food. As you slide your pan into the Oven, connect the opposite end of the probe cable into the Food Probe Port, located in the upper left corner inside the Oven (see page 5). Both the Oven display and the Anova Precision® Oven App will show you the core temperature of the food while the probe is in use, and allow you to input your desired core temperature while cooking. The Food Probe can be used with Sous Vide Mode on or off.

**NOTE:** The Food Probe measures core food temperature up to 212°F (100°C).

## SETTINGS

---

This page refers to the Display diagram on Page 10-11.

### USING STEAM

 Press the + **OR - STEAM CONTROLS** to adjust Steam percentage.

To stop using steam, press the - **STEAM CONTROL** until the percentage reaches 0 and the display says “OFF”.

 If the Water Tank is empty during or before cooking with Steam, the **FILL INDICATOR** will blink. Fill the Water Tank, then press the Fill Indicator to continue the flow of Steam.

**NOTE:** The Oven can't dehumidify the air beyond the humidity in your own kitchen. If you are cooking in a humid environment, the Oven may not be able to reach low Relative Humidity inputs.

### STEAM GENERATION

You can add steam to the cooking process by specifying a Steam Percentage (0–100%) on the Display or in the App. This will activate the boiler to add humidity inside the Oven.

When cooking at 212°F (100°C) or lower, the Steam Percentage you set is interpreted as a Relative Humidity percentage. In this temperature range, the Oven only activates the boiler when necessary to maintain humidity levels, which may be infrequent.

However, when used at temperatures above 212°F (100°C), Steam is generated constantly throughout the cooking process. In this mode, the Oven does not measure or react to the amount of humidity inside.

## CONNECT TO WI-FI

---

Connecting your Oven to the Anova Precision® Oven App with Wi-Fi gives you the ultimate cooking experience.

- 1 **DOWNLOAD** the Anova Precision® Oven App on your smartphone or tablet.
- 2 **CONNECT** to your preferred Wi-Fi network.
- 3 **OPEN** the app and follow the on-screen instructions to connect.



### ON THE OVEN DISPLAY

The Wi-Fi icon on the Oven Display will show your connection status.

**PULSING LIGHT:** searching/connecting

**SOLID LIGHT:** connected

### BENEFITS OF USING THE APP

- ▶ Set your Oven remotely, and monitor the cooking process from anywhere.
- ▶ Browse and cook from a collection of easy-to-follow recipes made exclusively for Anova.
- ▶ Make and share your own recipes, with ingredients, steps, and photos.
- ▶ Save all your favorite recipes.

**NOTE:** Wi-Fi connection and the App are not required to use the Oven. However, some functions may not be available with manual use.

## CARE AND CLEANING

---

### GENERAL CLEANING

- ▶ Clean the front of the appliance with a soft cloth with warm water and a cleaning agent.
- ▶ To clean metal surfaces, use a stainless-steel cleaner.
- ▶ In case of mineral buildup on the bottom of the interior, use some drops of distilled vinegar with warm water and a soft sponge.
- ▶ Clean the appliance interior after each use. Fat accumulation or other food remains may result in a fire.
- ▶ Clean stubborn dirt with an oven cleaner.
- ▶ Do not use abrasive scrubbers or cleaning agents. These can cause damage to the Oven finishes and parts.

### ACCESSORIES

- ▶ For the Food Probe, clean with warm water and dish soap. Do not submerge the probe in water or put in the dishwasher.
- ▶ Included pans and wire rack are dishwasher safe, or can be hand-washed. Do not clean them using abrasive agents or scrubbers or sharp-edged objects. These can cause damage to the stainless steel.
- ▶ Clean all accessories after each use and let them dry completely.
- ▶ Check and empty the Drip Tray before and after each cook to ensure it does not overflow.

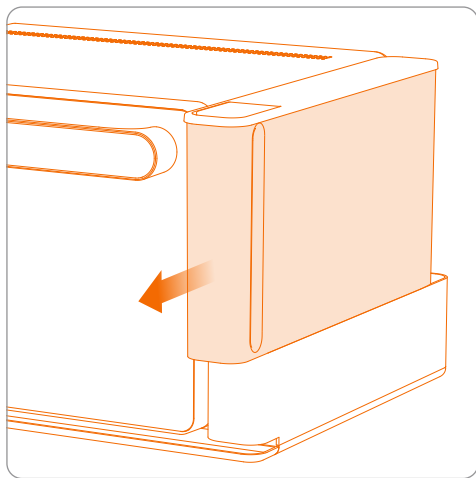

*figure 1: removing the Water Tank*

## **CLEANING THE WATER TANK**

1. Remove the water tank by sliding outwards as shown in fig. 1.
2. Remove the lid of the water tank.
3. Gently wash the tank and lid with a soft cloth or non-abrasive sponge with warm water and dish soap.
4. Carefully dry the Water Tank with a microfiber cloth, then slide it back into position on the side of the oven.
5. Fill the Water Tank with fresh distilled water and replace the lid on the tank.

**NOTE:** Tank and lid are not dishwasher safe.

## DESCALE CYCLE

---

When the steam generator operates, there is an accumulation of limestone inside because of calcium content in the water. Periodic descaling of residual buildup can increase the life span of your Oven and prevent any decline in performance.

Descaling is recommended after 30 hours of steam usage. The automated Descale cycle takes about 40 minutes to complete.

You will need a descaling solution and water to perform this cycle.

**NOTE:** Distilled water is recommended to help maintain correct operating function.

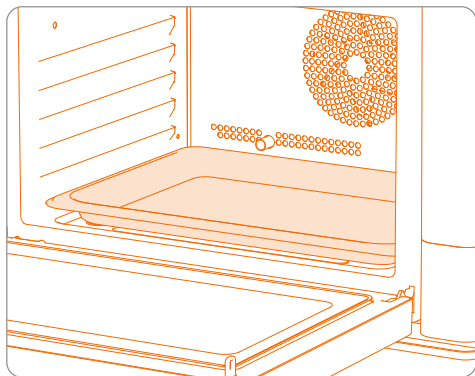

*figure 2: pan placement during descaling*

## DESCALE CYCLE

---

### DESCALING STEPS

1. Remove all accessories. Put the solid pan on the bottom of the cavity so that the Descale drain outlet is protruding out over the edge of the tray to catch liquids. See fig. 2.
2. Remove and empty the water tank, then re-attach to the oven.
3. Mix 3/4 Cup (about 200 mL) descaling solution with 1 Quart (1 L) water, and pour into the Water Tank.
4. Activate the Descale cycle by pressing the **DESCALE INDICATOR** on the Display or in the App. The first phase is about 30 minutes.
5. After the end of the first stage, make sure there is no remaining cleaning solution inside the Water Tank. If there is, remove the tank, empty the solution, rinse the tank with water, and re-attach.
6. Add 1 Quart (1 L) distilled water to the Water Tank.
7. Activate the second phase of the cycle by pressing the **DESCALE INDICATOR** on the Display or in the App. The second phase is about 10 minutes.
8. When the cycle is complete, remove the solid pan and clean the pan.
9. Wipe away any moisture inside of the Oven with a dry cloth. Let it dry fully with the door open.

## REPLACE LIGHT BULB

---

The Anova Precision® Oven uses a high temperature G9 Halogen Lamp, 120 V, 25 W inside the cavity. If the light requires replacement, follow these steps:

1. Unplug the oven from the power supply
2. Ensure the oven is cool before attempting.
3. Open the door and look to the upper surface of the cavity.
4. Carefully remove all four screws that hold the light cover in place. See fig. 3.
5. While removing the fourth and final screw, place a hand over the cover to avoid it falling off.
6. Set the cover aside.
7. Carefully grasp the bulb and pull it straight out of the socket (towards the front of the oven).

8. Insert a new bulb and follow these steps in reverse to re-assemble

**NOTE:** Do not overtighten the screws as this could cause damage to the glass.

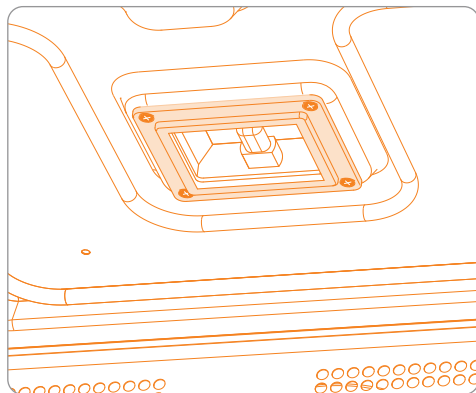

*figure 3: light cover and screws*

## FCC/IC COMPLIANCE

This device complies with Part 15 of the FCC Rules / Innovation, Science and Economic Development Canada's licence-exempt RSS(s). Operation is subject to the following two conditions: (1) this device may not cause harmful interference. (2) this device must accept any interference received, including interference that may cause undesired operation.

L'émetteur/récepteur exempt de licence contenu dans le présent appareil est conforme aux CNR d'Innovation, Sciences et Développement économique Canada applicables aux appareils radio exempts de licence. L'exploitation est autorisée aux deux conditions suivantes : (1) L'appareil ne doit pas produire de brouillage; (2) L'appareil doit accepter tout brouillage radioélectrique subi, même si le brouillage est susceptible d'en compromettre le fonctionnement.

Changes or modifications not expressly approved by the party responsible for compliance could void the user's authority to operate the equipment.

This equipment has been tested and found to comply with the limits for a Class B digital device, pursuant to part 15 of the FCC Rules. These limits are designed to provide reasonable protection against harmful interference in a residential installation. This equipment generates uses and can radiate radio frequency energy and, if not installed and used in accordance with the instructions, may cause harmful interference to radio communications. However, there is no guarantee that interference will not occur in a particular installation. If this equipment does cause harmful interference to radio or television reception, which can be determined by turning the equipment off and on, the user is encouraged to try to correct the interference by one or more of the following measures:

- Reorient or relocate the receiving antenna.
- Increase the separation between the equipment and receiver.
- Connect the equipment into an outlet on a circuit different from that to which the receiver is connected.
- Consult the dealer or an experienced radio/TV technician for help.

## MPE REMINDER

To satisfy FCC / IC RF exposure requirements, a separation distance of 20 cm or more should be maintained between the antenna of this device and persons during device operation. To ensure compliance, operations at closer than this distance is not recommended.

La FCC des états-unis stipule que cet appareil doit être en tout temps éloigné d'au moins 20 cm des personnes pendant son fonctionnement. Installer l'antenne de façon à ce que le personnel ne puisse approcher à 20 cm ou moins de la position centrale de l'antenne.

Limited warranty. Full details at [anovaculinary.com/warranty](https://anovaculinary.com/warranty)

Anova®, Precision®, Precision® Cooker, and HemiFlow™ are trademarks or registered trademarks of Anova Applied Electronics, Inc. ©2020 Anova Applied Electronics, Inc. San Francisco, CA, US | Stockholm, SE. All Rights Reserved.

Apple, the Apple logo and iPhone are trademarks of Apple Inc., registered in the U.S. and other countries. App Store is a service mark of Apple Inc. Android, Google Play, and the Google Play logo are trademarks of Google Inc. All other trademarks and trade names are properties of their respective owners.

**ANOVA CULINARY**



**ANOVACULINARY.COM**

SUPPORT@ANOVACULINARY.COM