

CROWNFUL

CROWNFUL AIR FRYER

USER MANUAL

Model No.: AFT05001-UL



5 QT AIR FRYER WITH TOUCHSCREEN

Read this manual thoroughly before using and save it for future reference.
For product concerns, please contact support@crowful.com

Table of Contents

Important Safeguards	2
Additional Important Safeguards	3
Notes on the Plug	4
Electric Power.....	4
A Versatile Appliance	4
Getting to Know Your Air Fryer	5
Touchscreen Control	6
Preset Button Cooking Chart	7
Before Using for the First Time	8
Operating Instructions	8–10
Helpful Hints	10
Air Frying Chart	11
Please Note	12
User Maintenance Instructions	12
Care & Cleaning Instructions	12
Storing Instructions	12

IMPORTANT SAFEGUARDS

When using electrical appliances, basic safety precautions should always be followed, including the following:

1. **READ ALL INSTRUCTIONS.**
2. Do not touch hot surfaces. Use handles or knobs. Use oven mitts or potholders.
3. To protect against electric shock do not immerse cord, plugs, or appliance in water or other liquid.
4. This appliance is not intended for use by persons (including children) with reduced physical, sensory or mental capabilities, or lack of experience and knowledge, unless they have been given supervision or instruction concerning use of the appliance by a person responsible for their safety.
5. Children should be supervised to ensure that they do not play with the appliance.
6. Unplug from outlet when not in use and before cleaning. Allow to cool before putting on or taking off parts, and before cleaning the appliance
7. Do not operate any appliance with a damaged cord or plug or after the appliance malfunctions, or has been damaged in any manner. Bring it to a qualified technician for examination, repair or electrical or mechanical adjustment.
8. The use of accessory attachments not recommended by the appliance manufacturer may cause injuries.
9. Do not use outdoors.
10. Do not let cord hang over edge of table or counter, or touch hot surfaces.
11. Do not place on or near a hot gas or electric burner, or in a heated oven.
12. Extreme caution must be used when moving an appliance containing hot oil or other hot liquids.
13. To disconnect, turn both the timer dial and temperature dial to OFF. Then remove plug from wall outlet.
14. Do not use appliance for other than intended use.
15. Make sure the basket is locked into the Air Fryer.
16. Make sure the frying basket is locked securely into the front of the Air Fryer, while the Air Fryer is in operation.

WARNING: The Air Fryer will not operate unless frying basket is fully closed.

CAUTION: After hot air frying, the crisping tray and frying basket drawer and the cooked foods are hot. Extreme caution must be observed when handling the hot Air Fryer basket /drawer.

FOR HOUSEHOLD USE ONLY

ADDITIONAL IMPORTANT SAFEGUARDS

CAUTION HOT SURFACES : This appliance generates heat and escaping steam during use. Proper precautions must be taken to prevent the risk of burns, fires, or other injury to persons or damage to property.

CAUTION: This appliance is hot during operation and retains heat for some time after turning OFF. Always use oven mitts when handling hot materials and allow metal parts to cool before cleaning. Do not place anything on top of the appliance while it is operating or while it is hot,

1. All users of this appliance must read and understand this instruction manual before operating or cleaning this appliance.
2. The cord to this appliance should be plugged into a 120V AC electrical outlet only.
3. If this appliance begins to malfunction during use, immediately unplug the cord. Do not use or attempt to repair the malfunctioning appliance.
4. Do not leave this appliance unattended during use.
5. Do not immerse power cord in any liquid. If the power cord to this appliance is damaged, it must be replaced by contacting Consumer Service.
6. Keep the cord out of reach from children and infants to avoid the risk of electric shock and choking.
7. Place the Air Fryer on a flat, heat-resistant work area.
8. Do not obstruct the air outlet or air inlets on the back and sides of the Air Fryer, with any objects. Avoid escaping steam from the air outlet during air frying.
9. Keep appliance at least 4 inches away from walls or other objects during operation.
10. Always use the frying basket handle to open frying basket drawer.
11. **WARNING : After air frying, make sure to place the frying basket on a flat, heat-resistant surface.**
12. **WARNING** Under or over-filling the frying basket may damage the Air Fryer and could result in serious personal injury.
13. Never move a hot Air Fryer or an Air Fryer containing hot food. Allow to cool before moving.

SAVE THESE INSTRUCTIONS

NOTES ON THE PLUG

This appliance has a polarized plug (one blade is wider than the other). To reduce the risk of electric shock, this plug will fit in a polarized outlet only one way. If the plug does not fit fully into the outlet, reverse the plug. If it still does not fit, contact a qualified electrician. Do not modify the plug in any way.

ELECTRIC POWER

If the electrical circuit is overloaded with other appliances, your appliance may not operate properly. It should be operated on a separate electrical circuit from other appliances.

A Versatile Appliance

The Fryer is designed to cook a wide variety of your favorite foods. The charts and tables provided within this manual and the Recipe Guide will help you get great results. Please refer to this information for proper time/temperature settings and proper food quantities.

Getting to Know Your Air Fryer

Product may vary slightly from illustration

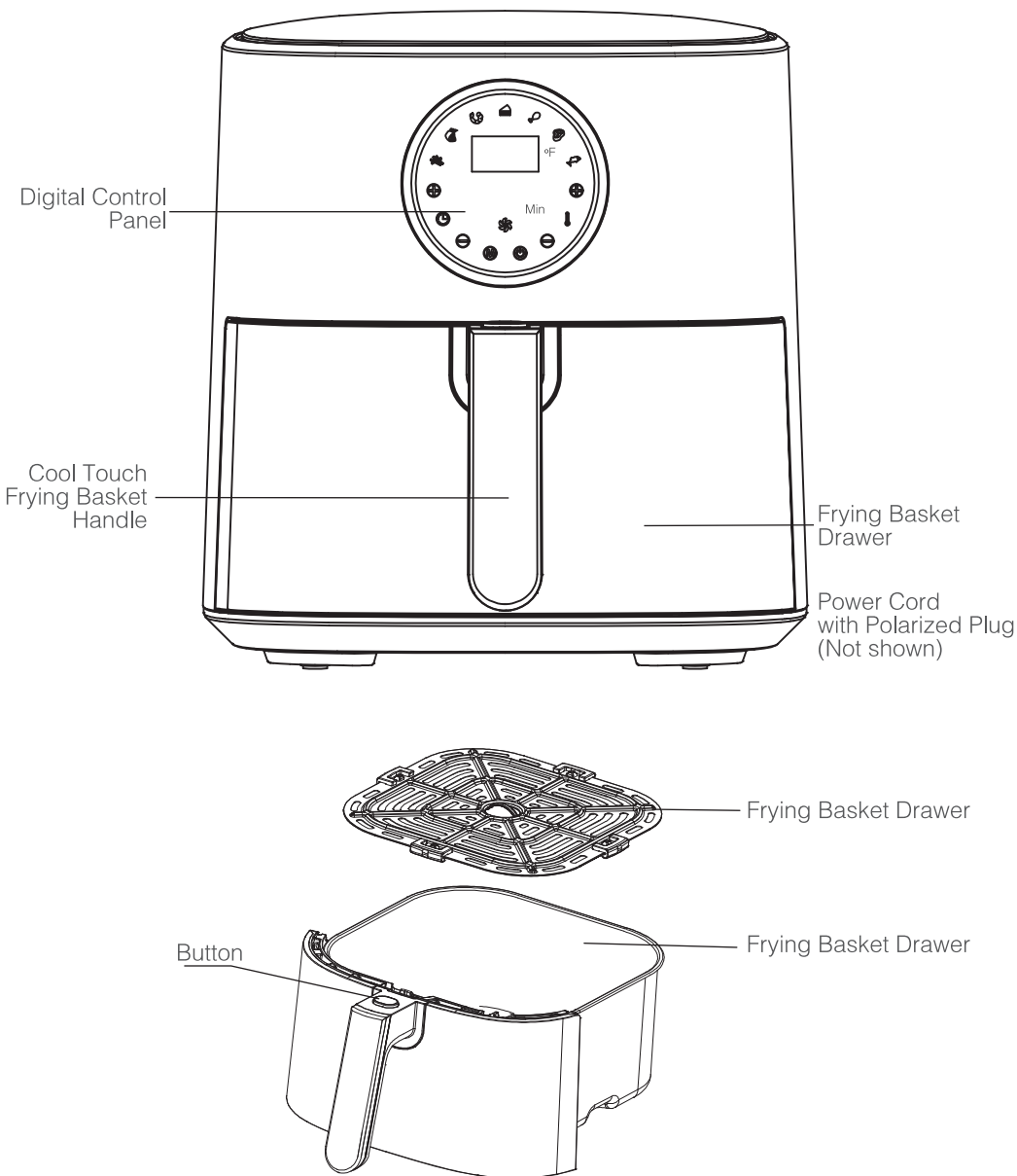

Touchscreen Control



Power Button

Once the Outer Basket and Fry Basket are properly placed in the Main Unit Housing, the Power Button will be illuminated. Selecting the Power Button one time will set the Unit to a default temperature of 370°F and the cooking time will be set to 15 minutes. Selecting the Power Button a second time will start the cooking process. Pressing the Power Button during the cooking cycle will turn the Unit off. The White Fan Icon will continue to flash for 20 seconds.

Timer Control Buttons

The + and – symbols enable you to add or decrease cooking time, one minute at a time. Keeping the button held down will rapidly change the time.

Temperature Control Buttons

The + and – symbols enable you to add or decrease cooking temperature 5°F at a time. Keeping the button held down will rapidly change the temperature. Temperature control range: 180°F – 400°F

Preset Button

Selecting the M Preset Button enables you to scroll through the seven Preset Buttons. Once selected, the predetermined time and cooking temperature function begins.

Note: You can override the Preset function by increasing or decreasing Time and Temperature manually

Preset Choices

Seven Presets to choose from: French Fries, Roast, Shrimp, Cake, Chicken, Steak, and Fish.







Time and Temperature

This display will keep track of the temperature and remaining cook time.

Fan Icon

The flashing Red Fan Icon will appear when the unit is turned on. After it is turned off, the flashing Fan Icon will be changed into white for up to 20 seconds.

Preset Button Cooking Chart

	Food	Default Temp	Default Air Time	Time range/ mins	Temp range	Recommend turn time	Action
	French Fries, Idaho Potatoes , 2–3 cups (fresh, hand cut, 1/4 to 1/3–in thick)	400°F	20 mins	1–60mins	180–400°F	Turn over 1 time for each 9 mins	Spray with oil, shake 3x
	Meat, Roast, Chops , 1–2 lbs.	360°F	20 mins	1–60mins	180–400°F	Turn over 1 time for each 13 mins	rub or spray with oil, turn over, test for doneness
	Shrimp , (tawed, battered), 1 lb.	320°F	8 mins	1–60mins	180–400°F	Turn over 1 time for each 4 mins	spray with oil, turn over, shake
	Cake , 1 layer, 7–inch	300°F	40 mins	1–60mins	180–400°F	No turn over	test for doneness
	Chicken , 1 lb. (fresh/ thawed)	400°F	20 mins	1–60mins	180–400°F	Turn over 1 time for each 10 mins	rub or spray with oil, turn over, test for doneness
	Steak , 1 lb., room temp., medium rare	400°F	15 mins	1–60mins	180–400°F	Turn over 1 time for each 6 mins	rub or spray with oil, turn over, test for doneness
	Fish Filet , 1 lb., fresh, thawed, battered	360°F	10 mins	1–60mins	180–400°F	Turn over 1 time for 5 mins	spray with oil, turn over, test for doneness

WARNING: Never fill the Outer Basket with cooking oil or any other liquid! Fire hazard or personal injury could result.

E1: Malfunction or short circuit for the internal wire, please take a picture and contact us.

E2: Malfunction or short circuit for the internal wire, please take a picture and contact us.

Before Using for the First Time

1. Your Air Fryer is shipped with the crisping tray locked into the drawer, inside the Air Fryer body. Firmly grasp the frying basket handle to open frying basket drawer; then remove the drawer from the machine and place on a flat, clean work area.
2. Remove all packing material and labels from the inside and outside of the Air Fryer. Check that there is no packaging underneath and around the frying basket and drawer.
3. Wash frying basket and crisping tray in hot, soapy water.
4. DO NOT IMMERSE THE AIR FRYER BODY IN WATER. Wipe Air Fryer body with a damp cloth. Dry all parts thoroughly.
5. Following the shape of the frying basket, turn the crisping tray with the flattened edge facing the handle. Use the center hole of the crisping tray to lift crisping tray up and out of the frying basket. (See Figure 2.) Drop the tray down so that the 4 rubber side grips fit snugly in place in the base of the basket. (See Figure 2).
6. Insert and lock the clean frying basket into the front of the Air Fryer.

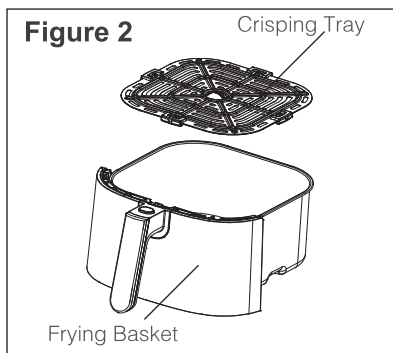

Operating Instructions

WARNING! This unit should not be used to boil water.

NOTE: During first use, the Air Fryer may emit a slight odor. This is normal.

1. Place the Air Convection Fryer on a flat, heat-resistant work area, close to an electrical outlet.
2. Firmly grasp the frying basket handle to open frying basket drawer; then remove the drawer from the body and place on a flat, clean surface,
3. Place food into the frying basket. Do not overfill. To ensure proper cooking and air circulation, NEVER fill the frying basket more than 2/3 full. When air frying fresh vegetables, we do not recommend adding more than 3 cups of food to the frying basket.
4. Insert the assembled frying basket drawer into the front of the Air Convection Fryer. Always make sure frying basket drawer is fully closed.
5. Plug cord in the wall outlet. A lone red POWER will appear on a black background.
6. To begin, press the red POWER .

7. The control panel will appear, POWER turns White.
8. The default **TIME** and **TEMPERATURE**: 15 minutes and 370°F will alternate on the display
9. To adjust the air frying **TIME**, press the (+) or (-) on the left side of the control panel to advance or decrease time in 1 minute increments, from 1 to 60 minutes.
10. Press the (+) or (-) on the right side of the control panel to adjust **TEMPERATURE** 180°F to 400°F in 5 degree increments.

Figure 4

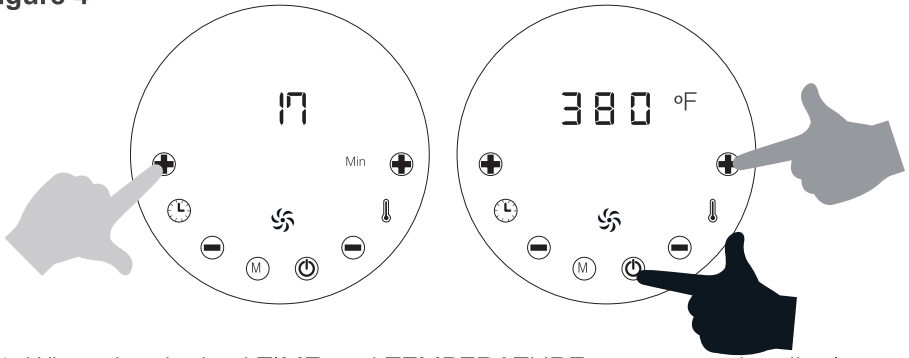









11. When the desired TIME and TEMPERATURE appear on the display, press the White POWER  to turn the Air Convection Fryer ON. The Red convection fan  will twirl when the Air Convection Fryer is in operation. The preset temperature and time will alternate on the display until the time has expired. **IMPORTANT:** The Air Convection Fryer will not heat until the white power  is pressed. If no buttons are pressed in 15 minutes, the Air Convection Fryer will automatically turn OFF.
12. To turn the Air Convection Fryer OFF at any time, simply press the white POWER . The white convection fan  will continue to twirl 20 seconds until the lone red POWER  will appear on a black background. 5 beeps will sound.
13. To use preset menu options, simply press MENU (M). Each time MENU (M) is pressed, the next menu option will illuminate.

Figure 5

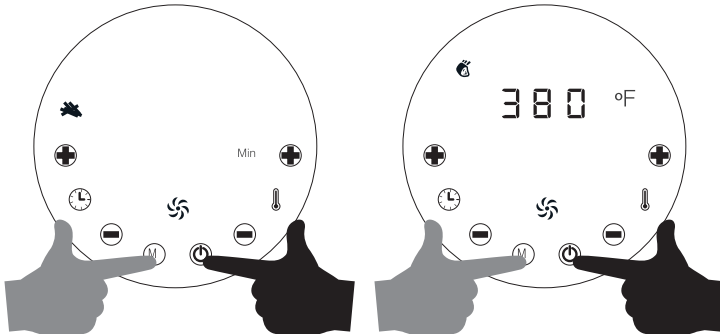

14. When the desired menu option icon is flashing, press the white POWER  to turn the Air Convection Fryer ON.
15. The Red convection fan  will twirl when the Air Convection Fryer is in operation. The preset temperature and time will alternate on the display until the air fry time has expired.
16. The quantity, density, weight of food will alter the total cooking time necessary. Remember, frying smaller batches will result in shorter cooking times and higher food quality.
17. You can pull out the basket anytime when frying. The Air Fryer will pause and you can shake, mix, or flip the food. Put it back into the air fryer to resume the remaining cooking time.

IMPORTANT: Always check food halfway through cooking time to determine final cook time and temperature.

WARNING! ALWAYS USE A MEAT THERMOMETER TO ENSURE THAT MEAT AND FISH ARE COOKED THOROUGHLY BEFORE EATING.

Helpful Hints

1. Olive oil spray or vegetable oil works well for air frying.
2. Use your Air Fryer to cook pre-packaged foods with a fraction of the oil, in a fraction of the time! As a general rule, lower the recipe baking temperature by 50° F and reduce the cooking time by 30% to 50% depending on the food and amount.
3. Do not overfill frying basket with food. NEVER fill any frying basket more than 2/3 full. When air frying fresh vegetables, we do not recommend adding more than 3 cups of food to the frying basket.
4. **For best results**, some foods need to be shaken vigorously or turned over during the air fry time. Consult the Air Frying Chart following as a general guide.
5. To avoid excess smoke, when cooking naturally high fat foods, such as chicken wings or sausages, it may be necessary to empty fat from the frying basket drawer between batches.
6. Always pat food dry before cooking to encourage browning and avoid excess smoke.
7. Air fry small batches of freshly breaded foods. Press breading onto food to help it adhere. Arrange in frying basket so that food is not touching to allow air flow on all surfaces.
8. The Air Fryer can be used to reheat food. Set the temperature to 300°F for up to 10 minutes.

Air Frying Chart

WARNING! ALWAYS USE A MEAT THERMOMETER TO ENSURE THAT MEAT, POULTRY AND FISH ARE COOKED THOROUGHLY BEFORE EATING.

The following chart is intended as a guide only. The quantity of food air fried at one time, the thickness or density of the food, and whether the food is fresh, thawed, or frozen may alter the total cooking time necessary.

1. To assure even cooking/browning, open the frying basket drawer halfway through the cooking time. Check, turn or vigorously shake foods in the frying basket. This chart lists average total air frying time, the time at which some action is required, and what action is to be taken for best results.
2. Remember, frying smaller batches will result in shorter cooking times and higher food quality. Adjust air frying temperatures and times as necessary to suit your taste.

IMPORTANT NOTE: Unless food is pre-packaged and pre-oiled, for browned and crispy results, all foods should be lightly oiled before air frying.

- Oil may be sprayed or brushed onto foods.
- Spray oils work well as oil is evenly distributed and smaller quantities of oil are needed.
- To ensure crispy results, make sure foods are dried before adding oil.
- Cut pieces smaller to create more surface area for crispier results.
- Blanching is a term that refers to pre-cooking foods at a lower temperature before the final air fry.
- Add 3 minutes to the AIR FRY TIME to allow the Air Fryer to preheat.

FOOD	TEMP	AIR FRY TIME*	TIME	ACTION
Mixed Vegetables (roasted)	400°F	15 – 20 minutes	8 minutes	shake
Broccoli (roasted)	400°F	15 – 20 minutes	8 minutes	shake
Onion Rings (frozen)	400°F	12 – 18 minutes	8 minutes	shake
Cheese Sticks (frozen)	350°F	8 – 12 minutes	—	—
Fried Sweet Potato Chips (fresh, hand cut, 1/8 to 1/16-in. thick)				
Blanch (Step 1)	325°F	15 minutes	8 minutes	shake
Air Fry (Step 2)	350°F	10 – 15 minutes	5 minutes	shake
French Fries, (fresh, hand cut, 1/4 to 1/3-in. thick)				
Blanch (Step 1)	325°F	15 minutes	8 minutes	shake
Air Fry (Step 2)	350°F	10 – 15 minutes	5 minutes	shake
French Fries, thin (frozen) 3 cups	400°F	12 – 16 minutes	8 minutes	shake
French Fries, thick (frozen) 3cups	400°F	17 – 21 minutes	10 minutes	shake
Meatloaf, 1 lb.	350°F	35 – 40 minutes	—	—
Hamburgers, 1/4 lb. (up to 4)	350°F	10 – 14 minutes	(rare to well done)	—
Hot Dogs /Sausages	350°F	10 – 15 minutes	6 minutes	turn over
Chicken Wings (fresh/thawed),				
Blanch (Step 1)	325°F	15 minutes	8 minutes	shake
Air Fry (Step 2)	350°F	10 minutes	5 minutes	shake
Chicken Tenders/Fingers,				
Blanch (Step 1)	350°F	13 minutes	13 minutes	turn over
Air Fry (Step 2)	400°F	5 minutes	3 minutes	shake
Chicken Pieces	350°F	20 – 30 minutes	10 minutes	turn over
Chicken Nuggets (frozen)	350°F	10 – 15 minutes	5 minutes	shake
Catfish Fingers (thawed, battered)	400°F	10 – 15 minutes	5 minutes	turn over
Fish Sticks (frozen)	400°F	10 – 15 minutes	5 minutes	turn over
Apple Turnovers	400°F	10 minutes	—	—
Donuts	350°F	8 minutes	4 minutes	turn over
Fried Cookies	350°F	8 minutes	4 minutes	turn over

*Add 3 minutes to the AIR FRY TIME to allow the Air Fryer to preheat.

PLEASE NOTE

The USDA recommends that meats such as beef and lamb, etc. should be cooked to an internal temperature of 145°F/63°C. Pork should be cooked to an internal temperature of 160°F/71°C and poultry products should be cooked to an internal temperature of 170°F/77°C –180°F/82°C to be sure any harmful bacteria is destroyed. When reheating meat/poultry products, they should also be cooked to an internal temperature of 165°F/74°C

User Maintenance Instructions

This appliance requires little maintenance. It contains no user-serviceable parts. Any servicing requiring disassembly other than cleaning must be performed by a qualified appliance repair technician.

Care & Cleaning Instructions

WARNING! Allow the Air Fryer to cool fully before cleaning.

1. Unplug the Air Fryer. Remove frying basket from the drawer. Make sure the frying basket drawer and frying basket have cooled completely before cleaning.
2. Wash the basket drawer and frying basket in hot soapy water. Do not use metal kitchen utensils or abrasive cleansers or cleaning products as this may damage the non-stick coating.
3. The frying basket and frying basket drawer are dishwasher-safe. For best results, place in the top rack of your dishwasher to clean.
4. Wipe the Air Fryer body with a soft, non-abrasive damp cloth to clean.

Storing Instructions

1. Make sure the Air Fryer is unplugged and all parts are clean and dry before storing.
2. Never store the Air Fryer while it is hot or wet.
3. Store Air Fryer in its box or in a clean, dry place.



Thanks for trusting Crownful
for your household and kitchen needs!

(May you have a FANTASTIC culinary experience with your new Crownful Air Fryer)



START COOKING delectable yet healthier meals
using your free CROWNFUL air fryer recipe book



SUBSCRIBE to our newsletter to get yourself
updated with latest great deals, gifts and valuable
information about Crownful products.
<https://www.facebook.com/crownful.official>



GOT QUESTIONS or CONCERNS?
Please contact support@crowful.com

12
Months

WARRANTY ISSUE

Email: support@crowful.com



Scan to Follow Us



@crowful.official
Website: www.crownful.com

Ver.2022119