



**Infuture H1 headphone**  
**USER MANUAL**

English	01
Deutsch	10
Italiano	19
Français	28
Español	37

## Packing list



1



2

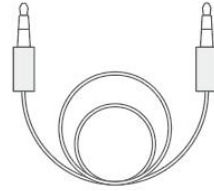

4

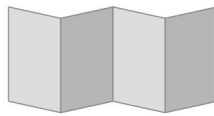



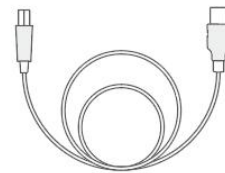





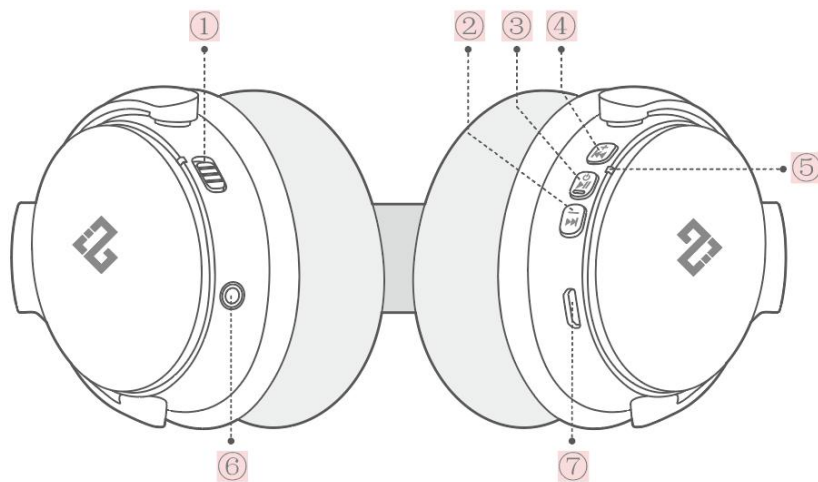

3



5

## Product overview





1. ANC Switch 
2. Previous track/Volume up  
3. Next track/Volume down  
4. Power Switch/Play/Pause/Answer/End a call  
5. LED Indicator Light 
6. AUX Interface 
7. USB-C Charge Interface 

# Charging

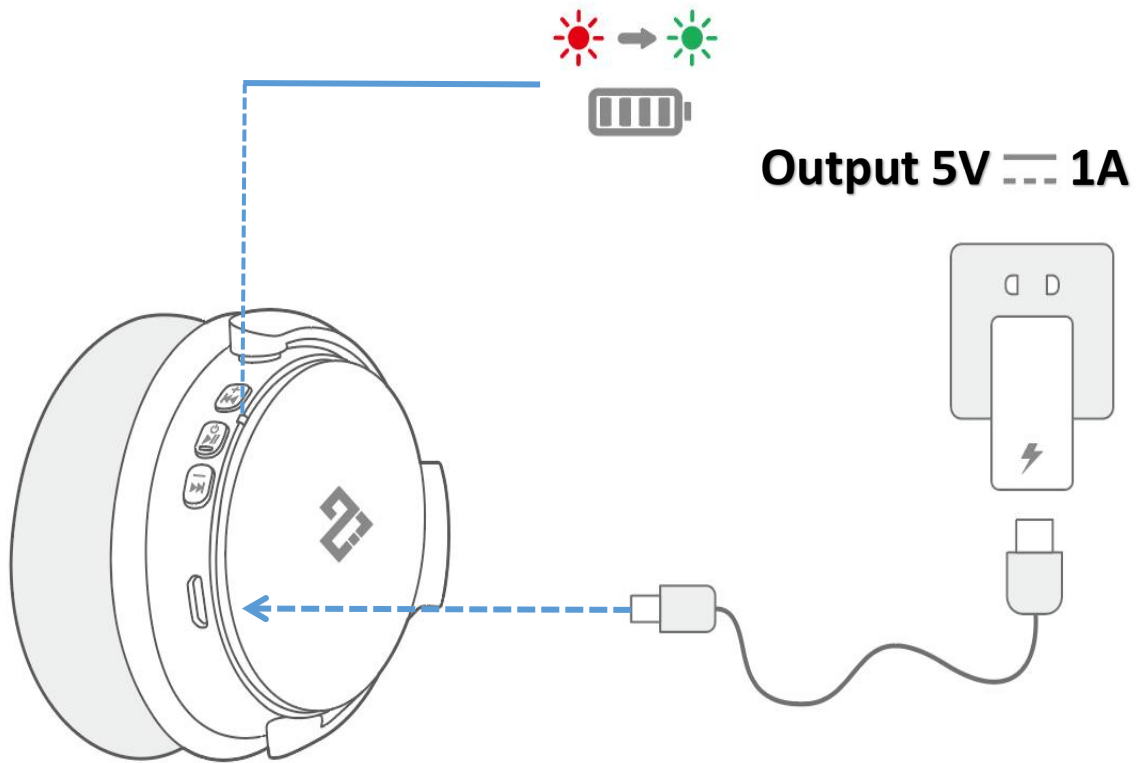
- Fully dry off the USB-C port before charging.
- Use a certified USB-C charging cable and charger to prevent any damage.
- Do not power on your headphone while charging.



	Voice reminder for low power	Low power
	Steady red	Being charged
	Steady green	Fully charged

# Powering on/off

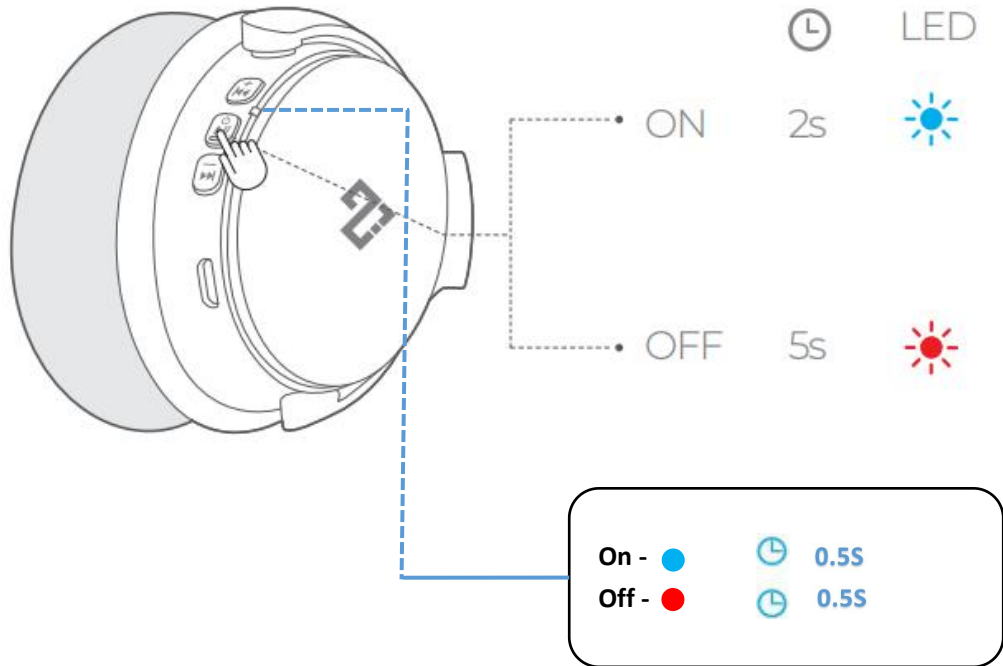

Power on: Press and hold power button for 2 seconds you will hear the voice "Power on"

Power off: Press and hold power button for 5 seconds you will hear the voice "Power off"



<span style="color: blue;">■</span>	Steady blue (for 0.5 second)	Power on
<span style="color: red;">■</span>	Steady red (for 0.5 second)	Power off

# Bluetooth pairing

**Step1** – When powered off, press and hold the power button for 5 seconds until the LED flashing red/blue to enter the Bluetooth pairing mode.

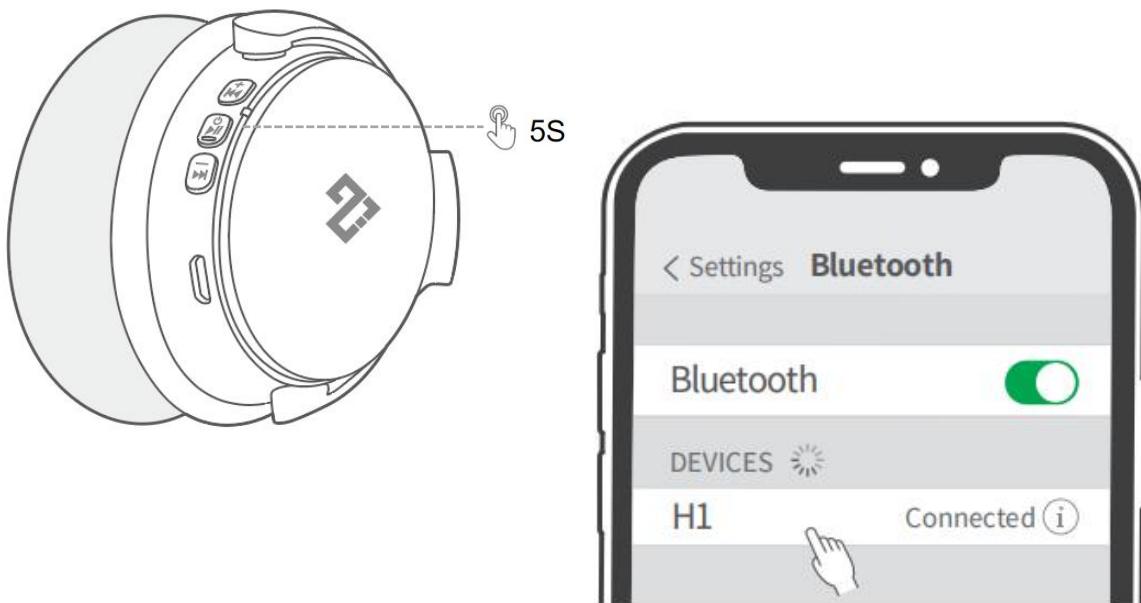
**Step2** – Select “H1” on your device’ s Bluetooth list to connect



	Flashing blue/red	Bluetooth pairing
	Steady blue (for 2 seconds)	Bluetooth connected

- Each time you power on your headphone, it will automatically connect to your last successfully connected device if available within the Bluetooth range.

# Pairing with another device

Your headphone can be connected to two devices at a time.

Step1:



Step2:

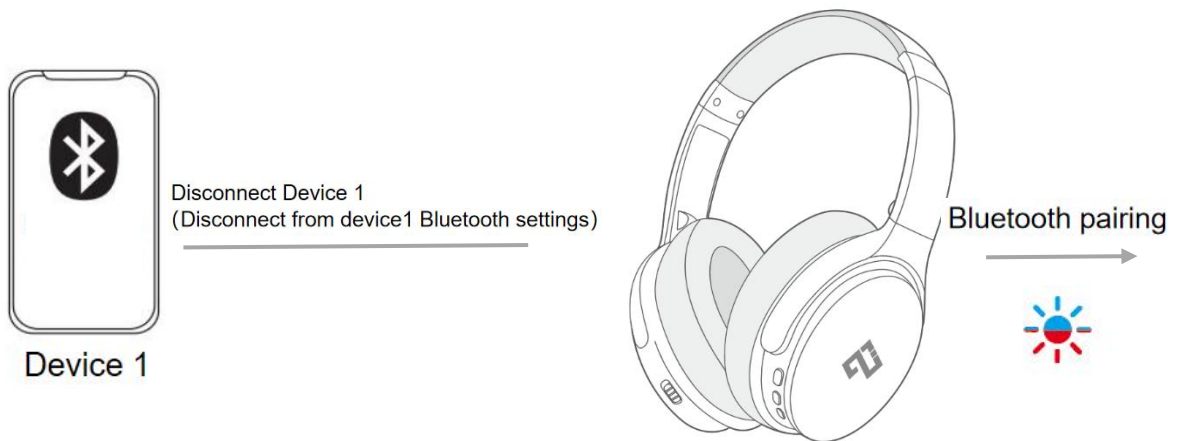

Step3:

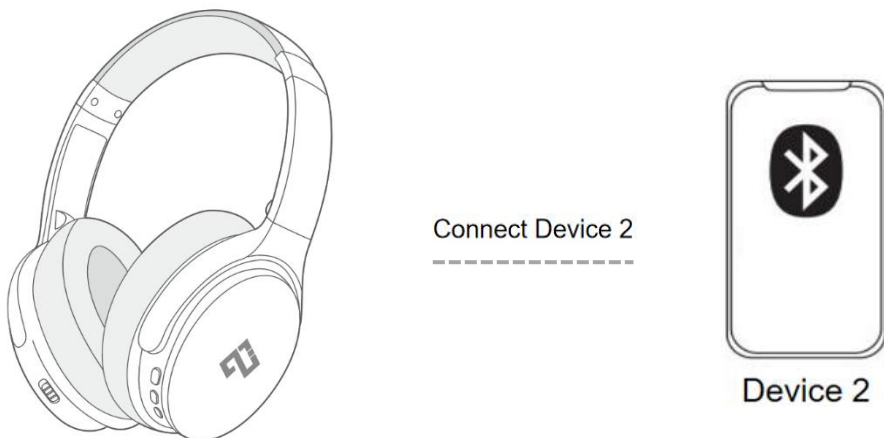

Step4:



Device 1

Open device1 Bluetooth settings  
select H1 to Connect



- Your headphone can only play music on one mobile device at a time. To play from another connected device, pause the currently active device first.

## Active Noise Cancellation

Push the ANC button to the other side to turn on Active Noise Cancellation

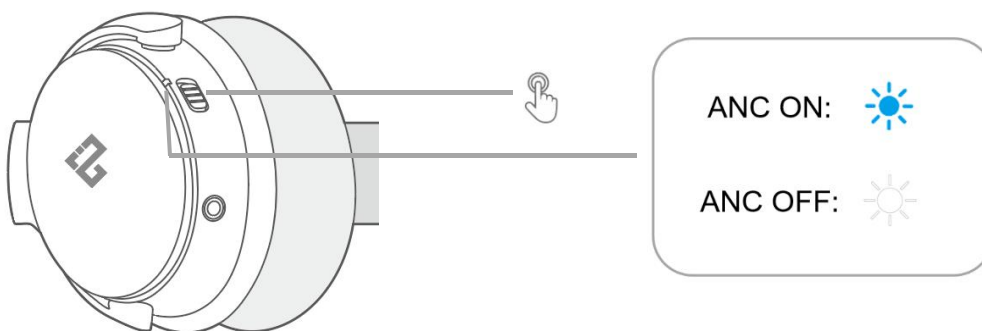

ANC: Blocks most **low frequency** noise (For example, the engine sounds of airplanes and cars, and a few background sounds of offices)



## Aux mode

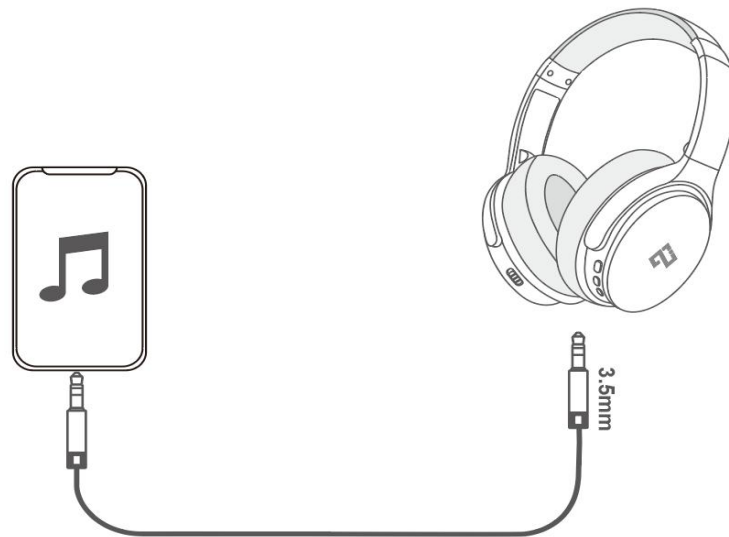

Enjoy music on other devices by plugging in a 3.5mm audio cable  
caution:

1. Using a 3.5mm audio cable will automatically turn off Bluetooth
2. Only the ANC function can be used normally

## Reset

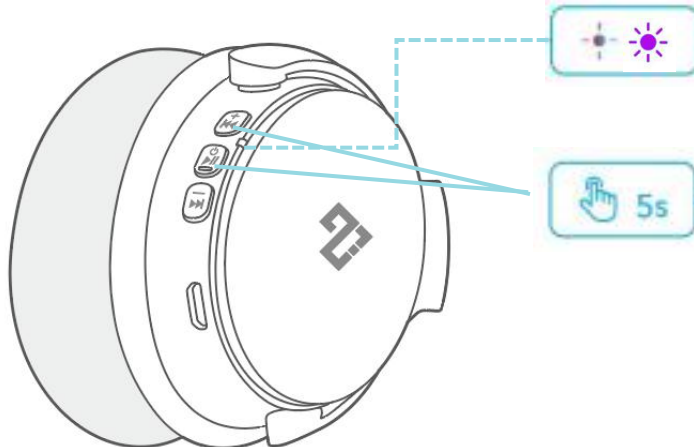

If you experience any connectivity issues or functional issues, you may need to reset the headphone.

- **Step1**—Keep the headset turned on
- **Step2**—Long press the power button + volume up button for 5 seconds, Purple light flashes twice
- **Step3**—The headset is turned off and reset
- **Step4**—Press and hold the power button for 5 seconds, the red and blue lights flash alternately to enter pairing mode

## Calling mode

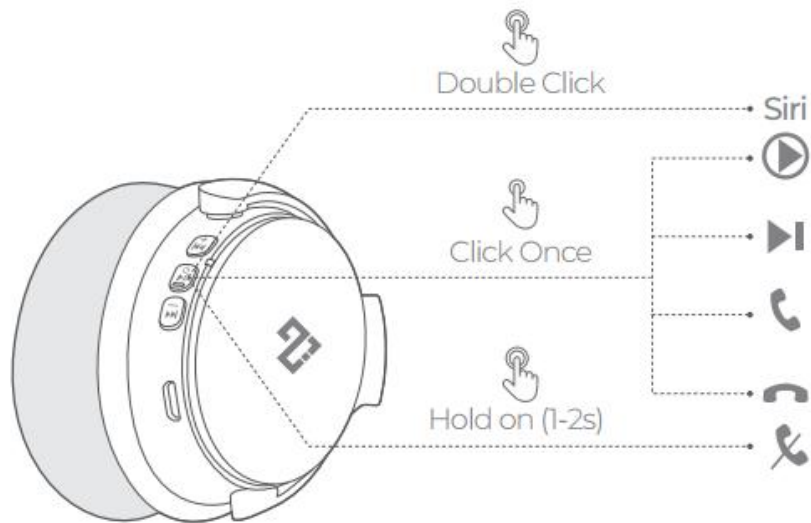

1. Siri and Other voice assistants ————— **Double Click**
2. Answer/Hang up a call ————— **Short press the power button once**
3. Reject a Call ————— **Long press the power button 2s**

## Warranty regulations

Start with your purchase of our products, we promise that the headphone has a one-year warranty service. Whether you have any questions about the product or any problems with the product, we will try our best to provide the solution for you.

Please feel free to contact us and we will reply within 24 hours!

The following two ways:

**1.Customer Service Email:**

**[infuture.customer.service@gmail.com](mailto:infuture.customer.service@gmail.com)**

**2.Amazon Official Mail**

## Packliste



1



2

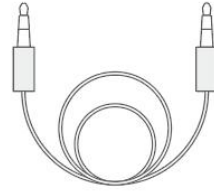

4

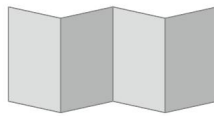

3

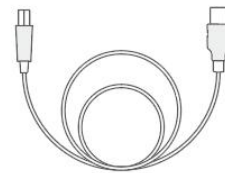

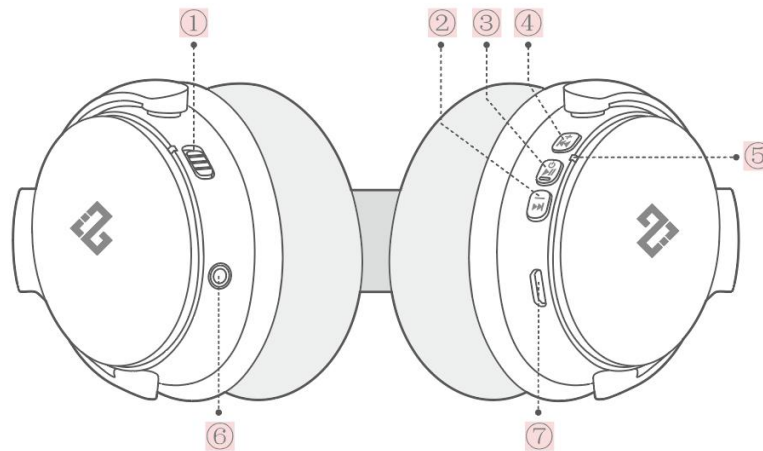

5

## Produktübersicht



8. ANC-Schalter 

9. Vorheriger Titel/Lautstärke erhöhen 

10. Nächster Titel/Lautstärke runter 

11. Netzschalter/Wiedergabe/Pause/Annahme/Beenden eines Anrufs 

12. LED-Anzeigeleuchte 



13. AUX-Schnittstelle 

14. USB-C-Ladeschnittstelle 

## Ladevorgang

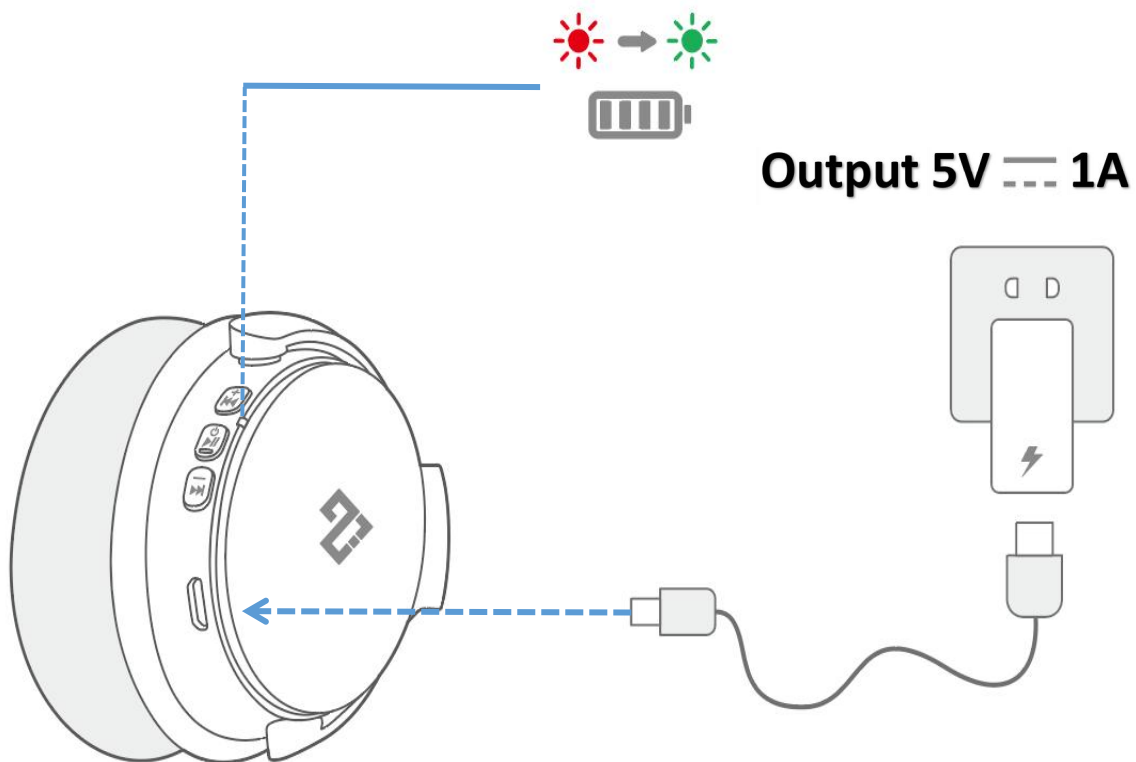
- Trocknen Sie den USB-C-Anschluss vor dem Aufladen vollständig ab.
- Verwenden Sie ein zertifiziertes USB-C-Ladekabel und Ladegerät, um Schäden zu vermeiden.
- Schalten Sie den Kopfhörer während des Ladevorgangs nicht ein.



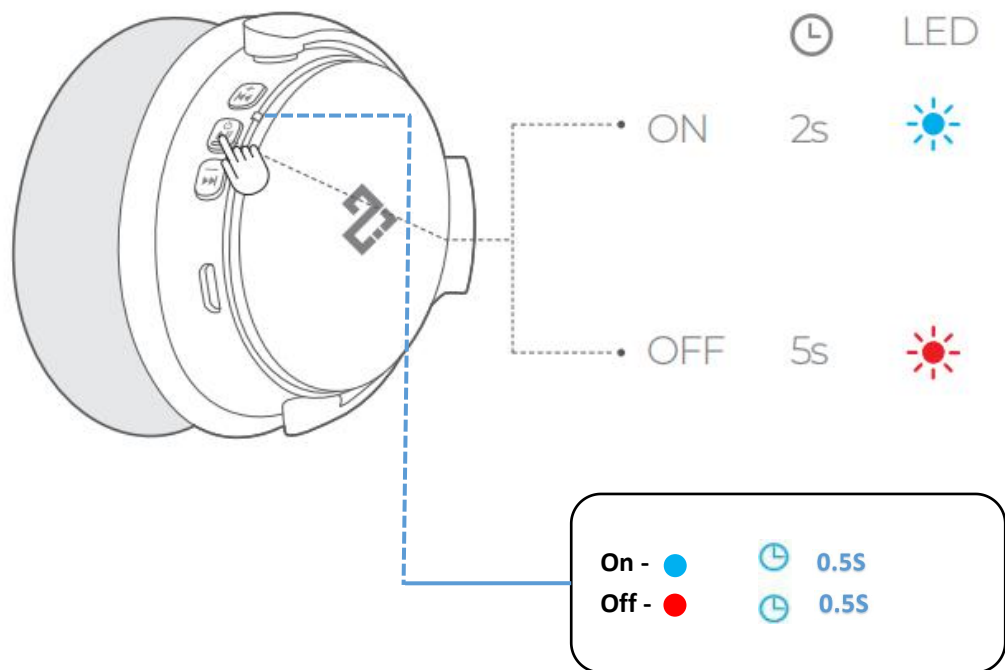

	Spracherinnerung bei niedrigem Stromverbrauch	Low power
	Anhaltendes Rot	Wird aufgeladen
	Anhaltendes Blau	Vollständig aufgeladen

## Ein-/Ausschalten



Einschalten: Halten Sie die Einschalttaste 2 Sekunden lang gedrückt und Sie hören die Stimme "Power on".

Ausschalten: Halten Sie die Einschalttaste 5 Sekunden lang gedrückt, dann hören Sie die Stimme "Power off".



	Konstant blau (für 0.5 Sekunde)	Eingeschaltet
	Konstant rot (für 0.5 Sekunde)	Ausgeschaltet

# Bluetooth-Kopplung

**Schritt 1** – Halten Sie im ausgeschalteten Zustand die Einschalttaste 5 Sekunden lang gedrückt, bis die LED rot/blau blinkt, um den Bluetooth-Kopplungsmodus zu aktivieren.

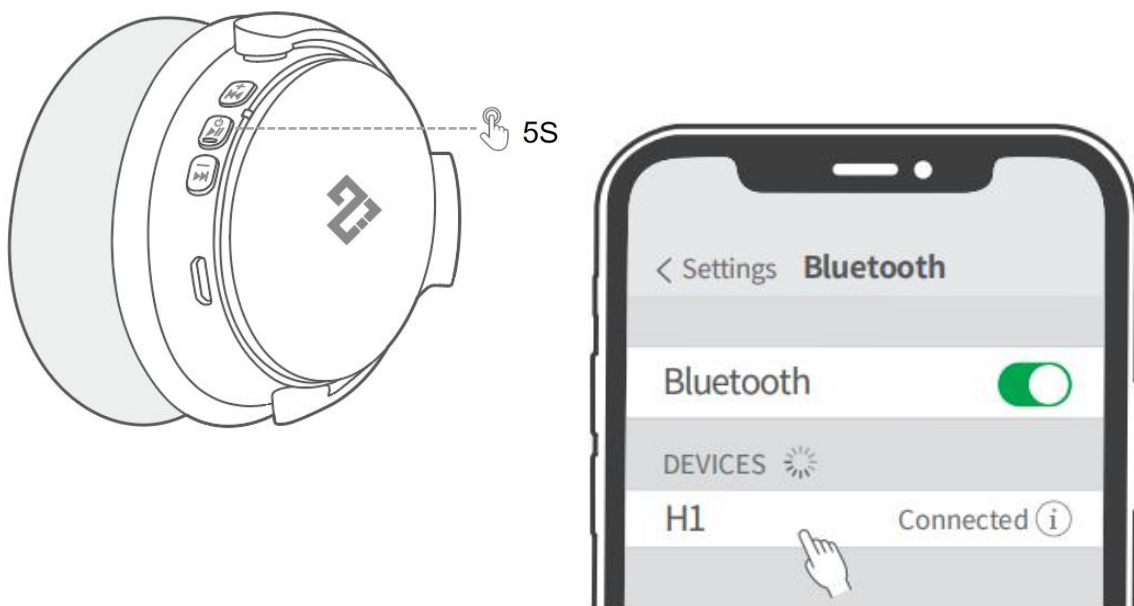
**Schritt 2** – Wählen Sie "H1" in der Bluetooth-Liste Ihres Geräts, um eine Verbindung herzustellen.



	Blinkt Rot und blau	Bluetooth-Kopplung
	Konstant blau (für 2 Sekunden)	Bluetooth verbunden

- Jedes Mal, wenn Sie Ihren infuture-Kopfhörer einschalten, stellt er automatisch eine Verbindung zum zuletzt erfolgreich verbundenen Gerät her, sofern dieses innerhalb der Bluetooth-Reichweite verfügbar ist.

# Kopplung mit einem anderen Gerät

Ihr Kopfhörer kann mit zwei Geräten gleichzeitig verbunden werden.

Schritt 1:



Schritt 2:



Schritt 3:

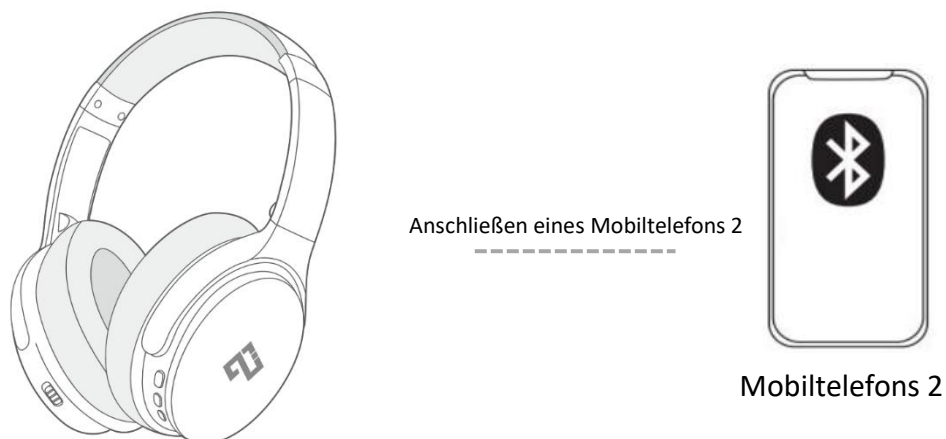



Schritt 4:



Ihr Kopfhörer kann nur auf einem mobilen Gerät gleichzeitig Musik abspielen. Um Musik von einem anderen angeschlossenen Gerät wiederzugeben, halten Sie zunächst das derzeit aktive Gerät an.

## Aktive Geräuschunterdrückung

Drücken Sie den Knopf auf die andere Seite, um die aktive Geräuschunterdrückung zu aktivieren.

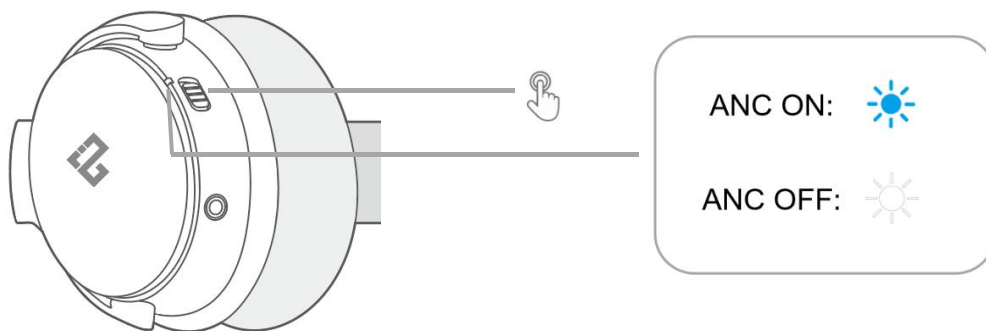

ANC: Blockiert die meisten tieffrequenten Geräusche (Zum Beispiel die Motorengeräusche von Flugzeugen und Autos sowie einige Hintergrundgeräusche von Büros)

## AUX-Modus

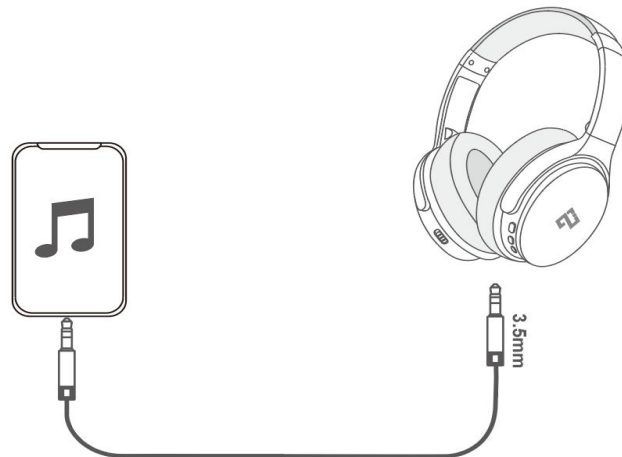

Genießen Sie Musik auf anderen Geräten, indem Sie ein 3,5-mm-Audiokabel anschließen

Vorsicht:

1. Bei Verwendung eines 3,5-mm-Audiokabels wird Bluetooth automatisch deaktiviert.
2. Nur die ANC-Funktion kann normal verwendet werden.

## Zurücksetzen

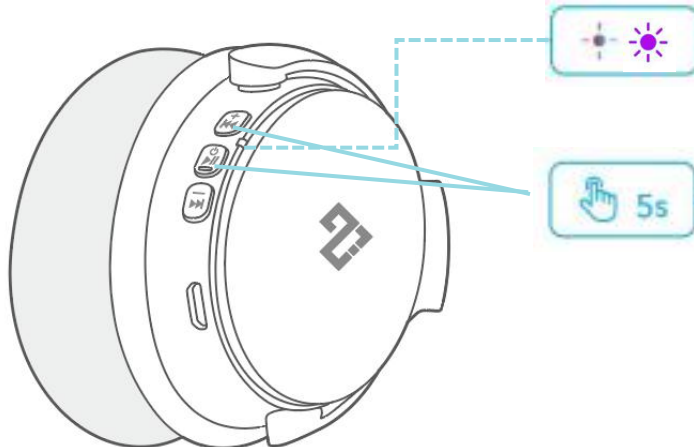

Falls Verbindungs- oder Funktionsprobleme auftreten, müssen Sie die Kopfhörer möglicherweise zurücksetzen.

- **Schritt 1**–Halten Sie das Headset eingeschaltet
- **Schritt 2**–Drücken Sie lange die Power-Taste + Lautstärketaste für 5 Sekunden, lila Licht blinkt zweimal
- **Schritt 3**–Das Headset wird ausgeschaltet und zurückgesetzt
- **Schritt 4**–Halten Sie die Einschalttaste 5 Sekunden lang gedrückt, die roten und blauen Lichter blinken abwechselnd, um den Kopplungsmodus zu aktivieren.

# Telefonfunktionen

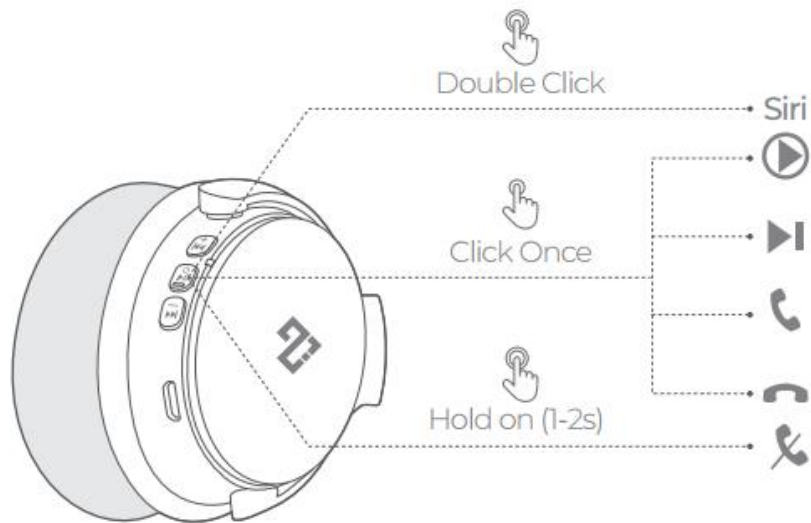

1. Siri und andere Sprachassistenten ----- **Doppelklick**
2. einen Anruf annehmen/auflegen ----- **Drücken Sie einmal kurz die Einschalttaste**
3. Ablehnen eines Anrufs ----- **Langes Drücken der Einschalttaste 2s**

## Gewährleistungen

Beginnen Sie mit dem Kauf unserer Produkte, wir versprechen, dass der Kopfhörer eine einjährige Garantie hat. Ob Sie irgendwelche Fragen über das Produkt oder irgendwelche Probleme mit dem Produkt haben, werden wir unser Bestes versuchen, die Lösung für Sie zu bieten.

Bitte zögern Sie nicht, uns zu kontaktieren und wir werden innerhalb von 24 Stunden antworten!

Die folgenden zwei Möglichkeiten:

**1.Kundenservice E-Mail:**

**[infuture.customer.service@gmail.com](mailto:infuture.customer.service@gmail.com)**

**2.Amazon Offizielle Mail**

## Lista di imballaggio



1



2



4

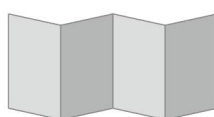

3

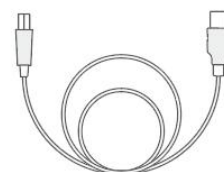

5

## Panoramica del prodotto

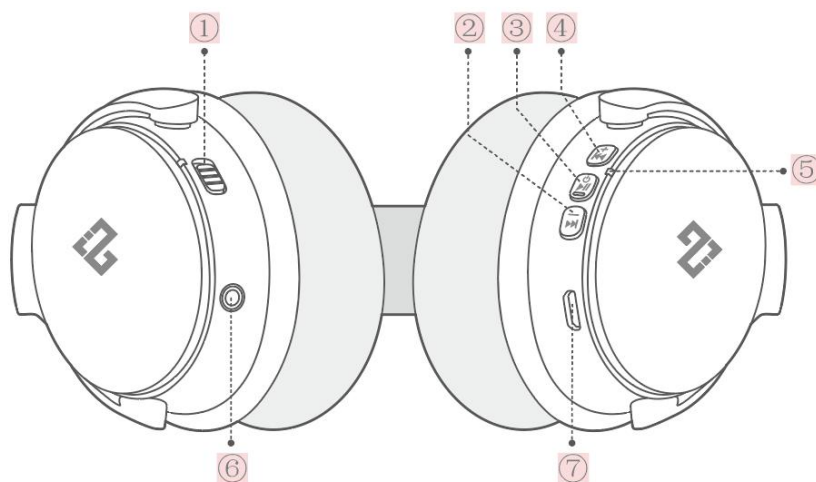

15. Interruttore ANC



16. Traccia precedente/Volume su



17. Traccia successiva/Volume giù



18. Interruttore di accensione/Play/Pausa/Rispondi/ Termina una chiamata



19. Indicatore luminoso a LED



20. Interfaccia AUX



21. Interfaccia di ricarica USB-C



## In carica

- Asciugare completamente la porta USB-C prima di caricarla.
- Utilizzare un cavo di ricarica USB-C certificato e un caricatore per evitare qualsiasi danno.
- Non accendere le cuffie durante la ricarica.

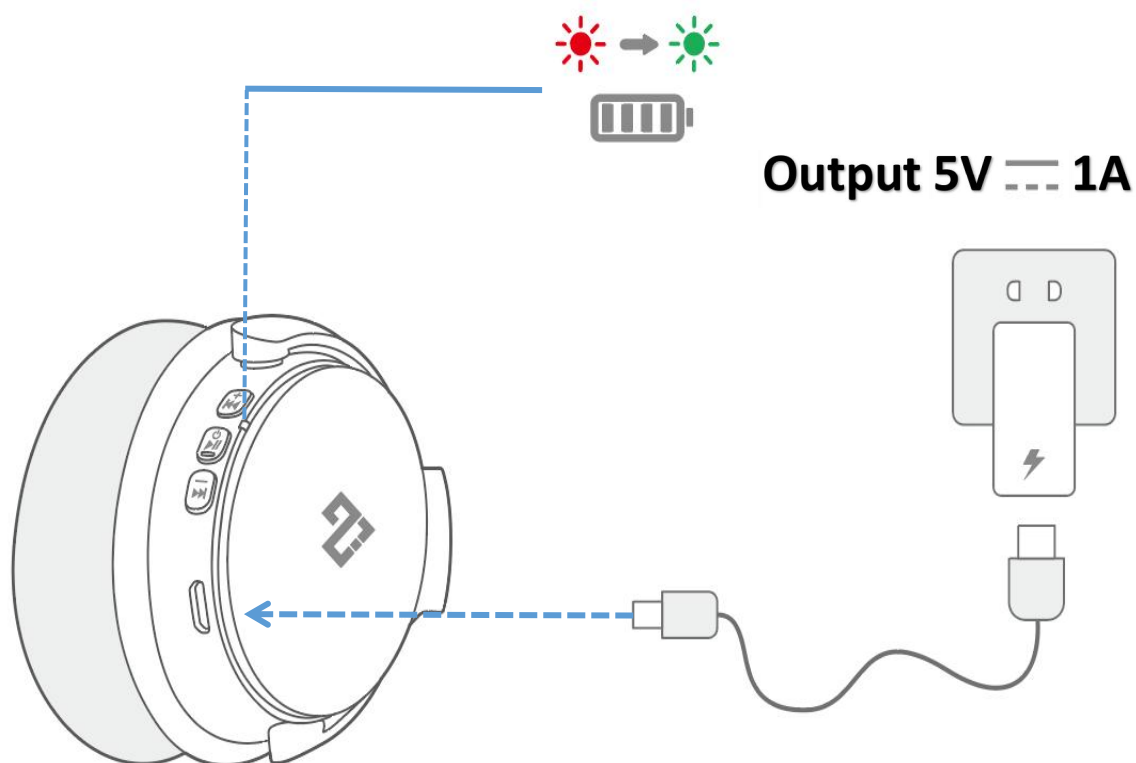

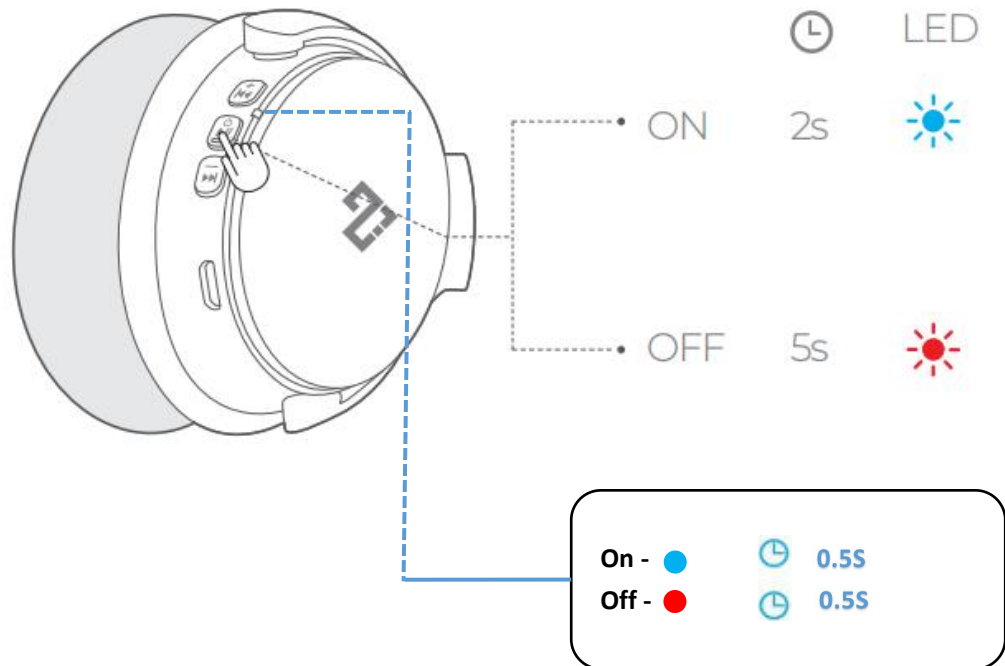

	Promemoria vocale per bassa potenza	Low power
■	Rosso fisso	Essere addebitati
■	Verde fisso	Pienamente carico

## Accensione/spengimento



Accensione: Premere e tenere premuto il pulsante di accensione per 2 secondi, si sentirà la voce "Power on".

Spegnimento: Premere e tenere premuto il pulsante di accensione per 5 secondi, si sentirà la voce "Power off".



	Blu fisso (per 0.5 secondo)	Acceso
	Rosso fisso (per 0.5 secondo)	Spento

## Associazione Bluetooth

**Step1** - Quando è spento, tenere premuto il pulsante di accensione per 5 secondi fino a quando il LED lampeggia rosso/blu per entrare nella modalità di accoppiamento Bluetooth.

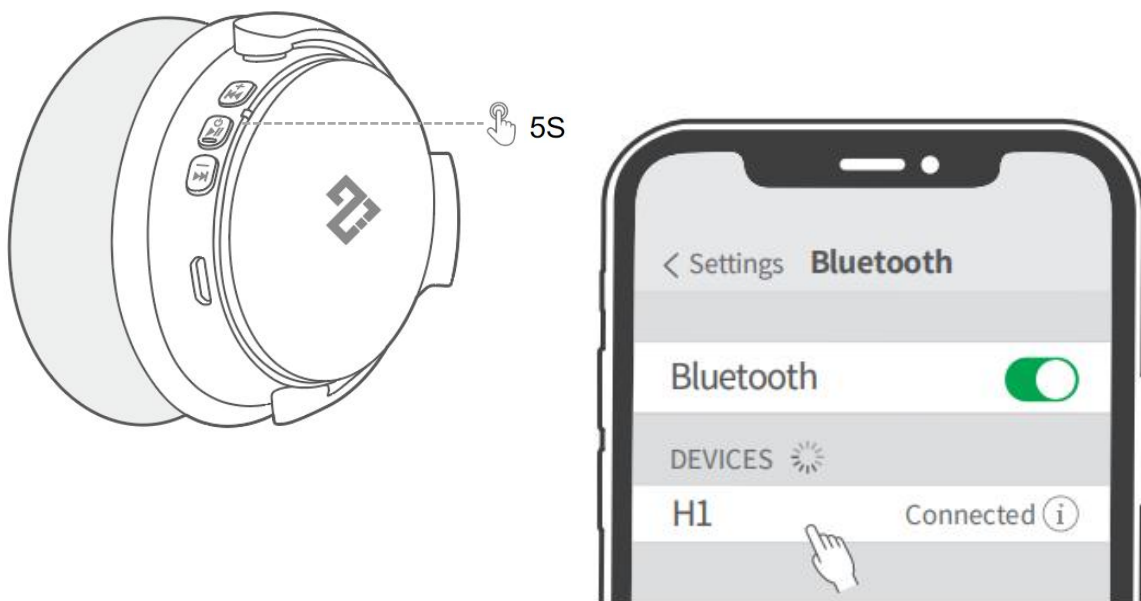
**Step2** - Selezioni "H1" nell'elenco Bluetooth del suo dispositivo per connettersi



	Rosso/Blu lampeggiante	Associazione Bluetooth
	Blu fisso (per 2 secondi)	Connessione al Bluetooth stabilita

- Ogni volta che si accende la cuffia, essa si connetterà all'ultimo dispositivo connesso con successo, se disponibile all'interno della gamma Bluetooth.



# Associazione con un altro dispositivo

Le tue cuffie possono essere collegate a due dispositivi contemporaneamente.

Step1:



Step2:



Step3:



Step4:



Device 1

Aprire le impostazioni Bluetooth del dispositivo 1 e selezionare H1 su Connessioni



- Le tue cuffie possono riprodurre musica solo da un dispositivo mobile alla volta. Per riprodurre da un altro dispositivo collegato, metti prima in pausa il dispositivo attualmente attivo.

## Cancelazione attiva del rumore

- Premi il pulsante ANC nell'altro senso per attivare o disattivare la cancellazione attiva del rumore.

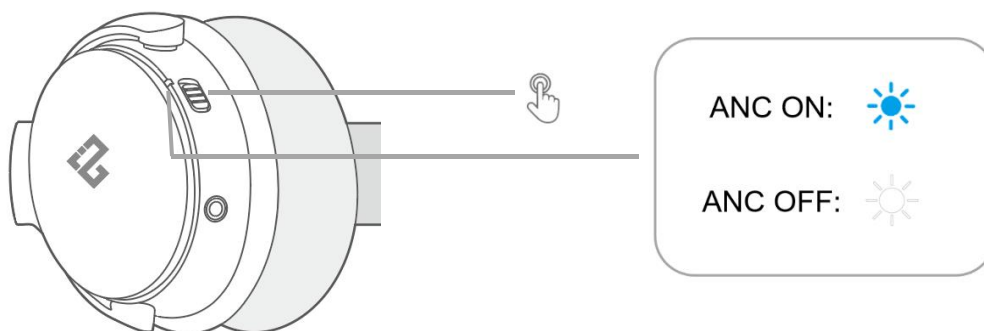

ANC: Blocca la maggior parte dei rumori a bassa frequenza (per esempio, i suoni del motore di aerei e auto, e alcuni suoni di fondo degli uffici)

## Modalità AUX

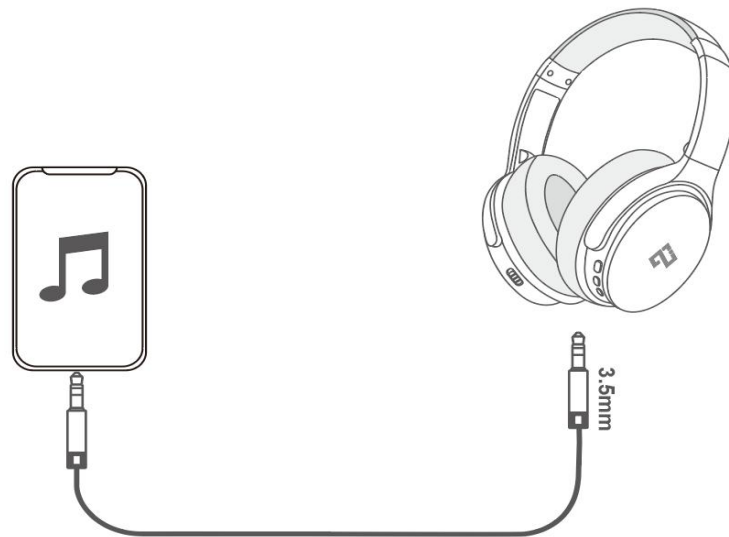

**Goditi la musica su altri dispositivi collegando un cavo audio da 3,5 mm**

Cautela:

1. L'uso di un cavo audio da 3,5 mm spegnerà automaticamente il Bluetooth
2. Solo la funzione ANC può essere usata normalmente

## Visszaállítás

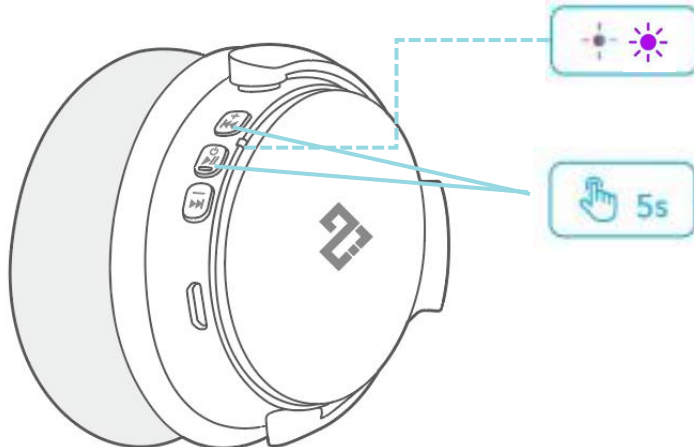

Se si verificano problemi di connettività o di funzionamento, potrebbe essere necessario resettare le cuffie.

Step1-Tenere l'auricolare acceso

Step2-Premere a lungo il pulsante di accensione + il pulsante del volume su per 5 secondi, la luce viola lampeggia due volte

Step3-L'auricolare è spento e resettato

Step4-Tenere premuto il pulsante di accensione per 5 secondi, le luci rossa e blu lampeggiano alternativamente per entrare in modalità di accoppiamento

## Modalità di chiamata

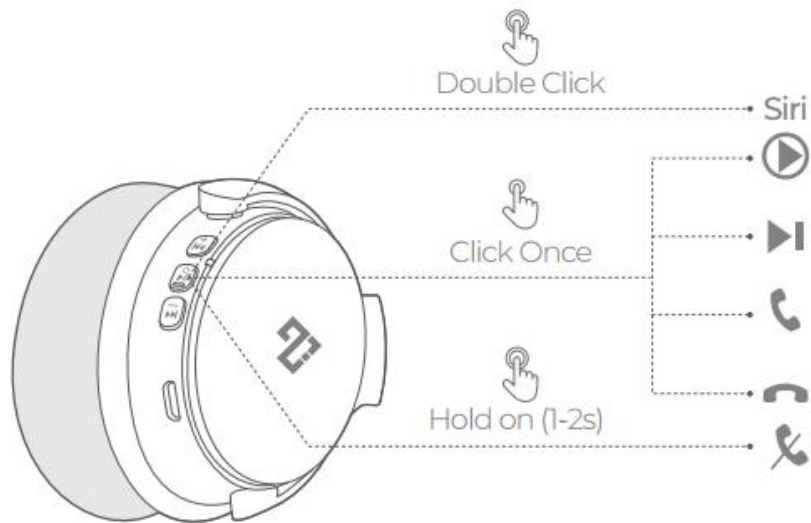

1. Siri e altri assistenti vocali ----- **Doppio clic**
2. Rispondere/agganciare una chiamata ----- **Premere brevemente il pulsante di accensione una volta**
3. Rifiuta una chiamata ----- **Premere a lungo il pulsante di accensione 2s**

## Politica di garanzia

Inizia con l'acquisto dei nostri prodotti, promettiamo che la cuffia ha un servizio di garanzia di un anno. Se avete domande sul prodotto o qualsiasi problema con il prodotto, faremo del nostro meglio per fornire la soluzione per voi.

Non esitate a contattarci e vi risponderemo entro 24 ore!

I seguenti due modi:

**1.Servizio Clienti Email:**

**[infuture.customer.service@gmail.com](mailto:infuture.customer.service@gmail.com)**

**2.Amazon posta ufficiale**

## Liste d'emballage



1



2

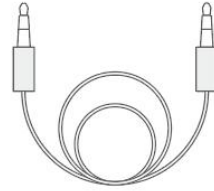

4

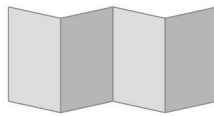

3

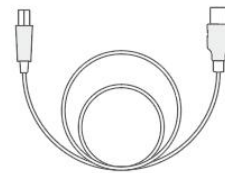

5

## Aperçu du produit

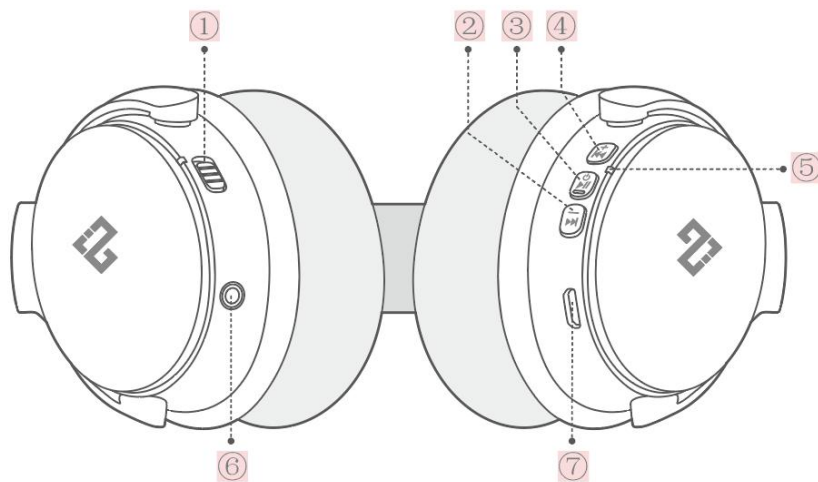



- 22. Interrupteur ANC 
- 23. Piste précédente/Volume élevé  
- 24. Piste suivante/volume en baisse  
- 25. Interrupteur d'alimentation/Lecture/Pause/Réponse/Fin d'appel  
- 26. Indicateur lumineux LED 
- 27. Interface AUX 
- 28. Interface de charge USB-C 

## Chargement

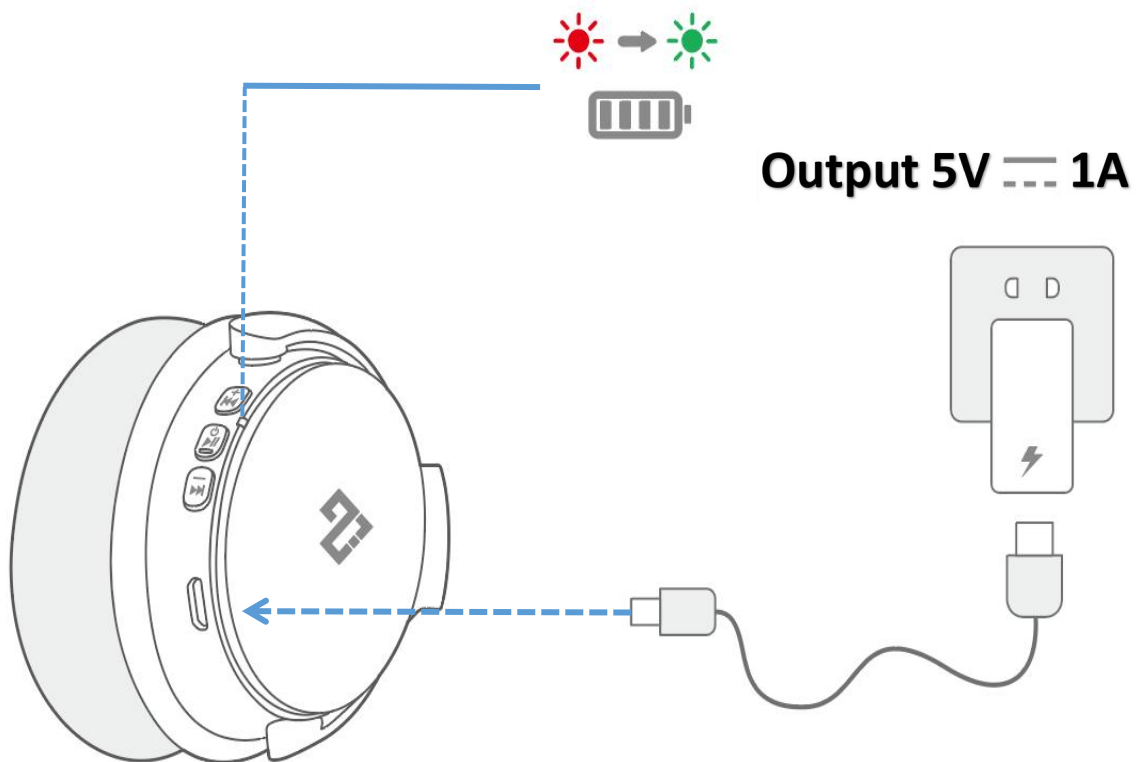
- Séchez entièrement les écouteurs et le port USB avant la charge.
- Utilisez un câble et un chargeur USB-C certifiés pour éviter tout dommage.
- N'allumez pas votre casque pendant le chargement.



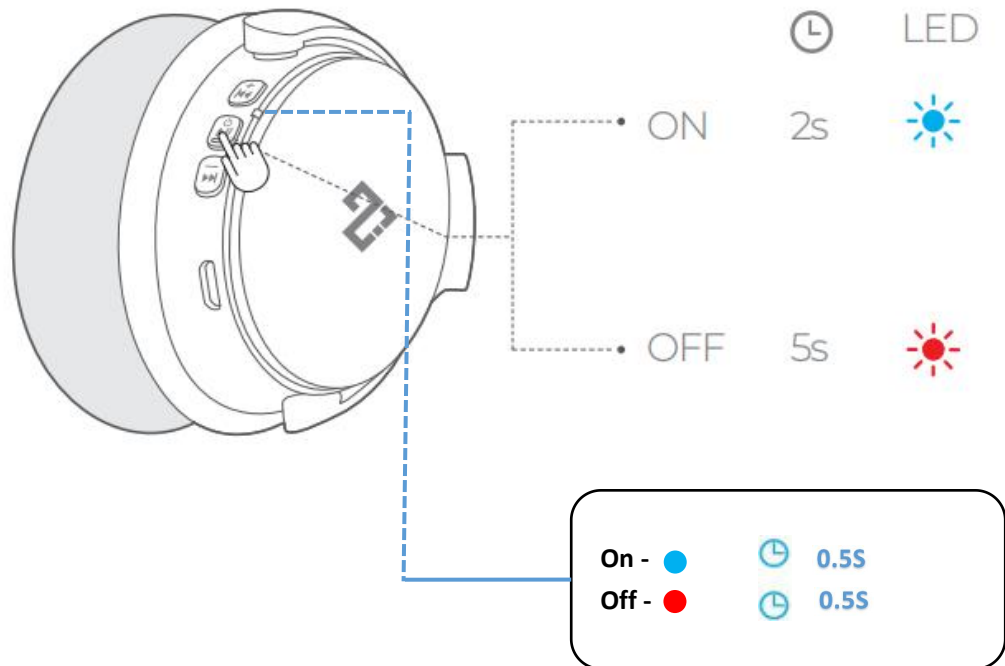

	Rappel vocal en cas de faible puissance	Low power
	Rouge fixe	Being charged
	Vert fixe	Fully charged

## Mise sous/hors tension



Mise en marche : Appuyez et maintenez le bouton d'alimentation pendant 2 secondes, vous entendrez la voix "Power on".

Mise hors tension : Appuyez et maintenez le bouton d'alimentation pendant 5 secondes, vous entendrez la voix "Power off".

	Bleu fixe (pendant 0.5 seconde)	Power on
	Rouge fixe (pendant 0.5 seconde)	Power off





## Couplage Bluetooth

**Step1** – Lorsque l'appareil est éteint, appuyez sur le bouton d'alimentation et maintenez-le enfoncé pendant 5 secondes jusqu'à ce que le voyant clignote en rouge/bleu pour passer en mode de couplage Bluetooth.

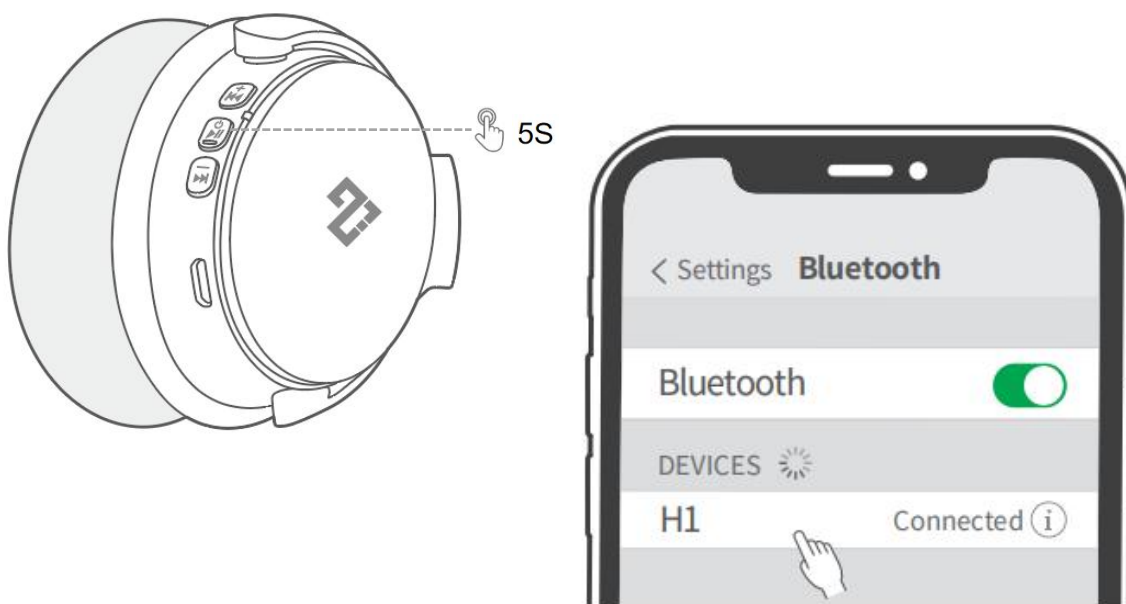
**Step2** – Sélectionnez "H1" dans la liste Bluetooth de votre appareil pour vous connecter.



	Rouge/Bleu clignotant	Couplage Bluetooth
	Bleu fixe (pendant 2 secondes)	Bluetooth connecté

- Each time you power on your headphone, it will automatically connect to your last successfully connected device if available within the Bluetooth range.

# Couplage avec un autre appareil

Votre casque peut être connecté à deux appareils à la fois..

Step1:

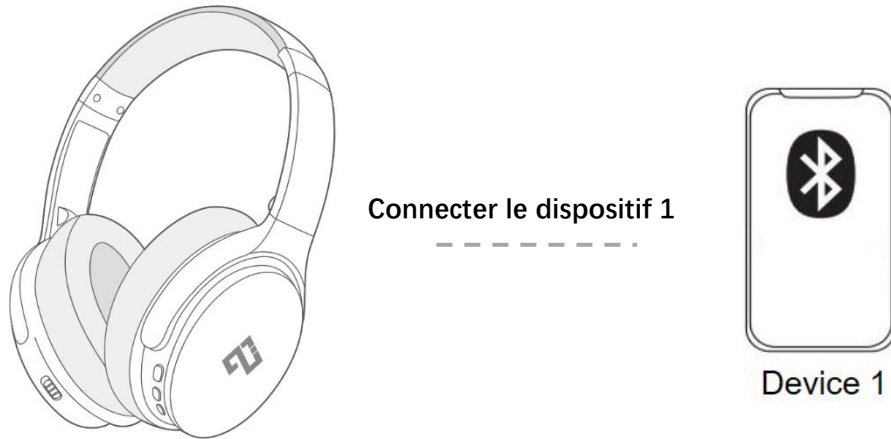

Step2:



Step3:



Step4:



Device 1

Ouvrez les paramètres Bluetooth du périphérique 1, sélectionnez H1 pour Connecter



- Votre casque ne peut lire la musique que sur un seul appareil mobile à la fois. Pour écouter la musique d'un autre appareil connecté, mettez d'abord en pause l'appareil actuellement actif.

## Réduction active du bruit

Appuyez sur le bouton ANC pour activer ou désactiver la fonction d'annulation active du bruit.

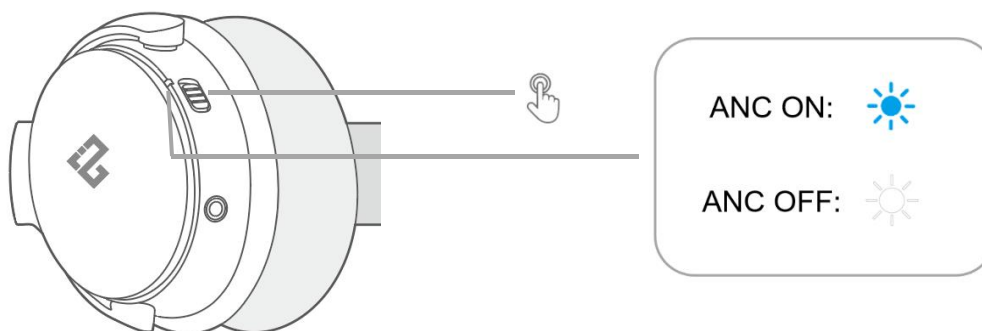

ANC : Bloque la plupart des bruits de **basse fréquence** (Par exemple, les bruits de moteur des avions et des voitures, et quelques bruits de fond des bureaux) .

## Mode AUX

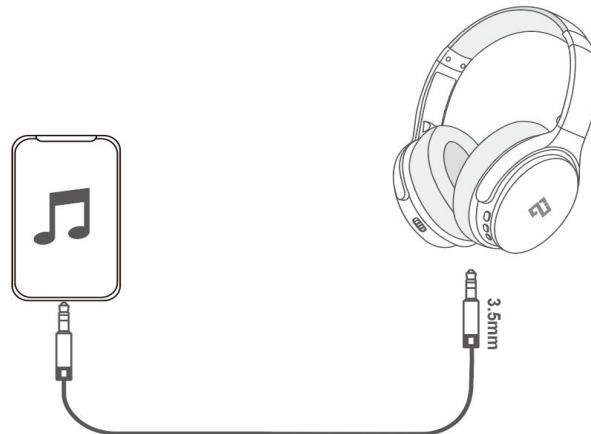

Profitez de la musique sur d'autres appareils en branchant un câble audio de 3,5 mm.  
attention :

1. L'utilisation d'un câble audio de 3,5 mm désactive automatiquement la fonction Bluetooth.
2. Seule la fonction ANC peut être utilisée normalement

## Réinitialisation

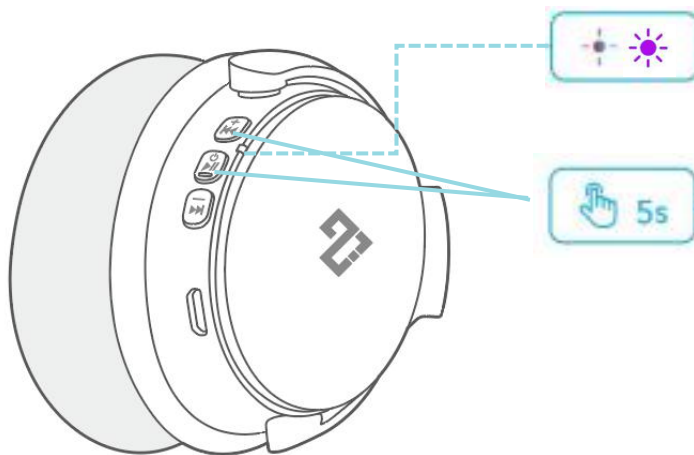

Si vous rencontrez des problèmes de connectivité ou de fonctionnement, vous devrez peut-être réinitialiser le casque.

Étape 1 - Maintenez l'oreillette allumée.

Étape 2 - Appuyez longuement sur le bouton d'alimentation + le bouton d'augmentation du volume pendant 5 secondes, la lumière violette clignote deux fois.

Étape 3 : l'oreillette est éteinte et réinitialisée.

Étape 4 : appuyez sur le bouton d'alimentation et maintenez-le enfoncé pendant 5 secondes, les lumières rouge et bleue clignotent alternativement pour passer en mode d'appairage.

## Mode d'appel

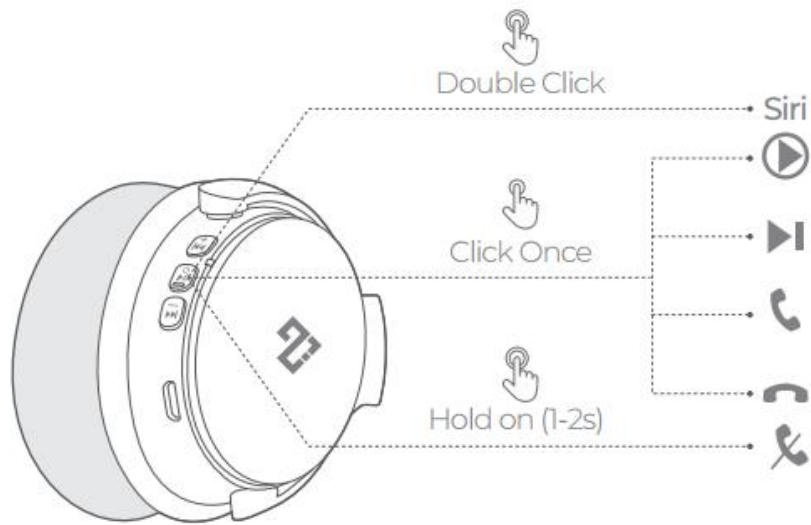

1. Siri et autres assistants vocaux ----- **Double-clic**
2. répondre/raccrocher un appel ----- **Appui court sur le bouton d'alimentation une fois**
3. rejeter un appel ----- **Appui long sur le bouton d'alimentation pendant 2 secondes**

## Politique de garantie

En commençant par l'achat de nos produits, nous vous promettons que le casque dispose d'un service de garantie d'un an. Si vous avez des questions sur le produit ou des problèmes avec le produit, nous ferons de notre mieux pour vous fournir la solution.

N'hésitez pas à nous contacter et nous vous répondrons dans les 24 heures.

Les deux manières suivantes :

**1.Courriel du service clientèle :**

**[infuture.customer.service@gmail.com](mailto:infuture.customer.service@gmail.com)**

**2.Courrier officiel d'Amazon**

## Lista de embalaje



1



2

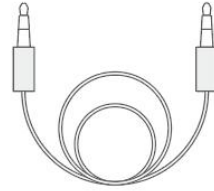

4

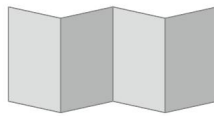

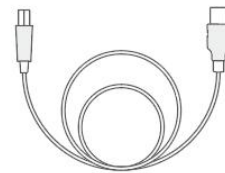

3

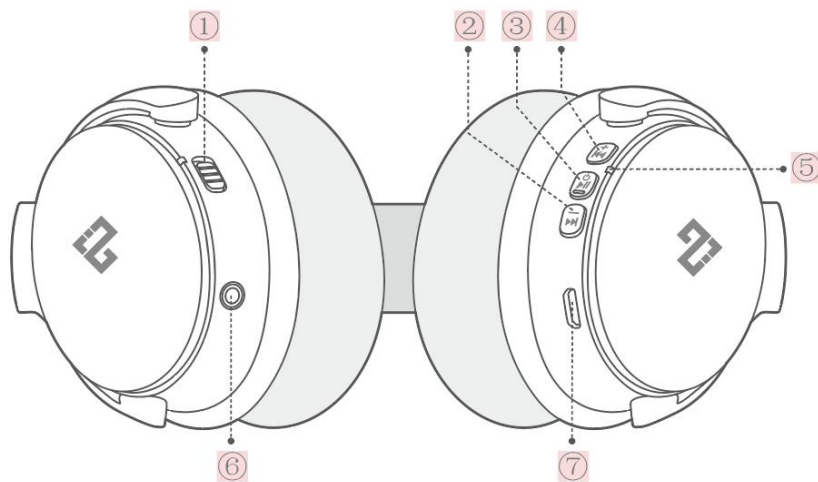

5

## Resumen de productos



- 29. Resumen de productos **ANC**
- 30. Pista anterior/Volumen arriba  
- 31. Pista siguiente/Volumen abajo  
- 32. Interruptor de encendido/Reproducción/Pausa/ Contesta el teléfono / Cuelga el teléfono  
- 33. Luz indicadora LEI 
- 34. Interfaz AUX 
- 35. USB-C Interfaz de carga 

## Carga

- Seca completamente el puerto USB-C antes de cargar los auriculares.
- Utiliza un cable de carga USB-C certificado y un cargador para evitar cualquier daño.
- No enciendas los auriculares mientras se cargan.

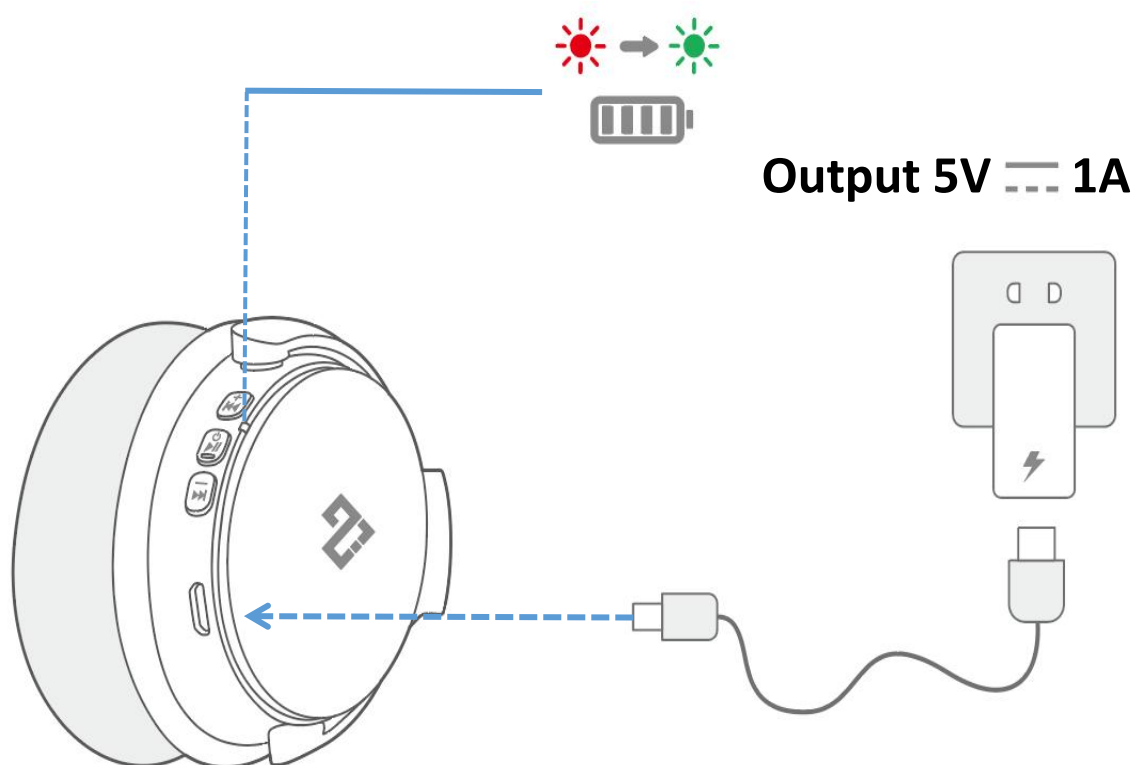

	Recordatorio de voz por baja potencia	Baja potencia
■ Rojo	Rojo	Carga en curso
■ Verde	Verde	Totalmente cargado



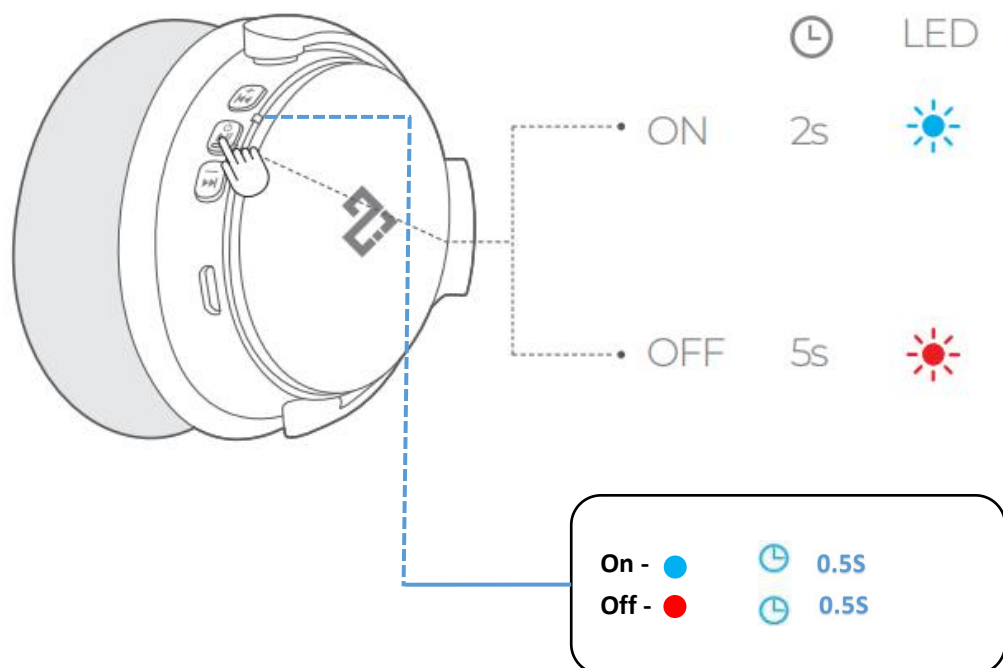

## Encendido y apagado



Encendido: Mantén pulsado el botón de encendido durante 2 segundos y escucharás la voz "Power on".

Apagado: Mantenga pulsado el botón de encendido durante 5 segundos y escuchará la voz "Power off".



	Manténgalo azul (0,5 segundos)	Encendido
	Manténgalo en rojo (0,5 segundos)	Apagado

## Emparejamiento por Bluetooth

**Paso 1** – Cuando esté apagado, mantenga pulsado el botón de encendido durante 5 segundos hasta que el LED parpadee en rojo/azul para entrar en el modo de emparejamiento Bluetooth.

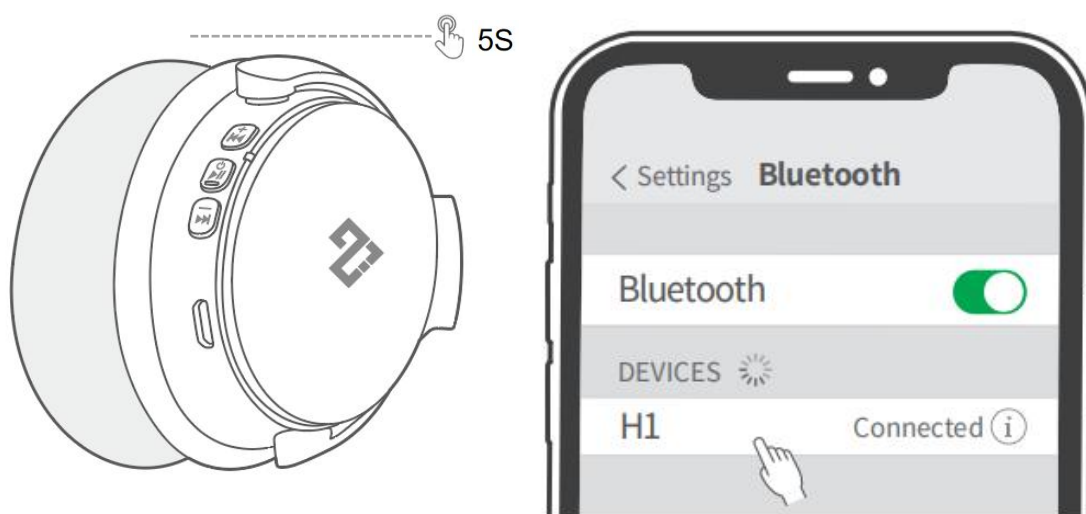
**Paso 2** – Seleccione "H1" en la lista de Bluetooth de su dispositivo para conectarse



	<b>Azul/rojo intermitente</b>	<b>Emparejamiento por Bluetooth</b>
	<b>Manténgalo azul (2 segundos)</b>	<b>Conectado por Bluetooth</b>

- Cada vez que enciendas los auriculares, se conectarán automáticamente a su último dispositivo conectado con éxito si está disponible dentro del rango de Bluetooth.

## Emparejamiento con otro dispositivo

Los auriculares pueden conectarse a dos dispositivos a la vez.

Paso 1:



Paso 2:



Paso3:



Paso4:





Device 1

Abrir la configuración de Bluetooth del dispositivo1  
seleccione H1 para Conectar

---

Los auriculares sólo pueden reproducir música en un dispositivo móvil a la vez. Para reproducir desde otro dispositivo conectado, pon en pausa primero el dispositivo actualmente activo.

## Cancelación activa del ruido

pulse el botón ANC para activar o desactivar la cancelación activa del ruido.

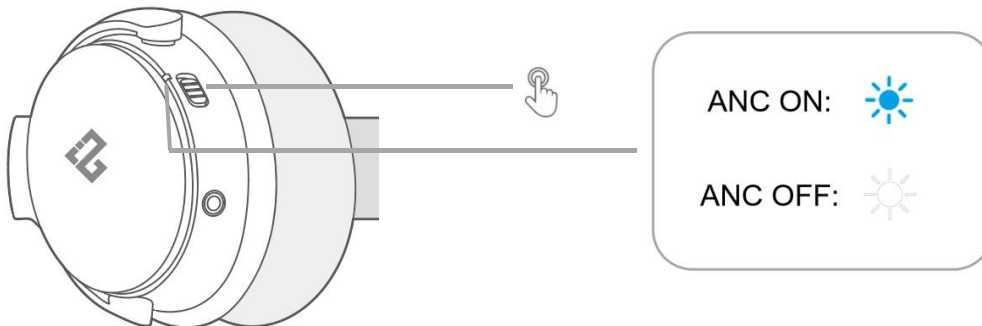

ANC: Bloquea la mayoría de los ruidos de baja frecuencia (Por ejemplo, los sonidos de los motores de los aviones y los coches, y algunos sonidos de fondo de las oficinas)

## Modo Aux

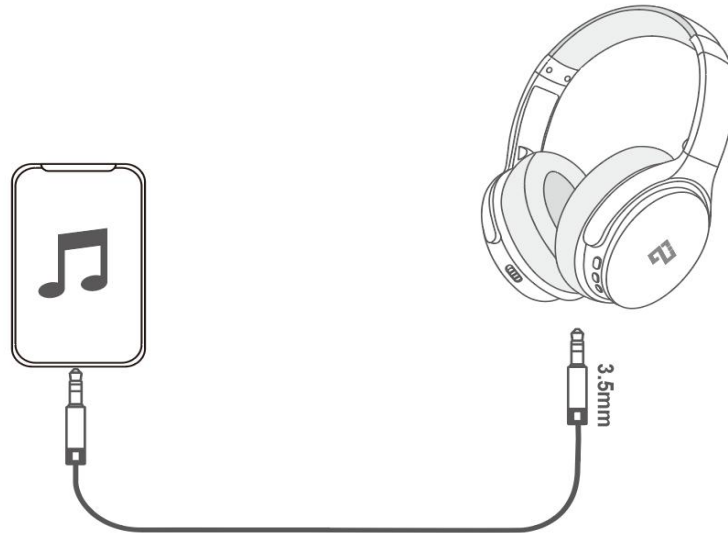

**Disfruta de la música en otros dispositivos conectando un cable de audio de 3,5 mm**

**precaución:**

1. El uso de un cable de audio de 3,5 mm desactivará automáticamente el Bluetooth
2. Sólo se puede utilizar normalmente la función ANC

## Reiniciar

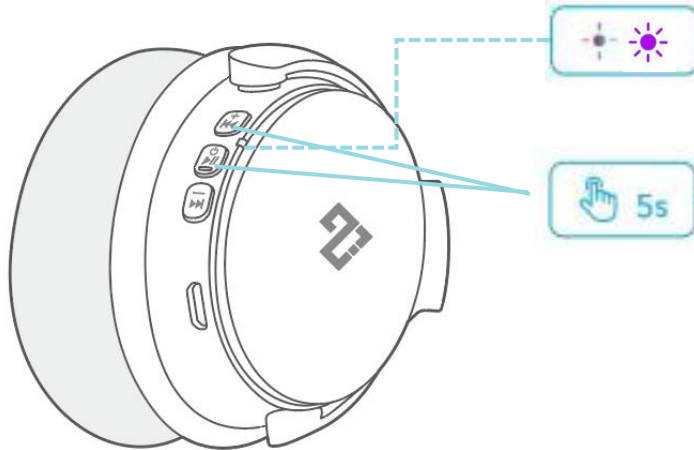

Si tienes problemas de conectividad o de funcionamiento, es posible que tengas que reiniciar los auriculares.

- **Paso 1**–Mantenga los auriculares encendidos
- **Paso 2**–Pulsar prolongadamente el botón de encendido + el botón de subir el volumen durante 5 segundos, la luz púrpura parpadea dos veces
- **Paso 3**–El auricular se apaga y se reinicia
- Step 4**–Press and hold the power button for 5 seconds, the red and blue lights flash alternately to enter pairing mode

## Modo de llamada

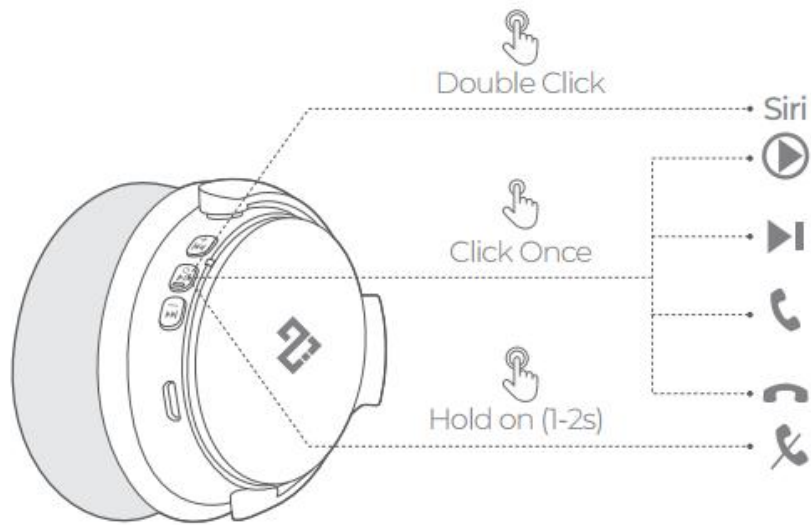

3. Siri y otros asistentes de voz ————— **Doble clic**

4. Contestar/colgar una llamada ————— **Pulse brevemente el botón de encendido una vez**

3. Rechazar una llamada ————— **Pulsar prolongadamente el botón de encendido 2s**

## Política de garantía

Comience con la compra de nuestros productos, le prometemos que el auricular tiene un servicio de garantía de un año. Si usted tiene alguna pregunta sobre el producto o cualquier problema con el producto, vamos a intentar nuestro mejor esfuerzo para proporcionar la solución para usted.

No dude en ponerse en contacto con nosotros y le responderemos en 24 horas!

Las dos formas siguientes:

**1. Correo electrónico del servicio de atención al cliente:**

**[infuture.customer.service@gmail.com](mailto:infuture.customer.service@gmail.com)**

**2. Correo oficial de Amazon**