

# Roborock E4

## Robot Vacuum Cleaner User Manual

Read this user manual carefully before using this product and store it properly for future reference.



# Safety Information

## IMPORTANT SAFETY INSTRUCTIONS

When using an electrical appliance, basic precautions should always be followed, including the following: READ ALL INSTRUCTIONS BEFORE USING (THIS APPLIANCE), Failure to follow the warnings and instructions may result in electric shock, fire and/or serious injury.

### WARNING

- To reduce the risk of fire, electric shock, or injury:
- Do not use outdoors or on wet surfaces.
- Do not allow to be used as a toy. Close attention is necessary when used by or near children, pets or plants.
- Use only as described in this manual. Use only manufacturer's recommended attachments.
- Do not use with damaged cord or plug. If appliance is not working as it should, has been dropped, damaged, left outdoors, or dropped into water, return it to a service center.
- Do not pull or carry by cord, use cord as a handle, close a door on cord, or pull cord around sharp edges or corners.
- Do not run appliance over cord. Keep cord away from heated surfaces.
- Do not unplug by pulling on cord. To unplug, grasp the plug, not the cord.
- Do not handle charger, including charger plug, and charger terminals with wet hands.
- Do not put any object into openings. Do not use with any opening blocked; keep free of dust, lint, hair, and anything that may reduce air flow.
- Keep hair, loose clothing, fingers, and all parts of body away from openings and moving parts.
- Do not use to pick up flammable or combustible liquids, such as gasoline, or use in areas where they may be present.
- Do not pick up anything that is burning or smoking, such as cigarettes, matches, or hot ashes.
- Do not use without dust bag.
- Prevent unintentional starting. Ensure the switch is in the off-position before connecting to battery pack, picking up or carrying the appliance. Carrying the appliance with your finger on the switch or energizing appliance that have the switch on invites accidents.

# Safety Information

- For use only with roborock CDZ14RR or CDZ15RR charger. Recharge only with the charger specified by the manufacturer. A charger that is suitable for one type of battery pack may create a risk of fire when used with another battery pack.
- Use appliances only with specifically designated battery packs. Use of any other battery packs may create a risk of injury and fire.
- Turn off the appliance before making any adjustments, changing accessories, or storing appliance. Such preventive safety measures reduce the risk of starting the appliance accidentally.
- When battery pack is not in use, keep it away from other metal objects, like paper clips, coins, keys, nails, screws or other small metal objects, that can make a connection from one terminal to another. Shorting the battery terminals together may cause burns or a fire.
- Under abusive conditions, liquid may be ejected from the battery; avoid contact. If contact accidentally occurs, flush with water. If liquid contacts eyes, additionally seek medical help. Liquid ejected from the battery may cause irritation or burns.
- Do not use a battery pack or appliance that is damaged or modified. Damaged or modified batteries may exhibit unpredictable behavior resulting in fire, explosion or risk of injury.
- Do not expose a battery pack or appliance to fire or excessive temperature. Exposure to fire or temperature above 130°C may cause explosion.
- Follow all charging instructions and do not charge the battery pack or appliance outside of the temperature range specified in the instructions. Charging improperly or at temperatures outside of the specified range may damage the battery and increase the risk of fire.
- Have servicing performed by a qualified repair person using only identical replacement parts. This will ensure that the safety of the product is maintained.
- Do not modify or attempt to repair the appliance or the battery pack except as indicated in the instructions for use and care.
- Place the cords from other appliances out of the area to be cleaned.
- Do not operate the vacuum in a room where an infant or child is sleeping.
- Do not operate the vacuum in an area where there are lit candles or fragile objects on the floor to be cleaned.

# Safety Information

- Do not operate the vacuum in a room that has lit candles on furniture that the vacuum may accidentally hit or bump into.
- Do not allow children to sit on the vacuum.
- Do not use the vacuum cleaner on a wet surface. Risk Of Injury. Brush May Start Unexpectedly. Disconnect the main Brush Before Cleaning or Servicing.
- Do not use the product when the temperature is higher than 40°C or lower than 4°C, or there is any liquid or sticky substance on the floor.

## SAVE THESE INSTRUCTIONS

Household use only.

## IMPORTANTES MESURES DE S CURIT

L'utilisation d'un appareil électrique demande certaines précautions:

LIRE TOUTES LES INSTRUCTIONS AVANT DE FAIRE FONCTIONNER (CETAPPAREIL), Le non-respect des mises en garde

et des instructions peut causer des chocs électriques, des incendies et/ou des blessures graves.

## AVERTISSEMENT

- Pour réduire les risques d'incendie, de choc électrique ou de blessure:
- Ne pas exposer à la pluie, Ranger à l'intérieur.
- Ne pas permettre aux enfants de jouer avec l'appareil. Une attention particulière est nécessaire lorsque l'appareil est utilisé par des enfants ou à proximité de ces derniers.
- N'utiliser que conformément à cette notice avec les accessoires recommandés par le fabricant.
- Ne pas utiliser si le cordon ou la fiche est endommagé. Retourner l'appareil à un atelier de réparation s'il ne fonctionne pas bien, s'il est tombé ou s'il a été endommagé, oublié à l'extérieur ou immergé.
- Ne pas tirer soulever ni trainer l'appareil par le cordon. Ne pas utiliser le cordon comme une poignée, le coincer dans

# Safety Information

- l'embrasure d'une porte ou l'appuyer contre des arêtes vives ou des coins. Ne pas faire rouler l'appareil sur le cordon.
- Garder le cordon à l'écart des surfaces chaudes. Ne pas débrancher en tyrant sur le cordon. Tirer plutôt la fiche. Ne pas manipuler le chargeur, y compris la prise du chargeur, et les bornes du chargeur avec les mains mouillées.
  - N'insérer aucun objet dans les ouvertures. Ne pas utiliser l'appareil lorsqu'une ouverture est bloquée. S'assurer que de la poussière, de la peluche, des cheveux ou d'autres matières ne réduisent pas le débit d'air. Maintenir les cheveux, les vêtements amples, les doigts et toutes les parties du corps à l'écart des ouvertures et des pièces mobiles.
  - User de prudence lors du nettoyage des escaliers.
  - Ne pas aspirer des liquides inflammables ou combustibles, comme de l'essence, et ne pas faire fonctionner dans des endroits où peuvent se trouver de tels liquides.
  - Ne pas aspirer de matières en combustion ou qui dégagent de la fumée, comme des cigarettes, des allumettes ou des cendres chaudes.
  - Ne pas utiliser l'appareil si le sac à poussière ou le filtre n'est pas en place.
  - Empêcher une mise en marche accidentelle. S'assurer que l'interrupteur est à la position arrêt avant de raccorder la batterie, de lever ou de déplacer l'appareil. Transporter l'appareil en gardant un doigt sur l'interrupteur, ou mettre sous tension un appareil dont l'interrupteur est à la position marche peut causer un accident.
  - Pour emploi seulement avec roborock CDZ14RR or CDZ15RR chargeur. Recharger uniquement avec le chargeur prescrit par le fabricant. Un chargeur convenant à un type de batterie peut présenter un risque d'incendie lorsqu'il est utilisé avec une autre batterie.
  - Retirer la batterie de l'appareil avant d'effectuer des réglages, changer les accessoires ou ranger l'appareil. Ces mesures de sécurité ont pour but d'éviter une mise en marche accidentelle de l'appareil.
  - Lorsque l'appareil n'est pas utilisé, tenir la batterie loin d'objets métalliques comme des trombones, des pièces de monnaie, des clés, des clous, des vis ou autres petits objets qui pourraient établir une liaison entre les bornes. Un court-circuit des bornes des batteries peut causer des brûlures ou un incendie.
  - Utiliser uniquement les batteries recommandées pour l'appareil. L'utilisation d'autres types de batteries peut présenter un risque de blessure ou d'incendie.
  - Lorsque l'appareil n'est pas utilisé, tenir la batterie loin d'objets métalliques comme des trombones, des pièces de monnaie, des clés, des clous, des vis ou autres petits objets qui pourraient établir une liaison entre les bornes. Un

# Safety Information

courtcircuit des

- bornes des batteries peut causer des brûlures ou un incendie.
- En condition d'usage abusif, du liquide peut s'échapper de la batterie ; éviter tout contact avec ce liquide.
- En cas de contact accidentel, rincer abondamment avec de l'eau. En cas de contact avec les yeux, consulter également un médecin. Le liquide projeté peut causer des irritations ou des brûlures.
- Ne pas utiliser une batterie ou un appareil endommagé ou qui a été modifié. Des batteries endommagées ou modifiées peuvent avoir un comportement imprévisible pouvant causer un incendie, une explosion ou un risque de blessure.
- Ne pas exposer une batterie ou un appareil à la flamme ou à des températures excessives. L'exposition à une flamme ou à des températures supérieures à 130 °C peut causer une explosion.
- Respecter toutes les instructions de chargement et ne pas charger la batterie ou l'appareil à des températures qui ne sont pas incluses dans la gamme de températures indiquées dans la notice d'instructions. Un chargement mal effectué.
- Confier les réparations à une personne qualifiée qui utilisera uniquement des pièces de remplacement identiques. Cette façon de faire garantira la sécurité du produit.
- Ne pas modifier ni tenter de réparer l'appareil ou la batterie sauf comme il est indiqué dans les instructions d'utilisation et d'entretien.
- Éloigner les cordons d'autres appareils de la zone à nettoyer.
- Ne pas utiliser l'aspirateur dans une pièce où un nourrisson ou un enfant dort.
- Ne pas utiliser l'aspirateur dans un endroit où il ya des bougies allumées ou des objets fragiles sur le plancher à nettoyer.
- Ne pas utiliser l'aspirateur dans une pièce où il ya des bougies allumées sur les meubles que l'aspirateur peut heurter ou se cogner accidentellement.
- Ne pas laisser les enfants s'asseoir sur l'aspirateur.
- Ne pas utiliser l'aspirateur sur une surface mouillée. Risque de blessures. La brosse motorisée peut se mettre en marche d'une manière imprévue.
- Déconnecter la brosse principale avant le nettoyage ou le service.

# Safety Information

## CONSERVER CES INSTRUCTIONS

Usage Domestique seulement.

### Laser Safety

Class 1 laser product, Complies with FDA 21 CFR 1040.10 and 1040.11 except for conformance with IEC 60825-1 Ed. 3., as described in Laser Notice 56, dated May 8, 2019.

# FCC Statement

Compliance Information	
Product Name	Robotic Vacuum Cleaner with Dock Charger
Produce Model	Robotic Vacuum Cleaner Model: roborock E4 Dock Charger Model: CDZ14RR or CDZ15RR
Compliance Statement	This device complies with part 15 of the FCC Rules. Operation is subject to the following two conditions: (1) This device may not cause harmful interference, and (2) this device must accept any interference received, including interference that may cause undesired operation.
Correspondence of the responsible party in USA	
Company	Roborock Technology Co.
Address	108 West 13th Street, Wilmington, Delaware 19801.
Email	support@roborock.com

## Warning

Any changes or modifications to this unit not expressly approved by the party responsible for compliance could void the user's authority to operate the equipment.

Le présent appareil est conforme aux CNR d'Industrie Canada applicables aux appareils radio exempts de licence. L'exploitation est autorisée aux deux conditions suivantes :

- (1) l'appareil ne doit pas produire de brouillage, et
- (2) l'utilisateur de l'appareil doit accepter tout brouillage radioélectrique subi, même si le brouillage est susceptible d'en compromettre le fonctionnement.



# FCC Statement

Changes or modifications not expressly approved by the party responsible for compliance could void the user's authority to operate the equipment.

This equipment has been tested and found to comply with the limits for a Class B digital device, pursuant to part 15 of the FCC Rules. These limits are designed to provide reasonable protection against harmful interference in a residential installation.

This equipment generates uses and can radiate radio frequency energy and, if not installed and used in accordance with the instructions, may cause harmful interference to radio communications. However, there is no guarantee that interference will not occur in a particular installation. If this equipment does cause harmful interference to radio or television reception, which can be determined by turning the equipment off and on, the user is encouraged to try to correct the interference by one or more of the following measures:

- Reorient or relocate the receiving antenna.
- Increase the separation between the equipment and receiver.
- Connect the equipment into an outlet on a circuit different from that to which the receiver is connected.
- Consult the dealer or an experienced radio/TV technician for help.

## MPE Requirements

To satisfy FCC / IC RF exposure requirements, a separation distance of 20 cm or more should be maintained between the antenna of this device and persons during device operation. To ensure compliance, operations at closer than this distance is not recommended.

L'antenne installée doit être située de façon à ce que la population ne puisse être exposée à une distance de moins de 20 cm.

Installer l'antenne de façon à ce que le personnel ne puisse approcher à 20 cm ou moins de la position centrale de l'antenne.

La FCC des États-Unis stipule que cet appareil doit être en tout temps éloigné d'au moins 20 cm des personnes pendant son fonctionnement.

CAN ICES-3 (B)/NMB-3(B)

# Battery and Charging

- Please keep the dock charger away from heat (such as heating plates).
- Do not wipe or clean the chargers shrapnel with a piece of wet cloth or wet hands.
- Please make sure the cleaner is powered off in shipment and original packaging is advised.
- If left unused for a long period, please store the cleaner in a cool and dry place after having it fully charged and switched off, charge it at least every three months to avoid the battery being over discharged.
- Please do not use the product when the temperature is higher than 40°C or lower than 4°C , or there is any liquid or sticky substance on the floor.

Battery pack charging temperature		4°C ~ 40°C	@Max Charging Current:0.5C
Battery pack using temperature		4°C ~ 40°C	@Max Discharge Current:0.5C
Battery pack storage temperature	Storage(1month)	-20°C ~ 60°C @Less than 70% RH	If the battery pack store at 25°C over the 3 months period, it should be recharged.
	Long Storage(3months)	-20°C ~ 45°C @Less than 70% RH	
	Long Storage(1year)	-20°C ~ 20°C @Less than 70% RH	

# Product introduction

## Robot

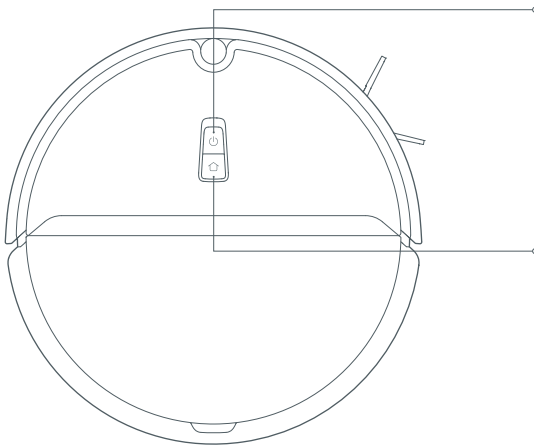

### Clean/Power

- Press to start cleaning
- Press and hold to power on or off

### Power Indicator

- White: Battery level  $\geq 20\%$
- Red: Battery level  $< 20\%$
- Flashing slowly: Charging or starting up
- Flashing red: Error



### Dock/Spot Cleaning

- Press to return to the dock
- Press and hold to spot clean

### Note:

Press any button to pause cleaning, returning to dock, or spot cleaning.

### Reset WiFi

- Press and hold both the  button and the  button for 3 seconds.

# Product introduction

## Parts List

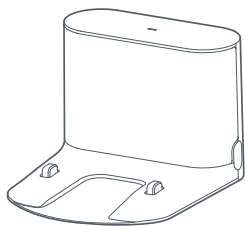

Charging Dock

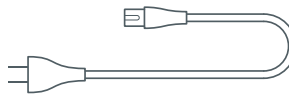

Power Cable

### Optional

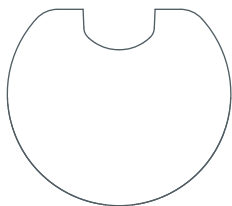

Moisture-proof mat



Adjustable water tank



Mop cloth

# Product introduction

## Robot

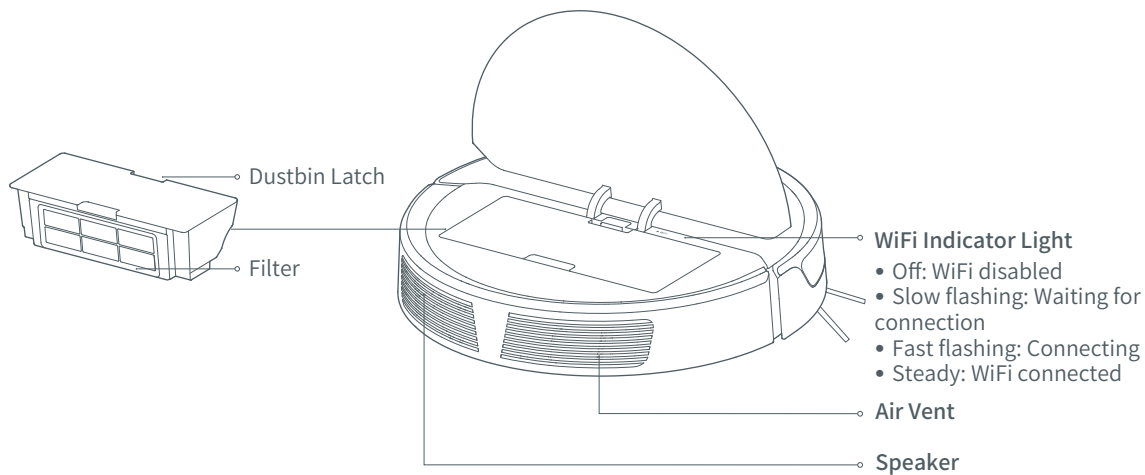

# Product introduction

## Robot and Sensors

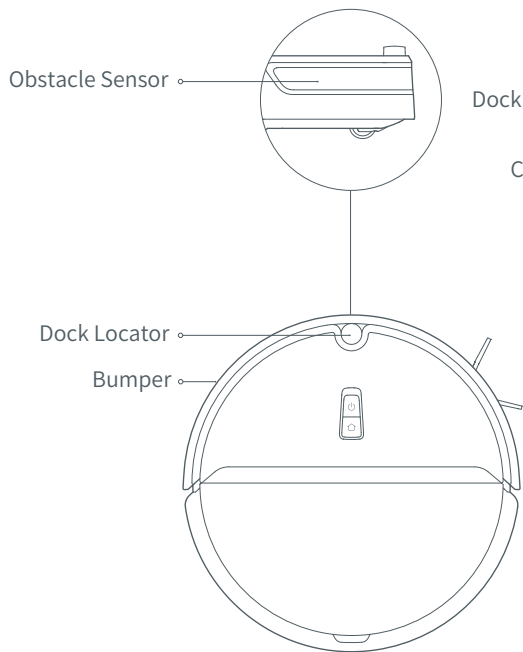

## Charging Dock

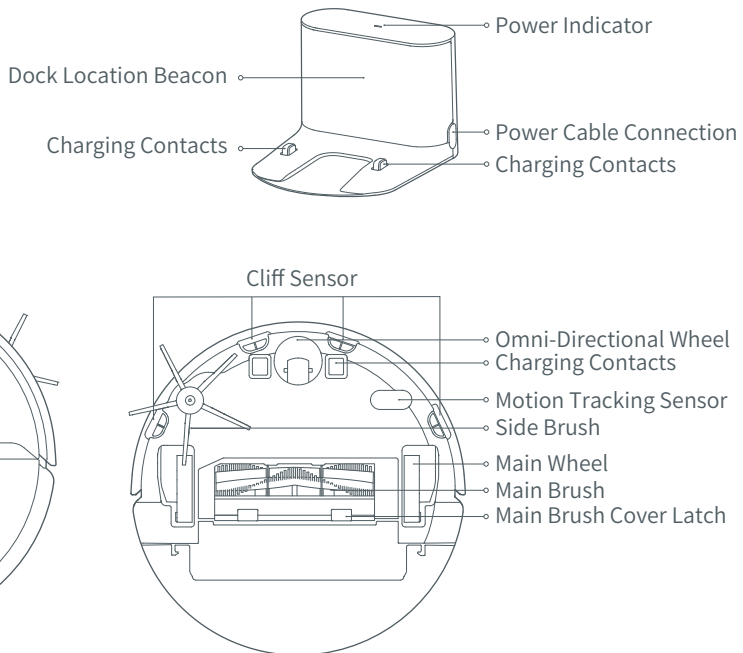

# Installation

## Using the robot

1. Place the Charging Dock against the wall on a flat surface and plug it into mains power.

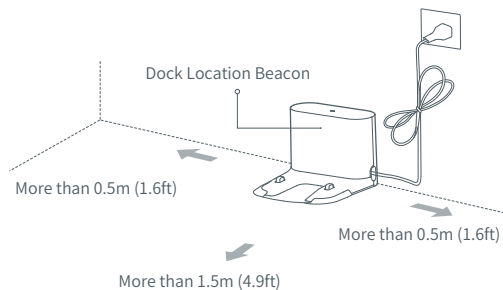

### Notes:

- Ensure that a distance of at least 0.5m on both sides and 1.5m in front is retained around the Charging Dock.
- The Power Cable, when vertical to the floor, may get caught by the robot, disconnecting the Charging Dock.
- The Power Indicator is on when the Charging Dock is connected to mains power, and off when the robot is charging.
- For a better app user experience, place the Charging Dock in an area with a strong WiFi signal.
- To avoid problems returning to the dock, do not place the Charging Dock in direct sunlight or block the Dock Location Beacon
- Do not place the Charging Dock in passageways or doorways. This may prevent access due to the safe zone around the dock.

## Using the robot

2. Secure the moisture-proof mat. **(Optional)**

After securing the charging dock, wipe the area where the moisture-proof mat will be placed with a dry cloth as shown. Stick the double-sided tape first to the moisture-proof mat then in position on the floor.

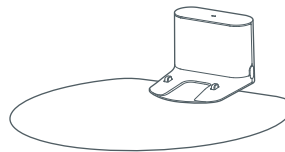

### Note:

Always use the moisture-proof when placing the charging dock on a wooden floor.

# Installation

## 3. Power on and charge.

Press and hold the  button to power on. When the Power Indicator is on, place the robot on the Charging Dock to charge.

This robot is equipped with a high-performance lithium-ion rechargeable battery pack. To maintain battery performance, keep the battery charged.

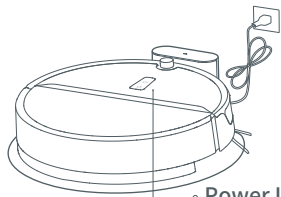

Power Indicator color indicates battery level.

- White: Battery level  $\geq 20\%$
- Red: Battery  $< 20\%$

### Note:

The robot cannot be powered on when the battery is low. Place the robot on the Charging Dock to recharge.



# Installation

## 4. Connect to the mobile app. (recommended)



This robot uses the Mi Home app. Through the MIUI system, it can be connected to other compatible smart home products.

### ① Download app

Search for "Mi Home" in the App Store or Google Play or scan the QR code below, then download and install the app.



### ② Reset WiFi

- a. Open the top cover of the robot to reveal the WiFi indicator light.
- b. Press and hold the  button and the  button until you hear the "Reset WiFi" voice alert. When the WiFi Indicator Light flashes slowly, the robot has entered network configuration mode.

Note:

If you cannot connect your phone to the robot, reset the WiFi, and add your robot as a new device.

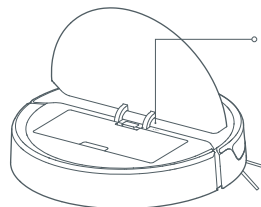

### WiFi Indicator Light

- Off: WiFi disabled
- Slow flashing: Waiting for connection
- Fast flashing: Connecting
- Steady: WiFi connected

### ③ Add device

Open the Mi Home app and tap the "+" in the top right corner. Add the robot by following the in-app prompts. After adding, the robot can be found on the home page.

Note:

- Due to ongoing Mi Home development, the actual process may differ slightly from the above description. Always follow the instructions given in the app.
- Only 2.4GHz WiFi is supported.

# Installation

## Using the robot

### 5. Mopping (Optional)

Note:

- It is recommended that all floors are vacuumed at least three times before the first mopping session to reduce excessive dirt buildup on the mop.
- Use barrier tape to prevent mopping carpeted areas, or remove carpets prior to mopping.
- To prevent corrosion or damage, do not use cleaning fluid or disinfectant in the water tank.
- Cleaning the mop cloth every 60 minutes is recommended to ensure the water flow rate and cleaning effect.

#### ① Adjust flow rate

Toggle the switch to adjust the flow rate according to your needs.

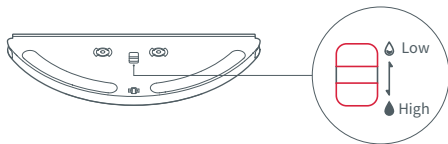

#### ② Fill the water tank

Open the water tank, fill it with water, and close it tightly

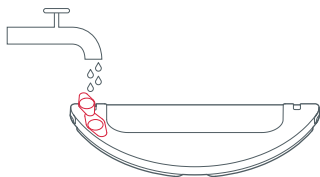

#### ③ Install the mop cloth

Dampen the mop cloth and squeeze it until it stops dripping. Insert it into the mounting slot in the water tank.

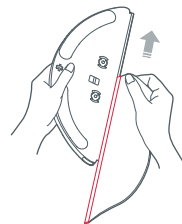

#### ④ Install the module

Slide the mop module in line with the alignment marks on the rear of the machine until you hear a "click".

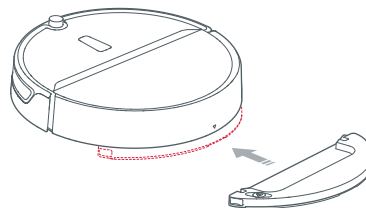

# Installation

## Using the robot

### 6. Start cleaning. (Optional)

When the battery is fully charged, the Power Indicator will remain lit. Press the  button or use the app to start a cleanup.

### 7.Remove the mopping module. (Optional)

After the machine completes cleaning and returns to the charging dock, press the two side latches inwards and pull to remove the mopping module.

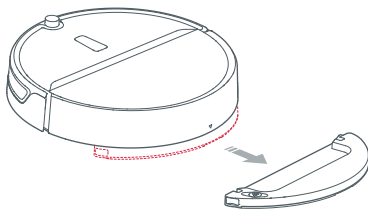



#### Note:

- When the charging dock is placed on a wooden floor, always use it with the moisture-proof mat to prevent moisture damage.
- Remove the mopping module after mopping, empty residual water and clean the mop cloth to prevent mildew or unpleasant odors.
- Remove the mopping module if not mopping.

# Instructions for use

## On/off

Press and hold the  button to power on the robot. The Power Indicator will turn on, and the robot will enter standby mode. If the robot is idle, press and hold the  button to power it off and end the current cleaning cycle.

Note:

The robot cannot be turned off when it is charging.

## Clean

Press the  button to start cleaning. Press any button to pause the current cleaning cycle.

Note:

- Cleaning cannot start if the battery level is too low. Allow the robot to charge before restarting cleanup.
- Tidy away any cables on the ground (including the Charging Dock Power Cable) before cleaning to avoid losing power or damaging either the robot or the cables.
- If a cleanup finishes within 10 minutes, cleaning repeats by default.
- If the battery runs low before cleanup is complete, the robot will return to the dock for a top-up charge before resuming cleanup from where it left off.

## Charging

Auto mode: After cleaning, the robot will automatically return to the Charging Dock.



Manual: If Paused, press the  button to send the robot back to the Charging Dock.

The Power Indicator breathes when the robot is charging.

Note:

If the robot cannot find the Charging Dock, it will return to the most recent starting location. Place the robot on the Charging Dock manually to recharge.

## Pause

When the robot is cleaning, press any button to pause it. Press the  button to continue cleaning or the  button to stop cleaning and send it back to the Charging Dock.

Notes:

- Manually docking the robot in Pause mode will stop the current cleaning cycle.
- If continuing to clean after moving the robot, place it close to its original position before starting.

## Cleaning method

Once started, the robot will clean in a Z pattern. Once all areas have been covered, it will clean along the wall to effectively cover the entire floor. It will then automatically return to the Charging Dock.



# Instructions for use

## Spot cleaning

In Standby or Pause mode, press and hold the  button to start Spot Cleaning. The robot will clean a 1.2m (3.9ft) in diameter circle spiraling out from its starting point. After cleaning, the robot will return to the start point.

Note:

Starting Spot Cleaning in pause mode will stop the current cleaning cycle.

## Errors

If a runtime error occurs, the Power Indicator will flash red quickly, and a voice prompt will sound. Refer to “Troubleshooting” for details.

Notes:

- The robot will automatically enter Sleep mode after 10 minutes of inactivity in an Error state.
- Docking the robot in an Error state will stop the current cleaning cycle.



## Sleep

If inactive for more than 10 minutes, the robot will automatically enter Sleep mode. The Power Indicator will flash every few seconds. Press any button to wake the robot.

## Scheduled Cleaning

Use the mobile app to set scheduled cleanups. The robot will automatically clean at the specified times and return to the Charging Dock after each clean.

## Reset WiFi

If a mobile phone cannot connect to the robot due to router configuration changes, forgotten password, or any other reason, reset the WiFi. Open the top cover to reveal the WiFi Indicator, then press and hold the  and  buttons until the "Resetting WiFi" voice alert sounds. The reset is complete when the WiFi indicator flashes slowly.

Note:

WiFi will be automatically disabled if the time taken to connect exceeds one hour. If you need to reconnect, reset the WiFi, and try again.

## Suction Power

Use the Mi Home app to choose from Quiet, Balanced, Strong, or MAX modes. The Balanced mode is the default.

## Do Not Disturb (DND) mode

When DND mode is activated, an active cleaning cycle will finish, no voice alerts will sound, and the Power Indicator Light will dim. DND mode is enabled by default from 22:00 to 08:00. You can use the mobile app to disable Do Not Disturb mode or change its effective time.

# Routine Maintenance

## Dustbin and Filter

\*Clean weekly

1. Open the top cover of the robot, press the Dustbin Latch, then lift and remove the Dustbin.

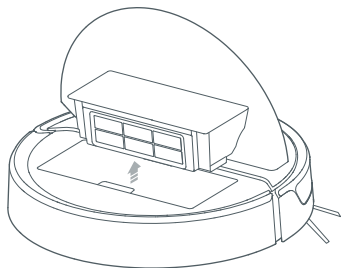

2. Remove the Filter and empty the Dustbin.

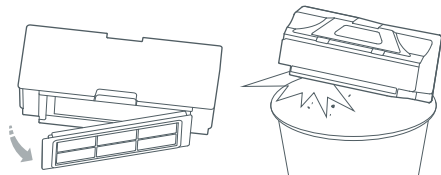

## Main Brush

\*Clean weekly

1. Flip the robot over and press the Main Brush Cover Latch to remove the Main Brush Cover.
2. Remove the Main Brush and clean its bearings.
3. Remove any entangled hair.
4. Reinstall the Main Brush and replace the Main Brush Cover.

Note:

Replacing the Main Brush every 6-12 months is recommended for proper cleaning.

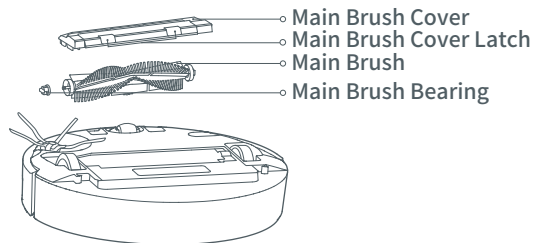

## Routine Maintenance

### Clean the washable Filter

\*Clean every two weeks

1. Fill the Dustbin with clean water. Gently shake it, then pour out the dirty water.

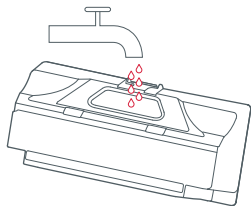

Note:

To prevent Filter blockages, only use fresh water. Do not use cleaning liquids.

2. Remove the Filter and rinse it with water.

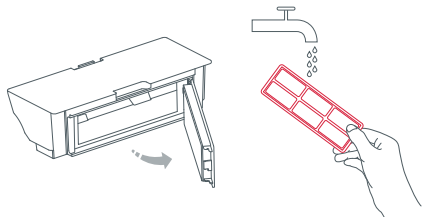

Note:

To avoid damage, do not touch the surface of the Filter with hands, brushes, or sharp objects.

3. If necessary, rinse the filter and tap the Filter frame repeatedly to remove as much dirt as possible.



4. Leave the Filter to dry before reinstalling it.

Note:

Dry the Filter thoroughly before use. (At least 24 hours)

### Battery

The robot is equipped with a high-performance lithium-ion rechargeable battery pack. To maintain battery performance, keep the robot charged.

Note:

If the robot is to be left unused for an extended period, turn it off before storage and charge it at least once every three months to avoid battery damage resulting from over-discharging.

### Charging Dock

\*Clean monthly

Use a soft dry cloth to clean the charging contacts.

# Routine Maintenance

## Side Brush

\* Clean monthly

1. Turn the robot over and remove the screw holding the Side Brush.
2. Remove and clean the Side Brush.
3. Reinstall the Side Brush and tighten the screw.

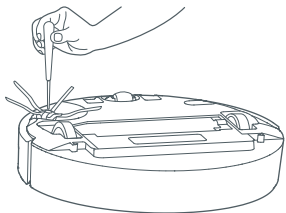

Note:

It is recommended to replace the Side Brush every 3-6 months to maintain the cleaning quality.

## Mop cloth (Optional)

\*Clean after use

1. Remove the mop cloth from the mopping module.

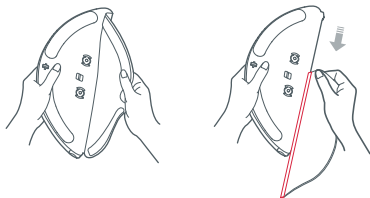

2. Clean and dry the mop cloth.

Note:

- Always remove the mop cloth after cleaning to filter blockage.
- If the mop cloth gets excessively dirty, the cleaning quality will be affected. Always use a clean cloth.
- Replacing the mop cloth every 3-6 months is recommended to maintain cleaning quality.

## Filter assembly (Optional)

\*Replacement every 1-3 months is recommended

1. Move your finger along the notch to remove both filters.
2. Install the new filters.



Note:

Changing filters every 1-3 months is recommended, depending on the quality of water and frequency of use, to ensure cleaning quality.



# Routine Maintenance

## Omni-Directional Wheel

\* Clean as required

1. Turn the robot over.
2. Use a small screwdriver to pry out the axle and remove the wheel.
3. Rinse the axle and the wheel with water to remove hair and dirt.
4. Dry and press the wheel back in place.

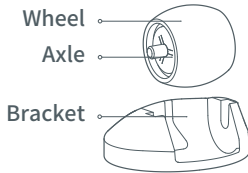

Note:  
The Omni-Directional Wheel bracket cannot be removed.

## Robot Sensors

\*Clean as required

Use a soft dry cloth to wipe and clean all sensors, including:

1. Four Cliff Sensors on the bottom of the robot.
2. Obstacle Sensor at the front of the robot.
3. Charging contacts on the bottom of the robot.
4. Motion Tracking Sensors on the bottom of the robot.

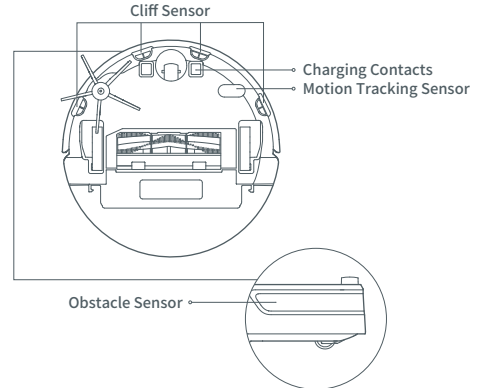

# Troubleshooting

If an error occurs during the cleanup, the Power Indicator will flash red quickly, and a voice alert will play. Refer to the table below for resolution options.

Error	Solution
Error 2: Clean and lightly tap the Bumper.	The Bumper is stuck. Lightly and repeatedly tap the Bumper to remove any foreign matter. If no foreign matter is found, move the machine to a new location and restart.
Error 3: Move the robot closer to its starting location and restart.	The wheels are suspended. Move the robot closer to its starting location and try again.
Error 4: Wipe the Cliff Sensors and move the robot closer and try again.	The wheels are suspended. Move the robot closer and try again. This error may also be caused by dirty Cliff Sensors. Wipe the Cliff Sensors and retry.
Error 5: Remove the Main Brush and clean the brush and bearings.	The Main Brush may have become entangled with debris. Remove and clean the Main Brush and its bearing.
Error 6: Remove and clean the Side Brush.	The Side Brush may be entangled with debris. Remove and clean it.
Error 7: Remove any debris entangled in the main brush. Move the robot closer and restart.	The Main Wheels may be jammed. Remove and clean them.
Error 8: Clear away any obstacles around the robot.	The robot may be stuck. Clear any obstacles around it.
Error 9: Install the Dustbin and Filter.	Reinstall the Dustbin and Filter. Check that they are installed properly. If the problem persists, try replacing the Filter.
Error 10: Make sure that the Filter is dry or clean the Filter.	The Filter is not completely dry. Dry the Filter for at least 24 hours. The Filter may also be blocked and require cleaning. If the problem persists, replace the Filter.

# Error

Error 12: The battery is too low. Recharge before use.	Low battery. Recharge before use.
Error 13: Charging error. Clean the charging contacts.	Use a dry cloth to clean the Charging Contacts on the robot and on the Charging Dock.
Error 14: Battery error.	The battery temperature is either too high or too low. Wait until it returns to normal.
Error 17: Side Brush module error. Reset the system.	The Side Brush is experiencing a fault. Reset the system.
Error 18: Vacuum fan error. Reset the system.	The vacuum fan is experiencing a fault. Reset the system.
Error 20: Clean the Motion Tracking Sensor and place the back where it stopped.	The Motion Tracking Sensor may be dirty. Use a dry cloth to wipe the Sensor then place the robot back where it stopped before restarting.
Error 23: Clean the Dock Location Beacon.	The Dock Location Beacon is dirty. Wipe it clean.
Internal error. Reset the system.	Malfunction due to an internal error. Reset the system.

# FAQs

Problem	Solution
Unable to power on	The battery level is low. Put the robot on the Charging Dock to charge it before use. The battery temperature is too low or too high. Only use the robot within the range of 4-40°C (39-104°F).
Unable to charge	If the Charging Dock is not receiving power, check that both ends of the Power Cable are properly connected. If contact is poor, clean the contact areas of the Charging Dock and the robot. Power is restored when the Power Indicator light turns on.
Slow charging	When used at high or low temperatures, the robot will automatically reduce the charging speed to extend battery life. The charging contact areas may be dirty. Use a dry cloth to clean them.
Unable to reach the dock	There are too many obstacles near the Charging Dock. Clear the area or move the dock. The robot is too far from the Charging Dock. Place it closer and retry.
Abnormal behavior	Restart the robot.
Noise during cleaning	The Main Brush, Side Brush, or Main Wheels may be jammed. Turn off the robot and clean them. If the Omni-Directional Wheel is jammed, remove it for cleaning.
Poor cleaning ability or dust falling out	The Dustbin is full and needs emptying. The Filter is blocked and needs cleaning. The Main Brush is jammed and needs cleaning.
Unable to connect to WiFi	WiFi is disabled. Reset the WiFi and try again. The WiFi signal is poor. Make sure that the robot is in an area with good WiFi signal reception. Abnormal WiFi connection. Reset the WiFi then download the latest mobile app and retry. Unable to connect to WiFi. There may be an error with your router settings. Contact Roborock customer service for troubleshooting.
Scheduled cleaning is not working	The battery level is too low. Scheduled cleaning can only begin when the battery level is above 20%.
Is power always being drawn when the robot is on the Charging Dock?	The robot will draw power while it is docked to maintain battery performance, but power consumption is extremely low.
Does the robot need to be charged for at least 16 hours the first three times it is used?	No. The robot can be used any time after it has been fully charged once.

## FAQs

Problem	Solution
Cleaning does not resume after recharging	Make sure that the robot is not in DND mode. DND mode will prevent cleanup. When cleaning a space requiring a top-up charge, if the robot was placed manually on the Charging Dock before it recharged automatically, it will not be able to continue cleanup.
The robot cannot return to the Charging Dock after spot cleaning or when it has been moved manually.	After spot cleaning or a significant position change, the robot will re-generate the map. If the Charging Dock is too far away, it may not be able to return for recharging and must be placed on the charger manually.
The robot has started missing certain spots	The Obstacle Sensor may be dirty. Clean it with a soft dry cloth.
No or little water during mopping	Please check whether there is water in the water tank, rinse the mopping cloth, replace the filter or follow the instructions in the user manual to correctly install the mopping cloth.
Too much water during mopping	Please make sure that the water tank cover and the filter are properly installed in place.

## Routine Maintenance



### System Reset

If the robot does not respond when you press a button or the robot cannot be shut down, reset the system by pressing and holding the  button. The robot will restart automatically after resetting.

### Firmware Update

Update the robot using the Mi Home app. Place the robot on the Charging Dock and ensure that the battery level is higher than 20% before updating. The Power Indicator will flash white quickly during a firmware update.

### Restore Factory Settings

If the robot is not functioning after a system reset, press and hold the  button and the  button together until the "Restoring factory settings" voice alert sounds. The robot will then be restored to factory settings. Ignore the "Reset WiFi" voice alert.

### Holiday Energy Saving Function

When the robot is docked, press and hold "Recharge" for 10 seconds or until you hear an alert sound. This will activate Holiday mode.

In this mode the robot will switch to Low Power mode to minimize power consumption. This includes a dimming of the LED indicator, and the stopping of all non-charging related functions including cleaning, remote control over Wi-Fi, and more.

To deactivate Holiday mode, press and hold "Recharge" for 10 seconds until the LED indicator brightens.

## Basic Parameters

### Robot

Name	Parameters
model	roborock E4
Dimensions	350×350×90.5mm
Battery	14.4V/5200mAh lithium battery
Weight	Approx. 3.0kg
Wireless Connection	WiFi Smart Connect
Rated voltage	14.4VDC
Rated Power	58W
Charging Time	<6h

### Charging Dock

Name	Parameters
Model	CDZ14RR or CDZ15RR
Dimensions	151×130×98mm
Rated Power	28W
Rated Input	100-240 VAC
Rated Output	20VDC 1.2A
Rated Frequency	50-60Hz
Charging Battery	14.4V/5200mAh lithium battery



## Robot Vacuum Cleaner

Manufacturer: Beijing Roborock Technology Co., Ltd.

Product Model: roborock E4

Address of Manufacturer: Floor 6, Suite 6016, 6017, 6018, Building C, Kangjian Baosheng Plaza,  
No.8 Heiquan Road, Haidian District, Beijing, P.R.CHINA

For more product information, visit our website: [www.roborock.com](http://www.roborock.com)

For after-sales support, email our after-sales service team:

US/Non-Europe Support: [support@roborock.com](mailto:support@roborock.com)

Europe Support: [support@roborock-eu.com](mailto:support@roborock-eu.com)

