

# BlastIR Wireless

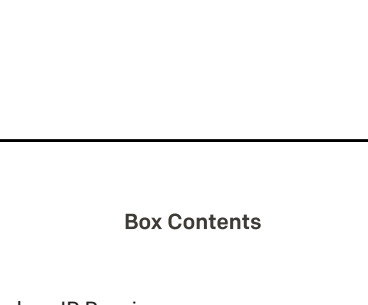

## Box Contents

- BlastIR Wireless IR Receiver
- BlastIR Wireless IR Emitter
- Dual IR Emitter Cable
- IR Receiver Cable
- (2) Airstick™ Microsuction Tape
- (2) 3m Adhesive
- (2) 5V .5A Power Supply
- (2) USB to DC Cable
- (2) Rubber Magnet Feet

## FCC Statement



This device complies with part 15 of the FCC Rules. Operation is subject to the following two conditions: (1) this device may not cause harmful interference, and (2) this device must accept any interference received, including interference that may cause undesired operation.

1

## Setup: Step One

Insert power cable here on both units



Connect each unit to power using either the included power supplies or the USB to DC cables.

It is easy to mistake the IR cable port on the front for the power port. Please ensure that the power adapter is plugged into the appropriate port at the back.

2

## Setup: Step Two

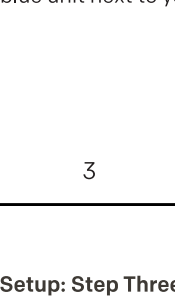

Place the blue unit next to your display.

3

## Setup: Step Three

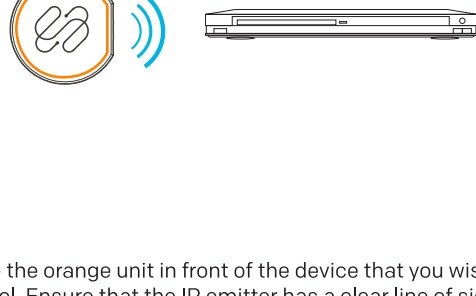

Place the orange unit in front of the device that you wish to control. Ensure that the IR emitter has a clear line of sight to the IR "eye" of your device.

4

## Optional IR Cables

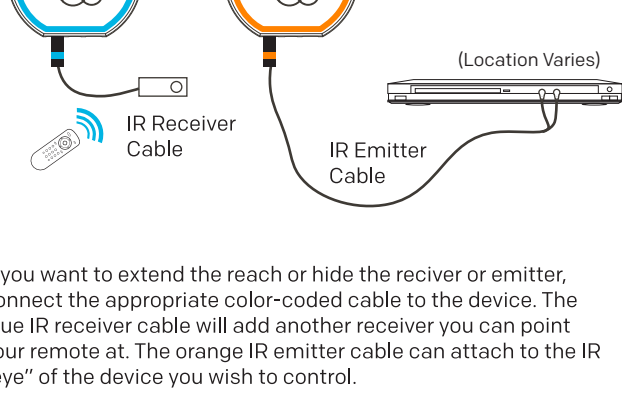

If you want to extend the reach or hide the receiver or emitter, connect the appropriate color-coded cable to the device. The blue IR receiver cable will add another receiver you can point your remote at. The orange IR emitter cable can attach to the IR "eye" of the device you wish to control.

5

## Optional Adhesive Placement

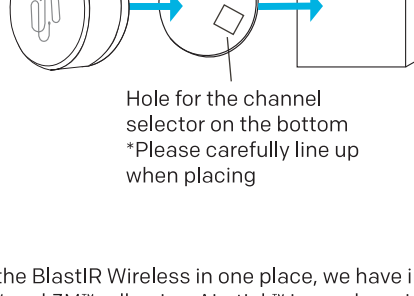

Hole for the channel selector on the bottom  
\*Please carefully line up when placing

To keep the BlastIR Wireless in one place, we have included Airstick™ and 3M™ adhesive. Airstick™ is used as pictured above and it is designed to be reusable and leave no residue. The 3M™ adhesive is used the same way and is used for a more permanent placement.

6

## Optional Magnetic Placement

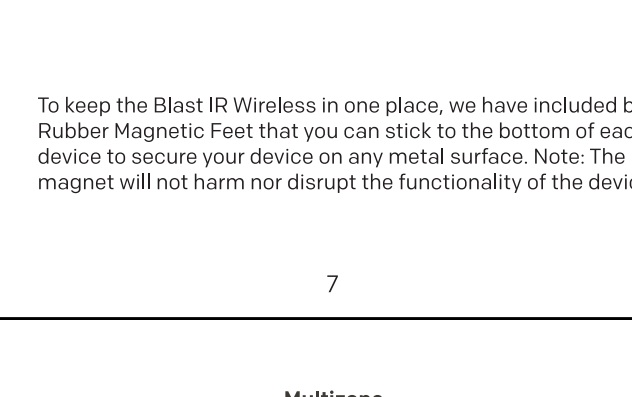

To keep the Blast IR Wireless in one place, we have included blue Rubber Magnetic Feet that you can stick to the bottom of each device to secure your device on any metal surface. Note: The magnet will not harm nor disrupt the functionality of the device.

7

## Multizone

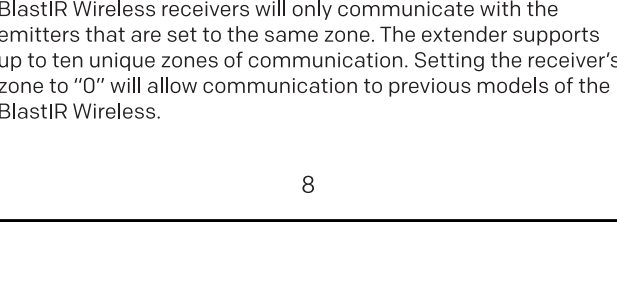

BlastIR Wireless receivers will only communicate with the emitters that are set to the same zone. The extender supports up to ten unique zones of communication. Setting the receiver's zone to "0" will allow communication to previous models of the BlastIR Wireless.

8

## Possible Setups

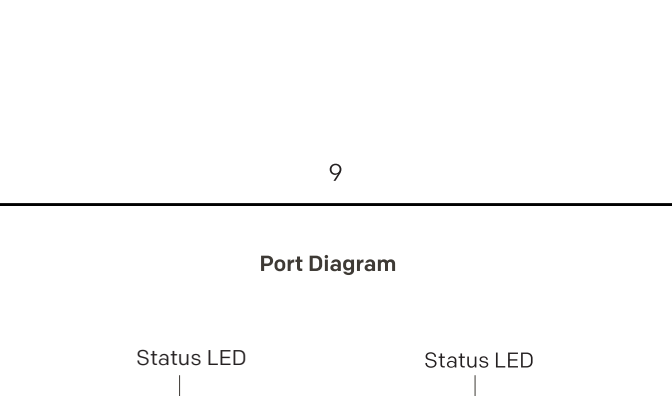

9

## Port Diagram

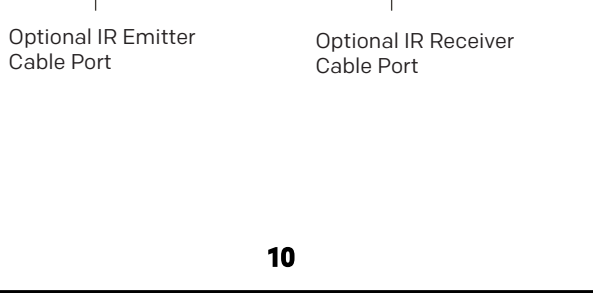

10

## Need Help?

- Phone** 800. 709. 1345
- Email** support@sewelldirect.com
- Chat** sewelldirect.com/support

Live support available Monday through Friday 9AM-8PM EST

If you have anything less than a 5-star experience, please let us be the first to know and we'll make it right!

★★★★★ [sewelldirect.com/support](http://sewelldirect.com/support)

# BlastIR Wireless

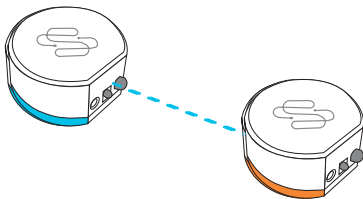

## Box Contents

BlastIR Wireless IR Receiver  
BlastIR Wireless IR Emitter  
Dual IR Emitter Cable  
IR Receiver Cable  
(2) Airstick™ Microsuction Tape  
(2) 3m Adhesive  
(2) 5V .5A Power Supply  
(2) USB to DC Cable  
(2) Rubber Magnet Feet

### FCC Statement



This device complies with part 15 of the FCC Rules. Operation is subject to the following two conditions: (1) this device may not cause harmful interference, and (2) this device must accept any interference received, including interference that may cause undesired operation.

## Setup: Step One

Insert power cable  
here on both units

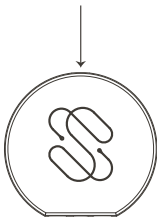

Connect each unit to power using either the included power supplies or the USB to DC cables.

It is easy to mistake the IR cable port on the front for the power port. Please ensure that the power adapter is plugged into the appropriate port at the back.

## Setup: Step Two



Place the blue unit next to your display.

### Setup: Step Three

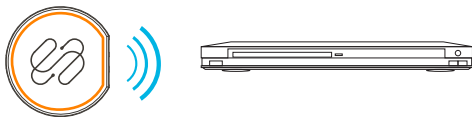

Place the orange unit in front of the device that you wish to control. Ensure that the IR emitter has a clear line of sight to the IR "eye" of your device.

## Optional IR Cables

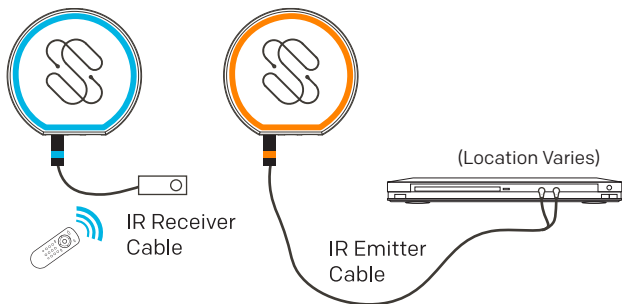

If you want to extend the reach or hide the receiver or emitter, connect the appropriate color-coded cable to the device. The blue IR receiver cable will add another receiver you can point your remote at. The orange IR emitter cable can attach to the IR "eye" of the device you wish to control.

## Optional Adhesive Placement

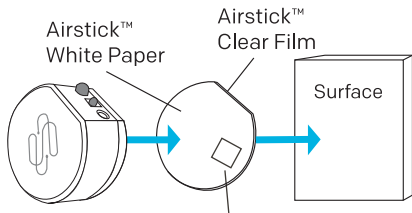

Hole for the channel selector on the bottom  
\*Please carefully line up when placing

To keep the BlastIR Wireless in one place, we have included Airstick™ and 3M™ adhesive. Airstick™ is used as pictured above and it is designed to be reusable and leave no residue. The 3M™ adhesive is used the same way and is used for a more permanent placement.

## Optional Magnetic Placement

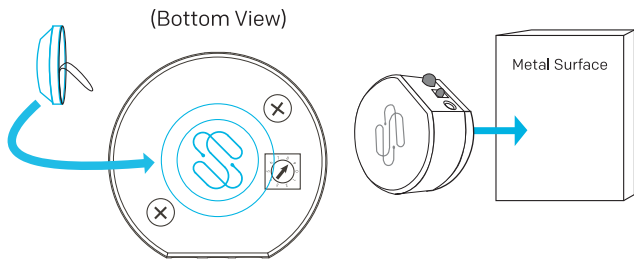

To keep the Blast IR Wireless in one place, we have included blue Rubber Magnetic Feet that you can stick to the bottom of each device to secure your device on any metal surface. Note: The magnet will not harm nor disrupt the functionality of the device.

## Multizone

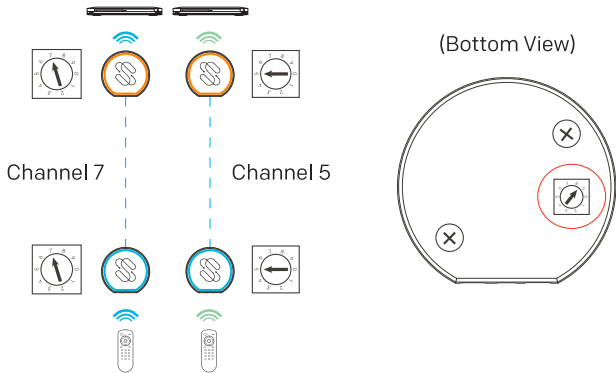

BlastIR Wireless receivers will only communicate with the emitters that are set to the same zone. The extender supports up to ten unique zones of communication. Setting the receiver's zone to "0" will allow communication to previous models of the BlastIR Wireless.

## Possible Setups

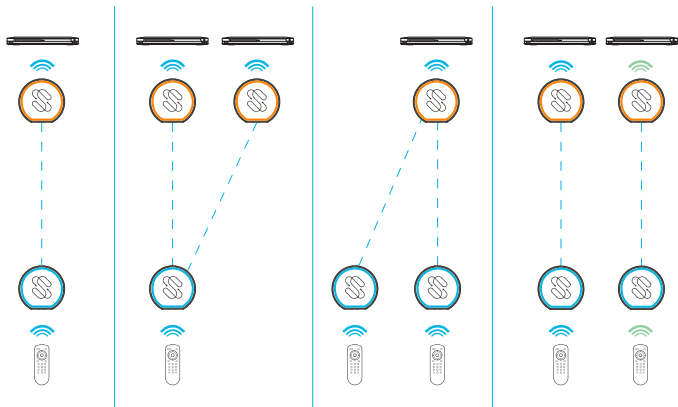

## Port Diagram

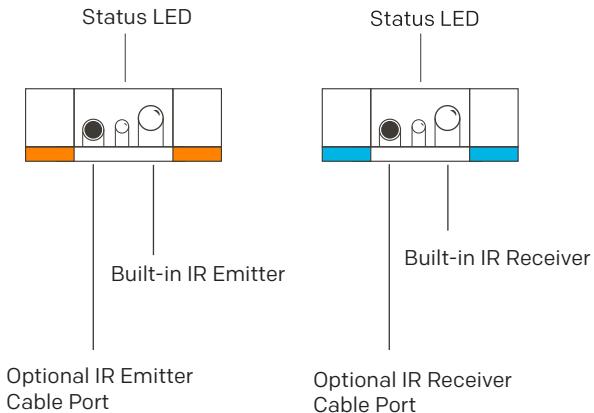

# Need Help?

**Phone** 800.709.1345

**Email** [support@sewelldirect.com](mailto:support@sewelldirect.com)

**Chat** [sewelldirect.com/support](https://sewelldirect.com/support)

Live support available Monday  
through Friday 9AM-8PM EST

---

If you have anything less than a 5-star experience,  
please let us be the first to know and we'll make it right!

★★★★★ [sewelldirect.com/support](https://sewelldirect.com/support)

---