

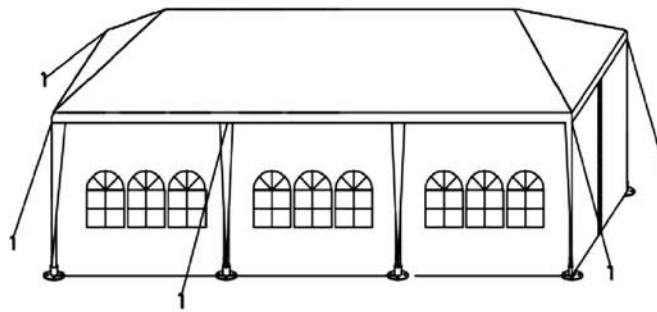



















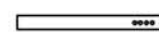

# PARTY TENT

## ASSEMBLY INSTRUCTION

<http://www.paylesshere.com>



THANK YOU FOR PURCHASING BEST PARTY TENT PT-1030-8-WHITE  
PARTS LIST

NO	Image	Qty	NO	Image	Qty
<b>1</b>		<b>8</b>	Plastic Angle Connector		<b>4</b>
<b>2</b>		<b>4</b>	Middle Connector		<b>4</b>
<b>3</b>		<b>16</b>	Top Connector		<b>2</b>
<b>4</b>		<b>8</b>	Top Middle Connector		<b>2</b>
<b>5</b>		<b>8</b>	Plastic Foot		<b>8</b>
<b>6</b>		<b>8</b>	Big Plastic Connector (0.95')	A 	<b>16</b>
<b>7</b>		<b>2</b>	Small Plastic Connector (0.71')	B 	<b>13</b>
<b>8</b>		<b>3</b>	Ground Peg		<b>8</b>
<b>10</b>		<b>4</b>	Peg Guide Rope		<b>8</b>
<b>11</b>		<b>1</b>	Roof Fabric		<b>1</b>
			Sidewall		<b>6</b>
			Door		<b>2</b>

①

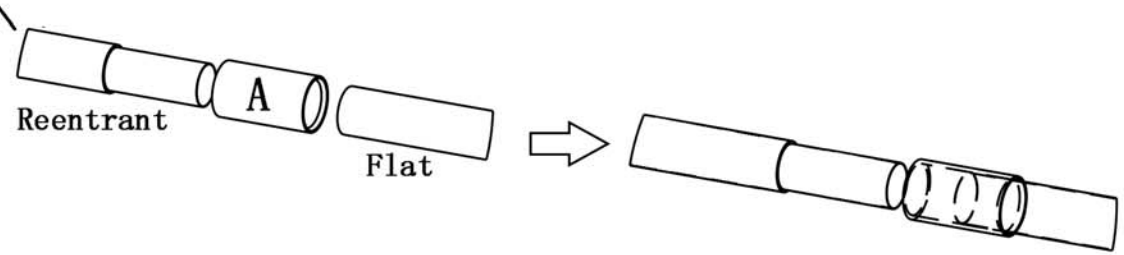
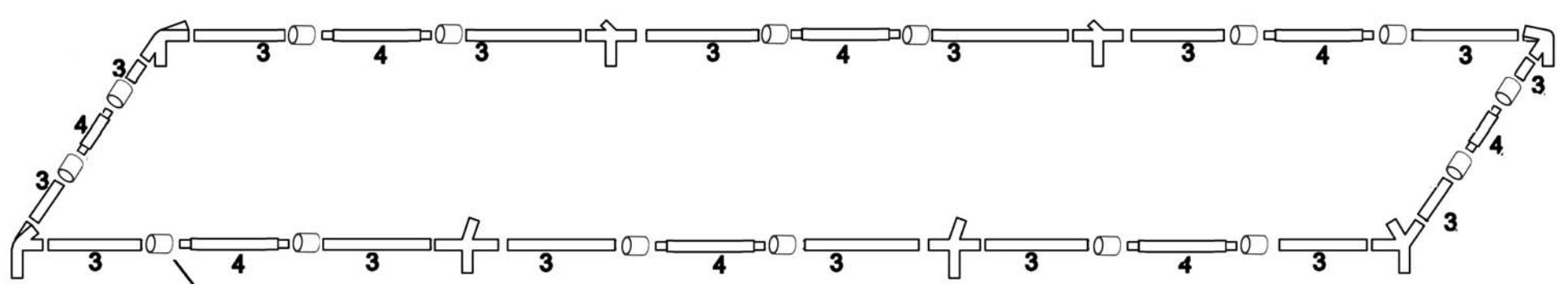

Attention: One end is concave, the other is flat

- 1' Please put the flat end of tube NO.3 into the the concave end of plastic A, then put the reentrant end of NO.4 into the flat end of plastic A.
- 2' Please make sure 1/2 plastic into the flat end of tube NO.3.
- 3' Please push hard to insert the tube into plastic, or you can depend on other tools.
- 4' Please make sure all the joints are connected well.

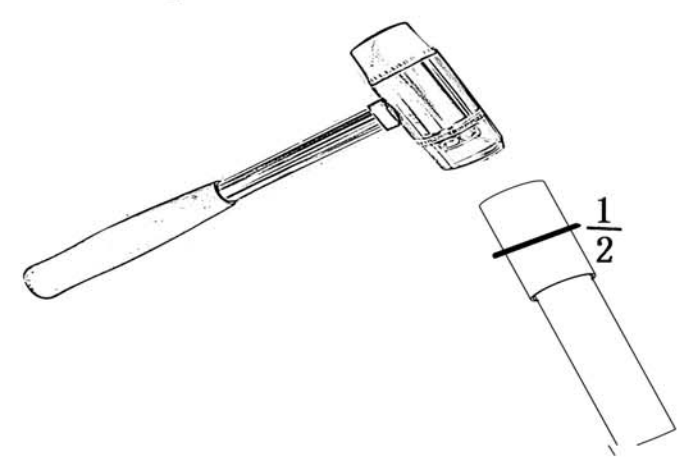

2

- 1' Please put the flat end of tube No.2/No.8/No.10 /No.11 into the the concave end of plastic B. then put the reentrant end of tube No.1/No.7 into the flat end of plastic B.
- 2' Please make sure 1/2 plastic into tube No.1/No.2/No.7 /No.8/No.10 /No.11.
- 3' Please push hard to insert the tube into plastic, or you can depend on other tools.
- 4' Please make sure all the joints are connected well.

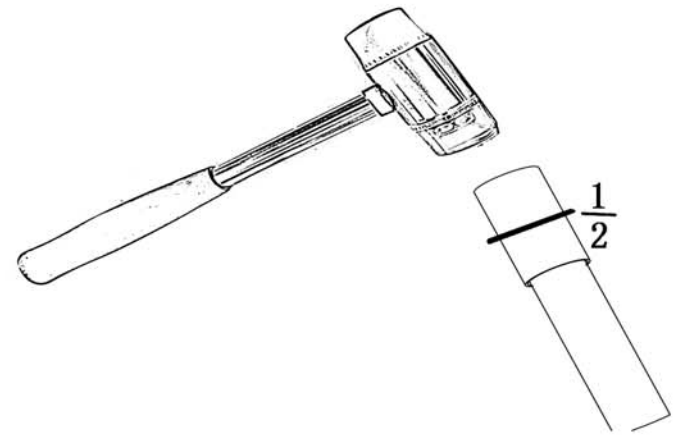

Attention: One end is concave, the other is flat

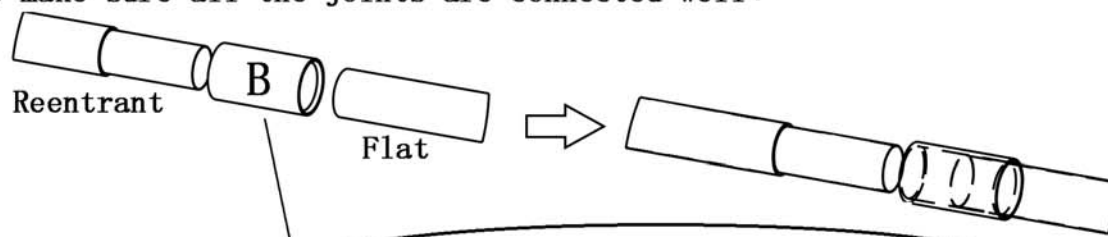

8# 11# tube pass the Plastic Connection

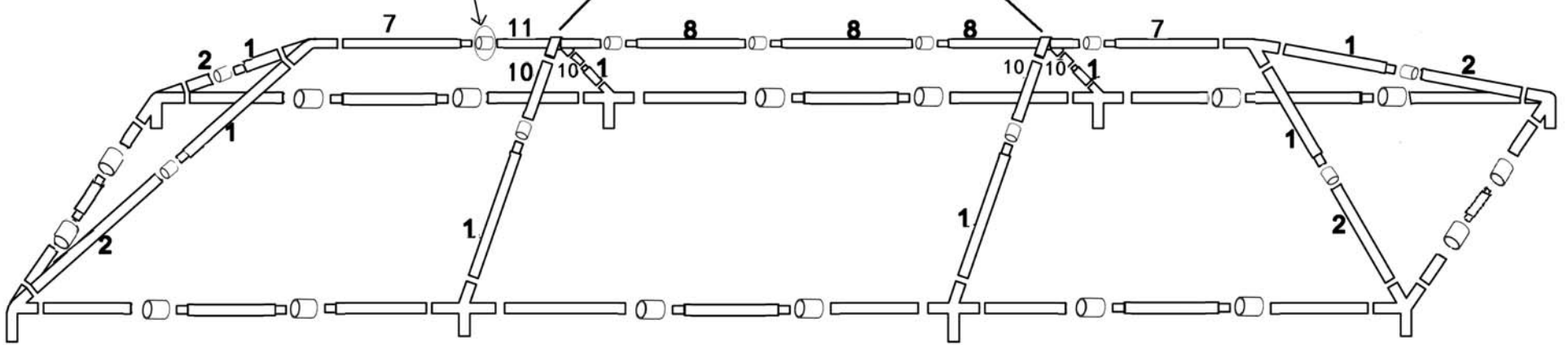

3

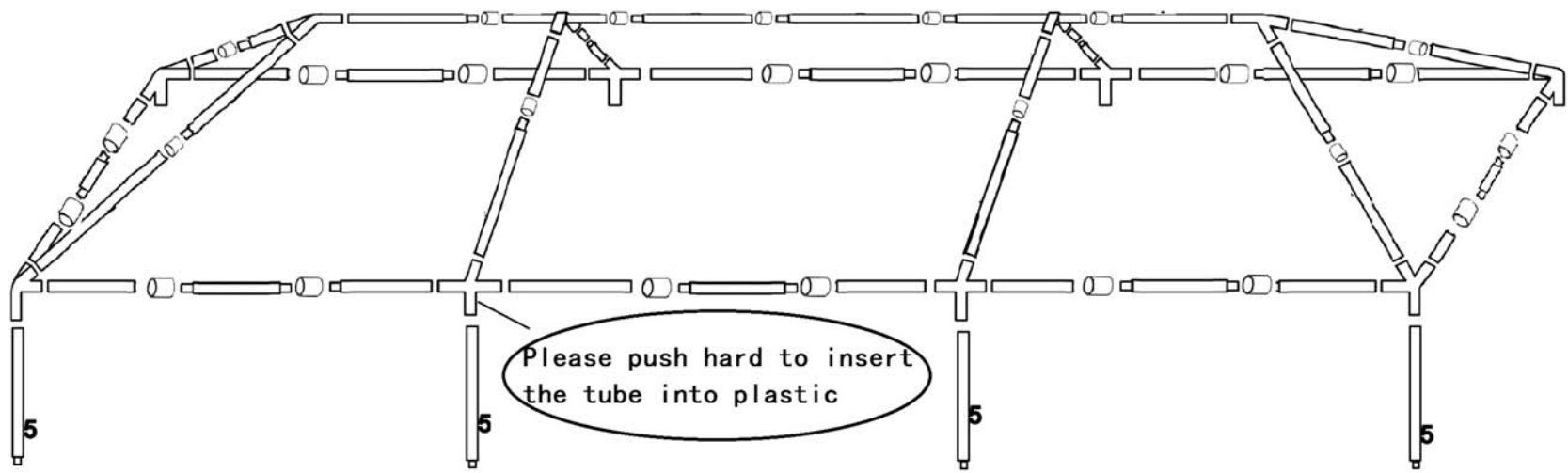

4

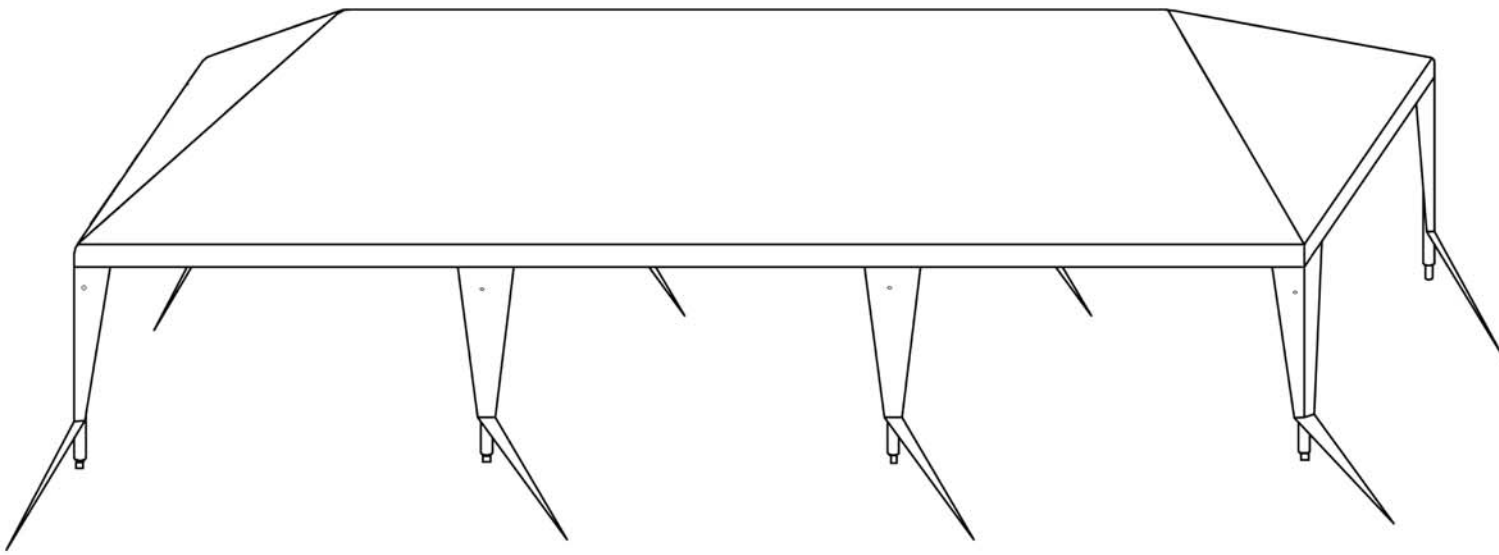

5

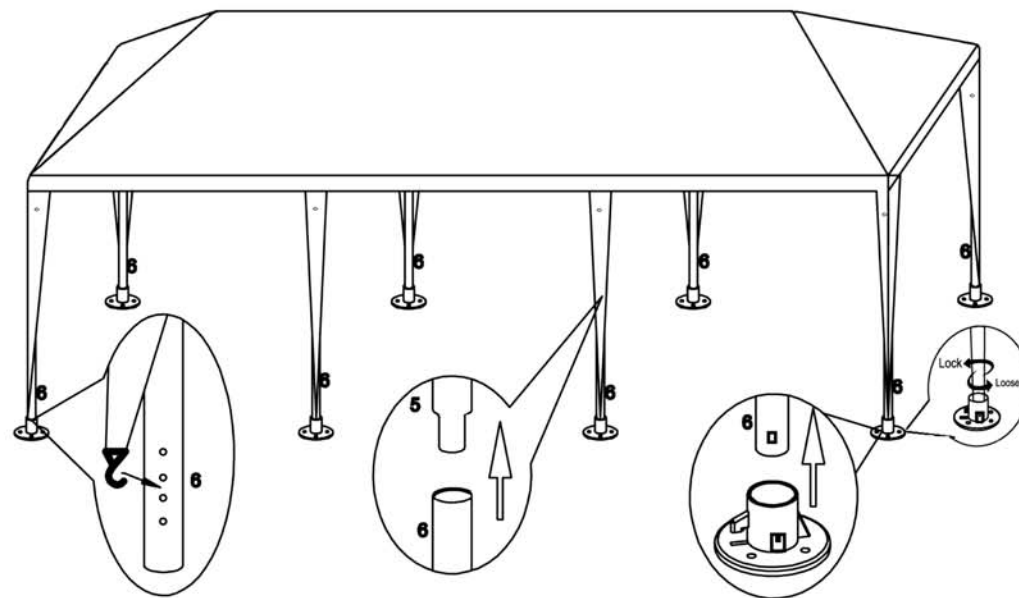

6

**Warning**

**1, when using product the nail must be inserted into the ground**  
**2, this product use on the turf only, cannot be used to concrete;**  
**3, snow and strong windy conditions, should be this goods recover, otherwise easy to collapse**

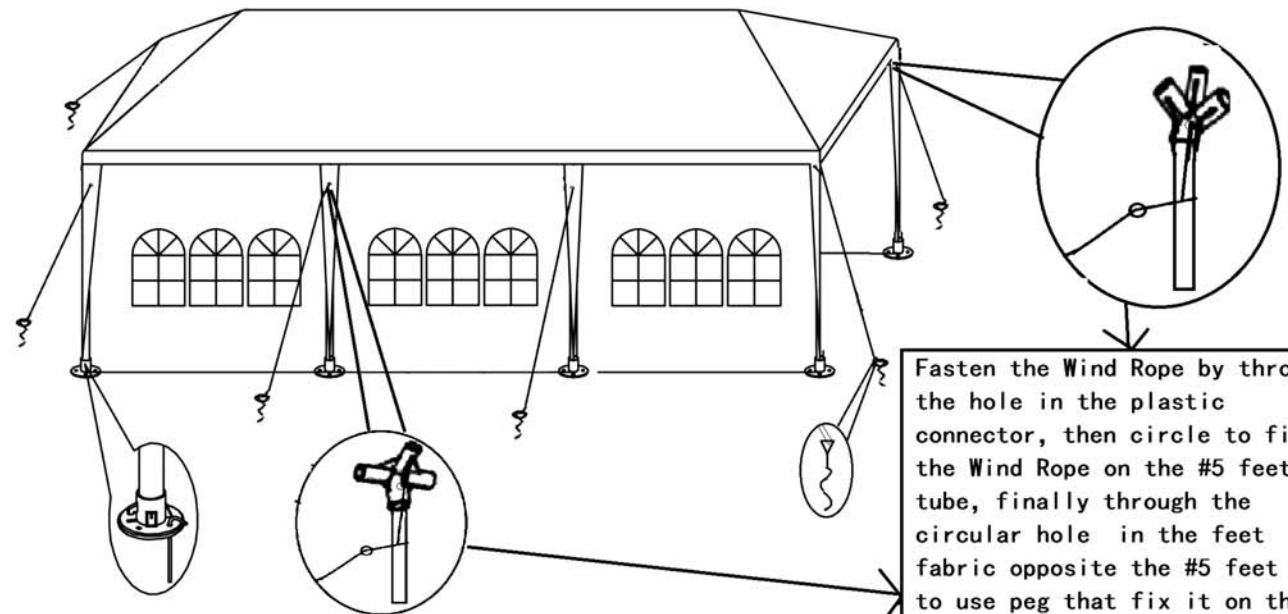

Fasten the Wind Rope by through the hole in the plastic connector, then circle to fix the Wind Rope on the #5 feet tube, finally through the circular hole in the feet fabric opposite the #5 feet tube to use peg that fix it on the ground.