

MICROWAVE CONVECTION OVEN INSTRUCTION MANUAL EC042A5C-SS



TOSHIBA

CONTENTS

PRODUCT SAFETY

IMPORTANT SAFETY INSTRUCTIONS WARNING	EN-3
---	------

PRODUCT INTRODUCTION

PRECAUTIONS TO AVOID POSSIBLE EXPOSURE TO EXCESSIVE MICROWAVE ENERGY	EN-6
GROUNDING INSTRUCTIONS	EN-7
MATERIALS YOU CAN USE IN MICROWAVE OVEN	EN-11
MATERIALS CAN NOT BE USED IN MICROWAVE OVEN	EN-12

INSTRUCTION FOR USE

SETTING UP YOUR OVEN	EN-13
OPERATION	EN-16
1. POWER LEVEL	EN-17
2. CLOCK SETTING	EN-17
3. KITCHEN TIMER	EN-18
4. MICROWAVE COOK	EN-18
5. CONVECTION COOK	EN-19
6. COMBINATION FUNCTION (CONVECTION + MICROWAVE)	EN-19
7. WARM HOLD FUNCTION	EN-20
8. ONE TOUCH START.....	EN-20
9. TIME DEFROST.....	EN-21
10. AUTO DEFROST FUNCTION	EN-21
11. AUTO BAKE FUNCTION	EN-22
12. AUTO ROAST FUNCTION	EN-22
13. SENSOR COOK	EN-23
14. SENSOR REHEAT	EN-24
15. POPCORN.....	EN-24
16. FAVORITE FUNCTION	EN-25
17. MUTI-STAGE COOKING	EN-26
18. INQUIRING FUNCTION	EN-26
19. TURN ON/OFF THE BUZZER SOUND	EN-27
20. ENERGY SAVER MODE	EN-27
21. LOCK FUNCTION	EN-27
22. COOKING END REMINDER FUNCTION	EN-28
23. OTHER SPECIFICATIONS	EN-28
24. TURNTABLE RESET FUNCTION	EN-28

MAINTENANCE

TROUBLE SHOOTING	EN-29
ONE YEAR LIMITED WARRANTY	EN-30



NOTE

BEFORE OPERATING THIS PRODUCT, READ, UNDERSTAND, AND FOLLOW THESE INSTRUCTIONS.
BE SURE TO SAVE THIS BOOKLIST FOR FUTURE REFERENCE

IMPORTANT SAFETY INSTRUCTIONS WARNING

**SAFETY WARNING**

To reduce the risk of burns, electric shock, fire, injury to persons or exposure to excessive microwave oven energy when using your appliance, follow basic safety precautions, including the following:

1. Read all instructions before using the appliance.
2. Read and follow the specific: "PRECAUTIONS TO AVOID POSSIBLE EXPOSURE TO EXCESSIVE MICROWAVE ENERGY" found on page 6.
3. This appliance must be grounded. only to properly grounded outlet. See "GROUNDING INSTRUCTIONS" found on page 7.
4. Install or locate this appliance only in accordance with the provided installation instructions.
5. Some products such as whole eggs and sealed containers - for example, closed glass jars - are able to explode and should not be heated in this oven.
6. Use this appliance only for its intended use as described in the manual. Do not use corrosive chemicals or vapors in this appliance. This type of oven is specifically designed to heat, cook or dry food. It is not designed for industrial or laboratory use.
7. As with any appliance, close supervision is necessary when used by children.
8. Do not operate this appliance if it has a damaged cord or plug, if it is not working properly, or if it has been damaged or dropped.
9. This appliance should be serviced only by qualified service personnel. Contact nearest authorized service facility for examination, repair, or adjustment.

IMPORTANT SAFETY INSTRUCTIONS WARNING



SAFETY WARNING

10. Do not cover or block any openings on the appliance.
11. Do not store this appliance outdoors. Do not use this product near water - for example, near a kitchen sink, in a wet basement, near a swimming pool, or similar location.
12. Do not immerse cord or plug in water.
13. Keep cord away from heated surface.
14. Do not let cord hang over edge of table or counter.
15. When cleaning surfaces of door and oven that comes together on closing the door, use only mild, nonabrasive soaps, or detergent applied with a sponge or soft cloth.
16. To reduce the risk of fire in the oven cavity:
 - 1). Do not overcook food. Carefully attend appliance when paper, plastic, or other combustible materials are placed inside the oven to facilitate cooking.
 - 2). Remove wire twist-ties from paper or plastic bag before placing bag in oven.
 - 3). If material inside of the oven ignites, keep oven door closed, turn oven off, and disconnect the power cord, or shut off power at the fuse or circuit breaker panel.
 - 4). Do not use the cavity for storage purposes. Do not leave paper products, cooking utensils, or food in the cavity when not in use.

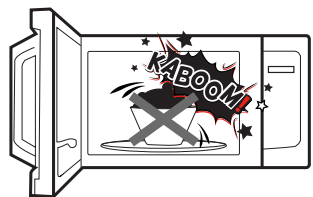

IMPORTANT SAFETY INSTRUCTIONS WARNING



SAFETY WARNING

17. Liquids, such as water, coffee, or tea are able to be overheated beyond the boiling point without appearing to be boiling. Visible bubbling or boiling when the container is removed from the microwave oven is not always present.
THIS COULD RESULT IN VERY HOT LIQUID SUDDENLY BOILING OVER WHEN THE CONTAINER IS DISTURBED OR A UTEBSUK IS INSERTED INTO THE LIQUID.
To reduce the risk of injury to persons:
- 1) Do not overheat the liquid.
 - 2) Stir the liquid both before and halfway through heating it.
 - 3) Do not use straight-sided containers with narrow necks.
 - 4) After heating, allow the container to stand in the microwave oven for a short time before removing the container.
 - 5) Use extreme care when inserting a spoon or other utensil into the container.
18. Oversized food or oversized metal utensils should not be inserted in a microwave/toaster oven as they may create a fire or risk of electric shock.
19. Do not clean with metal scouring pads. Pieces can burn off the pad and touch electrical parts involving a risk of electric shock.
20. Do not use paper products when appliance is operated in the toaster mode.
21. Do not store any materials, other than manufacturer's recommended accessories, in this oven when not in use.
22. Do not cover racks or any other part of the oven with metal foil. This will cause over-heating of the oven.

SAVE THESE INSTRUCTIONS

PRECAUTIONS TO AVOID POSSIBLE EXPOSURE TO EXCESSIVE MICROWAVE ENERGY

1. Do not attempt to operate this oven with the door open since this can result in harmful exposure to microwave energy. It is important not to defeat or tamper with the safety interlocks.
2. Do not place any object between the oven front face and the door or allow soil or cleaner residue to accumulate on sealing surfaces.
3. Do not operate the oven if it is damaged. It is particularly important that the oven door closes properly and that there is no damage to the:
 - a. DOOR (bent)
 - b. HINGES AND LATCHES (broken or loosened)
 - c. DOOR SEALS AND SEALING SURFACE
4. The oven should not be adjusted or repaired by anyone except properly qualified service personnel.

SPECIFICATIONS

Model:	EC042A5C-SS
Rated Voltage:	120V~ 60Hz
Rated Input Power(Microwave):	1500W
Rated Output Power(Microwave):	1000W
Rated Input Power(Convection):	1750W
Oven Capacity:	1.5 cu.ft.
Turntable Diameter:	Ø13.6 inch
External Dimensions:	21.77X21.50X12.99 inch
Net Weight:	Approx. 44.75 Lbs

GROUNDING INSTRUCTIONS

DANGER

Electric Shock Hazard

Touching some of the internal components can cause serious personal injury or death.

Do not disassemble this appliance.

This appliance must be grounded. In the event of an electrical short circuit, grounding reduces the risk of electric shock by providing an escape wire for the electric current. To protect against electrical shock, this appliance is equipped with a cord having a 3 prong grounding-type plug for insertion into a proper grounding-type receptacle. DO NOT alter the plug for use in a 2-prong receptacle. If the plug will not fit into a receptacle, have the proper receptacle installed by a qualified electrician.

CAUTION:

Do not insert your fingers into any gaps or holes; it may cause injuries.

WARNING

Improper use of the grounding can result in a risk of electric shock

Three-pronged
(grounding) plug



GROUNDING INSTRUCTIONS

Consult a qualified electrician or serviceman if the grounding instructions are not completely understood or if doubt exists as to whether the appliance is properly grounded. If it is necessary to use an extension cord, use only a 3-wire extension cord that has a 3-pronged grounding plug, and a 3-slot receptacle that will accept the plug on the appliance. The marked rating of the extension cord shall be equal to or greater than the electrical rating of the appliance.

1. A short power-supply cord is provided to reduce the risks resulting from becoming entangled in or tripping over a longer cord.
2. Longer cord sets or extension cords are available and may be used if care is exercised in their use.
3. If a long cord sets or extension cord is used:
 - a. The marked electrical rating of the cord set or extension marked electrical rating of the cord set or extension cord should be at least as great as the electrical rating of the appliance.
 - b. The extension cord must be a grounding -type 3-wire cord.
 - c. The longer cord should be arranged so that it will not drape over the countertop or tabletop where it can be pulled on by children or tripped over unintentionally.

GROUNDING INSTRUCTIONS

RADIO INTERFERENCE

Operation of the microwave oven may cause interference to your radio, TV or similar equipment.

When there is interference, it may be reduced or eliminated by taking the following measures:

- a. Clean door and sealing surface of the oven.
- b. Reorient the receiving antenna of radio or television.
- c. Relocate the microwave oven with respect to the receiver.
- d. Move the microwave oven away from the receiver.
- e. Plug the microwave oven into a different outlet so that microwave oven and receiver are on different branch circuits.

GROUNDING INSTRUCTIONS

UTENSILS

CAUTION

Electric Shock Hazard

Tightly-closed utensils could explode. Closed containers should be opened and plastic pouches should be pierced before cooking.

See the instructions on "Materials you can use in microwave oven or to be avoided in microwave oven." There may be certain non-metallic utensils that are not safe to use for microwaving.

If in doubt, you can test the utensil in question following the procedure below.

SAVE THESE INSTRUCTIONS HOUSEHOLD INDOOR USE ONLY

UTENSIL TEST:

1. Fill a microwave-safe container with 1 cup of cold water (250ml) along with the utensil in question.
2. Cook on maximum power for 1 minute.
3. Carefully feel the utensil. If the empty utensil is warm, do not use it for microwave cooking.
4. Do not exceed 1 minute cooking time.

MATERIALS YOU CAN USE IN MICROWAVE OVEN

UTENSILS	REMARKS
Browning dish	Follow manufacturer's instructions. The bottom of browning dish must be at least 3/16 inch (5mm) above the turntable. Incorrect usage may cause the turntable to break. ✓
Dinnerware	Microwave-safe only. Follow manufacturer's instructions. Do not use cracked or chipped dishes. ✓
Glass jars	Always remove lid. Use only to heat food until just warm. Most glass jars are not heat resistant and may break. ✓
Glassware	Heat-resistant oven glassware only. Make sure there is no metallic trim. Do not use cracked or chipped dishes. ✓
Oven cooking bags	Follow manufacturer's instructions. Do not close with metal tie. Make slits to allow steam to escape. ✓
Paper plates and cups	Use for short-term cooking/warming only. Do not leave oven unattended while cooking. ✓
Paper towels	Use to cover food for reheating and absorbing fat. Use with supervision for a short-term cooking only. ✓
Parchment paper	Use as a cover to prevent splattering or a wrap for steaming. ✓
Plastic	Microwave-safe only. Follow the manufacturer's instructions. Should be labeled "Microwave Safe". Some plastic containers soften, as the food inside gets hot. "Boiling bags" and tightly closed plastic bags should be slit, pierced or vented as directed by package. ✓
Plastic wrap	Microwave-safe only. Use to cover food during cooking to retain moisture. Do not allow plastic wrap to touch food. ✓
Thermometers	Microwave-safe only (meat and candy thermometers). ✓
Wax paper	Use as a cover to prevent splattering and retain moisture. ✓

MATERIALS TO BE AVOIDED IN MICROWAVE OVEN

UTENSILS	REMARKS	
Aluminum tray	May cause arcing. Transfer food into microwave-safe dish.	✗
Food carton with metal handle	May cause arcing. Transfer food into microwave-safe dish.	✗
Metal twist ties	May cause arcing and could cause a fire in the oven.	✗
Paper bags	May cause a fire in the oven.	✗
Plastic foam	Plastic foam may melt or contaminate the liquid inside when exposed to high temperature.	✗
Wood	Wood will dry out when used in the microwave oven and may split or crack.	✗

SETTING UP YOUR OVEN

NAMES OF OVEN PARTS AND ACCESSORIES

Remove the oven and all materials from the carton and oven cavity.

Your oven comes with the following accessories:

Glass tray	1
Turntable ring assembly	1
Instruction Manual	1

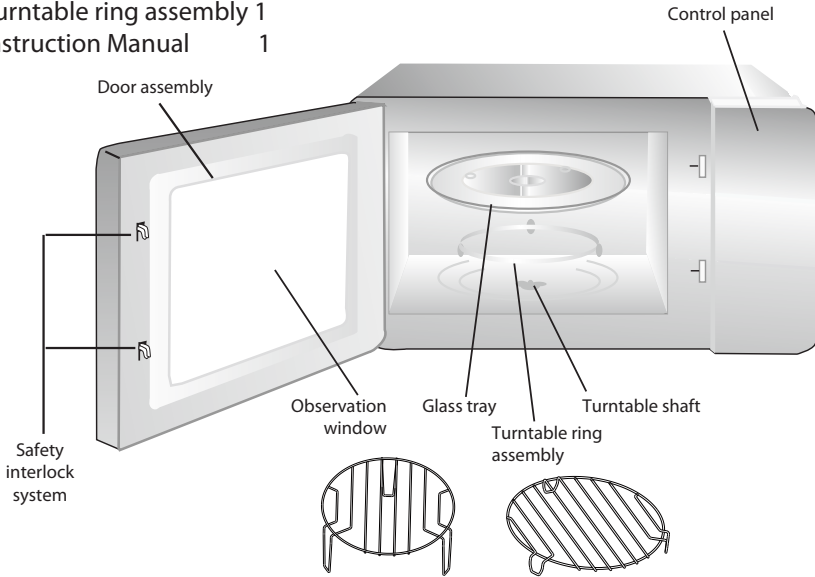

Grill Rack (Only be used in Convectionfunction and be placed on the glass tray)

TURNTABLE INSTALLATION

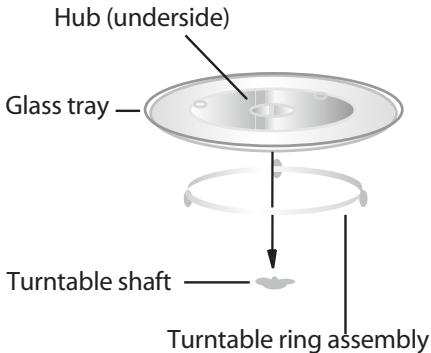

- Never place the glass tray upside down. The glass tray should never be restricted.
- Both glass tray and turntable ring must always be used during cooking.
- All food and containers of food are always placed on the glass tray for cooking.

SETTING UP YOUR OVEN

COUNTERTOP INSTALLATION

Remove all packing material and accessories. Examine the oven for any damage such as dents or broken door. Do not install if oven is damaged.

Cabinet: Remove any protective film found on the microwave oven cabinet surface. Do not remove the light brown Mica cover that is attached to the oven cavity to protect the magnetron.

INSTALLATION

1. Select a level surface that provide enough open space for the intake and/or outlet vents.

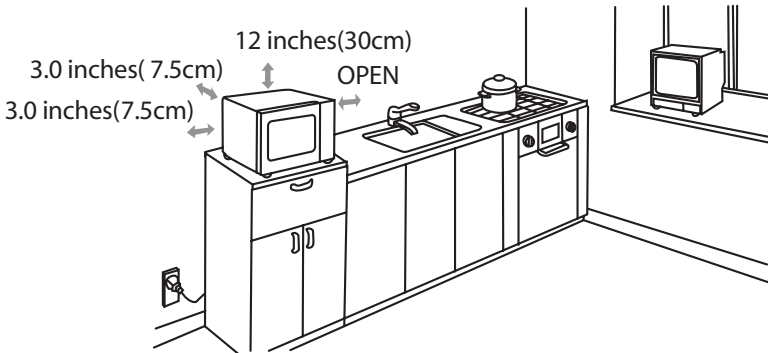

A minimum clearance of 3.0 inches (7.5cm) is required between the oven and any adjacent walls. One side must be open.

- a. Leave a minimum clearance of 12 inches (30cm) above the oven.
- b. Do not remove the legs from the bottom of the oven.
- c. Blocking the intake and/or outlet openings can damage the oven.
- d. Place the oven as far away from radios and TV as possible.
Operation of microwave oven may cause interference to your radio or TV reception.

SETTING UP YOUR OVEN

2. Plug your oven into a standard household outlet. Be sure the voltage and the frequency is the same as the voltage and the frequency on the rating label.



WARNING

Do not install oven over a range cooktop or other heat-producing appliance. If installed near or over a heat source, the oven could be damaged and the warranty would be void.



The accessible surface may be hot during operation.

OPERATION

CONTROL PANEL AND FEATURES



OPERATION

1. POWER LEVEL

Ten power levels are available.

Press Micro, "00:00" will display, then press number pads.

Press Power Level and "PL10" will display. Then press number pads to select a different power level.

In cooking state of microwave, press "Power Level", the current power will be displayed for 3 seconds.

Example : To cook the food with 50% microwave power for 15 minutes.

- Press Micro, "00:00" will display.
- Press "1, 5, 0, 0" in order for 15:00 to appear in the display.
- Press Power Level, then press "5" to select 50% microwave power.
- Press  to start cooking. Buzzer sounds once. The remaining cooking time will display.

Level	10	9	8	7	6	5	4	3	2	1
Power	100%	90%	80%	70%	60%	50%	40%	30%	20%	10%
Display	PL10	PL9	PL8	PL7	PL6	PL5	PL4	PL3	PL2	PL1

2. CLOCK SETTING

When the microwave oven is plugged into an outlet, "0:00" will display.

- Press Timer/Clock twice, "00:00" will appear in the display. The first set of zeros will flash; ":" and the other zero set will be lighted.
- Press the number pads to enter the current clock time. For example, if the time is now 10:12, press "1, 0, 1, 2" in order.
- Press Timer/Clock to finish clock setting, ":" will flash and the numbers will appear as a clock time in the display.

NOTE

- If the numbers entered are not within the range between 1:00 to 12:59, the setting will not be accepted until valid numbers are entered.
- In the process of setting clock, if the  pad is pressed or if there is no operation within 1 minute, the display will automatically return to the previous clock setting.

OPERATION

3. KITCHEN TIMER

- a. Press Timer/Clock once, "00:00" and "Timer" will appear in the display.
- b. Press the number pads to enter the time amount. The maximum amount of time that can be entered is 99 minutes, 99 seconds.
- c. Press **START** /+30Sec to confirm setting, the timer indicator will flash, and the timer will start to count down.
- d. When the time amount elapses, timer indicator will disappear. The oven will beep 5 times. "End" will display. The time of day will display by opening the door or pressing **STOP** /Cancel.

NOTE

- The Kitchen Timer setting is different from the Clock setting; it is simply a timer.
- During the Kitchen Timer function, no cooking function can be set into operation.
- Kitchen Timer amount cannot be increased by pressing **START** /+30Sec.
- Pressing **STOP** /Cancel will cancel the Timer countdown.

4. MICROWAVE COOK

- a. Press Micro, "00:00" and "Cook" will appear in the display.
- b. Press number pads to enter the cooking time. The maximum cooking time is 99 minutes, 99 seconds.
- c. Press Power Level; PL10 will flash. Press Power Level several times or pads 0 through 9 to select a different power level if desired. See the POWER LEVEL table above.
- d. Press **START** /+30Sec to start cooking. The remaining cooking time will display. "Cook" will flash.

Example: To cook the food with 50% microwave power for 15 minutes.

- a. Press Micro, "00:00" and "Cook" will display.
- b. Press "1, 5, 0, 0" in order for 15:00 to appear in the display.
- c. Press Power Level, then press "5" to select 50% microwave power.
- d. Press **START** /+30Sec to start cooking. Buzzer sounds once. The remaining cooking time will display. "Cook" will flash.

NOTE

- In the process of setting, if the **STOP** /Cancel pad is pressed or if there is no operation within 1 minute, the oven will automatically return to display the clock.

OPERATION

5. CONVECTION COOK

- Press Conv. once, "350" will flash. "Conv.", "F" and corresponding temperature icons will display.
- Press Conv. more times or press More or Less to choose the desired cooking temperature. Temperature selections (°100 F): 170, 250, 275, 300, 325, 350, 375, 400, 425. Press **START** /+30Sec to confirm.
- Press **START** /+30Sec to start preheating. When the oven preheats to the selected cooking temperature, it will beep twice; open the door and place food in oven.
- Press number pads to enter the cooking time. The maximum cooking time is 99 minutes, 99 seconds. "F" will disappear.
- Press **START** /+30Sec to start cooking. The remaining cook time will display. "Conv." and corresponding temperature icons will flash.

NOTE

- If no preheat needed, skip step 3 above.
- If preheating, do not place food into oven until cooking temperature is reached.
- If Convection Cooking without preheating, place food into oven at the start of cooking.
- Once the oven preheats to the selected cooking temperature, the oven will beep twice to remind you to enter the cook time, and the temperature will flash. If no operation in 5 minutes, the oven will beep 5 times and return to display the clock.
- The oven must preheat to the selected cooking temperature, and the oven door must be opened before convection cooking time can be entered.

6. COMBINATION FUNCTION (CONVECTION + MICROWAVE)

- Press Combi, "350" will flash. "Cook", "Conv.", "F" and corresponding temperature icons will display.
- Press Combi more times or press More or Less to choose the cooking temperature. Temperature selections (° F): 170, 250, 275, 300, 325, 350, 375. Press **START** /+30Sec to confirm.
- Press number pads to enter the cooking time. The maximum cooking time is 99 minutes, 99 seconds. "F" will disappear.
- Press **START** /+30Sec to start cooking. The remaining cook time will display. "Conv." and corresponding temperature icons will flash.

OPERATION

7. WARM HOLD FUNCTION

- a. Press Warm Hold, "Hold" will display.
- b. Press **START** /+30Sec. to start cooking. The remaining defrost time will count down from 99 minutes.

NOTE

- Warm Hold function can be entered after cooking. The oven will beep twice to denote entering Warm Hold function.
- Warm Hold function can be used after Microwave cook, Convection cook, Combination cook, Defrost cook and Multi-stage cooking.
- The maximum cook time of Warm Hold function is 99 minutes.
- Cooking will be canceled if you open the door or press **STOP** /Cancel during Warm Hold function.

8. ONE TOUCH START

- a. Instant cooking at 100% power level and 1 to 6 minutes cooking time can be started by pressing number pads 1 to 6. Press **START** /+30Sec. to increase the cooking time by 30 seconds with each press. The maximum cooking time is 99 minutes, 99 seconds. Instant cooking at 100% power level and 30 seconds cooking time can be started by pressing **START** /+30Sec.. Each repeated press will increase cooking time by 30 seconds.
- b. The maximum cooking time is 99 minutes, 99 seconds.
- c. During cooking, press More or Less pad to increase or decrease cooking time by 10 seconds.

NOTE

- Time can also be added in 30 seconds increments by pressing **START** /+30Sec. during Microwave Cooking, Time Defrost and Multi-stage Cooking.
- Time cannot be added by pressing **START** /+30Sec. during Weight Defrost and Kitchen Timer functions.

OPERATION

9. TIME DEFROST

- Press Time Defrost , "00:00", "Cook" and "DEF." will appear in the display.
- Press the number pads to input the defrost time.
- Press **START** 7+30Sec. to start defrosting. "Cook" and "DEF." will flash, and the remaining defrost time will display.

10. AUTO DEFROST FUNCTION

- Press Auto Defrost , "dEF1", "Cook" and "DEF." will appear in the display.
- Press Auto Defrost more times or press More / Less pad to choose the defrost food type, "dEF1" through "dEF4". See table below.

LED display	dEF1	dEF2	dEF3	dEF4
Food	Meat	Poultry	Fish	Bread
Weight	0.1-6.0 Lbs	0.1-6.0 Lbs	0.1-6.0 Lbs	0.1-1.0 Lbs

- Press number pads to enter the weight to be defrosted. See table above. If the weight input is not between the weight range listed on the table above, the input will be invalid. The unit will not work until valid numbers are entered.
- Press **START** 7+30Sec. to start defrosting and the remaining cooking time will be displayed. "Cook" and "DEF." indicator will flash.

NOTE

- During cooking of meat, poultry and Fish, the oven will beep twice to remind you to turn over the food.
- Open the door to pause operation. Turn over food, close the door and press **START** 7+30Sec. to resume defrost cycle. If you do not open door to pause operation, the oven will continue the defrost cycle without interruption.

OPERATION

11. AUTO BAKE FUNCTION

- a. Press Auto Bake, "Ab-1", "Cook", "Conv." and "Auto" will display.
- b. Press Auto Bake more times to choose the menu, "Ab-1" though "Ab-4". See Auto Bake Chart below.
- c. For Ab-1, Ab-2 and Ab-3, press number pad 1 to choose the default weight or portion. Press **START** /+30sec. to start cooking.
For Ab-4, press number pads to adjust the portion or weight. Press **START** /+30sec. to start cooking. The remaining cooking time and corresponding temperature icons will display. "Conv." and "Auto" will flash.

AUTO BAKE CHART:

Food	Display	Weight/Portion	Recommended grill
Frozen Pizza	Ab-1	10 oz	Higher grill rack
Muffins	Ab-2	6 each	Lower grill rack
Biscuit/DinnerRoll/Bread Stick	Ab-3	7 oz	Higher grill rack
Frozen French Fries	Ab-4	4-10 oz	Higher grill rack

12. AUTO ROAST FUNCTION

- a. Press Auto Roast, "Ar-1", "Cook", "Conv." and "Auto" will display.
- b. Press more times to choose the menu, "Ar-1" through "Ar-4". See Auto Roast Chart Auto Roast below.
- c. Press number pads to adjust the weight or portion.
- d. Press **START** /+30sec. to start cooking. The remaining cooking time and corresponding temperature icons will display. "Cook", "Conv." and "Auto" will flash.

AUTO BAKE CHART:

Food	Display	Weight/Portion	Recommended grill
Beef	Ar-1	2.0-4.0 Lbs	Lower grill rack
Whole Chicken	Ar-2	2.5-6.0 Lbs	Lower grill rack
Turkey Breasts	Ar-3	3.0-6.0 Lbs	Lower grill rack
Pork	Ar-4	2.0-4.0 Lbs	Lower grill rack

OPERATION

13. SENSOR COOK

- Press Sensor Cook, "SC-1", "SEN." and "Auto" will display.
- Press Sensor Cook more times or press number pads to choose the type of food.
- Press  to start cooking. "SC-", "SEN." and "Auto" will flash. Once the item has been sensed, the remaining cooking time will display. "SEN.", "Cook" and "Auto" will flash.

Auto Bake Chart:

Food	Display	Pad	Weight/Portion
Potato	SC-1	1	1-4 PCS (8-10 oz/PCS)
Fresh Vegetable	SC-2	2	1-4 CUP (250 ml/cup)
Frozen Vegetable	SC-3	3	1-4 CUP (250 ml/cup)
Frozen Entree	SC-4	4	10-20 oz
Rice	SC-5	5	1-2 CUP(220 g/cup)
Casserole	SC-6	6	1-4 CUP(250 ml/cup)
Ground Meat	SC-7	7	4-32 oz
Fish/Seafood	SC-8	8	4-32 oz
Scrambled Eggs	SC-9	9	2-5 each
Frozen Pizza	SC-0	0	6-12 oz

OPERATION

14. SENSOR REHEAT

- a. Press Sensor Reheat , "Sr-1" , "SEN." and "Auto" will display.
- b. Press Sensor Reheat more times or press number pads 1 through 3 to choose the type of food.
- c. Press **START** /+30Sec. to start cooking. "Sr-" , "SEN." and "Auto" will flash. Once the item has been sensed, the remaining cooking time will flash. "SEN." , "Cook" and "Auto" will flash.

Auto Bake Chart:

Food	Display	Weight/Portion
Dinner Plate	Sr-1	8-24 oz
Soup/Sauce	Sr-2	1-4 CUP (250 ml/cup)
Casserole	Sr-3	1-4 CUP (250 ml/cup)

15. POPCORN

- a. Press Popcorn , "1.75" , "Auto" , "Cook" and "Oz" will appear in the display.
- b. Press Popcorn two more times or press More or Less to choose the weight, "3.0" and "3.5" will display in order.
- c. Press **START** /+30Sec. to cook. "Oz" disappears. "Auto" and "Cook" will flash. The remaining time will display.

OPERATION

16. FAVORITE FUNCTION

- a. Press Favorite to program and choose up to three cooking procedures. Each procedure will be indicated by 1, 2 or 3 in the display.
- b. Press Favorite until your desired procedure number appears in the display. Press **START** /+30Sec. to begin it. A maximum of two cooking stages can be set for each procedure.
- c. To program a procedure, follow the steps listed below.
Example: Cook food at 80% Power Level for 3 minutes and 20 seconds; save as memory 2.
 - (a) Press Favorite twice; screen displays 2.
 - (b) Press Micro , then press "3" , "2" and "0" in order.
 - (c) Press Power Level once, then press "8" for "PL 8" to display.
 - (d) Press Favorite to save the procedure. Oven beeps once.
Or press **START** /+30Sec. directly to save and start cooking.
 - (e) To choose the procedure from the memory list, press Favorite twice. Screen will display "2". Press **START** /+30Sec. to run procedure.

NOTE • Auto Menu cannot be set in Favorite function.

OPERATION

17.MUTI-STAGE COOKING

At most 2 stages can be set for cooking. If one stage is Defrost, it will automatically set to be the first stage.

NOTE • Auto Menu and Preheat cannot be set in Multi-stage Cooking.

EXAMPLE: 80% Power Level for 5 minutes followed by 60% Power Level for 10 minutes; saved as memory 3.

- a. Press Favorite 3 times; screen displays 3.
- b. Press Micro, then press "5" , "0" and "0" to set first stage cook time.
- c. Press Power Level once, then press "8" to choose 80% first stage cooking power.
- d. Press Micro again, then press "1" , "0" , "0" and "0" to set second stage cook time.
- e. Press Power Level again, then press "6" to choose 60% second stage cooking power.
- f. Press **START** /+30Sec. to immediately start multi-stage cooking.
- g. To choose the procedure from the memory list, press Favorite three times. Screen will display "3"; press **START** /+30Sec. to run procedure.

NOTE • If you do not want to save a particular multi-stage program as a procedure, do not press Favorite as the first step. Press **START** /+30Sec. after programming both stages.

18.INQUIRING FUNCTION

- a. When oven is cooking, press Timer/Clock for the time of day to appear for three seconds in the display.
- b. When oven is cooking, press Conv., Power Level or Combi pads for cooking power to appear for three seconds in the display.

OPERATION

19. TURN ON/OFF THE BUZZER SOUND



It is default that the buzzer sounds is open. In waiting state, long pressing on number 8 for 3 seconds, it sounds a long beep, turns off the sound.

When the sounds turn off, long pressing on 8 for 3 seconds, it sounds a long beep and the sound turn off. All the buttons has no beep when they are pressed, including the ending cooking sounds is turn off too.



NOTE

- All models has mute function and energy-saved function. This function can work under lock function too.

20.ENERGY SAVER MODE

- In standby mode, press the "  " once (less than 3 seconds to avoid starting the child lock function to enter the Energy Saver mode.
- In child-locked mode, press the "  " once (less than 3 seconds) and release to enter the Energy Saver Mode.
- Above operation is the only way to start the Energy Saver mode.
- The Energy Saver mode works only if the door is closed.

21.LOCK FUNCTION

- To lock the microwave so that it cannot be operated by children or other unintended users, pres  pad for 3 seconds. You will hear a long beep. "LOC" will display.
- To unlock, press  for 3 seconds, you will hear a long beep and "LOC" will disappear.
If the clock has been set, the oven will return to display the clock. Otherwise, "0:00" will display.

OPERATION

22. COOKING END REMINDER FUNCTION

The oven will beep five times to alert the user that cooking time has ended. "End" will display. The time of day will display by opening the door or pressing  pad.

23. OTHER SPECIFICATIONS

- a.  must be pressed to continue cooking if the door is opened during cooking.
- b. A single beep sounds to indicate that a pad is correctly pressed; if pad is not correctly pressed, no beep sounds.

24. TURNTABLE RESET FUNCTION

- a. When cooking finished, if the turntable is not at the initial position, it will enter the turntable reset function. At this time, the lamp, fan and turntable are working, "E - - J" will dynamic display. After the turntable has reset, the oven stops cooking and reminds cooking finished.
- b. In waiting state, press number key "5" for 3 seconds, there will be a long "beep" denoting turntable reset function is turned off. To turn on the turntable reset function, in waiting state press number key "5" for 3 seconds, there will be a long "beep" denoting that turntable reset function is released.

NOTE

- This function only works for one completed cooking. If pause or open the oven door during cooking, the current cooking cannot enter the turntable reset function.
- Under the reset state, opening the door or "" button is pressed, the oven will go back to waiting state.

TROUBLE SHOOTING

Check your problem by using the chart below and try the solutions for each problem.

TROUBLE	Possible Cause	Possible Remedy
Oven will not start	<ul style="list-style-type: none"> a. Electrical cord for oven is not plugged in. b. Door is open. c. Wrong operation is set. 	<ul style="list-style-type: none"> a. Plug into the outlet. b. Close the door and try again. c. Check instructions
Arcing or sparking	<ul style="list-style-type: none"> a. Materials to be avoided in microwave oven were used. b. The oven is operated when empty. c. Spilled food remains in the cavity. 	<ul style="list-style-type: none"> a. Use microwave-safe cookware only. b. Do not operate with oven empty. Clean c. cavity with wet towel.
Unevenly cooked foods	<ul style="list-style-type: none"> a. Materials to be avoided in microwave oven were used. b. Food is not defrosted completely. c. Cooking time, power level is not suitable. d. Food is not turned or stirred. 	<ul style="list-style-type: none"> a. Use microwave-safe cookware only. b. Completely defrost food. c. Use correct cooking time, power level. d. Turn or stir food.
Overcooked foods	Cooking time, power level is not suitable.	Use correct cooking time, power level.
Undercooked foods	<ul style="list-style-type: none"> a. Materials to be avoided in microwave oven were used. b. Food is not defrosted completely. c. Oven ventilation ports are restricted. d. Cooking time, power level is not suitable. 	<ul style="list-style-type: none"> a. Use microwave-safe cookware only. b. Completely defrost food. c. Check to see that oven ventilation ports are not restricted. d. Use correct cooking time, power level
Improper defrosting	<ul style="list-style-type: none"> a. Materials to be avoided in microwave oven were used. b. Cooking time, power level is not suitable. c. Food is not turned or stirred. 	<ul style="list-style-type: none"> a. Use microwave-safe cookware only. b. Use correct cooking time, power level. c. Turn or stir food
Sensor cooked foods not properly cooked	<ul style="list-style-type: none"> a. Cover or lid on food not vented. b. Door opened before sensor-detected cooking time appears in display. 	<ul style="list-style-type: none"> a. Cover or lid over food must contain vent hole for escaping steam. b. Do not open door to stir or turn food before sensor-detected cooking time appears in display.

ONE YEAR LIMITED WARRANTY

This product carries a warranty stating that it will be free from defects in material and workmanship for a period of one year from the date of purchase. This warranty is valid for the original retail purchaser from the date of initial retail purchase and is not transferable. Keep your original sales receipt.

IMPORTANT:

1. This warranty does not cover damages resulting from accident, misuse or abuse, lack of reasonable care, the affixing of any attachments not provided with the product, loss of parts, or subjecting the appliance to any but the specified voltage. (Read directions carefully.)
2. This warranty is void if this product is ever used for other than private household purposes.
3. This warranty is void if this product is ever used outside of United State.

If service is required during the warranty period, properly pack your unit. We recommend using the original carton and packing materials.

If additional assistance is needed, please contact customer assistance at:

customercare@us.toshiba-lifestyle.com
855-204-5313
Midea America Corp
5 Sylvan Way,
Parsippany, NJ 07054

Midea America Corp. expressly disclaims all responsibility for consequential damages or incidental losses caused by use of the appliance. Some states do not allow this exclusion or limitation of incidental or consequential losses so the foregoing disclaimer may not apply to you. This warranty gives you specific legal rights, and you may also have other rights which may vary from state to state.

The serial number can be found on the back cabinet. We suggest that you record the serial number of your unit in the space below for future reference

Model Number: _____

Serial Number: _____

SAVE THIS FOR YOUR RECORDS

Made in China

PN:16170000A79462

Customer Assistance: 855-204-5313

Midea America Corp

5 Sylvan Way, Parsippany, NJ 07054