



INSP-3
Wiring Inspection
Tester

Users Manual

- Mode d'emploi
- Bedienungshandbuch
- Manual d'Uso
- Manual de uso



INSP-3

Wiring Inspection Tester

Users Manual

English

December 2009, Rev.1
©2009 Amprobe Test Tools.
All rights reserved. Printed in China

Limited Warranty and Limitation of Liability

Your Amprobe product will be free from defects in material and workmanship for 1 year from the date of purchase. This warranty does not cover fuses, disposable batteries or damage from accident, neglect, misuse, alteration, contamination, or abnormal conditions of operation or handling. Resellers are not authorized to extend any other warranty on Amprobe's behalf. To obtain service during the warranty period, return the product with proof of purchase to an authorized Amprobe Test Tools Service Center or to an Amprobe dealer or distributor. See Repair Section for details. THIS WARRANTY IS YOUR ONLY REMEDY. ALL OTHER WARRANTIES - WHETHER EXPRESS, IMPLIED OR STATUTORY - INCLUDING IMPLIED WARRANTIES OF FITNESS FOR A PARTICULAR PURPOSE OR MERCHANTABILITY, ARE HEREBY DISCLAIMED. MANUFACTURER SHALL NOT BE LIABLE FOR ANY SPECIAL, INDIRECT, INCIDENTAL OR CONSEQUENTIAL DAMAGES OR LOSSES, ARISING FROM ANY CAUSE OR THEORY. Since some states or countries do not allow the exclusion or limitation of an implied warranty or of incidental or consequential damages, this limitation of liability may not apply to you.

Repair

All test tools returned for warranty or non-warranty repair or for calibration should be accompanied by the following: your name, company's name, address, telephone number, and proof of purchase. Additionally, please include a brief description of the problem or the service requested and include the test leads with the meter. Non-warranty repair or replacement charges should be remitted in the form of a check, a money order, credit card with expiration date, or a purchase order made payable to Amprobe® Test Tools.

In-Warranty Repairs and Replacement – All Countries

Please read the warranty statement and check your battery before requesting repair. During the warranty period any defective test tool can be returned to your Amprobe® Test Tools distributor for an exchange for the same or like product. Please check the "Where to Buy" section on www.amprobe.com for a list of distributors near you. Additionally, in the United

States and Canada In-Warranty repair and replacement units can also be sent to a Amprobe® Test Tools Service Center (see address below).

Non-Warranty Repairs and Replacement – US and Canada

Non-warranty repairs in the United States and Canada should be sent to a Amprobe® Test Tools Service Center. Call Amprobe® Test Tools or inquire at your point of purchase for current repair and replacement rates.

In USA

Amprobe Test Tools

Everett, WA 98203

Tel: 877-AMPROBE (267-7623)

In Canada

Amprobe Test Tools

Mississauga, ON L4Z 1X9

Tel: 905-890-7600

Non-Warranty Repairs and Replacement – Europe

European non-warranty units can be replaced by your Amprobe® Test Tools distributor for a nominal charge. Please check the "Where to Buy" section on www.amprobe.com for a list of distributors near you.

European Correspondence Address*

Amprobe® Test Tools Europe

In den Engematten 14

79286 Glottertal, Germany

Tel.: +49 (0) 7684 8009 - 0

*(Correspondence only – no repair or replacement available from this address. European customers please contact your distributor.)

INSP-3 Wiring Inspection Tester

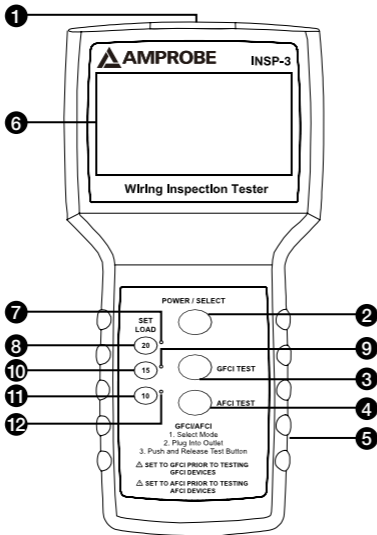















- 1) Power Cord Receptacle
- 2) Power/Select Push button
- 3) GFCI Test Push button
- 4) AFCI Test Push button
- 5) Battery Compartment
- 6) LCD Display
- 7) 20A load LED indicator

- 8) 20A load push button selector
- 9) 15A load LED indicator
- 10) 15A load push button selector
- 11) 10A load push button selector
- 12) 10A load LED indicator

CONTENTS

SYMBOLS	2
UNPACKING AND INSPECTION	4
INTRODUCTION	4
Features	4
OPERATION	6
Main Screen (<i>Refer to Fig.2</i>)	6
Secondary Screen (<i>Refer to Fig.3</i>)	7
What the Readings Mean	8
SPECIFICATION	11
MAINTENANCE AND REPAIR	11
Battery Replacement	12

SYMBOLS

	Battery		Refer to the manual
	Double Insulated		Dangerous Voltage
	Alternating Current		Earth Ground
	Direct Current		Fuse
	Application around and removal from hazardous live conductors is permitted		Complies with EU directives
	Do not dispose of this product as unsorted municipal waste		Conform to relevant Australian standards
	Underwriters Laboratories.[Note: Canadian and US.]		Audible tone

Safety Information

- The INSP-3 wiring inspection Tester is conformed to EN61010-1:2001; CAT II 120 V, class II and pollution deg.2
- Do not exceed the maximum overload limits (see specifications) nor the limits marked on the instrument itself. Never apply more than 120 VAC rms between the adaptor prongs of the wiring inspection tester.

⚠ WARNING and PRECAUTIONS

- Before and after hazardous voltage measurements, test the voltage function on a known source such as line voltage to determine proper meter functioning.
- Inspect the INSP-3 wiring inspection tester before every use. Do not use any damaged part.
- Never ground yourself when taking measurements. Do not touch exposed circuit elements or test probe tips.
- Do not operate the instrument in an explosive atmosphere.
- To reduce the risk of fire or electric shock, do not expose this product to rain or moisture.
- The meter is intended only for indoor use. To avoid electrical shock hazard, observe the proper safety precautions when working with voltages above 60 VDC, 42.4 Vpk, or 30 VAC rms. These voltage levels pose a potential shock hazard to the user.
- Before and after hazardous voltage measurements, test the voltage function on a known source such as line voltage to determine proper meter functioning.
- Keep your hands/fingers behind the hand/finger barriers (of the meter and the power cord) that indicate the limits of safe access of the hand-held part during measurement.

UNPACKING AND INSPECTION

Your shipping carton should include:

- 1 INSP-3 Wiring Inspection Tester
- 1 Power Cord
- 1 9V Alkaline Battery (Installed)
- 1 Users Manual
- 1 Carrying Case

If any of the items are damaged or missing, return the complete package to the place of purchase for an exchange.

INTRODUCTION

The INSP-3, wiring inspector is a rugged tester designed to verify building wiring compliance to electrical code, especially voltage drop under load. Identify issues with splices, connections and conductor quality, crucial to safety and performance of the electrical system.

Features

- Testing efficiency - relevant test data (voltage, voltage drop, hot and neutral voltage drop, voltage with load, ground impedance) is presented on a single large display to save operator time - no scrolling or switching screens needed
- Verifies if wiring is tested for load carrying ability that meets electrical code recommendations for voltage drop under load

- Meter detects faulty wiring in need of repair without removing outlets cover plates, or panel covers:
- Faulty splices and connections
- Incorrect wiring
- Undersized wiring
- Faulty GFCIs,
- Faulty or incorrectly wired AFCIs
- Incorrect line voltage
- Poor ground quality
- User selectable 10,15 and 20 amps loads to verify performance of the electrical system
- Incorrect wiring or voltage drop test failure is clearly indicated by flashing screen
- Will not trip circuit breakers or blow fuses during the test
- Tests GFCI and AFCI operations
- Check ground quality for safety and ability to support sensitive electronic equipment
- Measure fault currents
- Save money and time by eliminating guess work.

NOTE: The Inspector™ 3 does not check the condition of wiring insulation.

OPERATION

A High Quality Adaptor should be used when testing 2 wire outlets.

Ground impedance and polarity is not tested on 2 wire outlets.

1. Push GFCI TEST push button or AFCI TEST push button before plugging the INSP-3 to a GFCI or AFCI circuit outlet to be tested.
2. Plug the INSP-3 wiring inspection tester into an energized 120V wall outlet using the power cord provided. Refer to Fig.1
3. The unit will turn itself ON and display the test results.
4. Push the desired Set Load push button.
Although 10 AMP outlets don't exist, the switch may be set to 10 simulating a light load if a small, lower current device will be connected to the line. Typical 2 wire, 15 AMP and 20 AMP outlets appear as follows:

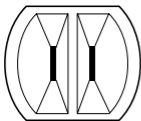

2 WIRE

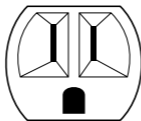

15 AMP

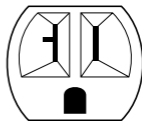

20 AMP

5. Read the test results. For GFCI and AFCI, refer to fig.4 and fig.5

Main Screen (Refer to Fig.2)

Line 1: shows an unloaded voltage of 121.5V / 60Hz at the outlet being tested.

Line 2: shows the polarity status

Line 3: The "SET LOAD" switch is set for a test drawing 15 amps. At 15 amps of current draw, the voltage at the outlet would drop by 4.2%. Since 4.2% is lower than the NEC recommendation of a maximum of 5% drop, it would not be flashing.

Line 4: shows that 1.1% of the voltage drop is on the hot conductor while 3.1% is on the neutral conductor.

Line 5: shows that the voltage at the outlet would drop to 116.4 volts with a 15 amp load applied.

Line 6: shows that the resistance of the ground conductor from the outlet to the point where it is bonded to the neutral conductor is .27 ohms.

NOTE: The Set Load switch may be changed to show what the drops and voltage would be at 10, 15, or 20 Amps any time after the first reading is indicated.

Secondary Screen *(Refer to Fig.3)*

Line 1: shows the outlet to have a true rms voltage of 121.5/60 Hz volts with no load applied by The Inspector-3.

Line2: shows the polarity status

Line 3: shows the common mode (the voltage difference between the ground and neutral conductor) to be 0.79 volts with no load applied by the Inspector-3.

Line 4: shows that if the hot and neutral conductors were to be shorted at the outlet,

the wiring resistance would limit the current to approximately 424 Amps.

Line 5: shows that if the hot and ground conductors were to be shorted at the outlet, the wiring resistance would limit the current to approximately 850 Amps.

NOTE: Unit turns on automatically when plugged in. Push and release Power/Select push button to toggle between screens.

What the Readings Mean

A) Voltage under load: This is the actual voltage available if a steady load of 10, 15 or 20 amps is applied to the line. Most North American devices will operate correctly between approximately 110 and 125 volts. Voltage of less than 108 may cause computers and other sensitive equipment to malfunction. High or low voltage can often be corrected by the utility company servicing your area.

B) Voltage Drop: Indicates amount voltage would be reduced with the set load applied to the line. The national electrical code recommends no more than a 5% voltage drop. Excessive voltage drop can be caused by poor splices, connections or too small of wiring for the length of the run. Excessive voltage drop can lead to fire, low operating voltages, and marginal operations of equipment. Individual conductor quality is tested by comparing the percentage of voltage drop on the hot and neutral conductors. This will indicate if either the hot or the neutral has a

loose connection or if the wiring run is too long or has too small a gauge wire for the length of the run. The electrical code states that “. . . where the maximum voltage drop on both feeders and branch circuits to the farthest outlet does not exceed 5 percent, will provide reasonably efficiency of operation” (Sec. 210-19)

Possible problems creating excessive voltage drop:

- a) Bad splice
- b) Loose screw termination
- c) Stripped thread on wire nuts or terminal screws
- d) Faulty outlet
- e) Undersize wiring (too long of run for wire size)
- f) Loose connection at circuit breaker or fuse
- g) Corroded connections
- h) Overheating due to loose contacts
- i) Faulty or poor quality push in connections on receptacles
- j) Cold forming on aluminum wiring, causing loose connections
- k) Worn switch or circuit breaker contacts.

NOTE: 15 amp systems should not be expected to perform to 20 amp specifications

C) Ground Impedance Test – This test is not related to the “set load” switch and is not affected by voltage drop on the line. This test simply tells you the quality of the outlet ground. Most computers

and high technology electronics are reliant on a good quality equipment ground for proper operation. A typical rule of thumb is ground resistance in most cases should be less than 2 ohms. Loose connection, splices or too small of a ground conductor can cause high impedance. If less than .05 ohms is indicated on a medium or long wire run, check the test outlet for a short between neutral and ground.

D) Polarity Test – This test checks for typical wiring errors involving three wire outlets. Any wiring errors should be corrected immediately before further test of the outlet.

NOTE: Open hot is indicated by “No AC present”

Important Notes for Testing GFCI / AFCI Circuits

A) Consult the manufacturer’s installation instructions to determine that the device is installed in accordance with the manufacturer’s specifications.

B) Check for correct wiring of the receptacle and all remotely connected receptacles on the branch circuit.

C) Operate the test button on the installed device. The device must trip. If it does not – do not use the circuit – consult an electrician.

NOTE: A good quality 3 to 2 wire adapter may be used to test ungrounded systems with little loss in accuracy.

Lighting or motor circuits may be tested by using a good quality plug to clip lead adapter having not

smaller than 14 gauge wire and not longer than 4 feet.

Large power disturbances or spikes may cause erratic readings.

SPECIFICATION

Load: Constant 0, 10,15 or 20 AMP simulation regardless of line voltage

Operating Voltage: 95-140V AC

Power: 9V Alkaline Battery

Fuse: ½ Amp, 125V. Not user replaceable.

GFI Trip: 6.0 mA nominal to trip GFI, 30 mA to trip RCD

AFCI Trip: Up to 8, 120 Amp pulses within ½ second period

Operating Temperature: 0°C to 50°C (32°F to 120°F)

Accuracy: +/- 2%, +/- 2 digits.

MAINTENANCE AND REPAIR

If there appears to be a malfunction during the operation of the meter, the following steps should be performed in order to isolate the cause of the problem.

1. Check the battery. Replace the battery immediately when the unit doesn't turn ON.
2. Make sure you use the power cord provided with the unit

3. Review the operating instructions for possible mistakes in operating procedure.

Except for the replacement of the battery, repair of the meter should be performed only by a Factory Authorized Service Center or by other qualified instrument service personnel. The front panel and case can be cleaned with a mild solution of detergent and water. Apply sparingly with a soft cloth and allow to dry completely before using. Do not use aromatic hydrocarbons or chlorinated solvents for cleaning.

Battery Replacement

Power is supplied by 9V Alkaline Battery x1

To replace the battery, remove the screw from the back of the meter and pull the battery door outward.

Remove the battery from case bottom and replace it with a fresh 9V Alkaline battery.

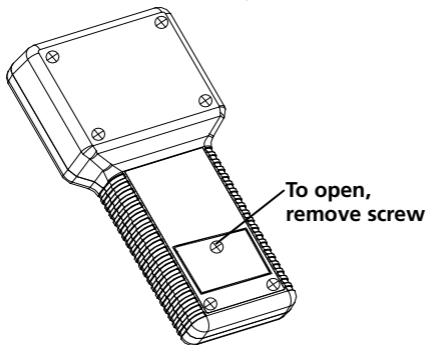

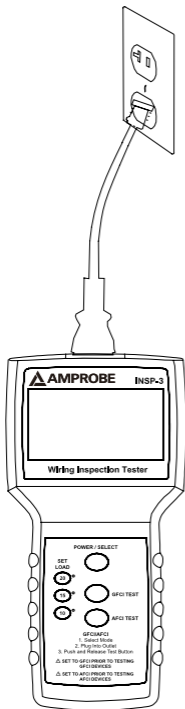

Fig.1

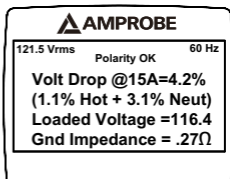

Fig.2

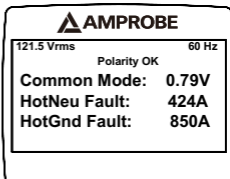

Fig.3

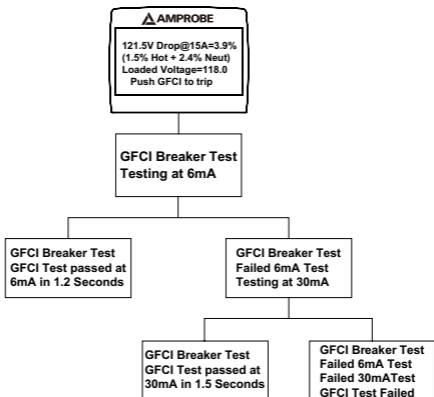

Fig.4

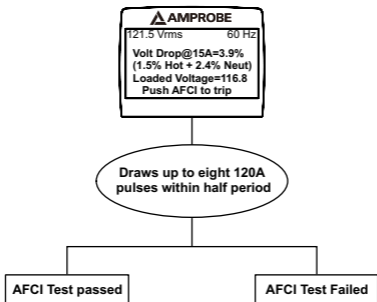

Fig.5

Visit www.Amprobe.com for

- Catalog
- Application notes
- Product specifications
- User manuals



Please Recycle