

# Bonsenkitchen

## Masticating Juicer

Operation Instructions

Model: MJ8901

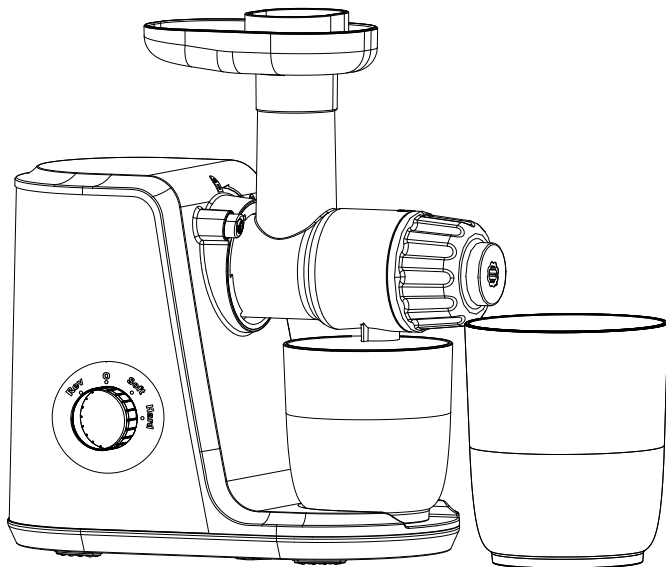

[www.bonsenkitchen.com](http://www.bonsenkitchen.com)



# Contents

IMPORTANT SAFEGUARDS .....	1-3
PACKAGE CONTENTS .....	4
KNOW YOUR MASTICATING JUICER .....	4-5
TECHNICAL DETAILS .....	6
BEFORE USING MASTICATING JUICER .....	6
USING YOUR MASTICATING JUICER .....	7-9
CLEANING AND MAINTENANCE .....	9-10
WARRANTY CLAIM PROCEDURE .....	11
ENVIRONMENT FRIENDLY DISPOSAL .....	11

# IMPORTANT SAFEGUARDS

1. Read all instructions.
2. The input voltage of the appliance is 120V~60Hz. Please confirm it before using the appliance.
3. To disconnect the power supply before dismantling, assembling or adjusting any part of the appliance.
4. Before use, please check if Y connection, the power cord, the plug, the juice strainer, the spiral pusher and any other part is damaged. If any of the said part is damaged, stop using the appliance and contact our customer service department promptly. Do not dismantle and repair it by yourself, otherwise dangers may happen.
5. If it is necessary to repair the appliance during use, please contact our customer service department or have it directly repaired by a service center designated by us. Do not dismantle it by yourself, otherwise dangers may happen.
6. It is necessary before connecting the power supply to ensure that the juicing body, the spiral pusher, the juicing body cap and all other dismountable parts are properly installed.
7. Never put hands or sharp objects into the feed port or contact the spiral pusher when the appliance is running, otherwise injuries may be caused or the appliance may be damaged; never replace the spiral pusher with any other objects or have eyes get close to the feed port, otherwise accidents may happen.
8. Cut food ingredients into small blocks with sizes fitting the feed port of the juicing body. Do not begin to process any vegetables or fruits with cores, hard seeds or thick skin or shells until the cores, hard seeds or thick skin or shells are removed.
9. When feeding a food ingredient, do not make the pushing force too large but have it just enough to cut the food ingredient.
10. Dyeing of the juice strainer, the juicing body cap, the spiral pusher and other accessories after juicing some vegetables or fruits is normal and will neither affect food eating nor do harm to health.

11. Equipped with an intelligent protective chip, the appliance will stop automatically after 20 minutes of continuous running. In this case, wait for 20 to 30 minutes before continuous use until the motor has cooled down to prolong the service life of the appliance.
12. The appliance has a current limiting design, so its motor will get locked and its current will increase when hard food ingredients are processed. When the current is larger than 1.3A, the appliance will tick and the motor will pause for 2 seconds, then reverse automatically for 5 seconds and finally stop running (the food in the appliance can be discharged when the motor reverses). In this case, the appliance can begin to run again after the ON/OFF button is put on the "O" position.
13. If the appliance has current limiting protection or its motor is locked and stops automatically and cannot reverse automatically, switch off the power switch and put it on the "O" position, then press the "ON" button of the power switch to discharge the food ingredients in the appliance and finally press the "R" button of the power switch for normal use of the appliance. If the motor is still locked, it is suggested to remove the food ingredients in the spiral pusher before continue to use the appliance. This measure can protect the motor.
14. Do not dismantle the dismountable parts of the appliance immediately after use but after both the motor and the spiral pusher have stopped and the power supply is disconnected.
15. Do not sterilize any accessories of the appliance with hot water with a temperature higher than 80°C or a microwave oven, otherwise they may be heated, deformed and damaged. The materials of all parts in contact with food ingredients should comply with food hygiene certification and be clean, hygienic and reliable.
16. Do not put the main body into water or another liquid or flush it with water or another liquid, otherwise it may be damaged.
17. Do not clean the appliance with steel wool, abrasive cleaning agents or corrosive liquids (such as gasoline or acetone).
18. Put the appliance at a place unreachable to children. The appliance is not intended for use or play by persons (including children) with reduced physical, sensory or mental capabilities or lack of experience and knowledge.

19. The appliance is applicable to use by individuals or families only.
20. Accessories, other than those supplied with the appliance, include instructions for their safe use.
21. Use a wet cloth to clean surfaces in contact with food before unplug the plug.
22. Switch off the appliance and disconnect from supply before changing accessories or approaching parts that move in use.
23. Portable appliance for household and indoor use only.
24. If the supply cord is damaged, it must be replaced by the manufacturer, its service agent or similarly qualified persons in order to avoid a hazard.
25. This appliance can be used by children aged from 8 years and above and persons with reduced physical, sensory or mental capabilities or lack of experience and knowledge if they have been given supervision or instruction concerning use of the appliance in a safe way and understand the hazards involved. children shall not play with the appliance. cleaning and user maintenance shall not be made by children without supervision.

**WARNING: Potentially dangerous may against misuse.**

27. Always disconnect the appliance from the supply if it is left unattended and before assembling, disassembling and cleaning.
28. This appliance shall not be used by children. Keep the appliance and its cord out of reach of children. This appliance can be used by children aged from 8 years and above if they have been given supervision or instruction concerning use of the appliance in a safe way and if they understand the hazards involved.
29. Cleaning and user maintenance shall not be made by children unless they are aged from 8 years and above and supervised. Keep the appliance and its cord out of reach of children aged less than 8 years.
30. Appliances can be used by persons with reduced physical, sensory or mental capabilities or lack of experience and knowledge if they have been given supervision or instruction concerning use of the appliance in a safe way and if they understand the hazards involved. Children shall not play with the appliance.

# PACKAGE CONTENTS

1 Masticating juicer

1 Cleansing brush

1 Operating Instructions

Check the delivery contents for completeness immediately after unpacking.

Remove all packaging materials and plastic film from the appliance.

# KNOW YOUR MASTICATING JUICER

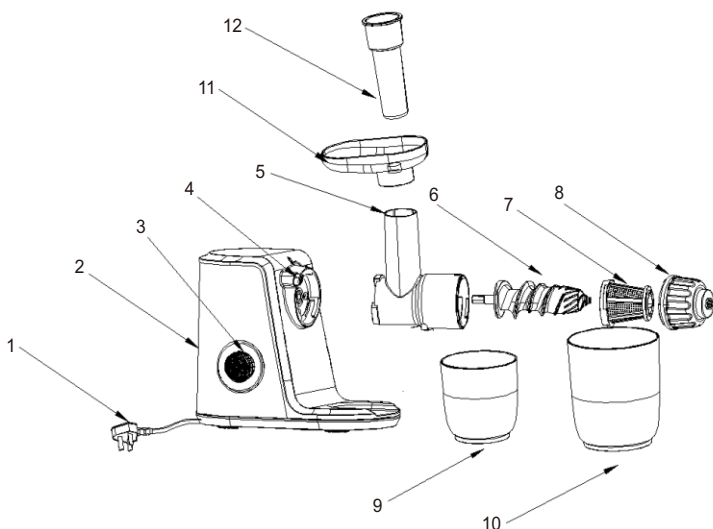

NO.	Part name	Function
1	Power cord	It is used for connecting the power supply to provide power.
2	Main body	As a main part and the power source of the appliance.
3	Power switch	It controls the operating statuses (I, II, 0 and R) of the appliance.

4	Button	It is used for locking the juicing body to prevent it from getting loose from the main body during use.
5	Juicing body	It is a main part for juicing. Food ingredients are first fed via the feed port at the top of the juicing body and then discharged in forms of juice and pulp via the juice outlet and the pulp outlet respectively.
6	Spiral pusher	As a main part for juicing, it is used for conveying food ingredients and grinding them by breaking in with the juice strainer or the squeezer.
7	Juice strainer	By means of breaking in with the spiral pusher, it is used for grinding and filtering the extracted food ingredients to get juice.
8	Squeezer	It is used for grinding food ingredients by breaking in with the spiral pusher (For fruits and vegetables).
9	Juice cup	It is used to pick up juice.
10	Residue cup	It is used for loading residue.
11	Tray	It is mainly used for storing the extracted food ingredients.
12	Pushing rod	It is used for squeezing the fed food ingredients gently for their full contact with the spiral pusher and higher juice extraction efficiency.



## TECHNICAL DETAILS

<b>Rated voltage</b>	120V~
<b>Rated power</b>	150W
<b>Rated frequency</b>	60Hz
<b>Continuous operating time</b>	≤ 10 min
<b>Time interval</b>	≥ 10 min

## BEFORE USING MASTICATING JUICER

Before using the appliance for the first time, clean its parts in contact with food ingredients thoroughly.

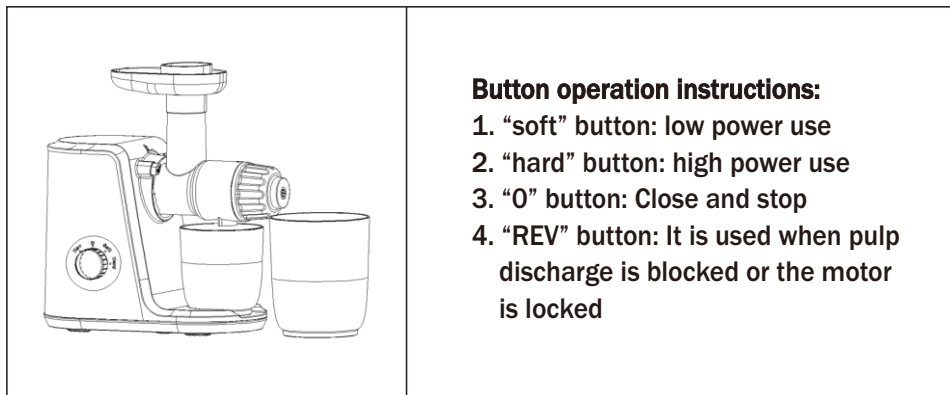

# USING YOUR MASTICATING JUICER

Please install and use the appliance following the steps below.

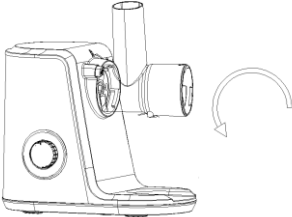
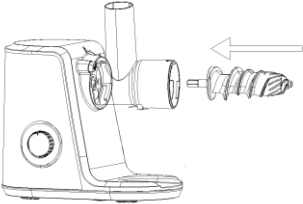
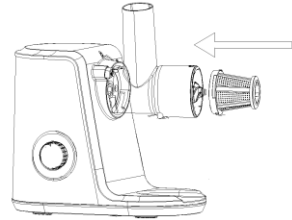
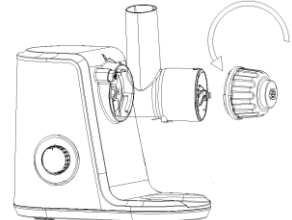
	1	<p><b>Connect the juicing body and the main body:</b></p> <p>1. Have the triangular aligning sign “▼” on the juicing body align with the aligning “unlocking triangular sign” on the main body and then put the juicing body into the main body (the three clips on the juicing body will realize alignment).</p> <p>2. Then turn the juicing body anticlockwise. When there is a click, it suggests that the connection is finished.</p>
	2	<p>Have the hexagonal shaft of the spiral pusher align with the hole on the main body and push it horizontally until it reaches the bottom (when alignment fails, just turn the spiral pusher slightly). suggests that the connection is finished.</p>
	3	<p>Fit the larger-hole end of the juicer strainer into the tail of the spiral pusher and push it while the three clips of the juicer strainer align with the three clamping slots in the juicing body. (The juice strainer is used with the juicing button in the rear only. This function is used for juicing.)</p>
	4	<p>Align the triangle alignment mark on the juice extractor with the unlock triangle mark on the juice extractor, and then put the juice into the juice extractor.</p>

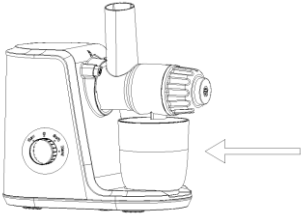
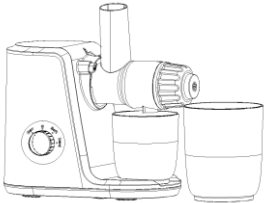
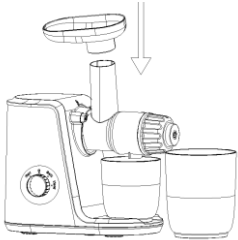
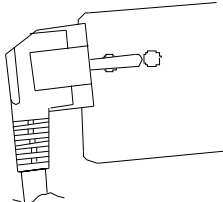
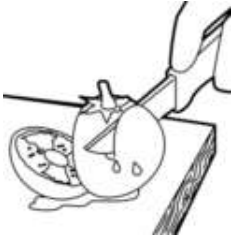
	<p>5</p>	<p>Put the juice cup in the corresponding groove on the main body and have its opening align with the bottom of the juice outlet of the juicing body.</p>
	<p>6</p>	<p>Put the pulp cup below the pulp outlet of the juicing body and have it close to the juice cup. Install the tray on the upper end of the feed port of the juicing body.</p>
	<p>7</p>	<p>The tray can make feeding of food ingredients more convenient, particularly when small-particle food ingredients like grapes and strawberries are processed.</p>
	<p>8</p>	<p>Connect the power supply for use of the appliance (make sure the switch is on the OFF position before the power supply is connected).</p>
	<p>9</p>	<p>Wash vegetables and fruits, cut them into blocks fitting the size of the feed port and put them on the tray.</p>

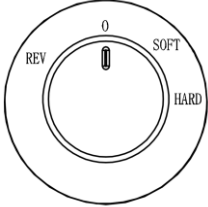
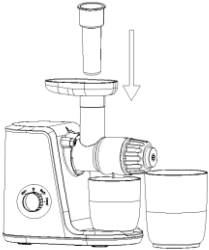
	<b>10</b>	<p>After the “SOFT or HARD” button of the switch is pressed, the appliance will begin to run for 10 minutes or a shorter time.</p>
	<b>11</b>	<p>Put food ingredients into the feed port on the juicing body cap and then push the food ingredients with help of the pushing rod.</p>

## CLEANING AND MAINTENANCE

1. Before cleaning the appliance, do switch off the switch and disconnect the power supply.
2. After use, clean the appliance promptly.
3. Do not wash the main body with water but wipe the stains on it with a piece of wrung rag or cotton cloth.
4. Before storing the appliance, make sure it is clean and dry.
5. Clean the appliance after dismantling it following the steps below.

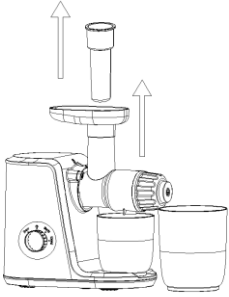
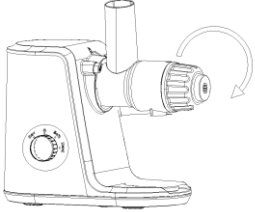
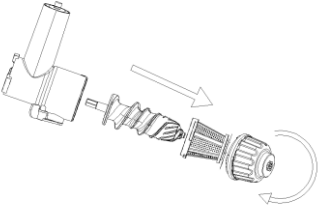
	<p><b>1</b></p>	<p>Take down the pushing rod and the tray.</p>
	<p><b>2</b></p>	<p>Press the button on the side of the juicing body and turn the juicing body clockwise at the same time to take out the juicing body. The juicing body cannot be dismantled if the button is not pressed.</p>
	<p><b>3</b></p>	<p>After taking down the juicing body, take down the juicing button (or the noodle button and so on), the juicing body cap, the juice strainer (or the squeezer) and the spiral pusher in order. The dismantlable parts may be flushed with clean water.</p>

## WARRANTY CLAIM PROCEDURE

To ensure quick processing of your case, please observe the following instructions: Please have the till receipt and the item number (S/N: 12345) available as proof of purchase.

You will find the item number as a sticker on the rear or bottom of the appliance. If malfunctions or other defects occur, please contact our customer service listed either by telephone or by email.

If you request any further assistance, please contact us:

Customer service: **1-888-965-8032**

[support@bonsenkitchen.com](mailto:support@bonsenkitchen.com)

## ENVIRONMENT FRIENDLY DISPOSAL

This product must not be disposed together with the domestic waste. This product has to be disposed at an authorized place for recycling of electrical and electronic appliances. By collecting and recycling waste, you help save natural resources, and make sure the product is disposed in an environmental friendly and health way.



Register your product at [www.bonsenkitchen.com](http://www.bonsenkitchen.com)  
to get more perks!



Follow us @bonsenkitchen

**Bonsen Electronics Inc.**

📍 : 5805C Peachtree Corners East  
Norcross, GA, 30092

☎ : 1-888-965-8032

✉ : [support@bonsenkitchen.com](mailto:support@bonsenkitchen.com)