

weltu®

weltu®

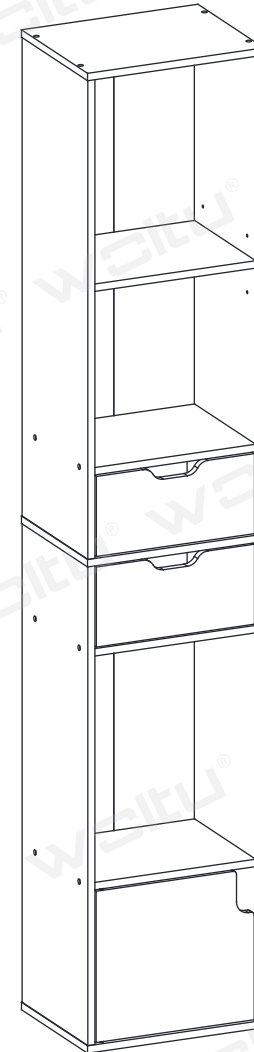

**Installation
Manual**

Aufbauanleitung / Manuel
d'installation / Manuale di istruzioni /
Instrucciones de instalación

Einleitung

- Bitte lesen Sie die folgenden Anweisungen sorgfältig durch und verwenden Sie das Produkt wie beschrieben.
- Wenn das Produkt an Dritte weitergegeben wird, geben Sie alle notwendigen Anleitungen mit.
- Alle vorliegenden Abbildungen dienen zur Veranschaulichung der Bedienungs- und Montagemethoden und können geringfügig vom tatsächlichen Aufbau des Produkts abweichen. Um Ihnen eine klare und allgemeine Zusammenfassung zu zeigen, haben wir nicht alle potenziellen Szenarien und Details beschrieben, die beim Verwenden und Aufbauen erscheinen. Wenn Sie weitere Informationen und Unterstützung bei der Anwendung benötigen, wenden Sie sich gerne an uns.

Hinweise

- Vergewissern Sie sich vor dem Aufbau des Produkts anhand der Angaben, dass alle Zubehörteile vorhanden und unbeschädigt sind. Falls nicht, setzen Sie sich rechtzeitig mit uns in Verbindung.
- Die Montage darf nur durch Erwachsene durchgeführt werden. Um ein unabsichtliches Verschlucken der mitgelieferten Kleinteile zu vermeiden, halten Sie Ihre Kinder bei der Montage von dem Produkt fern.
- Vergewissern Sie sich, die mitgelieferte Kippsicherung an der Wand zu befestigen.
- Vergewissern Sie sich, dass zur Montage und Verwendung des Produkts ein fester und ebener Untergrund zur Verfügung steht. Dadurch wird das Risiko umzukippen oder umzufallen wesentlich verringert.
- Achten Sie darauf, dass die Schrauben beim Festziehen nicht überdreht werden. Sonst werden die entsprechenden Zubehörteile beschädigt und nicht richtig befestigt.
- Führen Sie nach der Montage eine Sicherheitskontrolle an dem Produkt durch. Überprüfen Sie, ob alle Anschlüsse fest und dicht angezogen sind.
- Lassen Sie Kinder nicht unbeaufsichtigt an dem Produkt rumklettern oder baumeln, da es zu einem lebensbedrohlichen Umkippen kommen kann.
- Lehnen, setzen oder stellen Sie sich nicht auf das Produkt.
- Überprüfen Sie alle vorhandenen beweglichen Teile regelmäßig auf Lockerheit oder Verschleiß und ziehen Sie sie rechtzeitig nach oder verriegeln Sie sie.

- Überlasten Sie das Produkt nicht, da es beim Umkippen schwere Verletzungen oder Schäden an Ihrem Eigentum verursachen könnte.
- Nutzen oder bewegen Sie das Produkt erst, wenn es entladen ist.
- Reinigen Sie das Produkt mit einem weichen feuchten Tuch und milden Reinigungsmitteln.
- Setzen Sie das Produkt keinem direkten Sonnenlicht aus. Lassen Sie das Produkt nicht mit scharfen Gegenständen in Kontakt kommen, um Schäden zu vermeiden.

Warnung

- Verwenden Sie das Produkt erst, wenn es ordnungsgemäß und vollständig zusammengebaut ist.
- Nehmen Sie keine Veränderung an dem Produkt vor und verwenden Sie keine Ersatzteile.
- Das Produkt ist nur für die vorgegebene Funktion bestimmt und darf nicht zweckentfremdet werden.

Kundendienst

- Bitte wenden Sie sich bei Problemen an unser Kundenservice-Team. Sie können uns über das Verkaufsportal, bei dem Sie bestellt haben, kontaktieren.

General Guidelines

- Please read the following tips carefully and use the product correctly.
- If you buy the product for others, please keep these tips and send them to the receiver.
- In order for you to have a clear and summary preview, we have not described all possible scenarios and installation details that may be involved. If you need more information and help, please contact us.

Notes

- Please check if all the parts are complete and in good condition according to the instructions before installation. If not, please do not set it up, but contact us as soon as possible.
- Please keep children away during installation to avoid accidental swallowing of tiny accessories.

- Please fix the safety device to the wall to prevent overturning.
- Please install and use the product on a solid and flat floor to avoid the risk of safety accidents caused by tipping over.
- Please do not fix the screws extra tight, or the parts might be damaged.
- Please check and make sure all the parts are installed well after installation finished.
- Kids are not allowed to climb on or hang on the product, in case of a life-threatening toppling.
- Please do not lean or stay on the product.
- Please check regularly if the screws get loose, if yes, please fix them well again to make sure the stability of the product.
- Please do not put items overweight, or there might be a risk of serious personal injury or damage to personal belongings due to rollover.
- Be sure to unload the items on the shelf before moving.
- Wipe with a dry cloth or a damp cloth.
- Please do not expose the product to strong sunlight, and keep away from sharp objects to avoid damage.

Warnings

- Please do not use the product before finishing the installation.
- Do not modify this product or use alternative accessories.
- This product shall not be used for any purpose other than function of the product.

Customer Service

- If any questions, please contact our customer service team through the corresponding purchase platform.

FR

Introduction

- Veuillez lire attentivement les manuels suivants et utiliser correctement le produit, s'il vous plaît!
- Si vous livrez le produit à un tiers, veuillez conserver ces manuels et transmettez-les-leur, s'il vous plaît!
- Afin que vous ayez un aperçu clair et général, nous n'avons pas décrit tous les scénarios possibles et les détails d'installation qui peuvent être impliqués. Si vous avez besoin de plus d'informations et d'aide, n'hésitez pas à nous

contacter, s'il vous plaît!

Notes

- Il est nécessaire de vérifier la quantité de toutes les pièces installées sur la liste des accessoires avant l'installation, s'il en manque, veuillez nous contacter.
- Étant donné qu'il y a de petits accessoires, veuillez garder les enfants éloignés pendant l'installation pour éviter tout danger.
- Veuillez fixer le dispositif de sécurité sur le mur pour éviter tout renversement.
- Veuillez utiliser ce produit sur un sol plat afin d'éviter les accidents dus au renversement.
- Veuillez ne pas trop serrer les vis, sinon les pièces pourraient être endommagées.
- Après l'installation, veuillez vérifier si tous les accessoires sont bien serrés.
- Veuillez ne pas laisser les enfants grimper sur ou s'accrocher à ce produit pour éviter des accidents mettant la vie en danger.
- Veuillez ne pas vous appuyer, vous asseoir ou monter sur ce produit.
- Veuillez vérifier régulièrement le serrage des vis de ce produit pour assurer sa stabilité.
- Veuillez ne pas surcharger le produit pour éviter le renversement en causant des dommages aux personnes ou aux biens.
- Assurez-vous d'enlever tous les objets sur le produit avant de le transporter ou de le déplacer.
- Pour nettoyer ce produit, veuillez l'essuyer avec un chiffon souple humide et un détergent neutre.
- Veuillez ne pas exposer ce produit sous le soleil et évitez toutes les égratignures venant des objets pointus.

Avertissements

- N'utilisez pas ce produit avant de réussir l'assemblage.
- Ne modifiez pas ce produit et n'utilisez pas d'accessoires de remplacement.
- Ce produit ne doit pas être utilisé à des usages autres que la fonction du produit.

Service après-vente

- Si vous avez des questions, veuillez contacter notre équipe du service de

client sur la plateforme d'achat correspondant à votre commande, s'il vous plaît.

IT

Linee guida generali

- Si prega di leggere attentamente le istruzioni riportate di seguito e di utilizzare correttamente il prodotto.
- Se il prodotto deve essere consegnato a terzi, si prega di conservare e includere queste istruzioni.
- Al fine di fornire un'anteprima di riepilogo chiara e generale, non abbiamo descritto tutti i possibili scenari e dettagli di montaggio che possono essere coinvolti. Se hai bisogno di aiuto e maggiori informazioni, non esitare a contattarci.

Note

- Prima del montaggio, controllare che tutte le componenti elencate nelle istruzioni siano presenti e in buone condizioni, in caso di parti mancanti o danneggiate, non procedere al montaggio e contattarci immediatamente.
- Questo prodotto deve essere montato da un adulto. Non lasciare che i bambini partecipino al montaggio, in quanto sono presenti piccole parti che potrebbero essere accidentalmente ingerite.
- Questo prodotto è dotato di sistema antiribaltamento, fissalo al muro per maggiore sicurezza.
- Questo prodotto deve essere montato e posizionato su un suolo piano e compatto, in modo da evitare incidenti di sicurezza causati dal ribaltamento.
- Non stringere eccessivamente le viti, in quanto certe parti potrebbero danneggiarsi e non fissarsi in modo corretto.
- Una volta terminato il montaggio, controllare che tutte le parti siano fissate correttamente e in modo compatto.
- Non consentire ai bambini di arrampicarsi o appendersi al prodotto, per evitare incidenti che potrebbero mettere a rischio la vita.
- Non appoggiarsi, sedersi o salire su questo prodotto.
- Controllare regolarmente che le viti e le componenti del prodotto siano ben fissate, in caso di allentamento, serrarle a dovere.
- Non sovraccaricare il prodotto, per evitare il rischio di ribaltamento che potrebbe causare gravi lesioni personali o danni agli effetti personali.

- Assicurarsi di rimuovere gli oggetti posizionati sul prodotto prima di spostarlo.
- Per pulire questo prodotto, utilizzare un panno morbido umido e un detergente neutro.
- Tenere il prodotto lontano dalla luce diretta del sole e da oggetti appuntiti.

Avvertenze

- Accertarsi che il prodotto sia stato montato correttamente prima di utilizzarlo.
- Non modificare questo prodotto o utilizzare accessori sostitutivi.
- È vietato utilizzare questo prodotto per scopi diversi dalla funzione del prodotto.

Assistenza post-vendita

- Se avete qualsiasi problema, si prega di contattare il nostro servizio clienti attraverso il canale d'acquisto in cui è stato effettuato l'ordine.

ES

Acerca del manual

- Lea las siguientes instrucciones detenidamente y utilice el producto correctamente.
- Si entrega el producto a un tercero, conserve estas instrucciones y entrégueselas.
- Para que tenga una vista previa clara y resumida, no hemos descrito todos los escenarios posibles y los detalles de instalación relativos. Si necesita más información y ayuda, comuníquese con nosotros.

Notas

- Antes del montaje, consulte bien el manual de instalación y asegure que todos los componentes estén presentes. Si falta alguna pieza, póngase en contacto con nosotros.
- El producto debe ser instalado por un adulto. Por favor no deje al niño participar en el proceso de montaje para evitar que tragan accidentalmente los accesorios pequeños.
- Este producto equipa con un dispositivo antivuelco, fíjelo a la pared para garantizar la seguridad.
- Coloque el producto sobre una superficie sólida y plana para evitar incidentes causados por vuelcos.









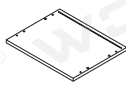
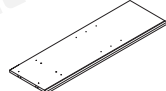
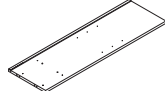
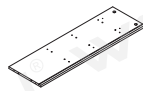

- No apriete demasiado los tornillos. De lo contrario, algunos componentes se dañarán y no se podrán fijar correctamente.
- Una vez terminado el montaje, compruebe que todas las piezas estén fijadas de forma adecuada y compacta.
- No deja a los niños subir al producto para evitar accidentes potencialmente mortales.
- No se siente, se apoye ni se pare sobre el producto.
- Compruebe con regularidad que los tornillos y las partes del producto estén bien fijadas; si se aflojan, apriételes correctamente.
- No sobrecargue el producto para evitar el riesgo de vuelco, que podría causar lesiones o daños personales graves.
- Antes de moverlo, asegúrese de haber quitado todos los objetos colocados sobre el producto.
- Para limpiarlo, use un paño suave y mojado con la loción detergente neutra.
- No exponga este producto al sol durante mucho tiempo y para evitar daños, no lo toque con objetos agudos.

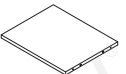
Advertencias

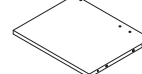

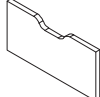

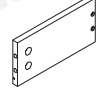
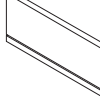
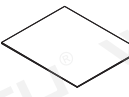
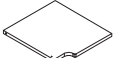













- No use este producto hasta que se haya terminado la instalación correctamente.
- No modifique este producto ni utilice accesorios suplentes.
- Está prohibido usar este producto para cualquier propósito que no sea su función.

Servicio postventa

- Si tiene alguna pregunta, por favor comuníquese con nuestro equipo de servicio al cliente a través de la plataforma de compra de pedidos correspondientes.

UNIT:MM				
①×1pc 	②×1pc 	③×1pc 	④×1pc 	⑤×1pc 
⑥×2pcs 	⑦×1pc 	⑧×1pc 	⑨×1pc 	⑩×4pcs 
⑪×2pcs 	⑫×2pcs 	⑬×2pcs 	⑭×2pcs 	⑮×2pcs 
⑯×1pc 	⑰×2pcs 	⑱×1pc 		

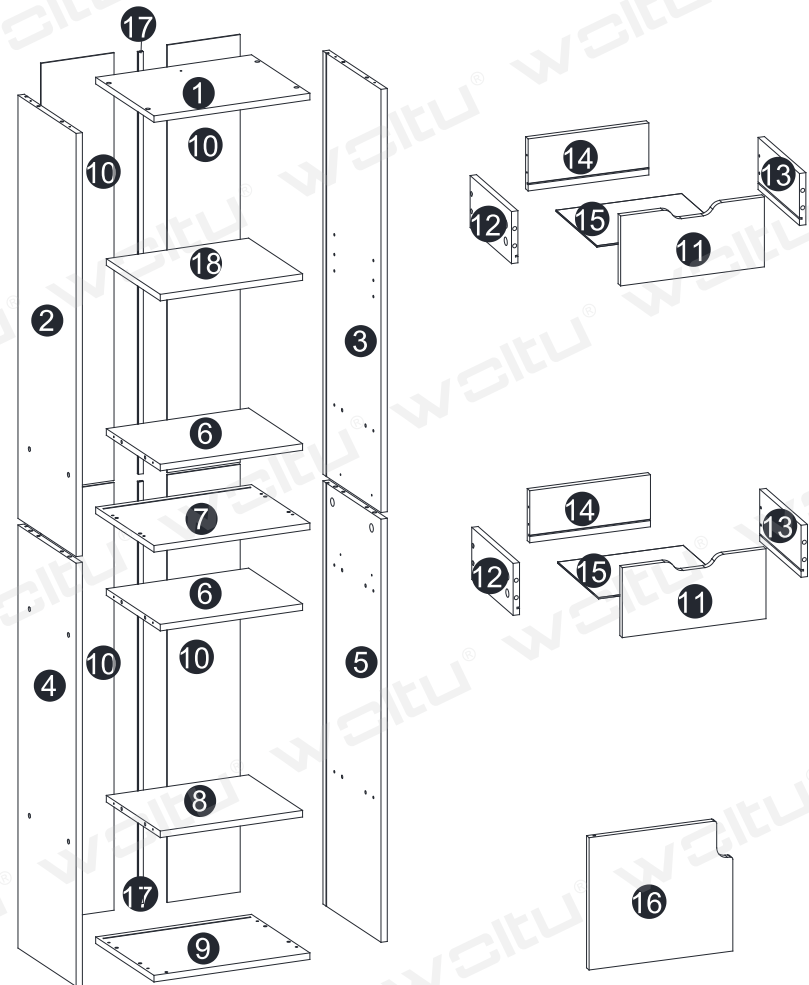

UNIT:MM

A×12pcs	B×12pcs	C×20pcs	D×33pcs	E×17pcs	F×10pcs	G×10pcs	H×6pcs
							
I×1pc	J×1pc	K×1pc	L×1pc	M×1pc	N×4pcs	O×12pcs	CL×2pcs
							
CR×2pcs	DL×2pcs	DR×2pcs					
							

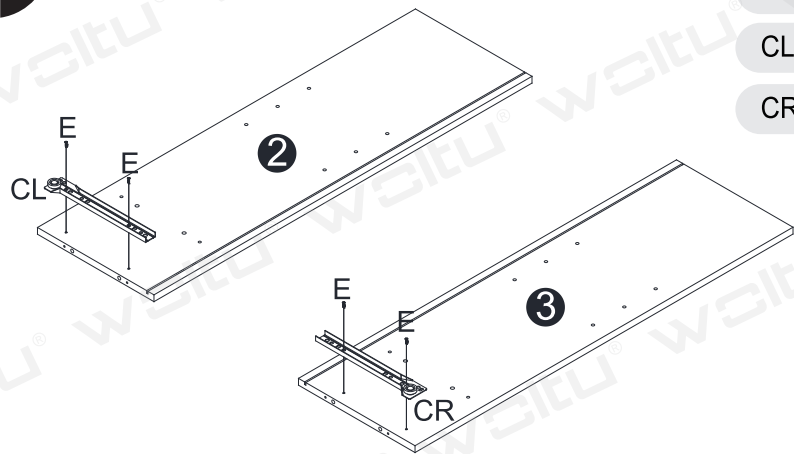

1



- E  x4
- CL  x1
- CR  x1

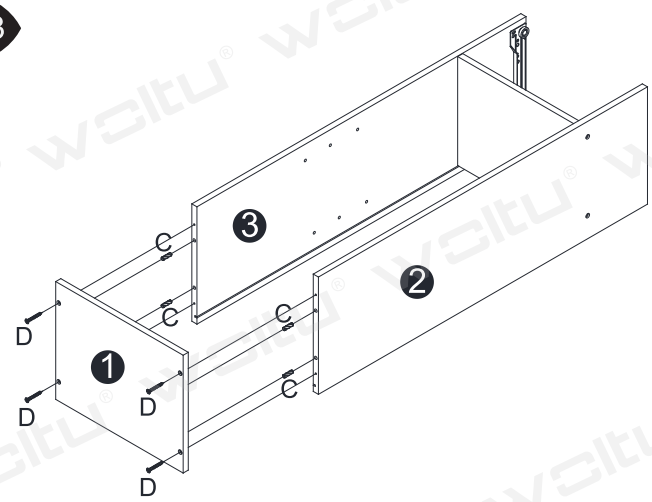

3

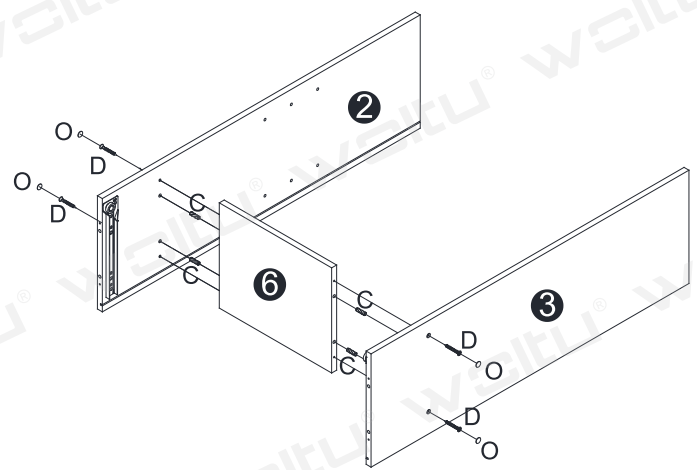

- C  x4
- D  x4

2





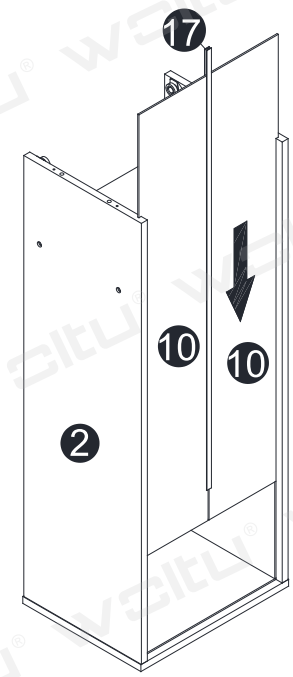

- C  x4
- D  x4
- O  x4

4

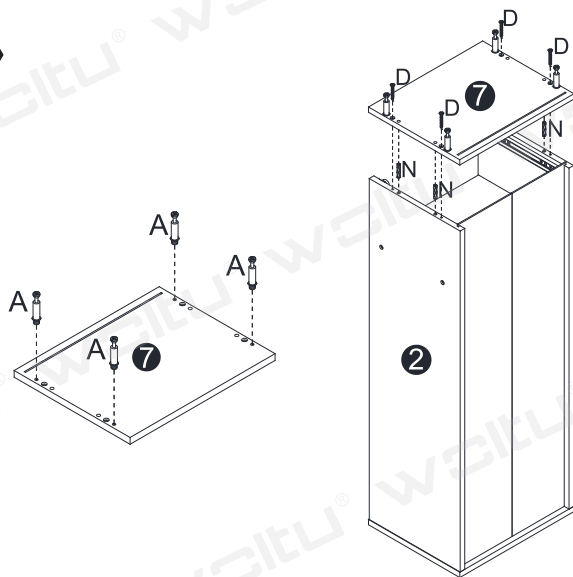







5

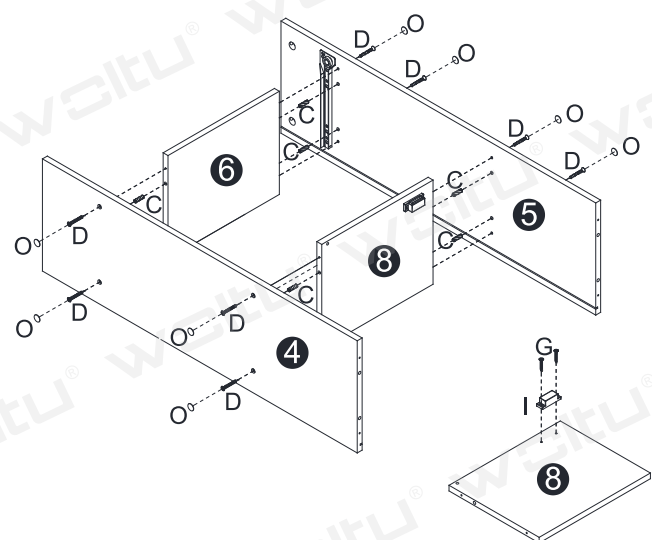

- A  x4
- D  x4
- N  x4



7



- C  x8
- D  x8
- G  x2
- I  x1
- O  x8

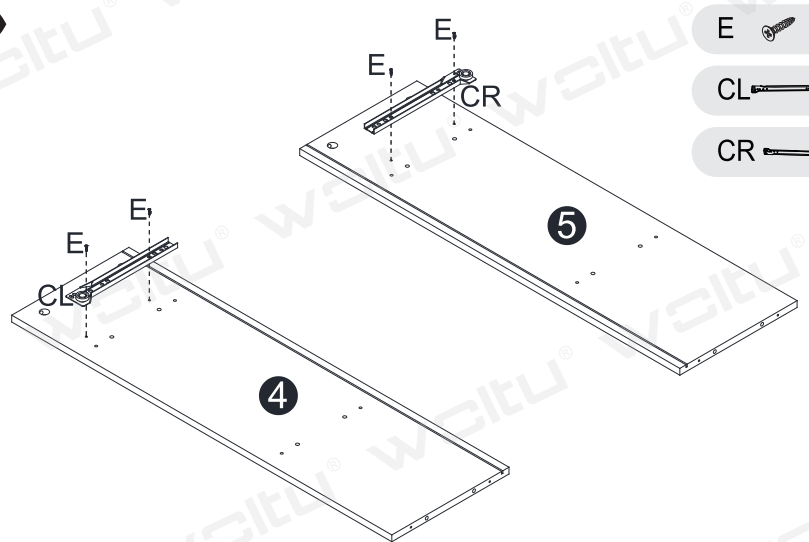



6

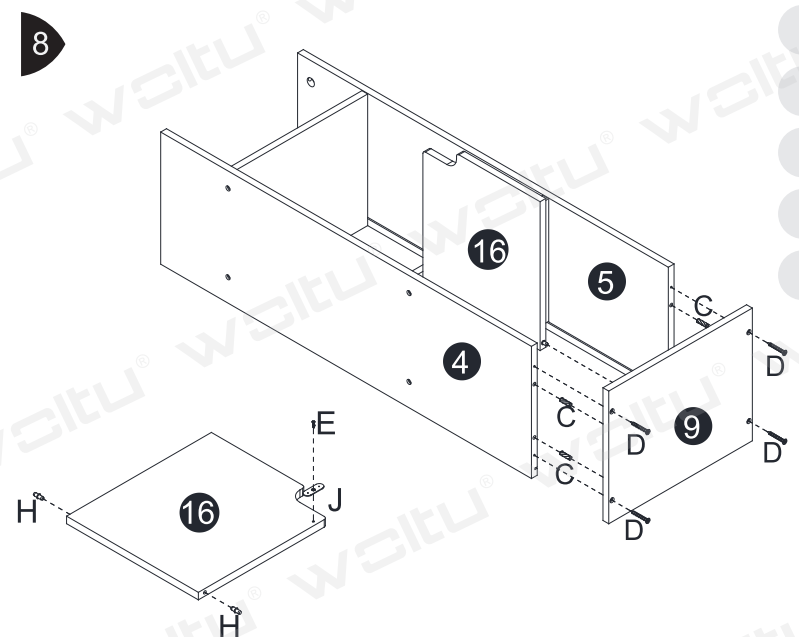

- E  x4
- CL  x1
- CR  x1

8



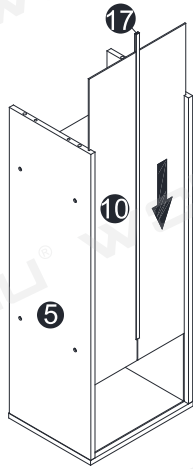

- C  x4
- D  x4
- E  x1
- H  x2
- J  x1

9



11

- F  x10
- G  x10



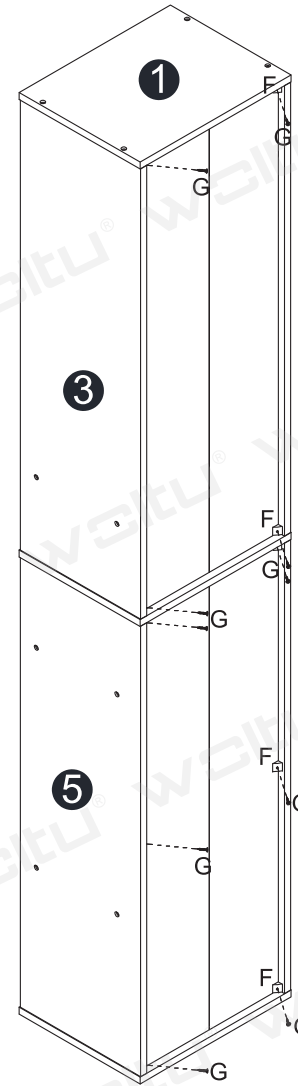
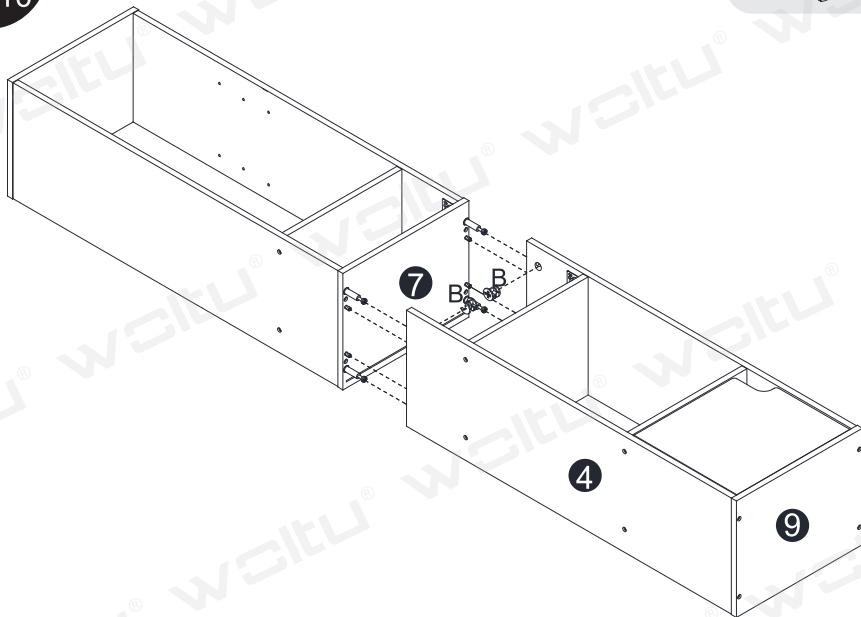

10

- B  x4

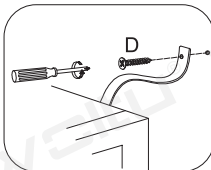
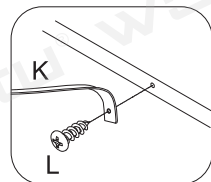
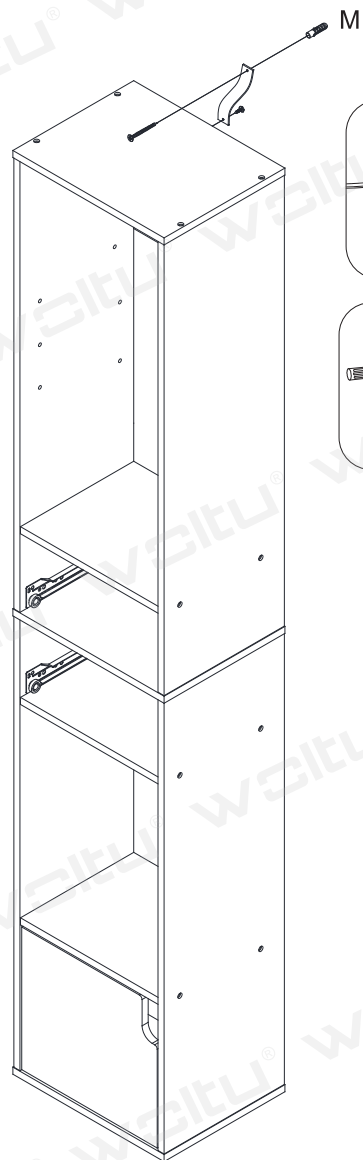







12

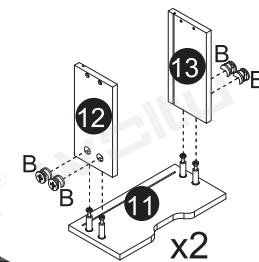
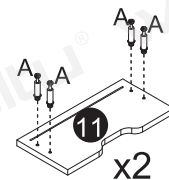

- D  x1
- L  x1
- K  x1
- M  x1

13



- A  x8
- B  x8
- D  x8
- E  x8
- DL  x2
- DR  x2

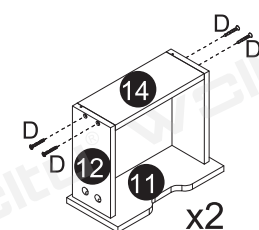
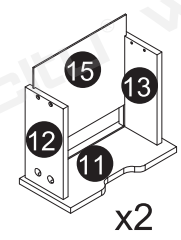
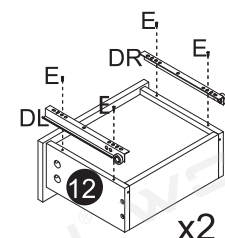

14

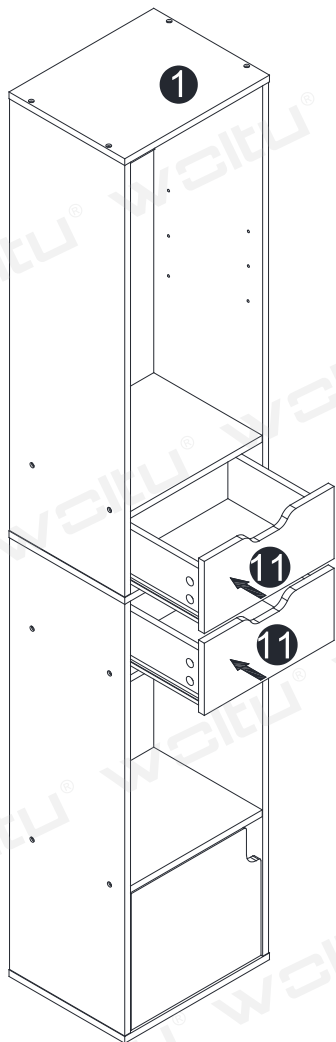

15

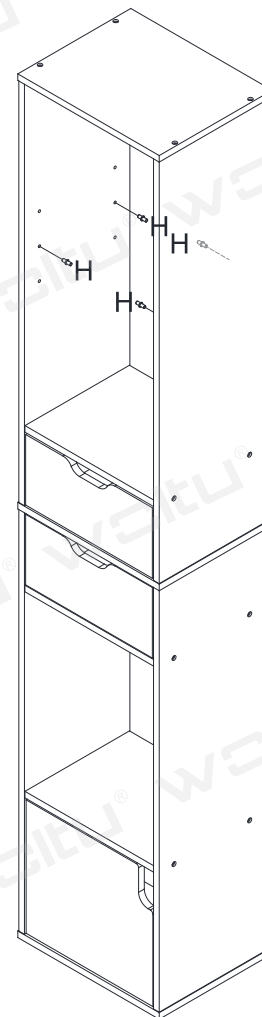

H  x4

16

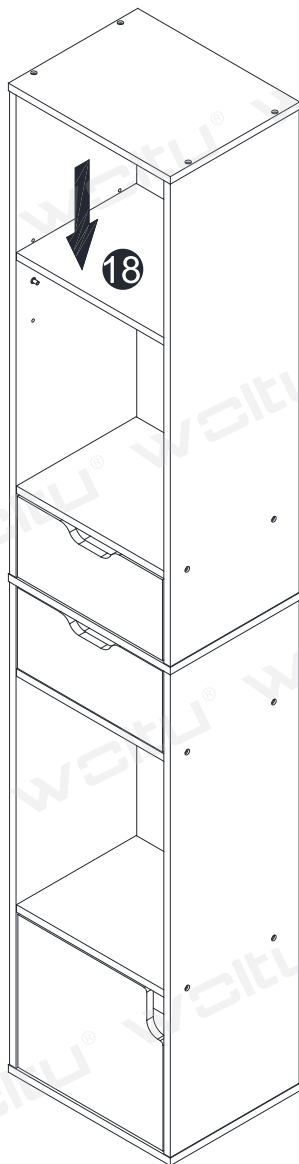

17

