

# VCK

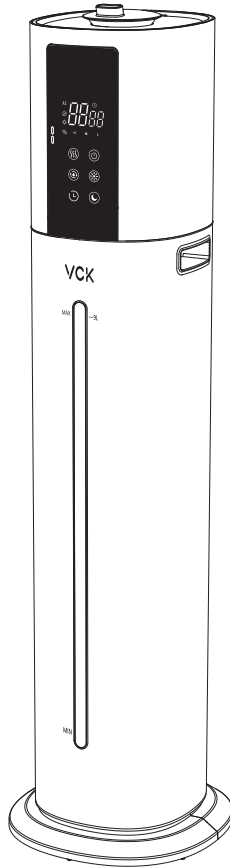

## User Manual HUMIDIFIER

Read And Save These Instructions

# CONTENTS

STATEMENT	01
PRODUCT DIAGRAM	01
FEATURES/LED DISPLAY	02
OPERATIONS AND FUNCTIONS	03/04
DETAIL OPERATION	05
Remote Control	06
CLEANING AND MAINTEN ANCE	06
Scale Removal Instructions	07/08
Disinfecting Instructions	09
SAFETY INSTRUCTIONS	10/14
PACKAGE CONTENTS/SPECIFIC ATIONS	15
TROUBLESHOOTING GUIDE	16
WARRANTY & CUSTOMER SUPPORT	17

# STATEMENT

Thank you for purchasing the VCK LE-H007A Ultrasonic Cool Mist Humidifier, Please read this user manual carefully and keep it for future reference. If you need any assistance, please contact our support team with your product model number and the order number.

Support and after-sale service: [support@vckhome.com](mailto:support@vckhome.com)

# PRODUCT DIAGRAM

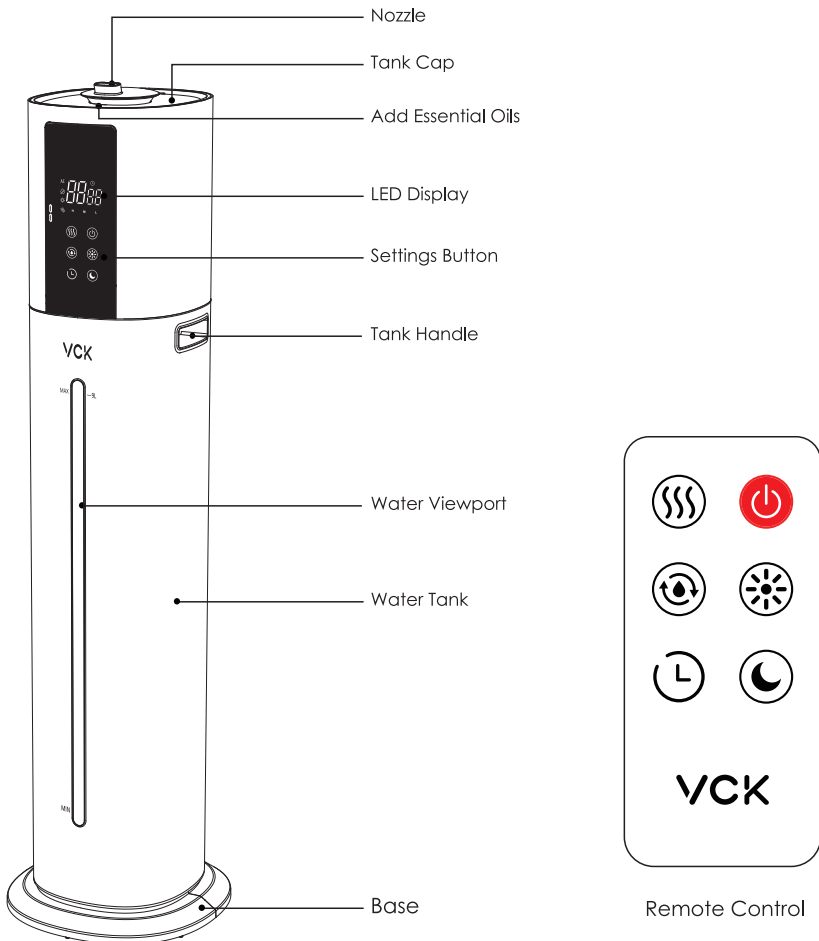

## FEATURES

### 1. 360°Rotary Nozzle

Turn the mist output in any direction

### 2. Auto Shut-Off Protection

Stop working automatically when it runs out of water

### 3. 9L Large Capacity

9L/2.38Gal water tank can meet your daily needs

### 4. 24H Timer Function

Set the working hours you want

### 5. 3 Mist Level & Custom Humidity

There are 3 mist levels for this humidifier, set a constant humidity and the humidity value from 40%-90%.

### 6. Touch & Remote Control

It has sensitive touch operation, and can also be controlled with remote control.

### 7. Top Fill Design

Easily open the lid to add water from the top.

### 8. Ultra-Quiet Operation

## LED DISPLAY

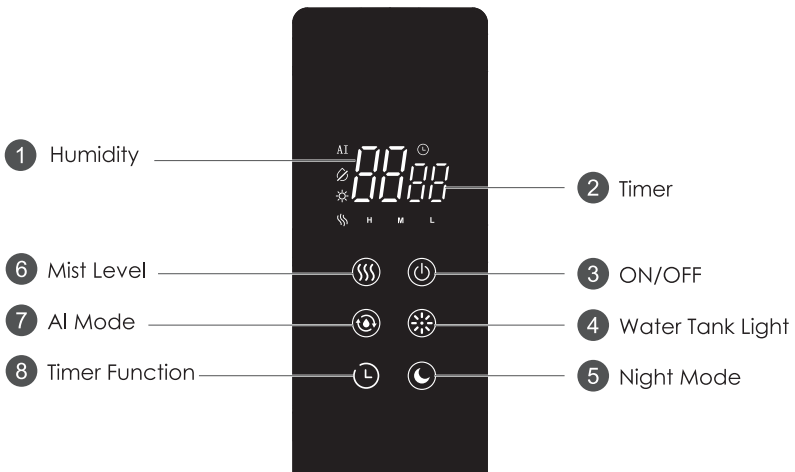

The most comfortable environmental humidity is between 40%-60%. Please adjust the mist as needed.

# OPERATIONS AND FUNCTIONS

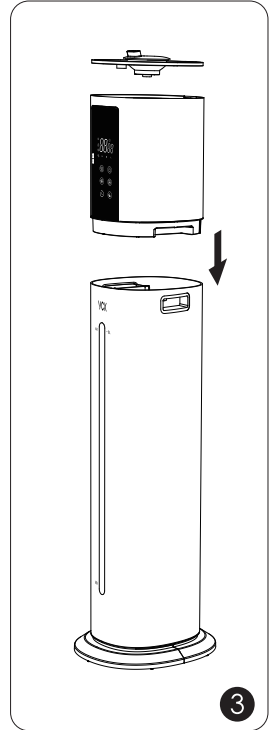
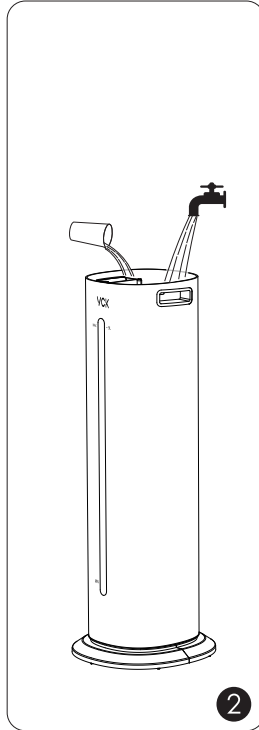
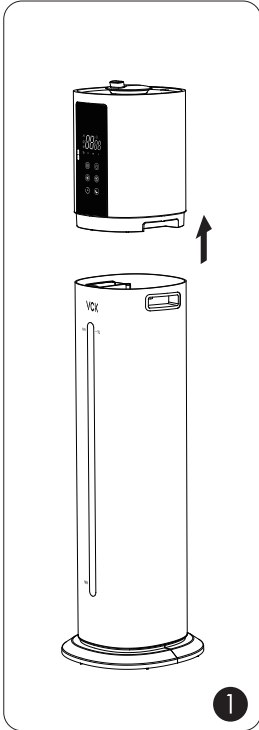

## Add water

1. Remove the tank cap.
2. Fill the tank with clean water only.
3. Attach the tank cap and place the tank back onto the base.



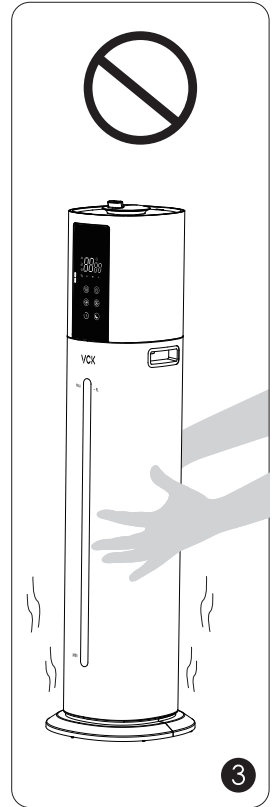
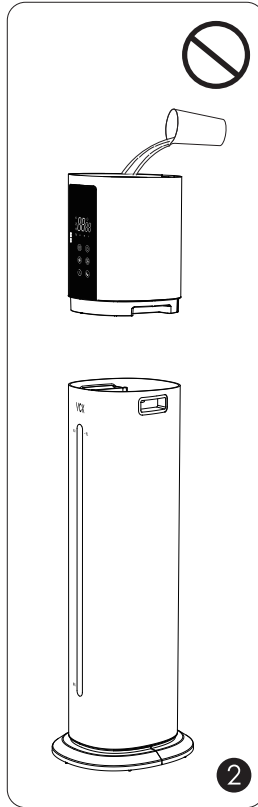
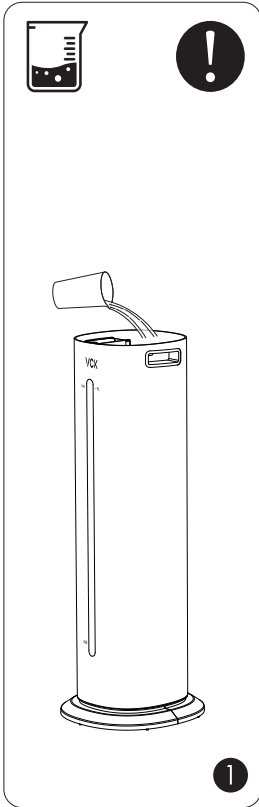



Please make sure it fits together securely so that water can go from the tank to the reservoir.

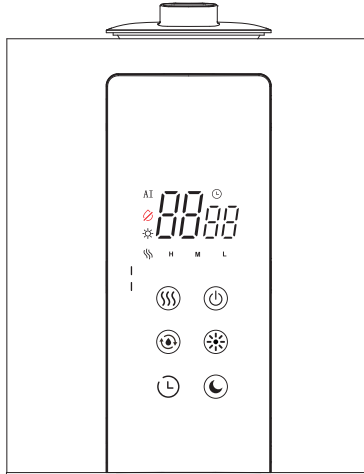

1. If tap water is too hard, it is recommended to use filtered or distilled water to avoid white dust. DO NOT use hot water.
2. DO NOT add water into the nozzle.
3. DO NOT move the humidifier while the water tank is full of water to avoid leakage or base overfilling.

## DETAIL OPERATION



- 1.  ON/OFF**  
Humidifier ON/OFF button, control LED screen display/off.
- 2.  Mist Level**  
Press the button to adjust the mist output of the humidifier, which is divided into three levels: "High", "Medium" and "Low".
- 3.  AI Mode**  
In AI mode, Press the key to set a constant humidity. The adjustable humidity value ranges from 40% RH~90% RH. When the humidity reaches, it will automatically stop humidity, lower than the setting will automatically re-start humidity.
- 4.  Water Tank Light**  
Click the button to increase the light of the humidifier water tank and observe the water level at night.
- 5.  Timer Function**  
Touch the timer key to adjust the timer function. You can choose between 1-24 hours.  
Cancellation function: When you want to cancel the timing function, you can long press the timing button, or re-adjust the timing time to "00" state, when the system prompt sounds, the timing function is off.
- 6.  Night Mode**  
Click the screen off button, the LED screen goes out, which is convenient for sleeping at night and saving energy.

## 7. Water Shortage Indicator

When the water level of the humidifier water tank is lower than the minimum water level standard, the product's red water shortage indicator lights up, and a system prompt sounds, and tap water/distilled water needs to be replenished in time. After the water level returns to normal, the product works normally and the indicator light disappears.

## Remote Control

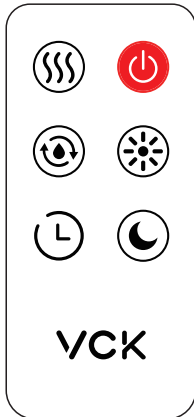

The buttons on the remote control such as ON/OFF, Timing, Mist Level, Humidity, "+" and "-" have the same functions as those of the corresponding keys on the touch panel.

## CLEANING AND MAINTENANCE

### Daily Maintenance

Turn off the humidifier, and unplug it from the power source. Drain water from the tank, reservoir and base.

### Weekly Maintenance

#### Click to turn on/off the humidifier

1. To properly clean your humidifier, we recommend you remove the scale and disinfect the humidifier separately.
2. DO NOT mix vinegar and bleach solutions together. Do not use more than 1 tsp. Of bleach per gallon of water to avoid damaging your humidifier.
3. Please make sure the sealing ring on the tank cap is installed properly after cleaning to avoid water leakage.

## Scale Removal Instructions

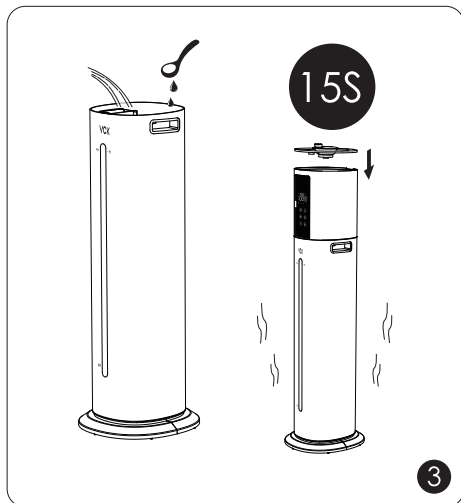
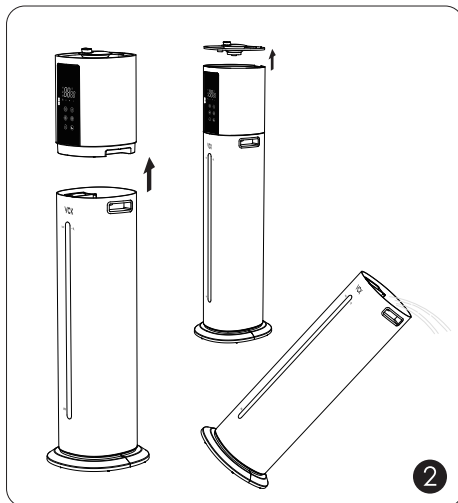
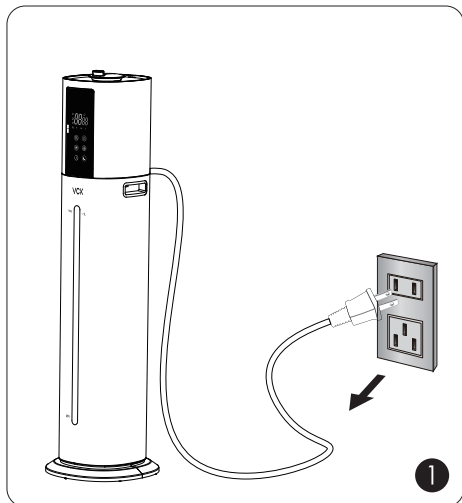

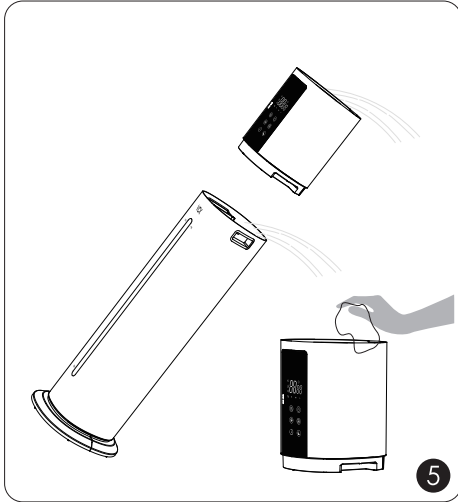

## Exclude Solution

1. Turn off and unplug the humidifier.
2. Remove the water tank from the base. Remove the tank cap. Drain water from the water tank and base. Remove any accessories and set aside.
3. Fill the water tank half full. Add in 1 teaspoon of undiluted distilled white vinegar. Attach the tank cap and shake for 15 seconds.
4. Place the tank onto the base. The vinegar solution will enter the water reservoir to loosen mineral buildup (scale) on the atomizer, water floater and the bottom of the water tank. Set still for 15-20 minutes.
5. Uncap the tank cap and drain the solution. Wipe the atomizer and floater with a soft cloth to remove loosened mineral deposits.  
  
Rinse both the water reservoir and water tank until the smell of vinegar (for scale removal) or bleach solution (for disinfecting, see below) is gone.

## **Disinfecting Instructions**

1. Follow steps 1-2 of the previous section on scale removal.
2. Fill the water tank half full. Add in ½ tsp of bleach. Place the tank cap back on. Swish the solution around in tank. Place the tank on the base. The bleach solution will enter and disinfect the water reservoir as well as the other components. Set still for 15-20 minutes.
3. Follow steps 4-5 of the previous section on scale removal to complete disinfecting the humidifier.

## **Notice**

It is not recommended to flush the sink with water directly to avoid water splashing into the control panel from the air outlet. If water drips into the control panel, it will directly affect the normal operation of the product. When cleaning the sink, do not plug in the device if water drips into the air vent accidentally. and place the device in front. Then let the water drain through the drainage holes of the base, and drain it in a ventilated place for 3 days, until the water is completely evaporated before use.

## **End-Of-Season Care and Storage**

1. Follow the cleaning instructions when the humidifier will not be used for at least one week, or at the end of the season. Remove any accessories used with the humidifier and allow the humidifier and accessories to dry completely before storing.
2. DO NOT store water inside the base, water reservoir, or tank.
3. Pack the unit safely and store it in a cool, dry location.

## SAFETY INSTRUCTIONS

The humidifier was made with safe and environmental protection materials and it has been certified and complied with the requirement of sale regions' related regulations or laws.

**IMPORTANT:** Please read and save this SAFETY INSTRUCTIONS before using the device. Basic precautions should always be followed to reduce the risk of fire, electrical shock, and injury to persons or damage to the product.

### BEFORE USING THE HUMIDIFIER



1. A collision with a hard object may cause the product to rupture, please handle it with care and do not hit the hard object.
2. DO NOT place this humidifier in wet environments.



Please always keep the humidifier out of reach of patients & children & pets.

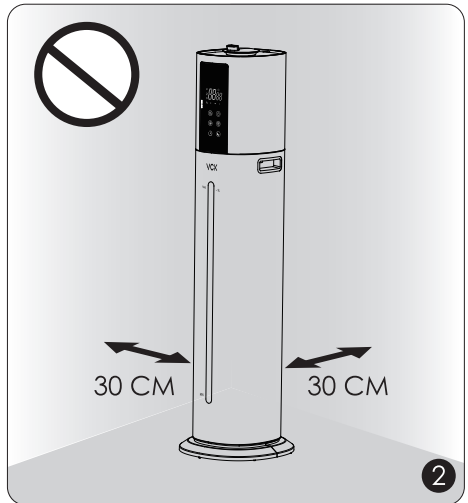
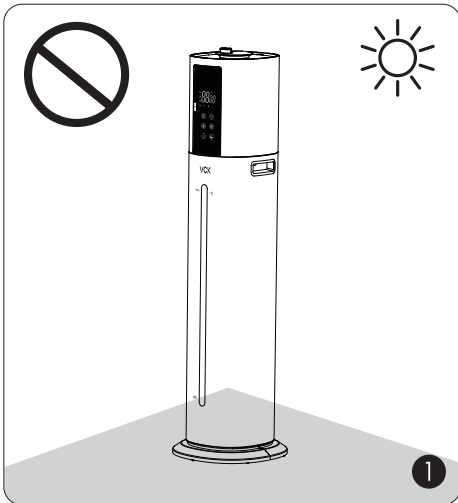

1. Please always place the unit on a smooth, flat, lint-free, non-metallic, waterproof and level surface and keep it away from direct sunlight.
2. Always place the unit, 12 inches (30 cm) away from the wall, other appliances or wooden furniture.



1. DO NOT place the unit on carpet, towel or wood surface, which will block the vent and may damage the unit.
2. DO NOT place the humidifier near naked flames and heat sources, such as stove tops, ovens, radiators or computers.



1. Please extend the cord and check for any signs of damage. Do not use the humidifier if the cord has been damaged.

## WHEN USING THE HUMIDIFIER



1. DO NOT plug the unit with wet hands.
2. DO NOT direct the mist nozzle against the wall.



1. DO NOT use your hand or any other object to cover the nozzle while the unit is on to avoid damaging the product or causing injury.
2. DO NOT clean the unit while it is connected to a power source or while it is on.

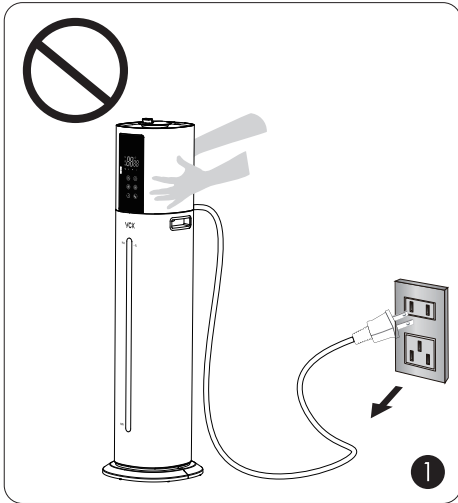

1. DO NOT move or tilt the humidifier while it is in operation.
2. The most comfortable environmental humidity is between 40%-60%. Please adjust the mist as needed.

## AFTER USING THE HUMIDIFIER

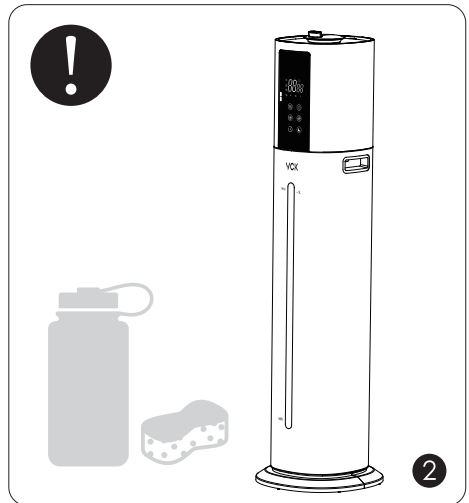
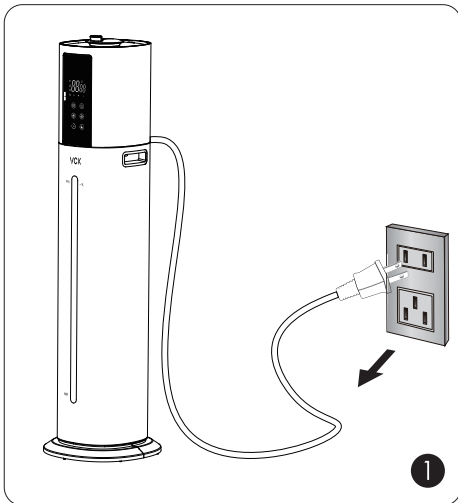

1. Always disconnect from a power source by pulling the plug when not in use.
2. Humidifier requires regular cleaning. Please refer to, and follow the Cleaning and Maintenance instructions.



DO NOT attempt to repair or adjust any electrical or mechanical functions on this humidifier.

## PACKAGE CONTENTS

- 1 X Humidifier (Model: LE-H007A)
- 1 X User Manual
- 1 X Remote Control
- 1 X Power Cable

## SPECIFICATIONS

Model	LE-H007A
Operating Voltage	AC 120V/60Hz
Rated Power	23W
Water Tank Capacity	9L/2.38Gal

## TROUBLESHOOTING GUIDE

1. If the information listed in the troubleshooting guide can't solve your problem, please email us for help.
2. Please keep it clean. If there are mineral deposits, it may affect the operation of the machine.
3. Customer failure to follow these instructions may void the warranty.

Problem	Possible Cause	Solution
No mist or little mist is produced	Not enough water inside the tank	Refill and reinst all the water tank
	Mist level is set too low	Adjust to maximum mist
	Mineral buildup on the atomizer	Feel if any air comes out from the nozzle. If yes, then clean water scale on the atomizer as instructed
	The base might be over filled	Remove the tank, empty the base and place the filled tank on the empty base
Tank leakage	Tank may be damaged	Check for possible cracks in the tank. If there is a crack, please contact our customer service to solve it.
Mist height is low, damping surrounding desk or floor.  Condensation forms around humidifier or on windows and walls Poor humidification	Mist level is set too high for the room size	<ol style="list-style-type: none"> <li>1. Check if the room is too humid and adjust to lower mist. 40%-60% works best</li> <li>2. Open door and windows, or change to a larger room</li> </ol>
	Air inlet is blocked	Humidifier should be placed on a hard flat surface, make sure no objects around the air inlet.
	Low indoor temperature leads to liquefaction	Raise the room temperature to 25°C / 77°F

Poor humidification	Mist level is set too low for the room size	1. Adjust to maximum mist 2. Close door or windows to reduce air ventilation, or change to a smaller room
	Air inlet is blocked	Humidifier should be placed on a hard flat surface, 2 feet above the floor, 12 inches away from the wall
	Low indoor temperature leads to liquefaction	Raise the room temperature to 25°C / 77°F
White dust appears or the black coating on the base flakes off	Tap water may contain too much minerals	Replace with filtered or distilled water
Strange Odor	Clean the unit	1. Clean the humidifier as instructed 2. Leave the empty and opened water tank in a cool place for 12 hours without the tank cap attached
Strange water noise	Water is going down to the water reservoir	This is normal while it is working
Humidifier is getting too hot	Unit works for too long	Power off and place in a well-ventilated place for 10 minutes

## WARRANTY & CUSTOMER SUPPORT

For questions, support, or warranty claims, contact us at the address below that corresponds with your region. Please include your order number and product model number.

**E-mail: [support@vckhome.com](mailto:support@vckhome.com)**

\* Please note, VCK can only provide after-sales service for products purchased directly from VCK. If you have purchased from a different seller, please contact them directly for service or warranty issues.

Model: LE-H007A

**VCK**

**ULTRASONIC COOL MIST HUMIDIFIER**

E-mail: [support@vckhome.com](mailto:support@vckhome.com)

MADE IN CHINA