



DEERC

14+
age

Instructions For Use Gebrauchsanweisung

V6.0

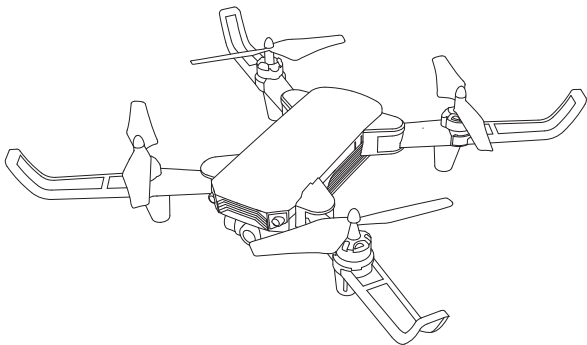

D20



usa@deerc.com (USA) eu@deerc.com (EU)



+1(855)777-8866

• English 01-29 •

• Deutsch 30-56 •

Contents

1.0 Disclaimer & Warning	01
2.0 Safety Guidelines	01
3.0 Maintenance	05
4.0 Package Contents	06
5.0 Drone Details	07
6.0 Transmitter Details	08
7.0 Joystick Mode	09
8.0 Charging	10
9.0 Installation	
Propeller	11
Propeller Guard	11
Drone Battery	12
Camera Angle Adjustment	12
Transmitter Battery	13
Phone Holder	13
10.0 Operation Guide	
Download APP	14
Connect to Wi-Fi	14
Pairing	15
Calibrating the Gyro	16
Takeoff	16
Landing	17
11.0 Functions Details	
Emergency Stop	17
Trimmer Function.....	18
Take Photo/Video	19
Speed Switch.....	19
360° Flip	20
Headless Mode	21
12.0 Specifications	22
13.0 Trouble Shooting.....	24
14.0 Contact Us.....	24
15.0 General Information	25

1.0 DISCLAIMER & WARNING

1. Please read this Disclaimer & Warning and Safety Guidelines carefully before using our product. This product is not recommended for people under the age of 14. By using this product, you hereby agree to this disclaimer and signify that you have read it fully. You agree that you are responsible for your own conduct and any damage caused while using this product, and any consequence. You agree to only use this product for its designed purposes and in accordance with the local laws, regulations and all applicable policies and guidelines that Deerc may provide.

2. When using this product, please be sure to strictly abide by the specification requirements and safety guidelines stated in this document. Any personal injury, property damage, legal disputes and all other adverse events caused by the violation of any of the safety instructions or due to any other factor, WILL NOT be Deerc's responsibility.

2.0 SAFETY GUIDELINES

2.1 Check Before Use

- ① This product is a high precision drone that integrates various electronic stability and control mechanisms. Please be sure to configure this drone carefully and correctly to ensure safe, accident-free operation.
- ② Ensure that the batteries of the drone and transmitter are clean, undamaged, and fully charged before every use.
- ③ Ensure that all the propellers are undamaged and are installed in the correct orientation.

④ Please perform a thorough check of the product before each use. Inspect the integrity of the parts, any signs of cracks and wear off on the propellers, battery power and effectiveness of the indicator, etc. If there is any problem found after checking the drone, please refrain from using it until the problem is resolved.

2.2 Flight Environment



+



+



Fly in Open Areas

**Maintain Line
of Sight**

**Fly Below
131 feet (40 m)**



Avoid flying over or near obstacles, crowds, high voltage power lines, trees, airports or bodies of water.

DO NOT fly near strong electromagnetic sources such as power lines and base stations as it may affect the onboard compass.



DO NOT use this drone in adverse weather conditions such as rain, snow, fog, and wind.

2.3 Operations Requirements

- ① DO NOT use this product to follow any moving vehicles.
- ② During the flight, turn off the motors only in case of an emergency.
- ③ When the battery runs low, return the drone back to your starting point.
- ④ DO NOT use this product if you feel tired, take medicine or feel unwell and drink alcohol.
- ⑤ Be aware of the volume of noise that the drone produces. Please ensure to keep your distance to avoid ear damage.



- ⑥ **Stay away from the rotating propellers and motors.**





- ⑦ **DO NOT fly in any spaces where drones are prohibited. Please respect people's right to privacy by not flying your drone close to others.**

2.4 Use of Battery

- ① Please ensure batteries are fitted in the correct orientation as shown in the instruction manual.
- ② Avoid short circuits by fitting the batteries correctly, and do not crush or squeeze the batteries as this could cause the risk of a fire or explosion.
- ③ DO NOT mix new and old batteries as this can lead to poor performance of the product.
- ④ Please dispose of used batteries carefully, do not litter, and recycle where ever possible.
- ⑤ DO NOT expose dead batteries to heat or fire or they may explode.









- ⑥ If the device is not going to be used for an extended period of time, please remove batteries to prevent potential damage to the drone from battery leakage.
- ⑦ Only use the USB charging cable that comes with the drone to charge the battery.
- ⑧ DO NOT connect the battery directly to wall outlets or car cigarette -lighter sockets as this will damage your battery since they have different voltage.
- ⑨ DO NOT attempt to disassemble or modify the battery in any way.
- ⑩ DO NOT use the battery if it gives off an odor, generates heat, becomes discolored, deformed or appears abnormal in any way. If any of these situations occur while the battery is in use or being charged, remove it from the device or charger immediately and discontinue use.
- ⑪ DO NOT pierce the battery casing with a nail or any other sharp object, break it open with a hammer, or step on it! Dispose or recycle this battery as it may cause personal injury or damage to your drone.
- ⑫ Always charge the batteries on a fireproof surface and away from combustible materials. DO NOT charge on surfaces that can catch fire, which includes wood, cloth, carpet.
- ⑬ DO NOT immerse the battery in water or get it wet.
- ⑭ DO NOT solder battery terminal in any way.
- ⑮ Keep batteries out of reach of children or pets.
- ⑯ DO NOT short-circuit the battery by connecting wires or any other metal object to the positive(+) and negative(-) terminals.

	<p style="text-align: center;">Li-Po Battery Disposal & Recycling</p> <p>Waste Lithium-polymer batteries must not be placed with household trash. Please contact local environmental or waste agency or the waste agency or the supplier of your model or your nearest Li-Po battery recycling center.</p>	
---	---	---

3.0 MAINTENANCE

- ① Clean the drone after each use with a clean, soft cloth.
- ② Avoid prolonged exposure to direct sunlight and avoid buildup of heat on the drone or batteries.
- ③ This device is not waterproof and must not be submerged or subjected to water under any circumstance. Failure to keep the device completely dry will result in the failure and permanent damage to the unit. Be aware that although it might be dry where you are, droplets of rain or mist from a river or waterfall could damage your drone where it is flying.
- ④ Frequently check the charging plug and other accessories for signs of damage. If any part of the device or cables are damaged, avoid use or charging until the damaged parts is replaced.

4.0 PACKAGE CONTENTS

		
Drone	Transmitter	Drone Battery
		
USB Charging Cable	Propeller Guard	Propeller
		
Screwdriver	Instructions For Use	

5.0 DRONE DETAILS

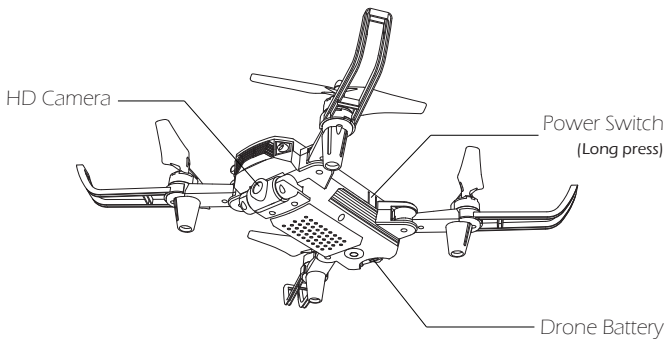
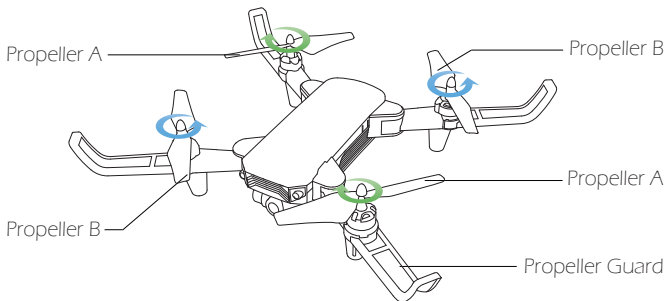

6.0 TRANSMITTER DETAILS

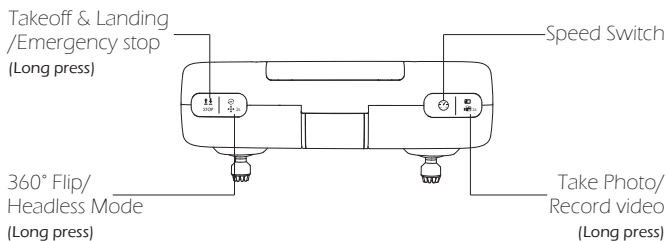
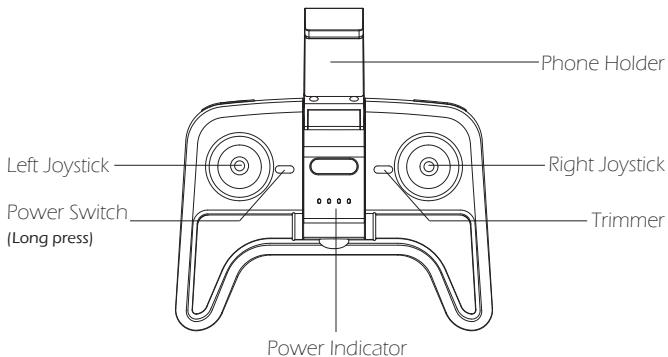

7.0 JOYSTICK MODE

7.1 MODE 2 (Default Setting)

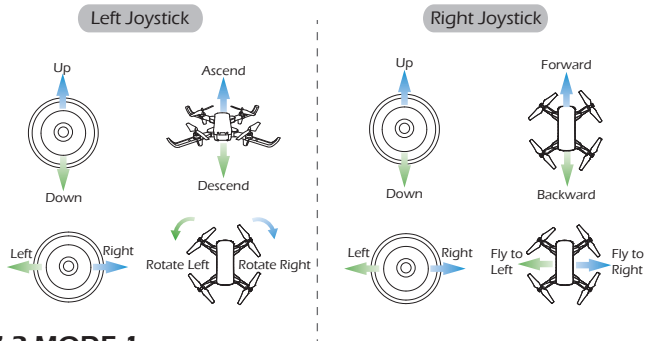

7.2 MODE 1

To enter MODE 1, turn on the transmitter while holding the “Speed Switch” button. **(Please do not release the “Speed Switch” button until the transmitter is powered on.)**

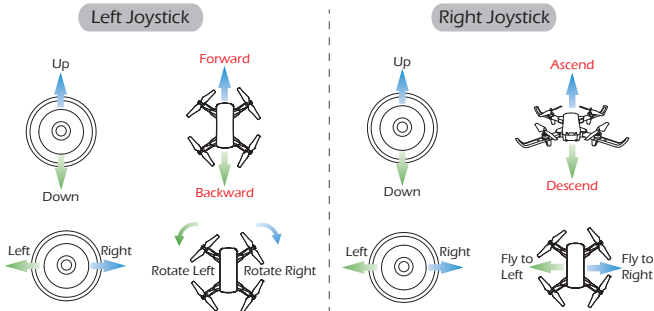

8.0 CHARGING

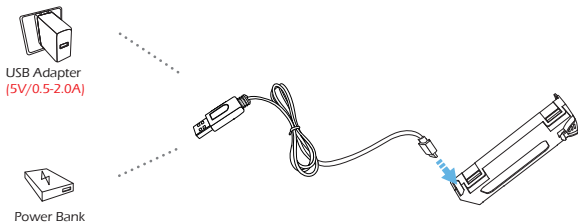

- 1) When the drone battery runs low, the indicator lights on the drone will blink continuously. About one minute the drone will automatically land on low battery power.
- 2) Remove the battery and connect the USB charging cable to the battery charging interface.
- 3) Plug the USB charging cable into a USB charging port on power bank or USB adapter (5V/0.5-2A).
- 4) The red indicator light on the USB charging cable will turn on when the battery is charging, and will turn off when the battery is fully charged.
- 5) Charging time: about 80 minutes.

⚠ Before charging, please read the instruction of the “Use of Battery” section of the “Safety Guidelines” carefully!

9.0 INSTALLATION

9.1 Propeller

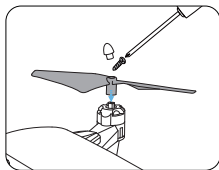
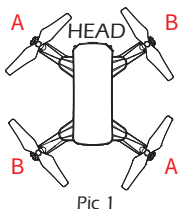

- ① Install the propeller on the motor shaft according to the "A/B" corresponding position. (Pic 1)
- ② Use a screwdriver to twist and tighten the screw by pressing the clockwise direction. (Pic2)

9.2 Propeller Guard

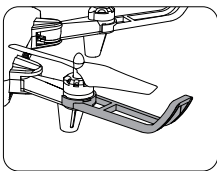
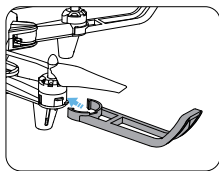

As shown in the picture, install the propeller guard to the motor base. Make sure that the propeller guard are clamped to the motor base to avoid the unnecessary loss and damage during flight.

9.3 Drone Battery

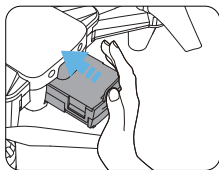

Pic 3

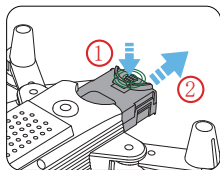

Pic 4

Installation: Push the battery correctly into the drone battery compartment. Make sure the battery is in place to ensure that the battery is jammed in the battery compartment. (Pic3)

Removal: Press the lock on the bottom of the battery and pull it back to remove the battery from the fuselage. (Pic4)

9.4 Camera Angle Adjustment

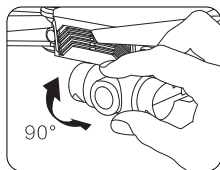

By rotating the drone's camera manually, the shooting angle of camera will be adjusted. Please adjust the angle according to the using situation. (The camera has an 90° tilt range.)

9.5 Transmitter Battery

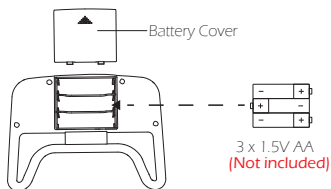

As shown above, insert the battery into the transmitter. Please pay attention to the positive and negative polarity of the battery to ensure the correct installation of the battery.

When the transmitter battery runs low, the power indicator of the transmitter will blink continuously.

9.6 Phone Holder

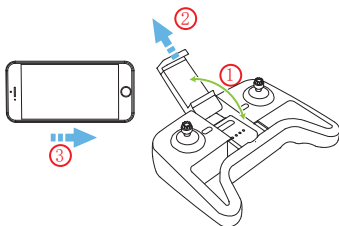

As shown above, open the Phone Holder and put the phone. Then you can use the FPV real-time transmission function.

10.0 OPERATION GUIDE

10.1 Download APP



iOS



Android APP on Google play

Scan the QR code, connect to the App Store™ or Google™ Play and download the “**DE FPV**” application for free.

Required Operating Systems: iOS 9.0 or later/Android 5.1 or later

10.2 Connect to Wi-Fi

Connect your phone to the Wi-Fi network created by the drone. You can check the drone’s status on the **DE FPV** App.

① Make sure to turn off Bluetooth, Mobile Data, and VPN. Enter your phone’s Wi-Fi settings and click Wi-Fi to search for the Wi-Fi of the drone. (Make sure to turn on the drone before going to the Wi-Fi settings on your phone)

② Select the Wi-Fi network: **DeercFPV-*******.

③ Wait for a couple of seconds for your phone to connect to the drone’s Wi-Fi.

④ Enter the **DE FPV** application.

> The connection between your phone and the drone is established automatically.

Attention: The Wi-Fi network created by the drone does not access the Internet.

All of the operations shown in this manual are demonstrated using **MODE 2**.

10.3 Pairing

① Press and hold the Power Button for 3 seconds to turn on the drone and the indicator lights on the drone begins to flash.

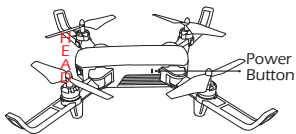

② Place the drone on a flat and level surface with the head forward and the tail towards the pilot.

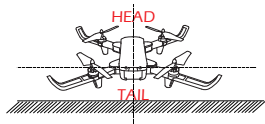

③ Long press the Power Button (ON/OFF) on the transmitter to turn it on and you will hear "Di", then the indicator light on the transmitter begins to flash.

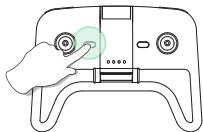

④ Push the left joystick up then down to pair the drone with the transmitter. The indicator lights on the drone and transmitter will turn solid if the drone is paired successfully.

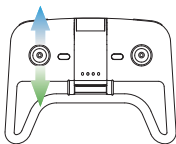

10.4 Calibrating the Gyro

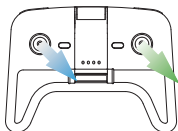

Push both joysticks down to the bottom right to calibrate the gyro. The indicator lights on the drone will blink quickly and turn solid, indicating calibration is completed.

Tip: To ensure a stable flight, we suggest that the pilot calibrates the gyro every time after pairing the drone and after a crash.

10.5 Takeoff

There are two methods for the drone to take off.

Method 1:

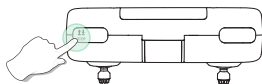

Short Press

Method 2:

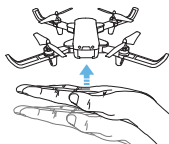

Method 1: After calibration, short press the Takeoff/landing () button, the drone will automatically take off and hover at 5 ft altitude. At this time, you can control this drone by using the joysticks.

Method 2: After calibration, pick up the drone and lay it flat on your palm. Gently toss the drone into the air, and it will hover in place.

10.6 Landing

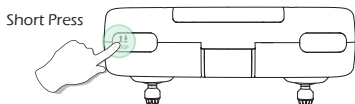



During the flight, short press the Takeoff/landing () button, the drone will land on the ground automatically.

11.0 FUNCTIONS DETAILS

11.1 Emergency Stop

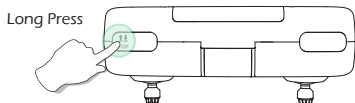
 The Emergency Stop function should only be used in case of emergency during the flight to avoid any damage or injury.



Press and hold the Emergency Stop button () of the transmitter for 2 seconds, the motors will stop immediately. Be aware that you risk breakage of the drone if it falls a large distance or hits anything at a high rate of speed.

11.2 Trimmer Function

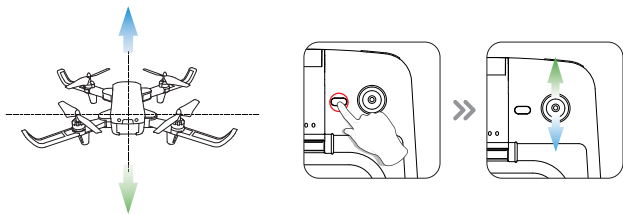

F/B Sideways Drift Trim: Short press the Trimmer button (**Trim**) to enter the Trimmer function. If the drone drifts forward, push the right joystick down to balance the drone. If the drone drifts backwards, push the right joystick up to balance the drone.

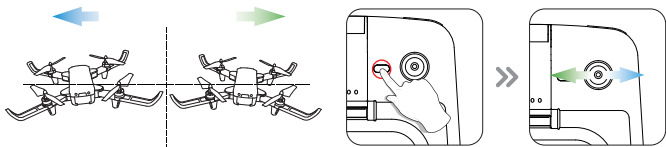

L/R Sideways Drift Trim: Short press the Trimmer button (**Trim**) to enter the Trimmer function. If the drone drifts left, push the right joystick right to balance the drone. If the drone drifts right, push the right joystick left to balance the drone.



- When you hear a long beep from the transmitter, it indicates that it has been adjusted to the limit.
- If you do not push the right joystick after entering the Trimmer function, the drone will automatically exit the Trimmer function after about two seconds.

11.3 Take Photo/Video

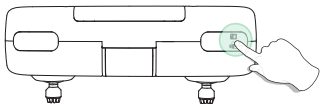

Take Photo:

Press the Photo/Video button () on the transmitter to take pictures. One beep can be heard from the transmitter, and the light flashes once indicating the camera has successfully taken a picture.

Record Video:

Press and hold the Photo/Video button () on the transmitter for 2 seconds, one long beep from the transmitter will be heard and the indicator lights will flash twice. This tells you that the camera has started recording video. You can exit the recording by long pressing the same button again.

11.4 Speed Switch

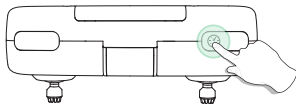



This drone comes with 3 speed modes (Low/Medium/High). Short press the Speed Switch button () on the transmitter to switch the speed.

A “Di” indicates Low speed, a “DiDi” indicates Medium speed and a “DiDiDi” indicates High speed.

(The Low Speed is the default speed mode.)

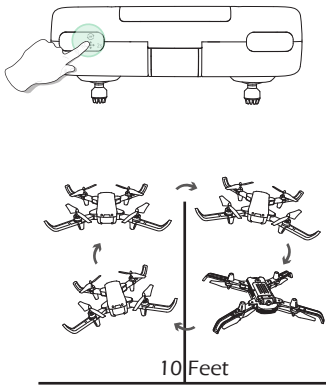
11.5 360° Flip



When you get familiar with all the functions of the drone, you can try this amazing flip mode. When you fly the drone at least 10 feet, short press the 360° Flip button () on the transmitter, then push the right joystick Forward/Backward or Left/Right, and the drone will do a flip towards the corresponding direction.

If you are in MODE 1, push the right joystick Left/Right or push the left joystick Forward/Backward, and the drone will do a flip towards the corresponding direction.

Tip: This function will perform better when the battery is fully charged.

1 1.6 Headless Mode

1. After pairing/calibration, long press the the Headless Mode button ( 2s) on the transmitter to enter the Headless Mode. The indicator lights on the drone continue to flash to indicate that it is in Headless Mode.
2. Press the Headless Mode button again, and you will hear a beep, the indicator lights on the drone will turn solid which indicates the drone exits the Headless Mode.

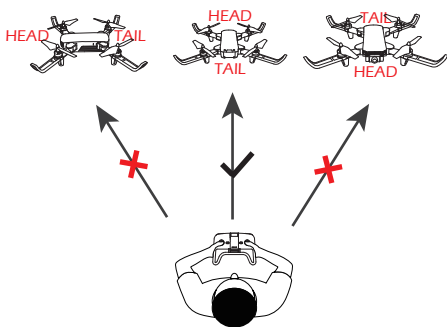

Please make sure the pilot to stay in the same orientation as the drone head faces when the drone is pairing.

While in Headless Mode, pushing the right joystick forward will make it fly in the direction that the head of the drone faces when the drone is pairing. To make sure the pilot can tell drone's direction, during the flight, we recommend that pilot stays facing the same direction that the drone head faces at pairing. By doing so it is ensured that when the pilot pushes the right joystick forward/backward, the drone will fly forward/backward toward him/her. If the pilot moves the right joystick left/right, the drone will move left/right relative to him/her.

12.0 SPECIFICATIONS

- DRONE

Model: D20

Weight: 69g/2.4oz

Max Flight Time: 10 minutes (per battery)

Motor Model: 716

Operating Temperature Range: 14° to 104°F (-10° to 40°C)

Size: 178*117*42 mm(Unfolded)

94*90*42 mm(Folded)

- DRONE BATTERY

Capacity: 500mAh

Voltage: 3.7V

Battery Type: Lithium-ion Polymer Battery

Charging Temperature Range: 41° to 104°F (5° to 40°C)

Charging Time: about 80 minutes (depends on charging power and remaining battery power)

- **TRANSMITTER**

Operating Frequency: 2452-2474MHz

Max Flight Distance: 131 feet/40m (outdoors and unobstructed)

Operating Temperature Range: 14° to 104°F (-10° to 40°C)

Battery Type: 1.5V AA Battery

- **CAMERA**

Operating Frequency: 2417MHz

Lens Angle: 80°

Video/Photo Resolution: HD1280 x 720P

Max Transmission Distance: 98 feet/30m (outdoors and unobstructed)

Photo Formats: JPEG

Video Formats: AVI/MP4

USB CHARGING CABLE

- Input: 5V/0.5-2A

Rated Power: ≤10W

13.0 TROUBLE SHOOTING

Problems	Reasons	Solutions
The indication lights of the drone are flashing and does not respond to the transmitter.	1. Communication between the drone and transmitter is not correct. 2. Battery power is low.	1. Refer to the preparation for flight and pair again. 2. Recharge the battery.
The propellers spin but the drone is unable to take off.	1. The propellers are assembled in wrong orientation. 2. The propellers are damaged.	1. Replace the propellers according to the motors. 2. Replace the propellers
The drone shakes hardy in flight.	The propellers are damaged.	Replace the propellers
The drone becomes out of control after crashing.	Gyro sensor lose it's balance after crashing.	Place drone on a level surface and re-calibrate the gyro.

14.0 CONTACT US

Please do not hesitate to contact us if you need further support.

 4:00 PM ~ 7:00 AM (PST)

 usa@deerc.com (USA)
eu@deerc.com (EU)

 +1(855)777-8866



For online support, please scan this code with Live Chat

15.0 GENERAL INFORMATION

FCC Notice:

This device complies with Part 15 of the FCC Rules.

Operation is subject to the following two conditions:

- (1) This device may not cause harmful interference, and
- (2) This device must accept any interference received, including interference that may cause undesired operation.

The Supplier's Declaration of Conformity is available at the following address:

https://www.deerc.com/Download/US/D20_FCC_sDoC.pdf.

NOTE: This equipment has been tested and found to comply with the limits for a Class B digital device, pursuant to Part 15 of the FCC Rules. These limits are set to provide reasonable protection against harmful interference in a residential installation. This equipment generates uses and can radiate radio frequency energy and, if it isn't installed and used in accordance with the instructions, may cause harmful interference to radio communications. However, there is no guarantee that interference will definitely disappear after a particular installation. If this equipment does cause harmful interference to radio or television reception, which can't be determined by turning the equipment off and on, the user is encouraged to try one or more of the following measures:

- Reorient or relocate the receiving antenna.
- Separation between more distance the equipment and receiver.
- Connect the equipment to an outlet on a circuit different from the receiver.
- Consult the dealer or an experienced radio/TV technician for help.

WARNING: Changes or modifications not expressly approved by the party responsible for compliance could void the user's authority to operate the equipment.

RF Exposure

The equipment complies with FCC radiation exposure limits set forth for an uncontrolled environment. This device should be installed and operated with a minimum distance of 20cm between the radiator & your body.

IC Notice:

This device complies with Canada Industry licence-exempt RSS standard(s).

Operation is subject to the following two conditions:

- (1) this device may not cause interference; and
- (2) this device must accept any interference. Including interference that may cause undesired operation of the device.

CAN ICES-003 (B)

Avis d'Industrie Canada

Le présent appareil est conforme aux CNR d'industrie Canada applicables aux appareils radio exempts de licence. L'exploitation est autorisée aux deux conditions suivantes:

- 1) l'appareil ne doit pas produire de brouillage; et
 - 2) l'utilisateur de l'appareil doit accepter le brouillage radioélectrique subi même si le brouillage est susceptible d'en compromettre le fonctionnement.
- Le mauvais fonctionnement de l'appareil. Cet appareil numérique de la classe B est conforme à la norme NMB-003 du Canada.

CAN NMB-003 (B)

RF Exposure

Radiation Exposure Statement:

This equipment complies with IC radiation exposure limits set forth for an uncontrolled environment. This equipment should be installed and operated with a minimum distance of 20cm between the radiator & your body.

Déclaration d'exposition aux radiations:

Cet équipement est conforme aux limites d'exposition aux rayonnements IC établies pour un environnement non contrôlé. Cet équipement doit être installé et utilisé avec un minimum de 20 cm de distance entre la source de rayonnement et votre corps.

HOW TO RECYCLE THIS PRODUCT

This symbol on the product or its documentation indicates that it must not be disposed of together with household waste.

Uncontrolled waste disposal may harm the environment or human health. Please separate your device from other types of waste for recycling it responsibly.

This will help to foster the sustainable re-use of material resources.

We invite you to contact your retailer or inquire at your local town hall to find out where and how the drone can be recycled.



BATTERY WARNING:

1. Failure to follow all the instructions may result in serious injury, irreparable damage to the battery and may cause a fire, smoke or explosion.
2. Always check the battery's condition before charging or using it.
3. Please replace the battery if the battery is dropped or has any peculiar smell, overheating, discolouration, deformation or leakage.
4. Never use anything other than the approved LiPo charger to charge the battery. Always use a balancing charger for LiPo cells or a LiPo cell balancer. It is recommended that you do not to use any other charger than the one provided with the product.
5. The battery temperature must never exceed 60°C (140°F) otherwise the battery could be damaged or ignite.

6. Never charge on a flammable surface, near flammable products or inside a vehicle (It's better to place the battery in a non-flammable and nonconductive container).
7. Never leave the battery unattended during the charging process. Never disassemble or modify the housing's wiring, or puncture the cells. Always ensure that the charger output voltage corresponds to the voltage of the battery. Do not short circuit the batteries.
8. Never expose the LiPo battery to moisture or direct sunlight, or store it in a place where temperatures could exceed 60°C (car in the sun, for example).
9. Always keep it out of reach of children.
10. Improper battery use may result in a fire, explosion or other hazard.
11. Non-rechargeable batteries are not to be recharged. Rechargeable batteries are only to be charged under adult supervision.
12. Different types of batteries or new and used batteries are not to be mixed.
13. Batteries are to be inserted with the correct polarity.
14. The supply terminals are not to be short-circuited. Regular examination of transformer or battery charger for any damage to their cord, plug, enclosure and other parts and they must not be used until the damage has been repaired.
15. The packaging has to be kept since it contains important information.
16. The toy is should only be connected to the equipment with symbol Class II.



EU RF Power(EIRP): <10 dBm (2452MHz ~ 2474 MHz)

Caution

- 1.The max operating of the EUT is 45°C. and shouldn't be lower than -10°C.
- 2.The device complies with RF specifications when the device used at 0mm form your body.
- 3.Declaration of Conformity

We, Xiamen Huoshiquan Import & Export CO.,LTD hereby, declare that the essential requirements compliance with the Directive 2014/53/EU, the RoHS Directive 2011/65/EU and Safety Directive 2009/48/EC have been fully fulfilled on our product with indication below:

Product Name: Remote control four axis series

Model/Mark: D20/DEERC

The Statement of compliance is available at the following address:

http://www.deerc.com/Download/CE/D20_EU_DOC.pdf

This product can be used across EU member states.

MANUFACTURER INFORMATION

Manufactured by

Xiamen Huoshiquan Import & Export Co.,LTD

Address: Unit 1, Room 501, Hongxiang Building, No.258 Hubin Nan Road, Siming District, Xiamen, China

+1(855)777-8866



MADE IN CHINA(CN)