

Instant Pot®

AIR FRYER LID



User Manual

Important safeguards

Product, parts and accessories

Get started

Control panel

Cooking

Care, cleaning and storage

Troubleshooting

Warranty

Contact

Download the Instant Pot App with 1000+ recipes at instantpot.com/app.



IMPORTANT SAFEGUARDS



(Yes, we have to)

At Instant Brands™ your safety always comes first. The Instant Pot® Air Fryer Lid was designed with your safety in mind, and we mean business. Check out its safety mechanisms at instantpot.com to see what we mean.

When using electrical appliances, basic safety precautions should always be followed:

- 01** READ THIS ENTIRE DOCUMENT BEFORE OPERATING THE APPLIANCE. FAILURE TO FOLLOW THESE SAFEGUARDS AND INSTRUCTIONS MAY RESULT IN INJURY AND/OR PROPERTY DAMAGE.
- 02** Only use the appliance with a compatible Instant Pot multi-use pressure cooker base. See **Compatibility** for a list of compatible products.
- 03** Overloading electrical circuits can lead to fire, burns and injury. **DO NOT** plug in the Air Fryer Lid and the Instant Pot multi-use pressure cooker base at the same time. Always unplug the Instant Pot cooker base **BEFORE** plugging in the Air Fryer Lid.
- 04** Do not use this appliance with Instant Pot ceramic coated inner pots. Use only with Instant Pot stainless-steel inner pots.
- 05** Unplug the appliance when not in use and before cleaning. To do so safely, press **Cancel** so display shows **OFF**, then grasp the plug and remove it from the wall outlet. Never pull from the power cord.
- 06** **DO NOT** attempt to use a Smart Program on the Instant Pot pressure cooker base for any function when the Air Fryer Lid is placed on top of base cooker.
- 07** Always check the cooker base for foreign objects before use.
- 08** Overfilling the inner pot may cause damage, fire and/or personal injury.
 - When using the pressure cooking lid,
 - **DO NOT** fill the inner pot and/or air fryer basket above the **PC MAX —2/3** line, or over the **—1/2** line when cooking foods that expand.
 - **DO NOT** use the broil/dehydrating tray.
 - When using the Air Fryer Lid,
 - **DO NOT** allow food to touch the element cover on the Air Fryer Lid.

⚠ WARNING

Read this manual carefully and completely and retain for future reference. Failure to adhere to safety instructions may result in serious injury or damage.

IMPORTANT SAFEGUARDS



- 09** Oversized foods must not be inserted into the stainless-steel inner pot or the air fryer basket as they may create a fire or risk of electric shock.
- 10** For household countertop use only. DO NOT use outdoors. Not for commercial use.
- 11** Always operate the appliance on a stable, non-combustible, level surface.
- 12** **⚠ CAUTION** Spilled food can cause serious burns. Keep the appliance and cord away from children.
- DO NOT let the power cord contact hot surfaces or open flame, including the stovetop.
 - DO NOT let the power cord hang over the edge of tables or counters.
 - DO NOT use power outlets below counters.
 - DO NOT use the appliance with an extension cord.
- 13** **⚠ CAUTION** To protect against the risk of electrical shock, DO NOT immerse the Air Fryer Lid, power cord or plug in water or other liquid. DO NOT rinse the appliance under a tap.
- 14** Regularly inspect the appliance and power cord. DO NOT operate the appliance if:
- The power cord or plug show signs of damage.
 - The appliance malfunctions.
 - The appliance is dropped or damaged in any manner.
- For assistance, contact Customer Care at support@instantpot.com, instantpot.com/#chat, or by phone at **1-800-828-7280**.
- 15** DO NOT use the appliance in electric systems other than 120 V ~ 60 Hz. DO NOT use with power converters or adapters.
- 16** Heat from an external source will damage the appliance.
- DO NOT place the appliance on any kind of stovetop or in a heated oven.
 - DO NOT rest the appliance on the power cord.

⚠ WARNING

Read this manual carefully and completely and retain for future reference. Failure to adhere to safety instructions may result in serious injury or damage.

IMPORTANT SAFEGUARDS



- 17 **⚠ CAUTION** The appliance's outer surfaces may become hot during use.
- DO NOT touch hot surfaces or try to reach through the element cover to touch the heating element or the fan.
 - Extreme caution must be used when moving the appliance. Only use the lid handle to lift and carry the Air Fryer Lid.
 - Only place the Air Fryer Lid on the protective pad provided; DO NOT place on countertop.
- 18 DO NOT cover or block the air vents while the appliance is in operation. Do not cover any part of the appliance with metal foil. This will prevent even cooking and cause damage to the appliance through overheating.
- 19 **⚠ CAUTION** When cooking, improper use may result in personal injury:
- DO NOT attempt to use the appliance for deep frying with oil.
 - DO NOT use the appliance without the removable stainless-steel inner pot in place, to reduce the risk of damaging the cooker base, causing fire and personal injury.
- 20 DO NOT heat the empty stainless-steel inner pot with the Air Fryer Lid for more than 10 minutes, as doing so may damage the cooking surface.
- DO NOT move the Instant Pot cooker base if the stainless-steel inner pot contains hot oil, hot food or hot liquids.
 - DO NOT place the appliance against a wall or against other appliances. Leave 5" / 13 cm of space around and above the appliance.
 - DO NOT operate the appliance on or near combustible materials such as tablecloths and curtains.
 - DO NOT cover or place objects on top of the appliance.
- 21 **⚠ CAUTION** While cooking, the stainless-steel inner pot and accessories become extremely hot. To avoid personal injury,
- DO NOT touch the inner pot or accessories during or immediately after cooking.
 - Always use proper hand protection when removing accessories and when handling the hot stainless-steel inner pot.
 - Always place hot accessories on a heat-resistant surface or cooking plate.
 - Use extreme caution when disposing of hot grease.

⚠ WARNING

Read this manual carefully and completely and retain for future reference. Failure to adhere to safety instructions may result in serious injury or damage.

IMPORTANT SAFEGUARDS



- 22 **⚠ CAUTION** When the Air Fryer Lid is in operation hot air is released through the air vents, which may result in personal injury. Keep your hands and face at a safe distance from the air vents. **DO NOT** place your face or hands over the appliance when removing the Air Fryer Lid.
- 23 If the Air Fryer Lid emits black smoke, press **Cancel** and unplug it immediately. Wait for smoking to stop before removing the Air Fryer Lid, then allow it to cool to room temperature and clean the lid and inner pot thoroughly.
- 24 **DO NOT** leave the appliance unattended while in use.
- 25 **DO NOT** connect the appliance to an external timer switch or separate remote-control system.
- 26 This appliance is **NOT** to be used by children or by persons with reduced physical, sensory or mental capabilities. Close supervision is necessary when any appliance is used near children and these individuals. Children should not play with this appliance.
- 27 Proper maintenance is recommended after each use. Let the appliance cool down to room temperature before cleaning or storing or when adding or removing parts and accessories. Refer to **Care, cleaning and storage**.
- 28 Avoid contact with moving parts.
- 29 **DO NOT** place flammable material in the inner pot, such as paper, cardboard or plastic.
- 30 The included accessories are not to be used in a microwave, toaster oven, convection or conventional oven, or on a ceramic, electric, induction or gas cooktop, or an outdoor grill.
- 31 **DO NOT** clean with metal scouring pads. Pieces can break off the pad and touch electrical parts involving a risk of electric shock.
- 32 **DO NOT** use any accessories or attachments not authorized by Instant Brands Inc. The use of attachments not recommended by the manufacturer may cause a risk of injury, fire or electric shock.

⚠ WARNING

Read this manual carefully and completely and retain for future reference. Failure to adhere to safety instructions may result in serious injury or damage.

IMPORTANT SAFEGUARDS



- 33 DO NOT attempt to repair, replace, alter or modify components of the appliance, as this may cause electric shock, fire or injury, and will void the warranty.
- 34 DO NOT tamper with any of the safety mechanisms.
- 35 DO NOT use the appliance for other than its intended use.

SAVE THESE INSTRUCTIONS.

⚠ WARNING

To avoid injury, read and understand the instructions in this user manual before attempting to use this appliance.

⚠ WARNING

Electrical shock hazard. Use grounded outlet only.

- DO NOT remove ground.
- DO NOT use an adapter.
- DO NOT use an extension cord.

Failure to follow these instructions may result in electric shock and/or serious injury.

⚠ WARNING

THE FAILURE TO FOLLOW ANY OF THE IMPORTANT SAFEGUARDS AND/OR THE INSTRUCTIONS FOR SAFE USE IS A MISUSE OF YOUR APPLIANCE THAT CAN VOID YOUR WARRANTY AND CREATE THE RISK OF SERIOUS INJURY.

Special cord set instructions

As per safety requirements, a short power supply cord is provided to reduce the hazards resulting from grabbing, entanglement and tripping.

This appliance has a 3-prong grounding plug. To reduce the risk of electric shock, plug the power cord into a grounded (earthed) electrical outlet that is easily accessible.

⚠ WARNING

Read this manual carefully and completely and retain for future reference. Failure to adhere to safety instructions may result in serious injury or damage.

IMPORTANT SAFEGUARDS



Compatibility

The 6 Quart Air Fryer Lids are made for use with 6 Quart Instant Pot Multi-Use Pressure Cookers, respectively.

Duo 60 (IP-DUO60, IP-DUO60 V2, IP-DUO60 V2.1, IP-DUO60-ENW, IP-DUO60 V3, Duo 60 V3, Duo Frontier Rose 60, Duo Dazzling Dahlia 60, Duo White 60, Duo Teal 60, Duo Red 60, Duo Black SS 60, Duo Red SS 60, Duo Nova Black SS 60).

Lux 60 (IP-LUX60, Lux Blue 60, Lux Red 60, IP-LUX60 V2, IP-LUX60-ENW, IP-LUX60-ENW-MM, IP-LUX60 V3, Lux Breezy Blossoms 60, Lux Vintage Floral 60, Lux Black SS 60, Lux Red SS 60, Lux 60 V3).

Duo Plus 60 (Duo Plus 60, Duo Plus Cinnamon SS 60, Duo Plus Blue SS 60, Duo Plus Copper SS 60, Duo Plus Black SS 60). Ultra 60 (Ultra 60).

Viva 60 (Viva, Viva 60, Viva Cinnamon 60, Viva Cobalt 60, Viva Eggplant 60, Viva Red SS 60, Viva Black SS 60).

Nova Plus 60 (Nova Plus 60). Duo Nova 60 (Duo Nova 60).

The Air Fryer Lid is NOT compatible with the following models:

Smart WiFi 60, Duo Evo Plus 6, Duo Evo Plus 60, Duo SV 60 and Max 60.







Exclusively for use with Instant Pot stainless-steel inner pots. To avoid property damage, never use with ceramic-coated inner pots.

If you aren't sure which Instant Pot model you have, get in touch with a Customer Care Advisor through our chat widget at instantpot.com/#chat, by email at support@instantpot.com or by phone at **1-800-828-7280**, and we'll happily help figure it out!

Find your model name and serial number

Find both of these on the label on the back of the Air Fryer Lid, near the power cord.

Product specifications

					
Air Fryer Lid 6	1500 W	120 V ~ 60 Hz	6 Quart 5.7 Litres	5.95 lbs / 2.7 kg	in: 10.7 L x 11.6 W x 6.14 H cm: 27.2 L x 29.5 W x 15.6 H

WARNING

Read this manual carefully and completely and retain for future reference. Failure to adhere to safety instructions may result in serious injury or damage.

Table of contents

IMPORTANT SAFEGUARDS	2
Special cord set instructions.....	6
Compatibility	7
Find your model name and serial number	7
Product specifications	7
Product, parts and accessories	9
Get started	11
Initial set up (it won't bite!)	11
Is something missing or damaged?	11
Control panel	12
Settings.....	13
Status messages	14
Cooking	15
Using the accessories.....	16
Air Fry, Broil, Bake and Roast.....	18
Dehydrate and Reheat	21
Care, cleaning and storage	23
Storing the Air Fryer Lid	24
Troubleshooting	25
Warranty	26
Contact us	28

Product, parts and accessories

Air Fryer Lid 6 Quart

Before using your awesome new lid, make sure that everything is present and accounted for.

Front

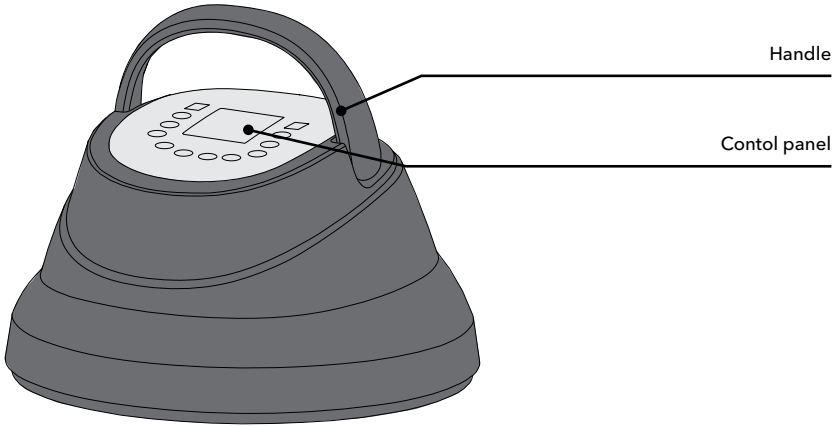

Back

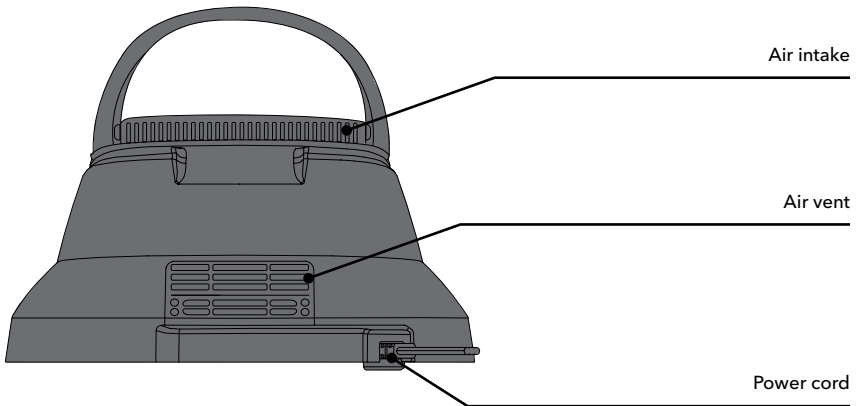

*Illustrations in this document are for reference only and may differ from the actual product.
Always refer to the actual product.*

Product, parts and accessories

Interior

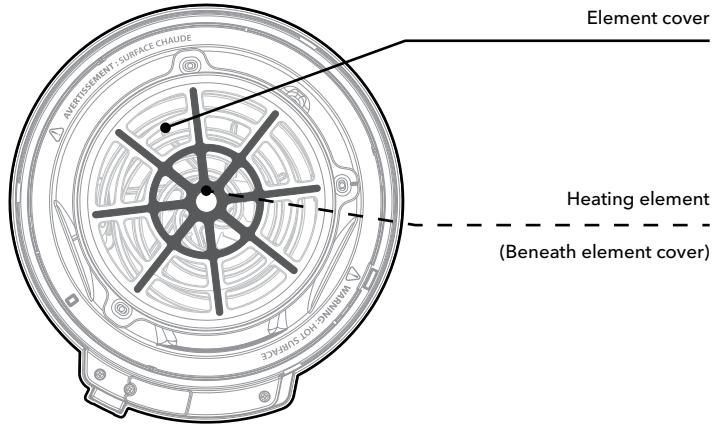

Accessories

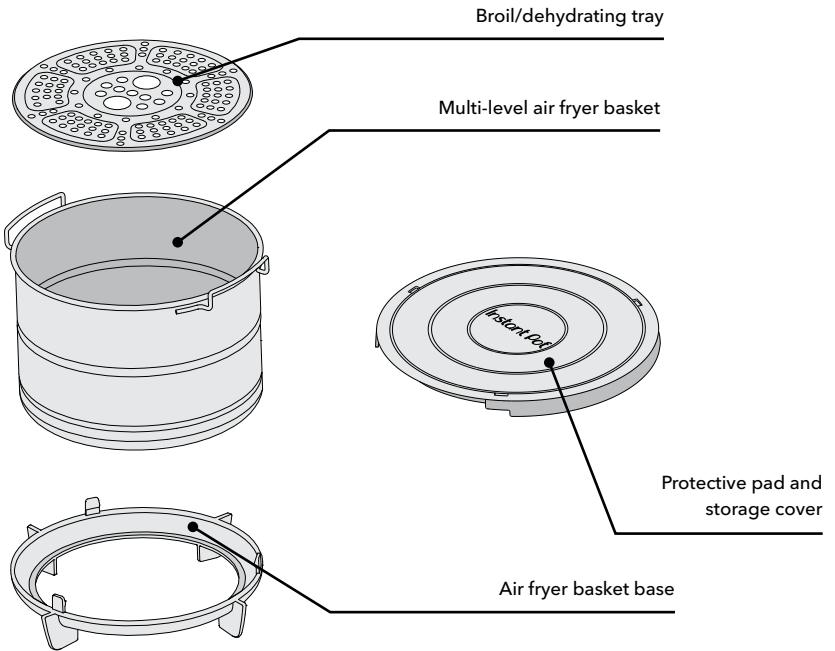

Illustrations in this document are for reference only and may differ from the actual product. Always refer to the actual product.

Get started

Initial set up (it won't bite!)

 **"Cooking is like love. It should be entered into with abandon or not at all."**
– Harriet Van Horne

- 01** Pull that Air Fryer Lid out of the box!
 - 02** Remove the packaging material and accessories from in and around the cooker and make sure all the parts are accounted for. See **Product, parts and accessories** for a full parts breakdown.
 - 03** Follow the **Care, cleaning and storage** instructions to wash the Air Fryer Lid and accessories before first use.
-  Don't remove the safety warning stickers from the lid or the rating label from the back of the cooker base.
- 04** Make sure to only use the Instant Pot Air Fryer Lid with a compatible Instant Pot multi-use pressure cooker and stainless-steel inner pot. See **Compatibility** for the full list of Instant Pots that work with this Air Fryer Lid.

Is something missing or damaged?

Get in touch with a Customer Care Advisor through our chat widget at instantpot.com/#chat, by email at support@instantpot.com or by phone at **1-800-828-7280** and we'll happily make some magic happen for you.

WARNING

Overloading electrical circuits can lead to fire, burns and injury. DO NOT plug in the Air Fryer Lid and the cooker base at the same time. Always unplug the cooker base BEFORE plugging in the Air Fryer Lid to avoid personal injury and/or property damage.	To avoid personal injury and/or property damage, only place the appliance on the protective pad provided or on a compatible Instant Pot cooker base. DO NOT place the appliance on a stovetop. Heat from an external source will damage the appliance.	Leave at least 5" / 13 cm of space around the appliance, and do not block or cover the air vents to avoid personal injury and/or property damage.
--	---	---

NOTICE

Read the **Important safeguards** before using the appliance. Failure to read and follow those instructions for safe use may result in damage to the appliance, property damage or personal injury.

Control panel

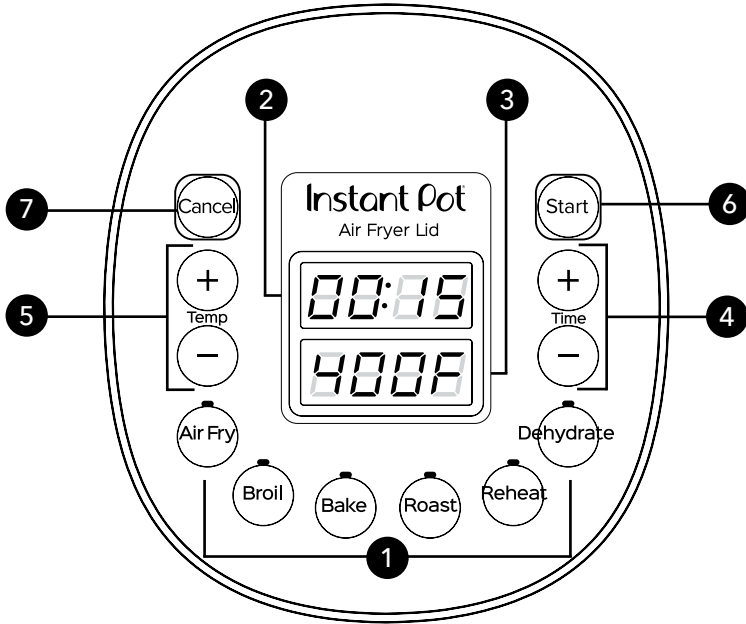

1	Smart Programs	<ul style="list-style-type: none"> • Air Fry • Broil • Bake • Roast • Reheat • Dehydrate
2	Time display	The time display shows the time in HH:MM format. It counts up or down, depending on the Smart Program.
3	Temperature display	The temperature display shows the set temperature in °C or °F.
4	+ / - Time	Press to adjust the time.
5	+ / - Temp	Press to adjust the cooking temperature in °C or °F.
6	Start	Begins the selected Smart Program.
7	Cancel	Stop a Smart Program at any time.

Illustrations in this document are for reference only and may differ from the actual product. Always refer to the actual product.

Control panel

Settings

To do this...	Do this!
Change the temperature scale (°F and °C).	When in standby, press and hold the + button over Temp until Fahrenheit (°F) or Celsius (°C) appears on the display.
Turn sounds on and off.	Sound On: When in Standby mode, press and hold the + button over Time until S On appears on the display. Sound Off: When in Standby mode, press the - button beneath Time until SOFF appears on the display.  Error alerts cannot be silenced.
Adjust and save custom cooking times and temperatures.	Once a Smart Program is selected, changes to the cooking time and temperature are saved once the Smart Program begins.
Reset an individual smart program.	When in standby, press and hold one Smart Program button until the appliance beeps. The Smart Program has been restored to the factory default setting.
Reset all smart programs.	When in standby mode, press and hold Cancel until the appliance beeps. All Smart Programs have been restored to the factory default settings.

Status messages

<i>OFF</i>	The Air Fryer Lid is in standby mode, ready for action!
<i>On</i>	Air Fryer Lid has started preheating.
<i>Lid</i>	This may indicate: <ul style="list-style-type: none">• The lid is not seated properly.• The inner pot is not present in the cooker
<i>Add Food</i>	The Air Fryer Lid has reached the perfect temperature, and is ready to cook your food.
<i>Turn Food</i>	Food in the inner pot should be turned, flipped or rotated, as your recipe recommends.
<i>Cool</i>	The fan is blowing to help cool the appliance.
<i>End</i>	The Smart Program has finished cooking.
<i>Food burn</i>	May indicate overheating in the inner pot. Refer to Troubleshooting .

Cooking

The Air Fryer Lid makes your Instant Pot multicooker even more versatile – whether you want to pressure cook first and use the Air Fryer Lid to crisp up your dish, or if you'd prefer to cook your meal just using the Air Fryer Lid – you can!

Depending on your recipe, you can use the multi-level air fryer basket or any oven-safe cookware to cook or crisp your meal, or, you can place food right in the inner pot. Just make sure you always have the stainless-steel inner pot inserted first!

See **Using the accessories** on the next page for details.

NOTICE

If the **Food burn** error appears while using the air fryer lid, deglaze the bottom of the inner pot as described in your Instant Pot user manual.

⚠ CAUTION

DO NOT use a non-stick ceramic coated inner pot to avoid property damage.

Do not overfill the inner pot or accessories. To prevent risk of fire, damage and/or personal injury, ensure that food does not contact the heating element or the element cover.

The inner pot and accessories will be hot during and after cooking. To avoid injury, do not touch the hot inner pot or accessories with unprotected hands.

⚠ WARNING

Overloading electrical circuits can lead to fire, burns and injury. DO NOT plug in the Air Fryer Lid and the Instant Pot cooker base at the same time. Always unplug the Instant Pot cooker base BEFORE plugging in the Air Fryer Lid.

Cooking

Using the accessories

The multi-level air fryer basket is perforated to help give your food a delicious all over crisp, and should be used for most air fried foods, like wings, nuggets and cauliflower bites.

You can get different results by changing the air flow in the inner pot.

Do this...	And get something like this!
Place food directly in the inner pot for cooking.	Golden and crispy on top, but the air won't flow easily around the bottom if the inner pot so the sides. Juices from cooking may cause the bottom to retain a soggy texture.  Perfect for chicken, less ideal for spring rolls!
Place food in the bottom of the multi-level air fryer basket.	Golden and crispy on the top and sides. Juices from cooking drip off so the bottom crisps up.
Place food in the bottom of the multi-level air fryer basket, then cover with the broil/dehydrating tray.	The air flow is diverted, so you will get less crisp. Great for dehydrating!
Place food on the broil/dehydrating tray.	Your food gets up close and personal with the heating element and crisps a lot faster. Perfect for melting cheese or giving your meal that golden finishing touch.

 Instant Tip: Don't crowd the multi-level air fryer basket or the broil/dehydrating tray. Air must be able to circulate freely around food.

Cooking

Assemble the multi-level air fryer basket

- 01 Place the air fryer basket base on a stable surface.

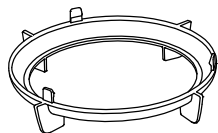

- 02 Position the multi-level air fryer basket over the base and press down firmly. The teeth on the base should pop into the groove on the outside of the basket.

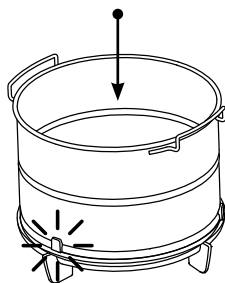

- 03 If you want to use the broil/dehydrating tray, insert it into the multi-level air fryer basket with the smooth side up.

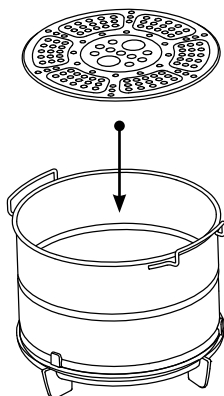

-  To easily maneuver the broil/dehydrating tray, lift it with two fingers from the large holes in the middle of the tray. To prevent personal injury, make sure to only handle the accessories when they are cool.

Cook first, crisp later

To cook your food before using the Air Fryer Lid:

- 01 Insert your food into the stainless-steel inner pot, then insert the inner pot into a compatible Instant Pot cooker base.

-  See **Compatibility** for the full list of Instant Pots that work with this Air Fryer Lid.

- 02 Follow cooking instructions from your user manual.

- 03 When cooking ends (and you have released all pressure, if pressure cooking) remove the pressure cooker lid.

- 04 Unplug the Instant Pot as directed in your user manual.

-  Always unplug the Instant Pot cooker base **BEFORE** plugging in the Air Fryer Lid.

Cooking

Air Fry, Broil, Bake and Roast

Elevate your meal's taste and texture with the Air Fryer Lid!

Smart program	Default time*	Time range	Default temperature*	Temperature range
Air Fry	20 minutes (00:20)	1 to 45 minutes (00:01 to 00:45)	204°C 400°F	149 to 204°C 300 to 400°F
	<p>Air frying is an amazing way to bring out a lot of flavor using only a little oil. Crisp up previously cooked dishes or use the Air Fryer Lid to cook a dish from start to finish.</p> <p>Ideal for fresh or frozen fries, chicken wings, shrimp and more.</p>			
Broil	10 minutes (00:10)	1 minute to 20 minutes (00:01 to 00:20)	204°C 400°F	Not adjustable.
	<p>Broiling involves direct top-down heating, and broiled foods benefit from being placed close to the element.</p> <p>Perfect for melting cheese on French onion soup.</p>			
Bake	30 mins (00:30)	1 minute to 1 hour (00:01 to 01:00)	185°C 365°F	82 to 193°C 180 to 380°F
	<p>Like a tiny oven, the Bake Smart Program can be used to create decadent brownies, fluffy cakes, pastries, buns and much more.</p> <p>Bake with the provided multi-level air fryer basket or any oven-safe baking dish, such as a springform pan. Unless specified in your recipe, do not cover your batter when baking.</p> <p>If baking in the air fryer basket, line the interior of the air fry basket with aluminum foil or parchment paper, then pour in loose batter.</p> <p>If using a baking dish, make sure to elevate the dish with a steam rack when cooking.</p>			
Roast	40 mins (00:40)	1 to 45 minutes (00:01 to 00:45)	193°C 380°F	121 to 193°C 250 to 380°F
	<p>The Roast Smart Program is perfect for beef, lamb, pork, poultry, vegetables and more.</p> <p>Give your roast a beautiful crust, crisp up poultry skins or give your vegetables a golden exterior.</p>			

* Smart Program times and temperatures are recommendations only. Always follow a trusted recipe, as time and temperature will vary based on food type and quantity.

Cooking

Stage 1: Setting up for cooking

01 Make sure your Instant Pot is unplugged, then connect the Air Fryer Lid's power cord to a 120 V power source.

02 Place the Air Fryer Lid on the protective pad for now.

03 Insert the stainless-steel inner pot into the cooker base of a compatible Instant Pot.

 See **Compatibility** for the full list of Instant Pots that work with this Air Fryer Lid.

04 Place the Air Fryer Lid on the cooker base. When the lid is placed correctly, the display shows **OFF** and the cooker plays a little jingle!

05 Select a Smart Program: **Air Fry, Broil, Bake** or **Roast**.

06 Use the **+ / - Temp** buttons to adjust the cooking temperature.

07 Use the **+ / - Time** buttons to adjust the cook time.

 Smart Programs automatically save the adjustments you make to the temperature and time settings when you press Start.

08 Press **Start** to begin!

The display shows **On** as the Air Fryer Lid preheats.

 You can adjust the time or temperature any time with the **+ / -** buttons (then press **Start** to confirm the change) but changes made after the Smart Program begins are not saved.

Stage 2: Getting your food ready for cooking

01 As it preheats, see **Using the accessories** to choose the best accessory for the cooking you need to do, and prepare your food as needed.

02 When the Air Fryer Lid reaches the perfect temperature, the display shows **Add Food**, then changes to the cooking time and starts the countdown.

You can put food in the inner pot before or after preheating, as your recipe recommends. Cooking will start 10 seconds after the notification appears, whether food has been added or not.

03 Carefully lift the Air Fryer lid off the cooker base and place it on the protective pad.

Lifting the lid pauses cooking.

 Using proper hand protection, carefully insert the food or cooking accessory to the inner pot.

Place the Air Fryer Lid on the cooker base to resume cooking.

⚠ CAUTION

If the Air Fryer Lid is not placed correctly, you will get a **Lid** or **C9** error. Failure to ensure a proper connection could result in damage to the cooker.

The inner pot and accessories will be hot during and after cooking. To avoid injury, do not touch the hot inner pot or accessories with unprotected hands.

Cooking

Stage 3: Cooking

01 During the Air Fry and Roast programs, the cooker beeps partway through cooking and the display shows **turn Food**.

 Some food doesn't need to be flipped. If you don't remove the lid after the turn food indicator appears, cooking continues after 10 seconds.

02 If you want to turn or toss your food, lift the lid off the cooker base and place it on the protective pad.

03 Carefully turn, flip, or rotate your food items, then place the air fryer lid back on the cooker base to resume cooking.

 If the lid is left off for longer than 3 minutes, it will go back to standby mode and display **OFF**.

04 When the Smart Program finishes, the display shows **End**.

The fan may keep blowing for up to 5 minutes or until you lift the lid.

 The Air Fryer Lid beeps to remind you that cooking has ended 5 minutes, 20 minutes, and 60 minutes after cooking finishes.

Cooking tips

Cook all your favorite fresh and frozen oven-baked and deep-fried snacks – fast!

- Preheating is an important step! Wait for the **Add Food** message to appear before adding food to the inner pot.
- For coated food, like onion rings or deep-fried pickles, use an egg wash with breadcrumbs rather than liquid-based batters to make sure that batter sticks to the food.
- Spray food items with cooking oil before adding seasoning to get the seasoning to stick well.
- For super crispy fries, soak your fresh-cut potato sticks in ice water for 15 minutes, then pat them dry and spray them lightly with oil before cooking.
- Patting dry moist food items before cooking prevents excess steam and splatter and gives you crispier results.

Check out the cooking timetables at instantpot.com/airfryerlid, download the Instant Pot app at instantpot.com/app, or, visit our recipe site at instantpot.com/recipes for fun, easy-to-follow recipes.

CAUTION

The inner pot and accessories will be hot during and after cooking. To avoid injury, do not touch the hot inner pot or accessories with unprotected hands.

CAUTION

Refer to the USDA's Safe Minimum Internal Temperature Chart at fsis.usda.gov/safetempchart or Health Canada's Cooking Temperatures Chart at canada.ca/foodsafety for more information.

Cooking

Dehydrate and Reheat

Smart program	Default time	Time range	Default temperature	Temperature range
Dehydrate	6 hours (06:00)	1 hour to 72 hours (01:00 to 72:00)	52°C 125°F	41 to 74°C 105 to 165°F
	The Dehydrate Smart Program applies low heat over a long period of time to safely dry out food items. Make fruit leather, dehydrated vegetable chips and all kinds of jerky. Always follow a trusted recipe when dehydrating meat.			
Reheat	15 minutes (00:15)	1 minute to 1 hour (00:01 to 01:00)	138°C 280°F	49 to 182°C 120 to 360°F
	Warm up meals without overcooking or drying them out.			

Stage 1: Getting your food ready

- 01** See **Using the accessories** to choose the best accessory for what you need to do, and prepare your food as needed.
 - 02** When you're ready, make sure your Instant Pot is **unplugged**, then connect the Air Fryer Lid's power cord to a 120 V power source.
 - 03** Place the Air Fryer Lid on the protective pad for now.
 - 04** Insert the stainless-steel inner pot into the cooker base of a compatible Instant Pot.
-  See **Compatibility** for the full list of Instant Pots that work with this Air Fryer Lid.

Stage 2: Setting up for dehydrating or reheating

- 01** Insert the food or cooking accessory to the inner pot.
- 02** Place the Air Fryer Lid on the cooker base.

When the lid is placed correctly, the display shows **OFF** and the cooker plays a little jingle.
- 03** Select a Smart Program: **Dehydrate** or **Reheat**.
- 04** Use the **+ / - Temp** buttons to adjust the cooking temperature.
- 05** Use the **+ / - Time** buttons to adjust the cook time.

Smart Programs automatically save the adjustments you make to the temperature and time settings when you press Start.

Cooking

Stage 3: The main event

01 Press **Start** to begin!

 You can adjust the time or temperature any time with the **+ / -** buttons (then press **Start** to confirm the change) but changes made after the Smart Program begins are not saved.

02 When the Smart Program finishes, the display shows **End**.

 The Air Fryer Lid beeps to remind you that cooking has ended 5 minutes, 20 minutes, and 60 minutes after cooking finishes.

CAUTION

The inner pot and accessories will be hot during and after cooking. To avoid injury, do not touch the hot inner pot or accessories with unprotected hands.

Care, cleaning and storage

Clean your Air Fryer Lid after each use. Failure to follow these cleaning instructions may result in catastrophic failure, which may lead to property damage, severe personal injury and/or death.

Always unplug the appliance and let it cool to room temperature before cleaning. Never use metal scouring pads, abrasive powders or harsh chemical detergents on any parts or accessories.

Let all surfaces dry thoroughly before use, and before storage.

Parts and accessories	Cleaning methods and instructions
<p>Multi-level air fryer basket</p> <ul style="list-style-type: none"> • Broil/dehydrating tray • Air fryer basket base 	<p>Dishwasher safe if placed on top rack, otherwise clean with a damp cloth and mild dish soap and rinse well with clear, warm water.</p> <ul style="list-style-type: none"> • Disassemble and clean after each use. • Optionally, spray the broil/dehydrating tray and/or basket interior with non-stick cooking spray before adding food.
<p>Protective pad and storage cover</p>	<p>Dishwasher safe if placed on top rack, otherwise clean with a damp cloth and mild dish soap and rinse well with clear, warm water.</p> <ul style="list-style-type: none"> • Use the reverse side of the protective pad to cover the Air Fryer Lid when storing.
<p>Air Fryer Lid</p>	<p>Clean with a barely-damp cloth and mild dish soap, then use a clean, barely-damp sponge to remove the soap residue. DO NOT wash or submerge in water or other liquid.</p> <ul style="list-style-type: none"> • Always check the element cover for oil spatter and food debris and remove it before turning on the air fryer lid. • To remove baked-on grease and food residue, spray the element cover with a mixture of baking soda and vinegar and wipe clean with damp cloth. • For stubborn stains, allow the mixture to sit on the affected area for several minutes before scrubbing clean. <p> Make sure not to use anything more abrasive than a toothbrush to scrub the element cover.</p> <ul style="list-style-type: none"> • DO NOT remove the element cover. • DO NOT rinse or immerse the Air Fryer Lid in water or other liquid.
<p>Outer body</p>	<p>Clean with a barely-damp cloth and mild dish soap, then use a clean, barely-damp sponge to remove the soap residue. DO NOT machine wash.</p> <ul style="list-style-type: none"> • Wipe dry with a soft cloth. • DO NOT rinse or immerse the Air Fryer Lid in water or other liquid.
<p>Power cord</p>	<p>Wipe clean with a barely-damp cloth as needed.</p>

Some discoloration may occur after machine washing, but this will not affect the cooker's safety or performance.

Care, cleaning and storage

⚠ WARNING

To avoid risk of electrical shock and personal injury:

- Do not immerse the appliance in water or any liquid.
- Do not rinse the appliance under a tap.
- Do not wet the prongs of the power cord.

Without proper cleaning, food and grease splatter may build up around the heating element, causing the risk of smoke, fire, and personal injury.

If you smell or see black smoke, press **Cancel** and unplug the appliance. Once cool, clean food splatter or grease as directed on the previous page.

Storing the Air Fryer Lid

The protective pad and storage cover does double duty protecting your counters from the heat of the Air Fryer Lid, and protecting the heating element and cover while it's not in use!

- 01** Flip the protective pad over so the grooved side faces up.
- 02** Lower the Air Fryer Lid onto the protective pad as indicated in the image on the right.
- 03** Turn the Air Fryer Lid clockwise until the protective pad locks into place.

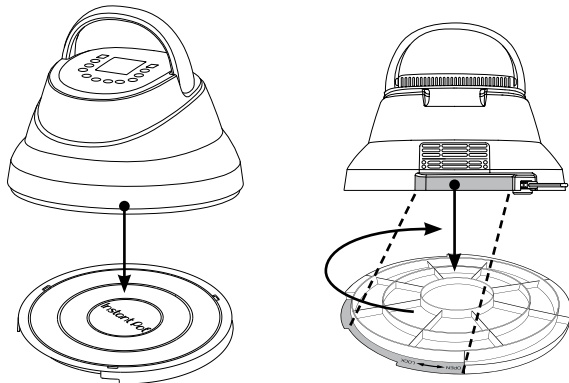

Troubleshooting

Register your product today.

If your problem persists or you have questions, get in touch with a Customer Care Advisor through our chat widget at instantpot.com/#chat, by email at support@instantpot.com or by phone at **1-800-828-7280**.

Problem	Possible Reason	Solution
Air Fryer Lid is plugged in but will not turn on, or turns off during cooking	The appliance is not plugged in.	Plug the power cord firmly into a grounded 120 V outlet.
	Bad power connection or no power.	Inspect power cord for damage. If damage is noticed, contact Customer Care . Check the outlet to ensure it is powered.
	Electrical fuse has blown.	Contact Customer Care .
	Microswitch is damaged.	Contact Customer Care .
Black smoke is coming from the Air Fryer Lid	⚠ CAUTION Stop cooking immediately. Press Cancel , then unplug the appliance. When smoking stops, place the Air Fryer Lid on the protective pad provided.	
	Food residue on the heating coil, in the cooking chamber or on the accessories.	Allow the Air Fryer Lid to cool to room temperature before cleaning. Remove food and accessories, then clean the affected area thoroughly.
	Using an oil with a low smoke point.	Choose a neutral oil with a high smoke point, such as canola, avocado, soybean, safflower or rice bran.
	Faulty circuit or heating element.	Contact Customer Care .
White smoke is coming from the Air Fryer Lid	Cooking foods with a high fat content, such as bacon, sausage and burgers, may result in white smoke.	Avoid air frying foods with a high fat content.
	Water is vaporizing, producing thick steam.	Pat dry moist food ingredients before air frying. Do not add water or other liquid to the inner pot when air frying.
	Seasoning on food has blown into element.	Be mindful when seasoning food. Spray vegetables and meats before adding seasoning so it better adheres to the ingredients
Error code flashes on display	Lid	Lid is not detected. Place the lid correctly on a compatible Instant Pot cooker base. Make sure the Instant Pot cooker base is unplugged.
	Pot	Inner Pot is not detected. Insert the inner pot into a compatible Instant Pot cooker base. Make sure the Instant Pot cooker base is unplugged.
	Food Burn	High heat detected in the inner pot. Deglaze the bottom of the inner pot as described in your Instant Pot user manual.

Any other servicing should be performed by an authorized service representative.

Warranty

Limited Warranty

This Limited Warranty is effective for one year from the date of original consumer purchase. Proof of original purchase date and, if requested by an authorized representative of Instant Brands Inc. ("Instant Brands"), return of your appliance, is required to obtain service under this Limited Warranty. Provided that this appliance is operated and maintained in accordance with written instructions attached to or furnished with the appliance, Instant Brands will, in its sole and exclusive discretion, either: (i) repair defects in materials or workmanship; or (ii) replace the appliance. In the event that your appliance is replaced, the Limited Warranty on the replacement appliance will expire 12 months from the date of original consumer purchase.

This Limited Warranty extends only to the original purchaser and use of the appliance in the United States of America and Canada. This warranty does not cover units that are used outside of the United States of America and Canada.

Any modification or attempted modification to your appliance may interfere with the safe operation of the appliance and will void this Limited Warranty. This Limited Warranty does not apply in respect of any appliance or any part thereof that has been altered or modified unless such alterations or modifications were expressly authorized by an Instant Brands representative.

Limitation and Exclusions

The liability of Instant Brands, if any, for any allegedly defective appliance or part shall in no circumstances exceed the purchase price of a comparable replacement appliance.

This Limited Warranty does not cover:

1. Damage resulting from accident, alteration, misuse, abuse, neglect, unreasonable use, use contrary to the operating instructions, normal wear and tear, commercial use, improper assembly, disassembly, failure to provide reasonable and necessary maintenance, fire, flood, acts of God or repair by anyone unless directed by an Instant Brands Representative;
2. Repairs where your appliance is used for other than normal, personal use or when it is used in a manner that is contrary to published user or operator instructions; or
3. Use of unauthorized parts and accessories, or repairs to parts and systems resulting from unauthorized repairs or modifications made to this appliance.

The cost of repair or replacement under these excluded circumstances shall be paid by you.

Warranty

Disclaimer of Implied Warranties

EXCEPT AS EXPRESSLY PROVIDED HEREIN AND TO THE EXTENT PERMITTED BY LAW, INSTANT BRANDS MAKES NO WARRANTIES, CONDITIONS OR REPRESENTATIONS, EXPRESS OR IMPLIED, BY STATUTE, USAGE, CUSTOM OR TRADE OR OTHERWISE WITH RESPECT TO THE APPLIANCES OR PARTS COVERED BY THIS WARRANTY, INCLUDING BUT NOT LIMITED TO, WARRANTIES, CONDITIONS, OR REPRESENTATIONS OF WORKMANSHIP, MERCHANTABILITY, MERCHANTABILITY, FITNESS FOR A PARTICULAR PURPOSE OR DURABILITY.

Some states or provinces do not allow for the exclusion of implied warranties of merchantability or fitness, so this limitation may not apply to you. In these states and provinces, you have only the implied warranties that are expressly required to be provided in accordance with applicable law.

Limitation of Remedies; Exclusion of Incidental and Consequential Damage

YOUR SOLE AND EXCLUSIVE REMEDY UNDER THIS LIMITED WARRANTY SHALL BE APPLIANCE REPAIR OR REPLACEMENT AS PROVIDED HEREIN. INSTANT BRANDS SHALL NOT BE LIABLE FOR INDIRECT, INCIDENTAL OR CONSEQUENTIAL DAMAGES ARISING OUT OF OR IN CONNECTION WITH THE USE OR PERFORMANCE OF THE APPLIANCE OR DAMAGES WITH RESPECT TO ANY ECONOMIC LOSS, PERSONAL INJURY, LOSS OF PROPERTY, LOSS OF REVENUES OR PROFITS, LOSS OF ENJOYMENT OR USE, COSTS OF REMOVAL, INSTALLATION OR OTHER INDIRECT, INCIDENTAL OR CONSEQUENTIAL DAMAGES OF ANY NATURE OR KIND.

Warranty Registration

Please visit www.instantpot.com/support/register to register your new Instant Brands™ appliance and validate your warranty within thirty (30) days of purchase. You will be asked to provide the store name, date of purchase, model number (found on the back of your appliance) and serial number (found on the bottom of your appliance) along with your name and email address. The registration will enable us to keep you up to date with product developments, recipes and contact you in the unlikely event of a product safety notification. By registering, you acknowledge that you have read and understand the instructions for use, and warnings set forth in the accompanying instructions.

Warranty Service

To obtain service under this warranty, please contact our Customer Service Department by phone at 1-800-828-7280 or by email to support@instantpot.com. You can also create a support ticket online at www.instantpot.com/support. If we are unable to resolve the problem, you may be asked to send your appliance to the Service Department for quality inspection. Instant Brands is not responsible for shipping costs related to warranty service, save and except for shipping costs associated with the return of your appliance from Canada or within the 48 contiguous states and the District of Columbia of the United States of America, as provided herein. When returning your appliance, please include your name, mailing address, email address, phone number, and proof of the original purchase date as well as a description of the problem you are encountering with the appliance.



Instant Brands Inc.

11–300 Earl Grey Dr., Suite 383
Ottawa, Ontario
K2T 1C1
Canada

Register your product today

instantpot.com/support/register

Contact us

1-800-828-7280
support@instantpot.com
instantpot.com/#Chat

instantpot.com
store.instantpot.com