

SAMSUNG

User Manual

S27R75* S32R75*

The color and the appearance may differ depending on the product, and the specifications are subject to change without prior notice to improve the performance.

The contents of this manual are subject to change without notice to improve quality.

© Samsung Electronics

Samsung Electronics owns the copyright for this manual.

Use or reproduction of this manual in parts or entirety without the authorization of Samsung Electronics is prohibited.

Trademarks other than that of Samsung Electronics are owned by their respective owners.

Table of contents

Before Using the Product

Securing the Installation Space	4
Safety Precautions	4
Cleaning	5
Electricity and Safety	5
Installation	6
Operation	7

Preparations

Parts	10
Control Panel	10
Direct Key Guide	11
Function Key Guide	12
Configuring Eye Saver Mode, Brightness and Contrast from Direct Key Guide	13
Types of Ports	14
Upgrading the Software via USB	15
Adjusting the Product Tilt and Height	17
Precautions for moving the product	18
Precautions for installation and use	19
Installing the stand on a table	20
Installation	21
Attaching the Stand	21
Removing the Stand	22
Tidying Up the Connected Cables	23

Connecting and Using a Source Device

Read below before installing the product.	24
Connecting and Using a PC	24
Connection Using the HDMI Cable	24
Connection Using the MINI DP Cable	25
Connecting the Power	25
Correct posture to use the product	26
Driver Installation	26
Setting Optimum Resolution	26

Screen Setup

SAMSUNG MAGIC Bright	27
Brightness	28
Contrast	28
Sharpness	28
Color	28
SAMSUNG MAGIC Upscale	29
HDMI Black Level	29
Eye Saver Mode	29
Game Mode	29
Response Time	29
Picture Size	30

Screen Adjustment	30
-------------------	----

Configuring the PIP/PBP Settings

PIP/PBP Mode	31
Size	32
Position	32
Picture Size	32
Contrast	33

Adjusting OSD (On Screen Display) settings

Transparency	34
Position	34
H-Position	34
V-Position	34
Language	34
Display Time	34

Table of contents

Setup and Reset

Self Diagnosis	35
DisplayPort Ver.	37
HDMI Mode	37
Eco Saving Plus	37
Off Timer Plus	38
PC/AV Mode	38
Source Detection	38
Key Repeat Time	39
Power LED On	39
Reset All	39

Information

Information	40
-------------	----

Installing the Software

Easy Setting Box	41
Restrictions and Problems with the Installation	41
Upgrade by downloading the firmware from the website	41
System Requirements	41

Troubleshooting Guide

Requirements Before Contacting Samsung Customer Service Center	42
Product diagnosis (Screen issue)	42
Checking the Resolution and Frequency	42
Check the following.	42
Q & A	44

Specifications

General	45
Standard Signal Mode Table	46

Appendix

Responsibility for the Pay Service (Cost to Customers)	51
Not a product defect	51
A Product damage caused by customer's fault	51
Others	51

Chapter 01

Before Using the Product

Securing the Installation Space

Make sure to have enough space for ventilation when placing the product. An internal temperature rise may cause fire and damage the product. Maintain enough space around the product as shown in the diagram when installing the product.

— The exterior may differ depending on the product.

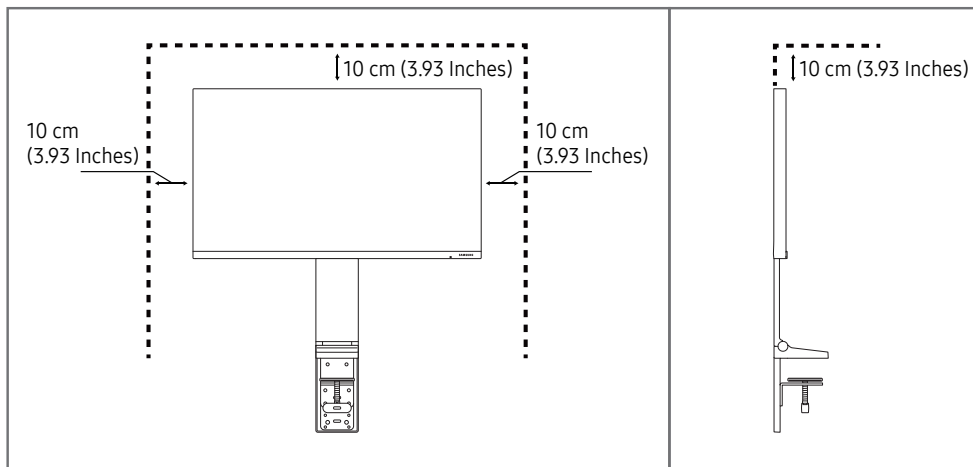

Safety Precautions

Warning

A serious or fatal injury may result if instructions are not followed.

Caution

Personal injury or damage to properties may result if instructions are not followed.

CAUTION

RISK OF ELECTRIC SHOCK. DO NOT OPEN.

CAUTION: TO REDUCE THE RISK OF ELECTRIC SHOCK, DO NOT REMOVE COVER (OR BACK). THERE ARE NO USER SERVICEABLE PARTS INSIDE. REFER ALL SERVICING TO QUALIFIED PERSONNEL.

	This symbol indicates that high voltage is present inside. It is dangerous to make any kind of contact with any internal part of this product.		AC voltage: Rated voltage marked with this symbol is AC voltage.
	This symbol indicates that this product has included important literature concerning operation and maintenance.		DC voltage: Rated voltage marked with this symbol is DC voltage.
	Class II product: This symbol indicates that a safety connection to electrical earth (ground) is not required. If this symbol is not present on a product with a mains lead, the product MUST have a reliable connection to protective earth (ground).		Caution. Consult instructions for use: This symbol instructs the user to consult the user manual for further safety related information.

Cleaning

High-glossy models can develop white stains on the surface if an ultrasonic wave humidifier is used nearby.

— Contact your nearest Samsung Customer Service Center if you want to clean the inside of the product (Service fee will be charged.)

Do not press the product screen with hands or other objects. There is a risk of damaging the screen.

— Exercise care when cleaning as the panel and exterior of advanced LCDs are easily scratched.

— Take the following steps when cleaning.

- 1 Power off the product and PC.
- 2 Disconnect the power cord from the product.
 - Hold the power cable by the plug and do not touch the cable with wet hands. Otherwise, an electric shock may result.
- 3 Wipe the product with a clean, soft and dry cloth.
 - Do not apply a cleaning agent that contains alcohol, solvent, or surfactant to the product.
 - Do not spray water or detergent directly on the product.
- 4 Wet a soft cloth in water, wring it out well, and then use the cloth to wipe the exterior of the product clean.
- 5 Connect the power cord to the product when cleaning is finished.
- 6 Power on the product and PC.

Electricity and Safety

Warning

- Do not use a damaged power cord or plug, or a loose power socket.
- Do not use multiple products with a single power socket.
- Do not touch the power plug with wet hands.
- Insert the power plug all the way in so it is not loose.
- Connect the power plug to a grounded power socket (type 1 insulated devices only).
- Do not bend or pull the power cord with force. Be careful not to leave the power cord under a heavy object.
- Do not place the power cord or product near heat sources.
- Clean any dust around the pins of the power plug or the power socket with a dry cloth.

Caution

- Do not disconnect the power cord while the product is being used.
- Only use the power cord provided with your product by Samsung. Do not use the power cord with other products.
- Keep the power socket where the power cord is connected unobstructed.
 - The power cord must be disconnected to cut off power to the product when an issue occurs.
- Hold the plug when disconnecting the power cord from the power socket.

Installation

Warning

- DO NOT PLACE CANDLES, INSECT REPELLANTS OR CIGARETTES ON TOP OF THE PRODUCT. DO NOT INSTALL THE PRODUCT NEAR HEAT SOURCES.
- Keep the plastic packaging out of the reach of children.
 - Children may suffocate.
- Do not install the product on an unstable or vibrating surface (insecure shelf, sloped surface, etc.)
 - The product may fall and become damaged and/or cause an injury.
 - Using the product in an area with excess vibration may damage the product or cause a fire.
- Do not install the product in a vehicle or a place exposed to dust, moisture (water drips, etc.), oil, or smoke.
- Do not expose the product to direct sunlight, heat, or a hot object such as a stove.
 - The product lifespan may be reduced or a fire may result.
- Do not install the product within the reach of young children.
 - The product may fall and injure children.
- Edible oil (such as soybean oil) may damage or distort the product. Keep the product away from oil pollution. And do not install or use the product in the kitchen or near the kitchen stove.

Caution

- Do not drop the product while moving.
- Do not set down the product on its front.
- When installing the product on a cabinet or shelf, make sure that the bottom edge of the front of the product is not protruding.
 - The product may fall and become damaged and/or cause an injury.
 - Install the product only on cabinets or shelves of the right size.
- Set down the product gently.
 - Product failure or personal injury may result.
- Installing the product in an unusual place (a place exposed to a lot of fine dust, chemical substances, extreme temperatures or a significant presence of moisture, or a place where the product will operate continuously for an extended period of time) may seriously affect its performance.
 - Be sure to consult Samsung Customer Service Center if you want to install the product at such a place.

Operation

Warning

- There is a high voltage inside the product. Never disassemble, repair or modify the product yourself.
 - Contact Samsung Customer Service Center for repairs.
- To move the product, first disconnect all the cables from it, including the power cable.
- If the product generates abnormal sounds, a burning smell or smoke, disconnect the power cord immediately and contact Samsung Customer Service Center.
- Do not let children hang from the product or climb on top of it.
 - Children may become injured or seriously harmed.
- If the product is dropped or the outer case is damaged, turn off the power and disconnect the power cord. Then contact Samsung Customer Service Center.
 - Continued use can result in a fire or electric shock.
- Do not leave heavy objects or items that children like (toys, sweets, etc.) on top of the product.
 - The product or heavy objects may fall as children try to reach for the toys or sweets resulting in a serious injury.
- During a lightning or thunderstorm, power off the product and remove the power cable.
- Do not drop objects on the product or apply impact.
- Do not move the product by pulling the power cord or any cable.
- If a gas leakage is found, do not touch the product or power plug. Also, ventilate the area immediately.
- Do not lift or move the product by pulling the power cord or any cable.
- Do not use or keep combustible spray or an inflammable substance near the product.
- Ensure the vents are not blocked by tablecloths or curtains.
 - An increased internal temperature may cause a fire.
- Do not insert metallic objects (chopsticks, coins, hairpins, etc) or objects that burn easily (paper, matches, etc) into the product (via the vent or input/output ports, etc).
 - Be sure to power off the product and disconnect the power cord when water or other foreign substances have entered the product. Then contact Samsung Customer Service Center.
- Do not place objects containing liquid (vases, pots, bottles, etc) or metallic objects on top of the product.
 - Be sure to power off the product and disconnect the power cord when water or other foreign substances have entered the product. Then contact Samsung Customer Service Center.

Caution

- Leaving the screen fixed on a stationary image for an extended period of time may cause afterimage burn-in or defective pixels.
 - Set the screen to power-saving mode or moving-picture screen saver when not using the product for an extended period of time.
- Disconnect the power cord from the power socket if you do not plan on using the product for an extended period of time (vacation, etc).
 - Dust accumulation combined with heat can cause a fire, electric shock or electric leakage.
- Use the product at the recommended resolution and frequency.
 - Your eyesight may deteriorate.
- Do not put AC/DC adapters together.
- Remove the plastic bag from the AC/DC adapter before you use it.
- Do not let water enter the AC/DC adapter device or get the device wet.
 - An electric shock or fire may result.
 - Avoid using the product outdoors where it can be exposed to rain or snow.
 - Be careful not to get the AC/DC adapter wet when you wash the floor.
- Do not put the AC/DC adapter near to any heating apparatus.
 - Otherwise, a fire may result.
- Keep the AC/DC adapter in a well-ventilated area.
- If you place the AC/DC power adapter hanging with the cord input facing upwards, water or other foreign substances could enter the Adapter and cause the Adapter to malfunction.
Make sure to rest the AC/DC power adapter flat on a table or the floor.
- Insert the power plug into the AC/DC adapter until a click sound is heard.
- Do not insert only the power plug into the power outlet.
- Do not use an AC/DC adapter other than the provided one.
 - It may cause electric shock or fire.
- Do not insert the AC/DC adapter into the power outlet on the ceiling.
 - It may cause electric shock or fire.
- Rotate the power plug not to exceed the range (0 to 90°) on the AC/DC adapter.
 - It may cause electric shock or fire.
- Never disassemble the power plug after being assembled. (It cannot be separated after assembly.)
- Never use the provided power plug for other devices.
- When removing the AC/DC adapter from the power outlet, hold the body of AC/DC adapter and pull it up.
 - It may cause electric shock or fire.
- Do not drop any objects or apply shock on the AC/DC adapter.
 - It may cause electric shock or fire.
- Use the AC/DC adapter after removing its plastic cover.
 - Otherwise, this may result fire.

-
- Do not hold the product upside-down or move it by holding the stand.
 - The product may fall and become damaged or cause an injury.
 - Looking at the screen too close for an extended period of time can deteriorate your eyesight.
 - Do not use humidifiers or stoves around the product.
 - Rest your eyes for more than 5 minutes or look at distance objects for every 1 hour of product use.
 - Do not touch the screen when the product has been turned on for an extended period of time as it will become hot.
 - Store small accessories out of the reach of children.
 - Exercise caution when adjusting the product angle or stand height.
 - Your hand or finger may get stuck and injured.
 - Tilting the product at an excessive angle may cause the product to fall and an injury may result.
 - Do not place heavy objects on the product.
 - Product failure or personal injury may result.

Chapter 02

Preparations

Parts

Control Panel

The color and shape of parts may differ from what is shown. Specifications are subject to change without notice to improve quality.

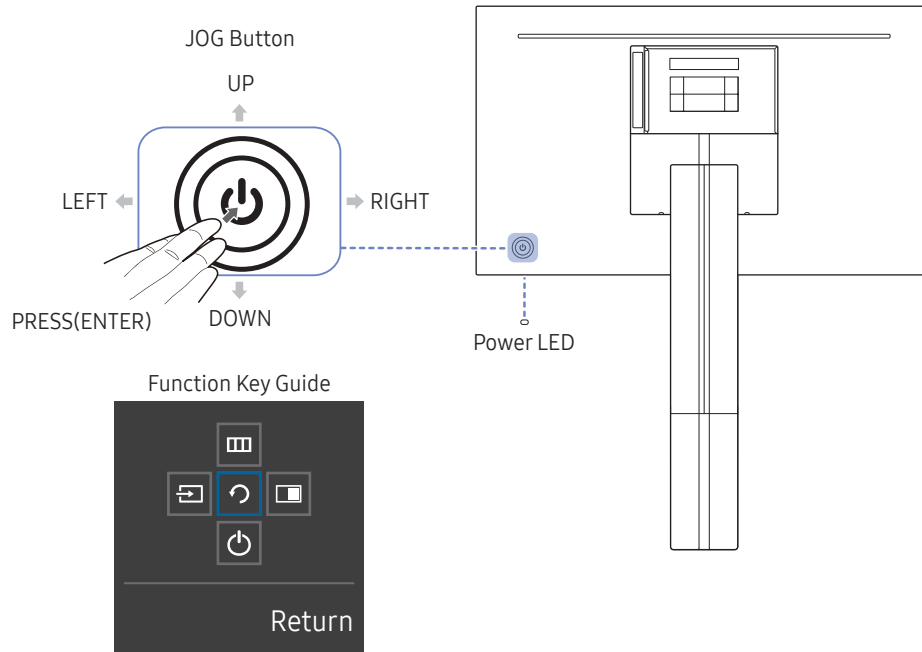

Parts	Description
JOG Button	Multi directional button that helps navigate. The JOG button is located on the rear left side of the product. The button can be used to move up, down, left or right, or as Enter.
Power LED	This LED is power status indicator and works as <ul style="list-style-type: none">Power On (Power button): Power LED OffPower saving mode: Power LED BlinkingPower Off (Power button): Power LED On The Power LED operation can be swapped by changing in the menu. (System → Power LED On) Actual models because of functional variation maybe haven't this function. The power button is located on the left of the rear and used to turn on or off the product.
Function Key Guide	Press the JOG button when the screen is turned on. The Function Key Guide will appear. To access the onscreen menu when the guide is displayed, press the corresponding direction button again. Function Key Guide may vary depending on the function or product model. Please refer to the actual product.

Direct Key Guide

— On the Direct Key Guide screen, the following menu options appear when the product screen is switched on or the input source is changed.

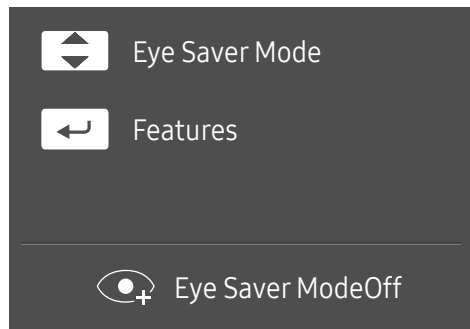

- UP/DOWN: Adjust **Brightness, Contrast, Eye Saver Mode**.
- PRESS(ENTER): Display Function Key Guide.





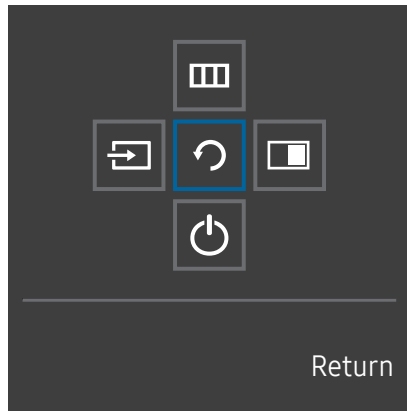





Function Key Guide

— To use the Function Key Guide, press the JOG button. Then the following window appears.



UP/DOWN/LEFT/RIGHT: Move to the item you want. The description for each item will appear when the focus changes.

PRESS(ENTER): The selected item will be applied.

Parts	Description
Source	 <p>Selects  to change the input source by moving the JOG button in the Function Key Guide screen. A message will appear on the top left corner of the screen if the input source has been changed.</p>
Menu	 <p>Selects  by moving the JOG button in the Function Key Guide screen. This product shows the menu as an on-screen display. On screen display menu lock: Lock the on screen display menu to maintain the current settings or prevent other users from changing settings. Enable/Disable: To enable or disable the on screen display menu lock, display the “Menu” screen, move the jog button to the right to go to the next stage, and then press and hold the button to the left for 10 seconds. — If the on screen display menu lock is enabled, Brightness and Contrast can be adjusted. The PIP/PBP function can also be used. Eye Saver Mode is available. Information can be viewed.</p>
PIP/PBP	 <p>Selects  by moving the JOG button in the Function Key Guide screen. And then press the JOG button when configuring settings for the PIP/PBP function is required.</p>
Power Off	 <p>Selects  to turn the product off by moving the JOG button in the Function Key Guide screen.</p>
Return	 <p>Return to the previous menu by using the JOG button to select the  icon when the Function Key Guide screen is displayed.</p>

— Actual models because of functional variation, Function Key Guide options will be different.

When the product displays nothing (i.e. Power saving mode or Non-signal mode), 2 direct keys for control source and power could be used as below.

JOG Button	Power saving/Non-signal mode
UP	Source Change
Down	
PRESS(ENTER) for 2 seconds	Power Off

When the product displays the menu the JOG Button could be used as below.

JOG Button	Action
UP/DOWN	Move the option
	Exit the menu.
LEFT	Close Sublist without saving value. Value decreases in the slider.
RIGHT	Move to sublist. Value increases in the slider.
PRESS(ENTER)	Save the value and close Sublist.

Configuring Eye Saver Mode, Brightness and Contrast from Direct Key Guide

Adjust the **Brightness**, **Contrast** and **Eye Saver Mode** by moving the JOG button.



— The displayed image may differ depending on the model.

Brightness

- This menu is not available when **SAMSUNG MAGICBright** is set to **Dynamic Contrast** mode.
- This menu is not available when **Eco Saving Plus** is enabled.
- This menu is not available when **Eye Saver Mode** is enabled.





Contrast

- This menu is not available when **SAMSUNG MAGICBright** is in **Cinema** or **Dynamic Contrast** mode.
- This menu is not available when **Game Mode** is enabled.
- This menu is not available when **PIP/PBP Mode** is set to **On** and the **Size** is set to  (PBP Mode).

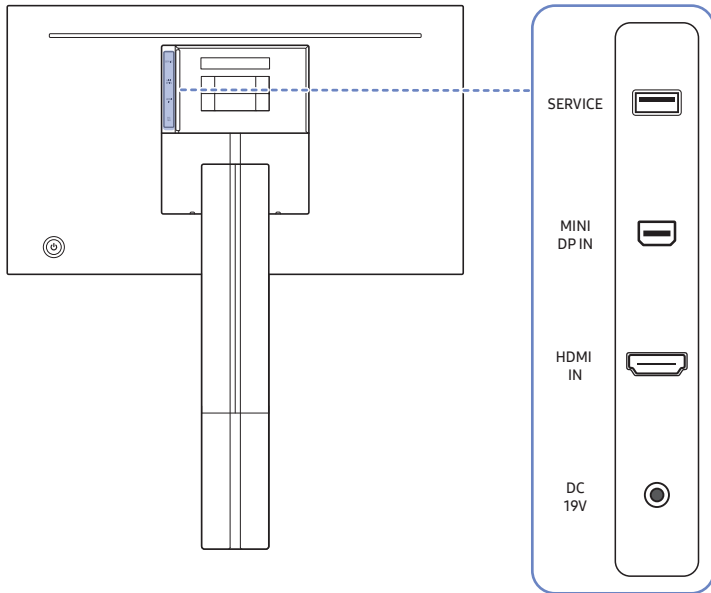
Types of Ports

— The functions available may vary depending on the product model. The color and shape of parts may differ from what is shown. Specifications are subject to change without notice to improve quality. Refer to the actual product.



Port		Description
SERVICE		Use a USB memory stick to perform software upgrade.
MINI DP IN		Connects to a PC using a MINI DP cable. — S27R75*: MINI DP IN support 2560 x 1440 @ 144 Hz — S32R75*: MINI DP IN support 3840 x 2160 @ 60 Hz
HDMI IN		Connects to a source device using an HDMI cable. — S27R75*: HDMI IN support 2560 x 1440 @ 144 Hz — S32R75*: HDMI IN support 3840 x 2160 @ 60 Hz
DC 19V		Connects to the AC/DC adapter.

Upgrading the Software via USB

- 1 Connect a USB memory to the SERVICE port shown in the figure.

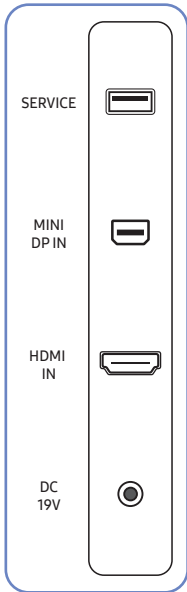

When the screen is on, press the jog button to display the Function Key Guide. When the Function Key Guide are displayed, press and hold the jog button down for approximately 5 seconds.

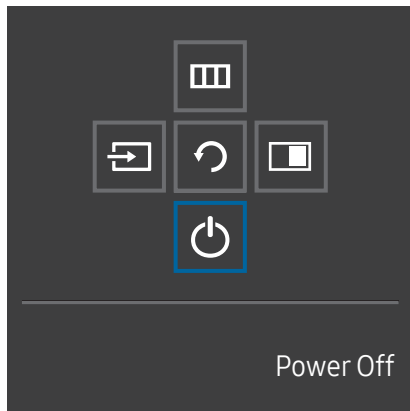

- 2 When the message as shown in the following figure is displayed on the product, select **Yes** to upgrade the software.

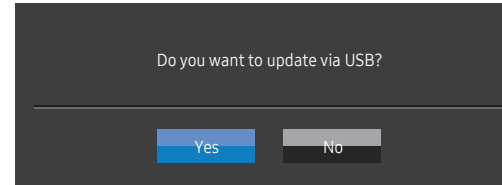

- 3 When the screen as shown in the following figure is displayed, select **Yes**.

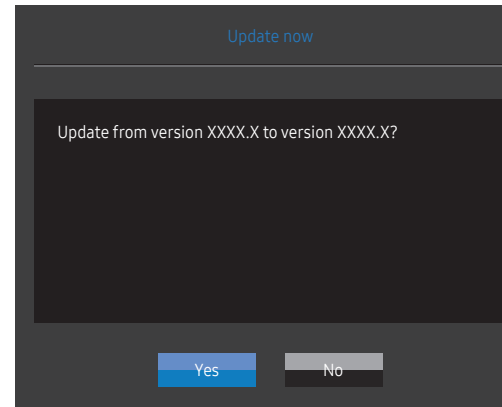

- 4 The software upgrading proceeds.

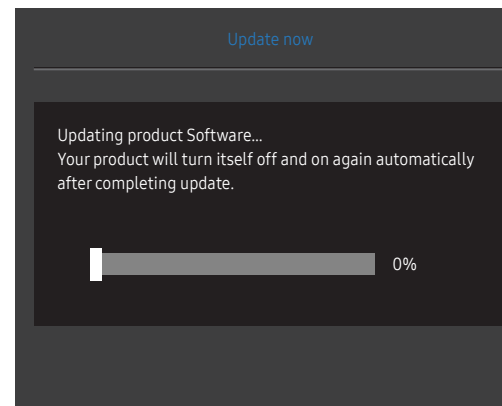

Note

- 1 To perform software upgrade by using a USB memory, first format the USB memory to FAT32.
- 2 When performing upgrade, make sure that only one BIN file (.bin) is saved in the root directory.
- 3 To upgrade the software for the SR75 model, make sure the upgrade files are .bin formats. The file name should follow the naming conventions for the SR75 model (e.g. M-R75**SGAA-****.*[four-digit number].bin). The ** is the screen size in inches, the ****.* is the version number, and the four-digit number is the checksum. For example, "M-R7532SGAA-0800.0[D06E].bin" conforms to the naming conventions for the SR75 32" model and should be copied to the root directory.
- 4 If the **No valid update files found. Please check your USB device and try again.** message is displayed, this is probably due to the following reasons.

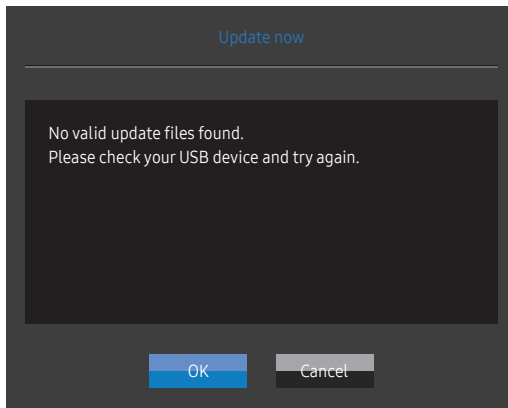

- A USB memory is not connected to the SERVICE port.
 - The files in the connected USB memory are not compatible formats.
 - There are no valid upgrade files found in the connected USB memory. (There are no upgrade files saved in the memory or the file names are incorrect.)
- 5 Do not turn off the product. And prevent the upgrading from any interruption as far as possible. In general, the product returns to the previous version if an upgrade is interrupted.

Adjusting the Product Tilt and Height

— The color and shape of parts may differ from what is shown. Specifications are subject to change without notice to improve quality.

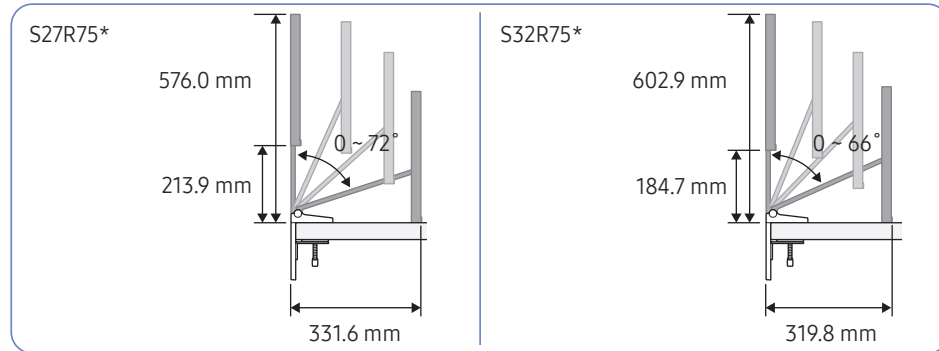

Adequate operation range

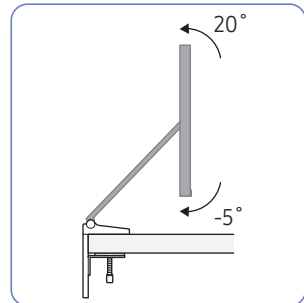

When touched to the floor

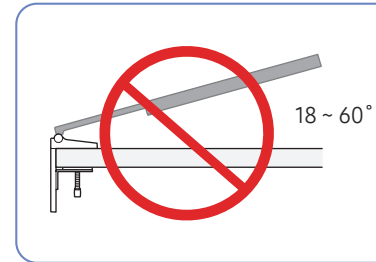
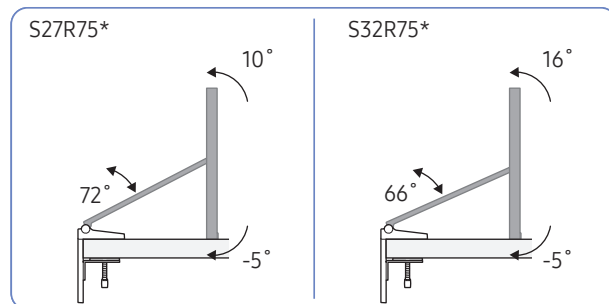

Do not use or store the product with the screen facing down.

- It is recommended that the product be tilted to an angle within the optimum range.
- When installing the product close to a wall with excessive force, exercise caution so that your hand is not caught between the product and the wall.
- The rotation and height adjustment has a certain tolerance. Stay within the tolerances when rotating or adjusting the height of the product.
- Hold the sides of the product when adjusting the height.

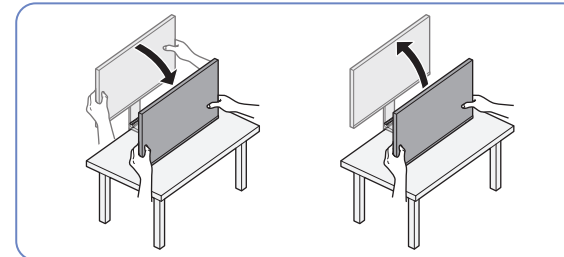

— Be careful not to apply excessive force to the screen when adjusting the product height.

Precautions for moving the product

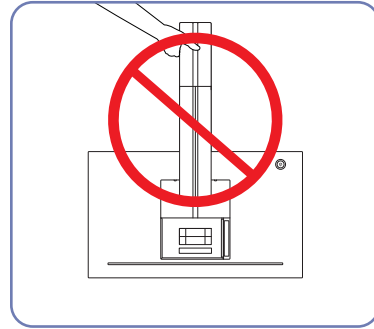
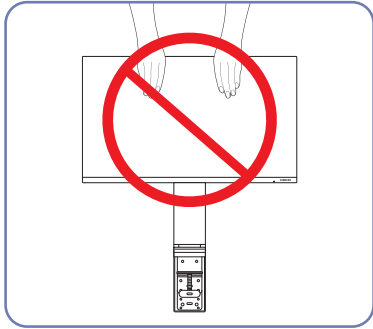

- Do not directly apply pressure on the screen.
- Do not hold the screen when moving the product.
- Do not hold the product upside down only by the stand.

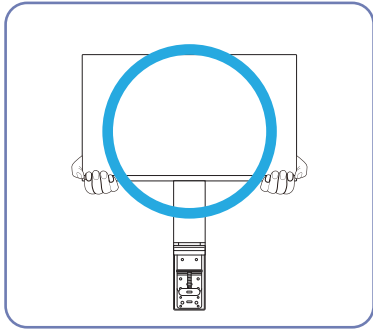

- Hold the lower corners or edges of the product when moving it.

Precautions for installation and use

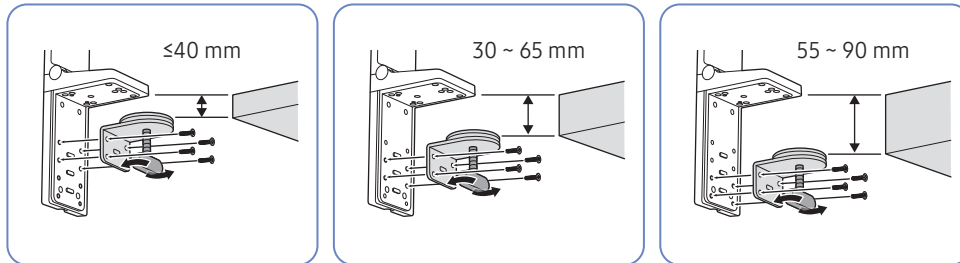

- Table thickness for installation: ≤ 40 mm, 30 ~ 65 mm, 55 ~ 90 mm
- To install the product on a table, make sure the table is strong enough to bear the product weight. Installing the product on a table made of glass or other fragile material may damage the product.
- It is difficult to install the product on a table that has a raised edge. Exercise caution during installation.
- If the table top surface is uneven or inclined, the product may not be able to stand properly.
- Installing the stand may cause an imprint of the stand to form on the table.

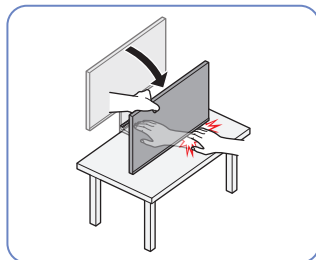

- When lowering the product close to the floor, make sure you hold the sides of the product. Do not lower the product with excessive force. There is a risk of damage to your hands.

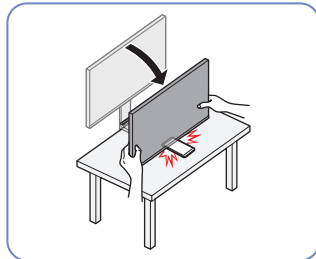

- Do not put any object under the product. There is a risk of damage to the object when lowering the product close to the floor.

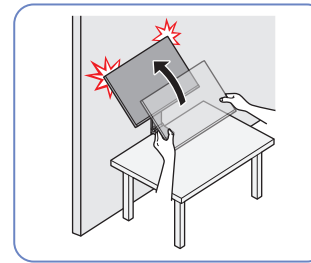

- If the product is set up close to a wall and you tilt the stand to raise it up, the product may collide with the wall and become damaged. Do not raise the product with excessive force.

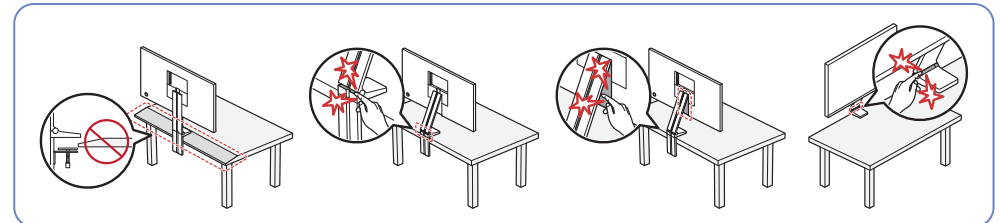

- Do not install the product on an angled part of the table.
- When adjusting the product height, do not put your hand near the region where the stand is folded.
- If you set the product to an incompatible resolution, screen flickering may occur. Change to a supported resolution by referring to the Standard Signal Mode Table.

Installing the stand on a table

Table requirements for installing the stand are shown below by table type.

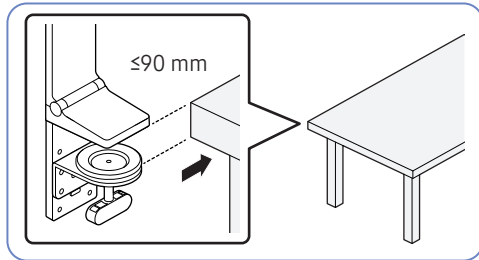

- Table with no raised edge
- The stand can be used through adjustment depending on the table thickness. (≤ 90 mm)

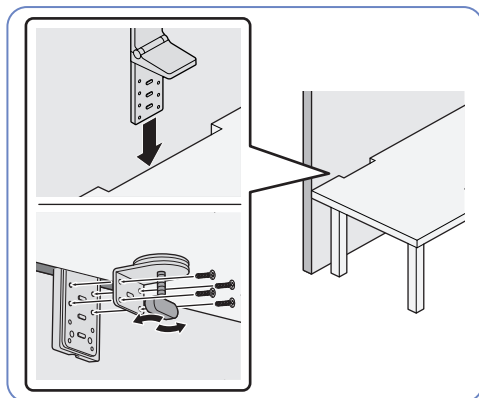
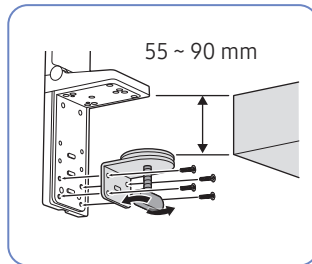
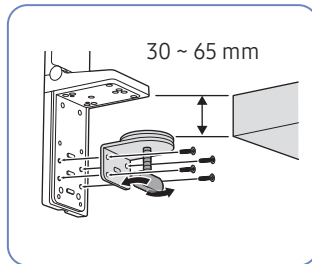
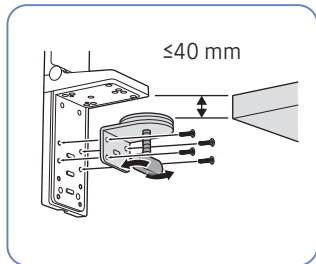

- Table with a spaced partition
- The stand can be installed if the gap between the table and the partition is more than 15 mm.
- Tidy up the cables by running them in the stand groove on the rear of the product before installing the stand on the table. It is difficult to tidy up cables if the gap between the table and the partition is narrow. For details on how to tidy up cables, refer to "[Tidying Up the Connected Cables.](#)"

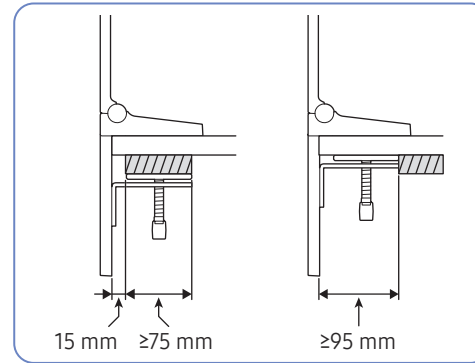

- Table with a raised edge (▨▨▨▨)
- The stand can be installed if a 90 mm space is available between the spot 15 mm away from one end of the table and the other end or if the distance to the raised edge is more than 95 mm.

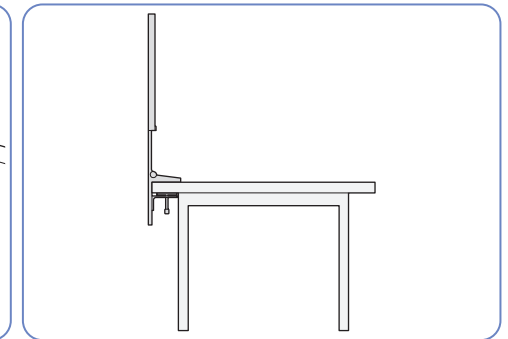
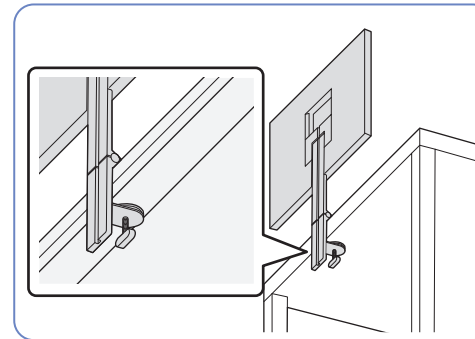

Installation

Attaching the Stand

- Before assembling the product, place the product down on a flat and stable surface so that the screen is facing downwards.
- The exterior may differ depending on the product.
- The table should be relocated, depending on the space where the stand will be installed.
- Attach the stand to the product and tidy up the cables.

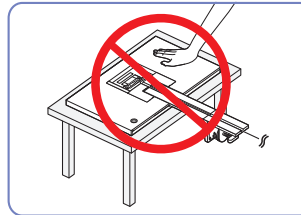

Caution

Do not press down on the product. There is a risk of damaging the product.

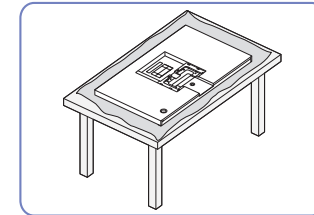

Before placing the product facing down to the table, put a cushion on the table to protect the product screen.

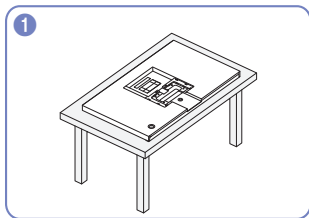

1 Make sure the product front faces down, as shown in the figure.

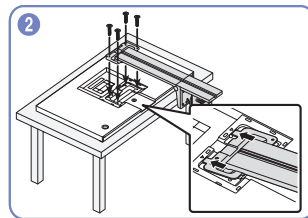

2 Attach and fix the stand to the rear of the product by using the screws.

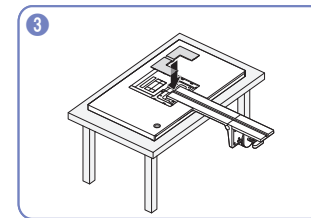

3 Attach the Cover-Clean Back Stand.

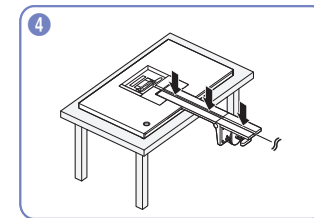

4 After attaching the stand to the product, tidy up the cables.

- For details on how to tidy up cables, refer to [“Tidying Up the Connected Cables.”](#)

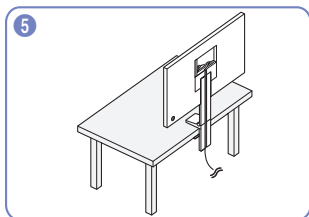

5 Install the stand on the table, as shown in the figure.

- Before installing the stand, adjust the handle to fit the table thickness for easier installation.

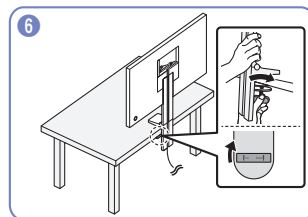

6 After installing the stand on the table, turn the clamp to the right to engage the lock.

- If you turn it to the left, the lock will be disengaged.

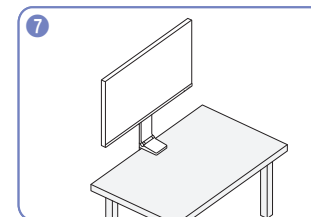

7 The stand is now completely assembled.

Removing the Stand

- Before removing the stand from the product, place the product on a flat and stable surface with the screen facing down.
- The exterior may differ depending on the product.
- The table should be relocated, depending on the space where the stand will be installed.

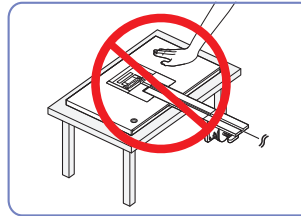

Caution

Do not press down on the product. There is a risk of damaging the product.

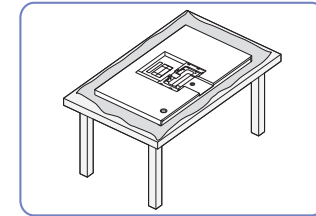

Before placing the product facing down to the table, put a cushion on the table to protect the product screen.

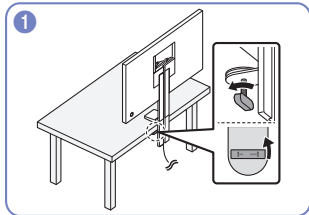

Turn the clamp on the stand, installed on the table, to the left to disengage the lock.

- If you turn it to the right, the lock will be engaged.

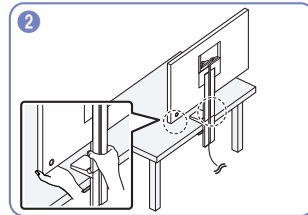

Remove the stand from the table by holding the stand and the bottom of the product.

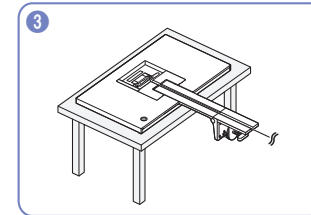

Make sure the product front faces down, as shown in the figure.

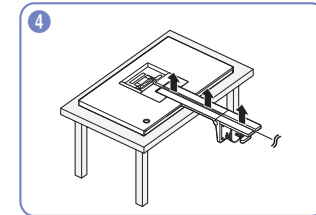

Remove the connected cables.

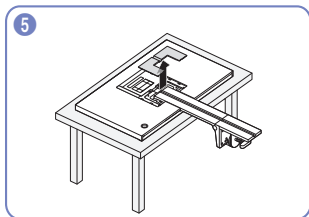

Remove the Cover-Clean Back Stand.

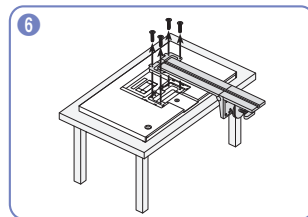

Remove the screws on the stand.

Tidying Up the Connected Cables

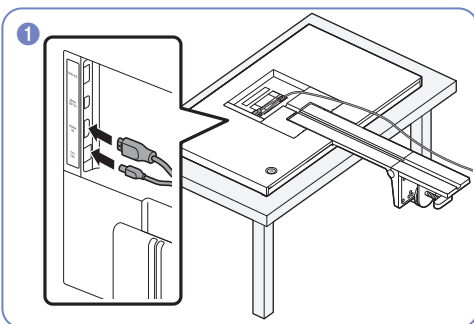

1 Connect the Y cables to the two ports, as shown in the figure.

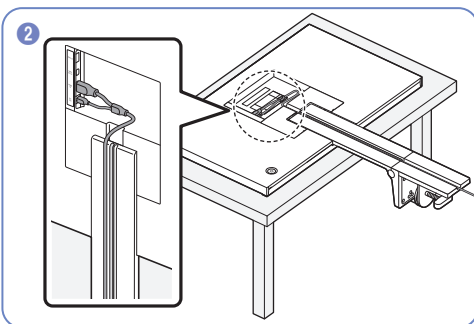

2 Tidy up the connected Y cable by aligning it with the stand groove, as shown in the figure.

- Make sure the Y cable is tidied up at the left of the groove.
- The MINI DP cable can be tidied up at the right side.

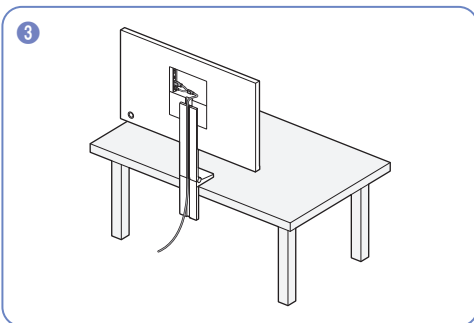

3 Use the same method to tidy up other cables.

Chapter 03

Connecting and Using a Source Device

Read below before installing the product.

- 1 Before installing the product, check the shapes of both ports of the supplied signal cables and the shapes and locations of the ports on the product and external device.
- 2 Before installing the product, make sure you remove the power cables from both the product and the external device to prevent damage to the product due to a short circuit or over current.
- 3 After all signal cables have been properly connected, connect the power cables back to the product and the external device.
- 4 After installation is completed, make sure you read the user guide to acquaint yourself with the product functions, precautions and other information required to use the product properly.

Connecting and Using a PC

Select a connection method suitable for your PC.

- Connecting parts may differ in different products.
- Provided ports may vary depending on the product.

Connection Using the HDMI Cable



First make sure that the power cables for product and other devices (e.g. PC, settop box, etc.) are removed.

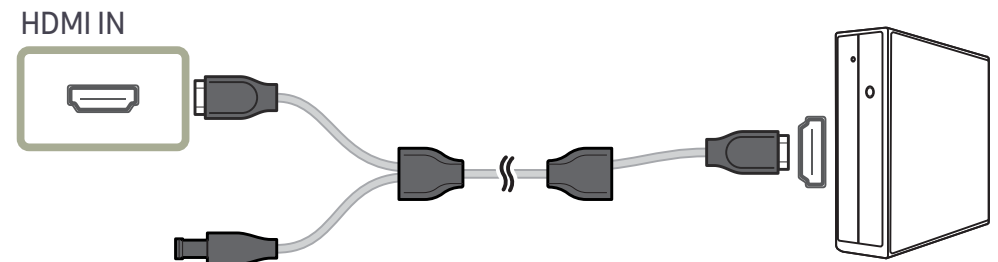

- S27R75*: To display 2560 x 1440 @ 144 Hz, use an HDMI cable that supports 2560 x 1440 @ 144 Hz to connect HDMI IN. Make sure that the graphics card of the HDMI source supports 2560 x 1440 @ 144 Hz.
- S32R75*: To display 3840 x 2160 @ 60 Hz, use an HDMI cable that supports 3840 x 2160 @ 60 Hz to connect HDMI IN. Make sure that the graphics card of the HDMI source supports 3840 x 2160 @ 60 Hz.
- When connecting an HDMI cable, use the cable that came with the components of the product. If you use an HDMI cable other than provided by Samsung, the image quality may be degraded.

Connection Using the MINI DP Cable

 First make sure that the power cables for product and other devices (e.g. PC, settop box, etc.) are removed.

MINI DP IN

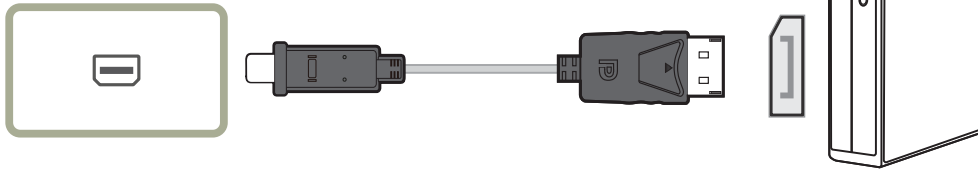

- S27R75*: To display 2560 x 1440 @ 144 Hz, use a MINI DP cable that supports 2560 x 1440 @ 144 Hz. Make sure that the graphics card of the MINI DP source supports 2560 x 1440 @ 144 Hz.
- S32R75*: To display 3840 x 2160 @ 60 Hz, use a MINI DP cable that supports 3840 x 2160 @ 60 Hz. Make sure that the graphics card of the MINI DP source supports 3840 x 2160 @ 60 Hz.

Connecting the Power

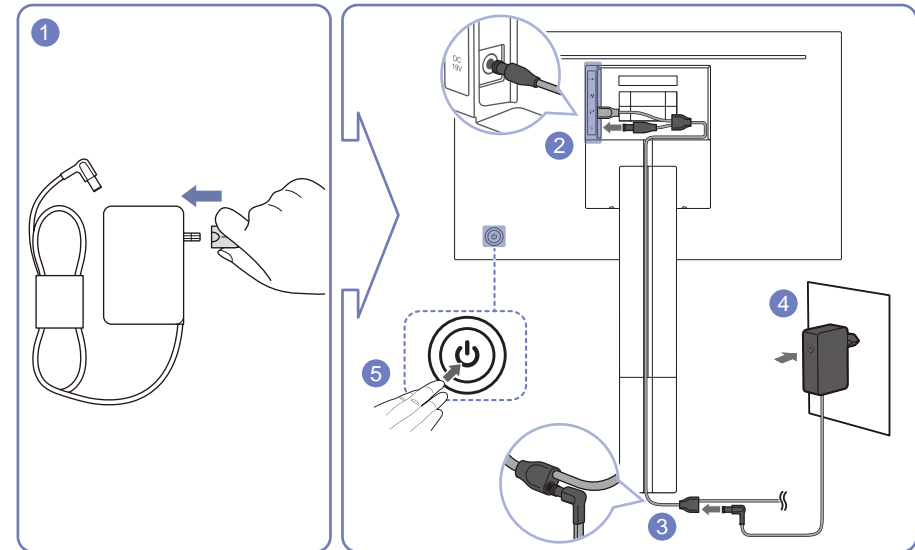

- 1 Connect the power plug to the AC/DC adapter.
Do not remove the power plug after assembly.
 - 2 Connect the power cable of the Y cable to the DC 19V port on the rear of the product.
 - 3 Connect the power cable of the power adapter, connected to the power plug, to the Y cable which has been tidied up.
 - 4 Plug the AC/DC adapter into the power outlet.
 - 5 Press the JOG button on the back of the product to turn it on.
- The input voltage is switched automatically.
 - In some areas, installation of an additional power plug is not necessary.

Correct posture to use the product



Use the product in the correct posture as follows:

- Straighten your back.
- Allow a distance of 45 to 50cm between your eye and the screen, and look slightly downward at the screen.
- Keep your eyes directly in front of the screen.
- Adjust the angle so light does not reflect on the screen.
- Keep your forearms perpendicular to your upper arms and level with the back of your hands.
- Keep your elbows at about a right angle.
- Adjust the height of the product so you can keep your knees bent at 90 degrees or more, your heels attached to the floor, and your arms lower than your heart.
- Do the Eye exercises or blink frequently, then eye fatigue will be relieved.

Driver Installation

- You can set the optimum resolution and frequency for this product by installing the corresponding drivers.
- To install the latest version of the product driver, download it from the Samsung Electronics website at <http://www.samsung.com>.

Setting Optimum Resolution

An information message about setting optimum resolution will appear if you power on the product for the first time after purchase.

Select a language on information message and change the resolution on your PC to the optimum setting.

- If the optimum resolution is not selected, the message will appear up to three times for a specified time even when the product is turned off and on again.
- If you want to set the optimum resolution for your computer. Please refer to (Q&A) → [“How can I change the resolution?”](#)

Chapter 04

Screen Setup

Function Key Guide →  → Picture

Configure the screen settings such as brightness. A detailed description of each function is provided. Refer to your product for details.

— The functions available may vary depending on the product model. The color and shape of parts may differ from what is shown. Specifications are subject to change without notice to improve quality.

SAMSUNG MAGIC Bright

This menu provides an optimum picture quality suitable for the environment where the product will be used.

- This menu is not available when **Eco Saving Plus** is enabled.
- This menu is not available when **Game Mode** is enabled.
- This menu is not available when **Eye Saver Mode** is enabled.
- Not available when **PIP/PBP Mode** is set to **On**.

In PC mode

- **Custom:** Customize the contrast and brightness as required.
- **Standard:** Obtain a picture quality suitable for editing documents or using Internet.
- **Cinema:** Obtain the brightness and sharpness of TVs suitable for enjoying video and DVD content.
- **Dynamic Contrast:** Obtain balanced brightness through automatic contrast adjustment.

In AV mode

When the external input is connected through HDMI/MINI DP and **PC/AV Mode** is set to **AV**, **SAMSUNG MAGIC Bright** has four automatic picture settings (**Dynamic**, **Standard**, **Movie** and **Custom**) that are preset at the factory. You can activate either **Dynamic**, **Standard**, **Movie** or **Custom**. You can select **Custom** which automatically recalls your personalized picture settings.

- **Dynamic:** Select this mode to view a sharper image than in **Standard** mode.
- **Standard:** Select this mode when the surroundings are bright.
- **Movie:** Select this mode when the surroundings are dark. This will save power and reduce eye fatigue.
- **Custom:** Select this mode when you want to adjust the image according to your preferences.

Brightness

You can adjust the general brightness of the picture. (Range: 0~100)

A higher value will make the picture appear brighter.

- This menu is not available when **SAMSUNG MAGICBright** is set to **Dynamic Contrast** mode.
- This menu is not available when **Eco Saving Plus** is enabled.
- This menu is not available when **Eye Saver Mode** is enabled.

Contrast

Adjust the contrast between the objects and background. (Range: 0~100)

A higher value will increase the contrast to make the object appear clearer.

- This option is not available when **SAMSUNG MAGICBright** is in **Cinema** or **Dynamic Contrast** mode.
- This menu is not available when **Game Mode** is enabled.
- This menu is not available when **PIP/PBP Mode** is set to **On** and the **Size** is set to  (PBP Mode).

Sharpness

Make the outline of objects more clear or blurry. (Range: 0~100)

A higher value will make the outline of objects clearer.

- This option is not available when **SAMSUNG MAGICBright** is in **Cinema** or **Dynamic Contrast** mode.
- This menu is not available when **Game Mode** is enabled.
- Not available when **PIP/PBP Mode** is set to **On**.

Color

Adjust the tint of the screen.

- This menu is not available when **SAMSUNG MAGICBright** is set to **Cinema** or **Dynamic Contrast** mode.
- This menu is not available when **Game Mode** is enabled.
- This menu is not available when **Eye Saver Mode** is enabled.
- Not available when **PIP/PBP Mode** is set to **On**.
- **Red**: Adjust the red saturation level. Values closer to 100 mean greater intensity for the color.
- **Green**: Adjust the green saturation level. Values closer to 100 mean greater intensity for the color.
- **Blue**: Adjust the blue saturation level. Values closer to 100 mean greater intensity for the color.
- **Color Tone**: Select a color tone that best suits your viewing needs.
 - **Cool 2**: Set the color temperature to be cooler than **Cool 1**.
 - **Cool 1**: Set the color temperature to be cooler than **Normal** mode.
 - **Normal**: Display the standard color tone.
 - **Warm 1**: Set the color temperature to be warmer than **Normal** mode.
 - **Warm 2**: Set the color temperature to be warmer than **Warm 1**.
 - **Custom**: Customize the color tone.
- When the external input is connected through HDMI/MINI DP and **PC/AV Mode** is set to **AV**, **Color Tone** has four color temperature settings (**Cool**, **Normal**, **Warm** and **Custom**).
- **Gamma**: Adjust the middle level of luminance.
 - **Mode1** / **Mode2** / **Mode3**

SAMSUNG MAGIC Upscale

SAMSUNG MAGIC Upscale function can enhance the layers of the picture details and the vividness of the picture.

The function has more obvious effects on low-resolution pictures.

— This menu is not available when **SAMSUNG MAGIC Bright** is set to **Cinema** or **Dynamic Contrast** mode.

— This menu is not available when **Game Mode** is enabled.

- **Off / Mode1 / Mode2**

— Comparing with **Mode1, Mode2** has a stronger effect.

HDMI Black Level

If a DVD player or set-top box is connected to the product via HDMI, image quality degradation (contrast/color degradation, black level, etc.) may occur, depending on the connected source device.

In such case, **HDMI Black Level** can be used to adjust the image quality.

— This function is only available in **HDMI** mode.

— Not available when **PIP/PBP Mode** is set to **On**.

- **Normal**: Select this mode when there is no contrast ratio degradation.
- **Low**: Select this mode to reduce the black level and increase the white level when there is a contrast ratio degradation.

— **HDMI Black Level** may not be compatible with some source devices.

— The **HDMI Black Level** feature is only activated at a certain **AV** resolution, such as 720P @ 60 Hz and 1080P @ 60 Hz.

Eye Saver Mode

Set to an optimum picture quality suitable for eye relaxation.

TÜV Rheinland “Low Blue Light Content” is a certification for products which meet requirements for lower blue light levels. When **Eye Saver Mode** is 'On', the blue light that wavelength is around 400nm will decrease, and it will provide an optimum picture quality suitable for eye relaxation. At the same time, the blue light level is lower than in the default settings, and it was tested by TÜV Rheinland and certified as it met the requirements of TÜV Rheinland “Low Blue Light Content” standards.

Game Mode

Configure the product screen settings for game mode.

Use this feature when playing games on a PC or when a game console such as PlayStation™ or Xbox™ is connected.

— This menu is not available when **Eye Saver Mode** is enabled.

— When the product turns off, enters power-saving mode or changes input sources, **Game Mode** turns **Off** even if it is set to **On**.

— If you want to keep **Game Mode** enabled all the time, select **Always On**.

— Not available when **PIP/PBP Mode** is set to **On**.

Response Time

Accelerate the panel response rate to make video appear more vivid and natural.

— Use **Standard** mode when not playing a video or game.

— S27R75*: This menu is not available when **PIP/PBP Mode** is set to **On** and the **Size** is set to  /  (PIP Mode).

— S32R75*: This menu is not available when **PIP/PBP Mode** is set to **On** and the **Size** is set to  /  /  (PIP Mode).

Picture Size

Change the picture size.

— This menu is not available when **PIP/PBP Mode** is set to **On** and the **Size** is set to  (PBP Mode).

In PC mode

- **Auto**: Display the picture according to the aspect ratio of the input source.
- **Wide**: Display the picture in full screen regardless of the aspect ratio of the input source.

In AV mode

- **4:3**: Display the picture with an aspect ratio of 4:3. Suitable for videos and standard broadcasts.
- **16:9**: Display the picture with an aspect ratio of 16:9.
- **Screen Fit**: Display the picture with the original aspect ratio without cutting off.

— The function may not be supported depending on the ports provided with the product.

— Changing the **Picture Size** is available when the following conditions are satisfied.

— The input source is 480p, 576p, 720p, or 1080p and product can display normally (Not every model can support all of these signals.).

— This can only be set when the external input is connected through HDMI/MINI DP and **PC/AV Mode** is set to **AV**.

Screen Adjustment

— This option is only available when **PC/AV Mode** is set to **AV**.

— This menu is only available when **Picture Size** is set to **Screen Fit** in **AV Mode**.

When a 480P or 576P or 720P or 1080P signal is input in **AV mode** and the product can display normally, select **Screen Fit** to adjust horizontal position and vertical position in 0-6 levels.

Configuring H-Position & V-Position

H-Position: Move the screen to the left or right.

V-Position: Move the screen up or down.

Chapter 05

Configuring the PIP/PBP Settings

Function Key Guide →  → PIP/PBP

A detailed description of each function is provided. Refer to your product for details.

— The functions available may vary depending on the product model. The color and shape of parts may differ from what is shown. Specifications are subject to change without notice to improve quality.

PIP/PBP Mode

Enable or disable the **PIP/PBP Mode** function.

The PIP (Picture in Picture) function separates the screen into two parts. One source device is displayed on the main screen at the same time the another source device is displayed in inset windows.

The PBP (Picture by Picture) function separates the screen in half displaying output from two different source devices simultaneously on the left and right sides of the screen.



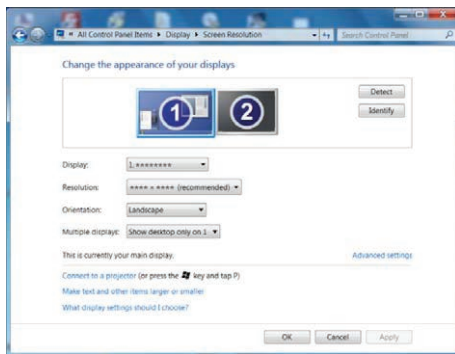



- **PIP/PBP** mode is compatible with Windows 7, Windows 8, and Windows 10.
- The **PIP/PBP** function may not be available depending on the specifications of the graphics card used. If the screen is blank in **PIP/PBP** mode when the optimum resolution is selected, go to **Control Panel** → **Display** → **Screen Resolution** and click **Detect** on the PC. (Instructions are based on Windows 7.) If the screen is blank when the resolution is set to the optimum resolution, change the resolution to 1280 x 1024.



- The screen may flicker briefly or appear after a delay when you enable or disable the **PIP/PBP** function or when you change the screen size with the **PIP/PBP** function activated. This can typically arise when a PC and a product are connected to two or more input sources. It has nothing to do with the performance of a product. The issue is mainly caused when the video signals are delayed in transmission to the product depending on the graphics card performance.
- S27R75*: To obtain optimum picture quality, it is recommended that a graphics card or DVD that supports the QHD (2560 x 1440 @ 144 Hz) resolution be connected to the **HDMI IN** port. To obtain optimum picture quality, it is recommended that a graphics card or DVD that supports the QHD (2560 x 1440 @ 144 Hz) resolution be connected to the **MINI DP IN** port.
- S32R75*: To obtain optimum picture quality, it is recommended that a graphics card or DVD that supports the 4K (3840 x 2160 @ 60 Hz) resolution be connected to either the **HDMI IN** or **MINI DP IN** port.
- When the **PIP/PBP** function is enabled, the resolution will not be able to automatically switch to the optimum resolution due to a compatibility issue between the graphics card and the Windows system. Set **PIP/PBP Mode** to **Off**. Alternatively, restart the product, then set the resolution to the optimum setting using the Windows interface.
- If the product is set to an incompatible resolution, the product may display an abnormal or blank screen. Change to a supported resolution by referring to the Standard Signal Mode Table.





Size

Select the size and aspect ratio of the sub-screen.

- S27R75*:  /  / 
- S32R75*:  /  /  / 

Position

Select the position of the sub-screen from the available options.

-  /  /  / 
 - Not available when PBP is selected.
 - The screen may flicker if the input source is unstable.

Picture Size

Select the image size for each screen.

PBP Mode (available in PBP mode(Size ))

In PC mode

- **Auto**: Display the picture according to the aspect ratio of the each screen input source.
- **Wide**: Display the picture in full screen regardless of the aspect ratio of the each screen input source.

In AV mode

- **4:3**: Display the picture of the sub-screen with an aspect ratio of 4:3. Suitable for videos and standard broadcasts.
- **16:9**: Display the picture of the sub-screen with an aspect ratio of 16:9.
- **Screen Fit**: Display the picture of the sub-screen with the original aspect ratio without cutting anything off.

— The function may not be supported depending on the ports provided with the product.

— Changing the screen size is available when the following conditions are satisfied.

— The input source is 480p, 576p, 720p, or 1080p and product can display normally (Not every model can support all of these signals.).

— This can only be set when the external input is connected through HDMI/MINI DP and **PC/AV Mode** is set to **AV**.

PIP Mode (available in PIP mode (Size / /))

- S27R75*:  / 
- S32R75*:  /  / 

In PC mode

- **Auto**: Display the picture according to the aspect ratio of the each screen input source.
- **Wide**: Display the picture in full screen regardless of the aspect ratio of the each screen input source.

In AV mode

- **4:3**: Display the picture of the sub-screen with an aspect ratio of 4:3. Suitable for videos and standard broadcasts.
 - **16:9**: Display the picture of the sub-screen with an aspect ratio of 16:9.
 - **Screen Fit**: Display the picture of the sub-screen with the original aspect ratio without cutting anything off.
- The function may not be supported depending on the ports provided with the product.
- Changing the screen size is available when the following conditions are satisfied.
- The input source is 480p, 576p, 720p, or 1080p and product can display normally (Not every model can support all of these signals.).
 - This can only be set when the external input is connected through HDMI/MINI DP and **PC/AV Mode** is set to **AV**.

Contrast

PBP Mode (available in PBP mode (Size))

Adjust the contrast level for each screen.

PIP Mode (available in PIP mode (Size / /))

Adjust the contrast level for sub-screen.

Chapter 06

Adjusting OSD (On Screen Display) settings

Function Key Guide →  → [On Screen Display](#)

A detailed description of each function is provided. Refer to your product for details.

— The functions available may vary depending on the product model. The color and shape of parts may differ from what is shown. Specifications are subject to change without notice to improve quality.

Transparency

Set the transparency for the menu windows.

Position

H-Position

Move the menu position to the left or right.

V-Position

Move the menu position up or down.

Language

Set the menu language.

— A change to the language setting will only be applied to the onscreen menu display.

— It will not be applied to other functions on your PC.

Display Time

The OSD menu will automatically disappear if the menu is not used for a specified period of time.

Display Time is a function to specify the time which you want the OSD menu to disappear.

Chapter 07

Setup and Reset

Function Key Guide →  → System

A detailed description of each function is provided. Refer to your product for details.

— The functions available may vary depending on the product model. The color and shape of parts may differ from what is shown. Specifications are subject to change without notice to improve quality.

Self Diagnosis

1 Use the Function Key Guide and go to  → System → Self Diagnosis.

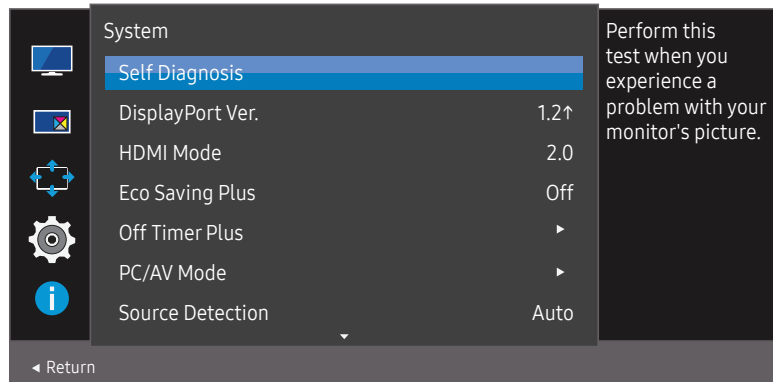

2 Select **OK** when the following screen is prompted.

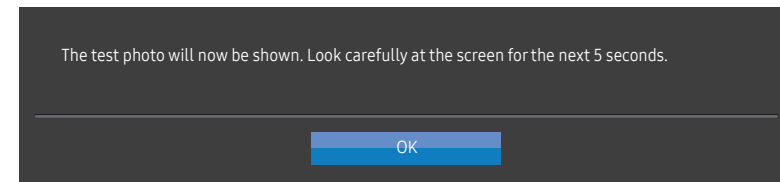

• Review the test screen.

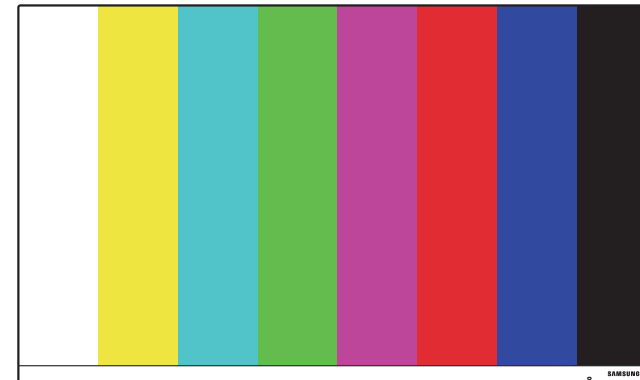

3 Base on the test result, select **Yes / No / Show Again**.

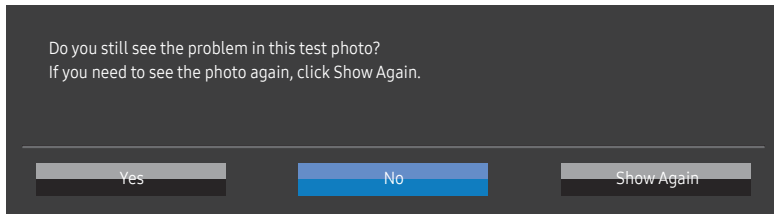

- You will see the following screen when you select **Yes**.

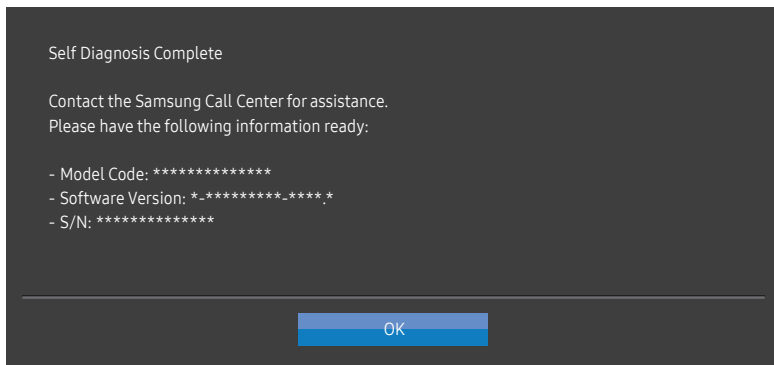

- You will see the following screen when you select **No**.

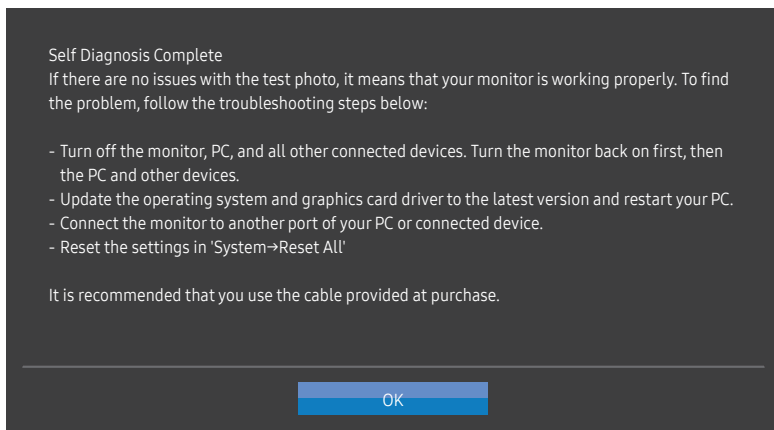

DisplayPort Ver.

Select the DisplayPort version to use.

- Incorrect settings may cause the screen to go blank. If this occurs, check the device specifications.
- If the product (when set to **DisplayPort**) is displaying the message **Check the cable connection and the settings of the source device**, press the JOG button to display the function-button screen and then select  → **System** → **DisplayPort Ver.** → **1.1** or **1.2**↑.

HDMI Mode

Select the HDMI mode to use.

- The supportable device and resolution may differ depending on its version.
- When the version is changed, the screen may blink.
- If you set the **HDMI Mode** to **1.4**, some high resolutions may not be supported because of bandwidth limitation of the HDMI 1.4 protocol.
- When the setting is not appropriate, a blank screen may appear. In this case, check the specifications of the device.
- This menu is not available when **PIP/PBP Mode** is set to **On** and the **Size** is set to  (PBP Mode).

Eco Saving Plus

The **Eco Saving Plus** function reduces power consumption by controlling the electric current used by the product panel.

- This option is not available when **SAMSUNG MAGICBright** is in **Dynamic Contrast** mode.
- This menu is not available when **Game Mode** is enabled.
- This menu is not available when **Eye Saver Mode** is enabled.
- Not available when **PIP/PBP Mode** is set to **On**.
- **Off**: Deactivate the **Eco Saving Plus** function.
- **Auto**: The power consumption will automatically be reduced by about 10% over the current setting. (The reduction of power consumption depends on the customer screen brightness condition.)
- **Low**: The power consumption will be reduced by 25% over the default setting.
- **High**: The power consumption will be reduced by 50% over the default setting.

Off Timer Plus

Configuring Off Timer

Off Timer: Turn on **Off Timer** mode.

Turn Off After: The off timer can be set within a range of 1 to 23 hours. The product will automatically power off after the specified number of hours.

— This option is only available when **Off Timer** is set to **On**.

— For products for the market in some regions, the **Off Timer** is set to automatically activate 4 hours after the product powers on. This is done in accordance with power supply regulations. If you do not want the timer to activate, go to **III** → **System** → **Off Timer Plus** and set **Off Timer** to **Off**.

Configuring Eco Timer

Eco Timer: Turn on **Eco Timer** mode.

Eco Off After: The **Eco Timer** can be set between 10 and 180 minutes. The product will automatically power off after the specified time has elapsed.

— This option is only available when **Eco Timer** is set to **On**.

PC/AV Mode

Set **PC/AV Mode** to **AV**. The picture size will be enlarged.

This option is useful when you view a movie.

- Set to **PC** when connected to a PC.
- Set to **AV** when connected to an AV device.

— Products with a display area of 16:9 or 16:10 are only supported.

— If the product is in **HDMI, DisplayPort** mode and the screen says **Check the cable connection and the settings of the source device**, press the JOG button to display the function-button screen and then select **III** → **System** → **PC/AV Mode** → **HDMI, DisplayPort** → **PC** or **AV**.

Source Detection

Select either **Auto** or **Manual** as the method to recognize input source.

— Not available when **PIP/PBP Mode** is set to **On**.

Key Repeat Time

Control the response rate of a button when the button is pressed.

Acceleration, **1 sec**, or **2 sec** can be selected. If **No Repeat** is selected, a command responds only once when a button is pressed.

Power LED On

Configure the settings to enable or disable the power LED located at the lower part of the product.

- **Working**: The power LED is on when the product is turned on.
- **Stand-by**: The power LED is on when the product is turned off.

Reset All

Return all the settings for the product to the default factory settings.

Chapter 08

Information

Function Key Guide →  → Information

A detailed description of each function is provided. Refer to your product for details.

— The functions available may vary depending on the product model. The color and shape of parts may differ from what is shown. Specifications are subject to change without notice to improve quality.

Information

View the current input source mode, frequency and resolution that are in use and the current product version.

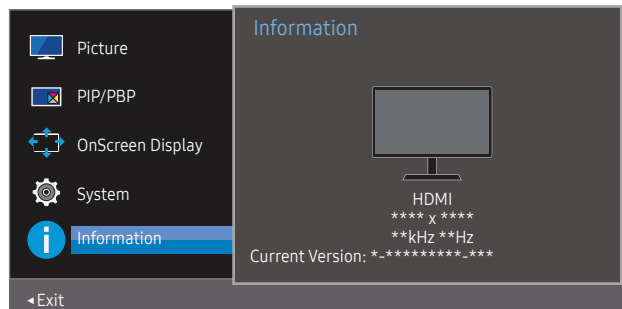

— The displayed image may differ depending on the model.

PIP

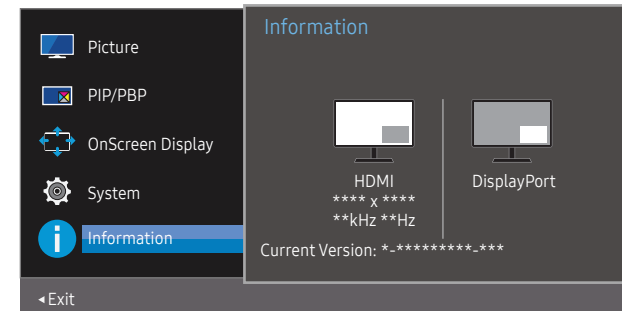

PBP

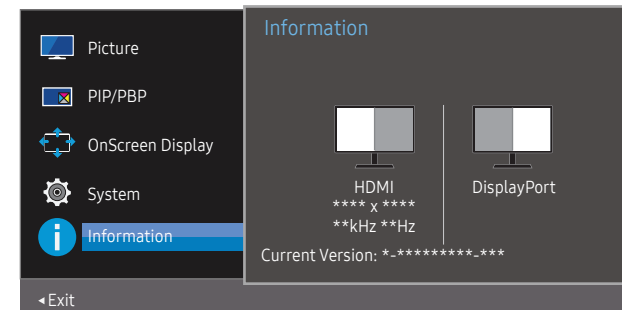

Chapter 09

Installing the Software

Easy Setting Box



Easy Setting Box enables users to use the product by partitioning multiple sections.

To install the latest version of Easy Setting Box, download it from the Samsung Electronics website at <http://www.samsung.com>.

- The software may not work properly if you do not restart the PC after the installation.
- The Easy Setting Box icon may not appear depending on the PC system and the product specifications.
- If the shortcut icon does not appear, press the F5 key.

Restrictions and Problems with the Installation

The Easy Setting Box installation may be affected by the Graphics Card, Motherboard and the Networking Environment.

Upgrade by downloading the firmware from the website

Visit the Samsung Electronics website at <http://www.samsung.com>, enter the product model and download the firmware file.

- For details on how to upgrade, refer to the upgrade guidance file provided at the website.

System Requirements

OS	Hardware
<ul style="list-style-type: none">• Windows 7 32Bit/64Bit	<ul style="list-style-type: none">• At least 32MB of memory
<ul style="list-style-type: none">• Windows 8 32Bit/64Bit	<ul style="list-style-type: none">• At least 60MB of free space on the hard disk drive
<ul style="list-style-type: none">• Windows 8.1 32Bit/64Bit	
<ul style="list-style-type: none">• Windows 10 32Bit/64Bit	

Chapter 10

Troubleshooting Guide

Requirements Before Contacting Samsung Customer Service Center

— Before calling Samsung Customer Service Center, test your product as follows. If the problem persists, contact Samsung Customer Service Center.

Product diagnosis (Screen issue)

If a problem occurs with the product screen, run [Self Diagnosis](#) to check that the product is working properly.

Checking the Resolution and Frequency

If a resolution that is not supported (see the [Standard Signal Mode Table](#)) is selected, the **Not Optimum Mode** message may appear for a short time or the screen may not be displayed properly.

— The displayed resolution may vary, depending on the PC system settings and cables.

Check the following.

Installation issue

The screen keeps switching on and off.

Check the cable connection between the product and PC, and ensure the connectors are locked.

Blank spaces are found on all four sides of the screen when an HDMI cable is connected to the product and PC.

The blank spaces found on the screen have nothing to do with the product.

Blank spaces on the screen are caused by the PC or graphics card. To resolve the problem, adjust the screen size in the HDMI or DVI settings for the graphics card.

If the graphics card settings menu does not have an option to adjust the screen size, update the graphics card driver to the latest version.

(Please contact the graphics card or PC manufacturer for further details about how to adjust the screen settings.)

The power plug cannot be removed from the power adapter.

Do not remove the power plug after assembly.

Screen issue

The power LED is off. The screen will not switch on.

Check that the power cable is connected properly.

If a problem occurs with the product screen, run [Self Diagnosis](#) to check that the product is working properly.

The message **Check the cable connection and the settings of the source device.** appears.

Check that the cable is properly connected to the product.

Check that the device connected to the product is powered on.

If the product is in **HDMI** or **DisplayPort** mode, press the JOG button to display the function-button screen and select the  icon.

Not Optimum Mode is displayed.

This message appears when the signal from the graphics card exceeds the maximum resolution or frequency for the product.

Change the maximum resolution and frequency to suit the product performance, referring to Standard Signal Mode Table ([P.46](#)).

The images on the screen look distorted.

Check the cable connection to the product.

The screen is not clear. The screen is blurry.

Remove any accessories (video extension cable, etc.) and try again.

Set the resolution and frequency to the recommended level.

The screen appears unstable and shaky. There are shadows or ghost images left on the screen.

Check that the resolution and frequency for the PC are within the range of resolution and frequency compatible with the product. Next, if required, change the settings, referring to Standard Signal Mode Table ([P.46](#)) in this manual and the **Information** menu on the product.

The screen is too bright. The screen is too dark.

Adjust **Brightness** and **Contrast**.

Screen color is inconsistent.

Change the **Color** settings.

The colors on the screen have a shadow and are distorted.

Change the **Color** settings.

White does not really look white.

Change the **Color** settings.

There is no image on the screen and the power LED blinks every 0.5 to 1 second.

The product is operating in power-saving mode.

Press any key on the keyboard or move the mouse to return to normal operating mode.

Text is blurry.

If using a Windows OS (e.g. Windows 7, Windows 8, Windows 8.1 or Windows 10): Go to **Control Panel** → **Fonts** → **Adjust ClearType text** and change **Turn on ClearType**.

Video playback is choppy.

Playback of high-definition large video files can be choppy. This may be because the video player is not optimized for the PC resource.

Try playing the file on another video player.

Source device issue

A beeping sound is heard when my PC is booting.

If a beeping sound is heard when your PC is booting, have your PC serviced.

Q & A

— Refer to the user manual for your PC or graphics card for further instructions on adjustment.

How can I change the frequency?

Set the frequency on your graphics card.

- Windows 7: Go to Control Panel → Appearance and Personalization → Display → Screen Resolution → Advanced settings → Monitor, and adjust Screen Refresh Rate under Monitor settings.
- Windows 8(Windows 8.1): Go to Settings → Control Panel → Appearance and Personalization → Display → Screen Resolution → Advanced settings → Monitor, and adjust Refresh rate under Monitor settings.
- Windows 10: Go to Settings → System → Display → Advanced display settings → Display adapter properties → Monitor, and adjust Screen refresh rate under Monitor settings.

How can I change the resolution?

- Windows 7: Go to Control Panel → Appearance and Personalization → Display → Screen Resolution → Adjust Resolution.
- Windows 8(Windows 8.1): Go to Settings → Control Panel → Appearance and Personalization → Display → Adjust Resolution, and adjust the resolution.
- Windows 10: Go to Settings → System → Display → Advanced display settings, and adjust the resolution.

How do I set power-saving mode?

- Windows 7: Go to Control Panel → Appearance and Personalization → Personalization → Screen Saver Settings → Power options or BIOS SETUP on the PC.
 - Windows 8(Windows 8.1): Go to Settings → Control Panel → Appearance and Personalization → Personalize → Screen Saver Settings → Power options or BIOS SETUP on the PC.
 - Windows 10: Go to Settings → Personalization → Lock screen → Screen timeout settings → Power & sleep or BIOS SETUP on the PC.
-

Chapter 11

Specifications

General

Model Name	S27R75*	S32R75*
Size	27 Class (27 Inches / 68.4 cm)	32 Class (31.5 Inches / 80.0 cm)
Display area	596.736 mm (H) x 335.664 mm (V) 23.5 Inches (H) x 13.2 Inches (V)	697.3 mm (H) x 392.2 mm (V) 27.5 Inches (H) x 15.4 Inches (V)
Pixel Pitch	0.2331 mm (H) x 0.2331 mm (V) 0.009177 Inches (H) x 0.009177 Inches (V)	0.06 mm (H) x 0.181 mm (V) 0.002362 Inches (H) x 0.007126 Inches (V)
Maximum Pixel Clock	594 MHz (HDMI)	
Power Supply	AC100-240V~ 50/60Hz Based on the AC voltage of the adapter. For the DC voltage of the product, refer to the product label.	
Signal connectors	HDMI, MINI DisplayPort	
Environmental conditions	Operating Temperature: 50 °F – 104 °F (10 °C – 40 °C) Humidity: 10 % – 80 %, non-condensing <hr/> Storage Temperature: -4 °F – 113 °F (-20 °C – 45 °C) Humidity: 5 % – 95 %, non-condensing	

- Plug-and-Play
This product can be installed and used with any Plug-and-Play compatible systems. Two-way data exchange between the product and PC system optimizes the product settings. Product installation takes place automatically. However, you can customize the installation settings if desired.
- Panel Dots (Pixels)
Due to the nature of the manufacturing of this product, approximately 1 pixel per million (1ppm) may be brighter or darker on the LCD panel. This does not affect product performance.
- The above specifications are subject to change without notice to improve quality.
- This device is a Class B digital apparatus.
- For detailed device specifications, visit the Samsung Electronics website.

(USA only)

Dispose unwanted electronics through an approved recycler.

To find the nearest recycling location, go to our website:

www.samsung.com/recyclingdirect or call, 1-800-SAMSUNG

Standard Signal Mode Table

Model Name	S27R75*		S32R75*	
Synchronization	Horizontal Frequency	70.56 ~ 214.56 kHz	147.78 ~ 148.38 kHz	
	Vertical Frequency	48 ~ 144 Hz (DisplayPort / HDMI)	60 Hz (DisplayPort / HDMI)	
Resolution	Optimum Resolution	2560 x 1440 @ 144 Hz (DisplayPort / HDMI)	3840 x 2160 @ 60 Hz (DisplayPort / HDMI)	
	Maximum Resolution			

If a signal that belongs to the following standard signal modes is transmitted from your PC, the screen will automatically be adjusted. If the signal transmitted from the PC does not belong to the standard signal modes, the screen may be blank even though the power LED turns on. In such a case, change the settings according to the following table by referring to the graphics card user manual.

DisplayPort (S27R75*)

Resolution	Horizontal Frequency (kHz)	Vertical Frequency (Hz)	Pixel Clock (MHz)	Sync Polarity (H/V)
IBM, 720 x 400	31.469	70.087	28.322	-/+
MAC, 640 x 480	35.000	66.667	30.240	-/-
MAC, 832 x 624	49.726	74.551	57.284	-/-
MAC, 1152 x 870	68.681	75.062	100.000	-/-
VESA DMT, 640 x 480	31.469	59.940	25.175	-/-
VESA DMT, 640 x 480	37.861	72.809	31.500	-/-
VESA DMT, 640 x 480	37.500	75.000	31.500	-/-
VESA DMT, 800 x 600	35.156	56.250	36.000	+/+
VESA DMT, 800 x 600	37.879	60.317	40.000	+/+
VESA DMT, 800 x 600	48.077	72.188	50.000	+/+
VESA DMT, 800 x 600	46.875	75.000	49.500	+/+
VESA DMT, 1024 x 768	48.363	60.004	65.000	-/-
VESA DMT, 1024 x 768	56.476	70.069	75.000	-/-
VESA DMT, 1024 x 768	60.023	75.029	78.750	+/+
VESA DMT, 1152 x 864	67.500	75.000	108.000	+/+
VESA DMT, 1280 x 720	45.000	60.000	74.250	+/+

DisplayPort (S27R75*)

Resolution	Horizontal Frequency (kHz)	Vertical Frequency (Hz)	Pixel Clock (MHz)	Sync Polarity (H/V)
VESA DMT, 1280 x 800	49.702	59.810	83.500	-/+
VESA DMT, 1280 x 1024	63.981	60.020	108.000	+/+
VESA DMT, 1280 x 1024	79.976	75.025	135.000	+/+
VESA DMT, 1440 x 900	55.935	59.887	106.500	-/+
VESA DMT, 1600 x 900	60.000	60.000	108.000	+/+
VESA DMT, 1680 x 1050	65.290	59.954	146.250	-/+
VESA DMT, 1920 x 1080	67.500	60.000	148.500	+/+
VESA CVT, 2560 x 1440	88.787	59.951	241.500	+/-
VESA CVT, 2560 x 1440	150.919	99.946	410.500	+/-
VESA CVT, 2560 x 1440	182.996	119.998	497.750	+/-
VESA CVT, 2560 x 1440	222.192	144.000	586.586	+/-

HDMI (S27R75*)

Resolution	Horizontal Frequency (kHz)	Vertical Frequency (Hz)	Pixel Clock (MHz)	Sync Polarity (H/V)
IBM, 720 x 400	31.469	70.087	28.322	-/+
MAC, 640 x 480	35.000	66.667	30.240	-/-
MAC, 832 x 624	49.726	74.551	57.284	-/-
MAC, 1152 x 870	68.681	75.062	100.000	-/-
VESA DMT, 640 x 480	31.469	59.940	25.175	-/-
VESA DMT, 640 x 480	37.861	72.809	31.500	-/-
VESA DMT, 640 x 480	37.500	75.000	31.500	-/-
VESA DMT, 800 x 600	35.156	56.250	36.000	+/+
VESA DMT, 800 x 600	37.879	60.317	40.000	+/+
VESA DMT, 800 x 600	48.077	72.188	50.000	+/+
VESA DMT, 800 x 600	46.875	75.000	49.500	+/+
VESA DMT, 1024 x 768	48.363	60.004	65.000	-/-

HDMI (S27R75*)

Resolution	Horizontal Frequency (kHz)	Vertical Frequency (Hz)	Pixel Clock (MHz)	Sync Polarity (H/V)
VESA DMT, 1024 x 768	56.476	70.069	75.000	-/-
VESA DMT, 1024 x 768	60.023	75.029	78.750	+/+
VESA DMT, 1152 x 864	67.500	75.000	108.000	+/+
VESA DMT, 1280 x 720	45.000	60.000	74.250	+/+
VESA DMT, 1280 x 800	49.702	59.810	83.500	-/+
VESA DMT, 1280 x 1024	63.981	60.020	108.000	+/+
VESA DMT, 1280 x 1024	79.976	75.025	135.000	+/+
VESA DMT, 1440 x 900	55.935	59.887	106.500	-/+
VESA DMT, 1600 x 900	60.000	60.000	108.000	+/+
VESA DMT, 1680 x 1050	65.290	59.954	146.250	-/+
VESA DMT, 1920 x 1080	67.500	60.00	148.500	+/+
VESA CVT, 2560 x 1440	88.787	59.951	241.500	+/-
VESA CVT, 2560 x 1440	150.919	99.946	410.500	+/-
VESA CVT, 2560 x 1440	182.996	119.998	497.750	+/-
Unique Custom Timing, 2560 x 1440	222.192	144.000	596.807	+/-

DisplayPort (S32R75*)

Resolution	Horizontal Frequency (kHz)	Vertical Frequency (Hz)	Pixel Clock (MHz)	Sync Polarity (H/V)
IBM, 720 x 400	31.469	70.087	28.322	-/+
VESA, 640 x 480	31.469	59.940	25.175	-/-
MAC, 640 x 480	35.000	66.667	30.240	-/-
VESA, 640 x 480	37.861	72.809	31.500	-/-
VESA, 640 x 480	37.500	75.000	31.500	-/-
VESA, 800 x 600	35.156	56.250	36.000	+/+
VESA, 800 x 600	37.879	60.317	40.000	+/+
VESA, 800 x 600	48.077	72.188	50.000	+/+
VESA, 800 x 600	46.875	75.000	49.500	+/+

DisplayPort (S32R75*)

Resolution	Horizontal Frequency (kHz)	Vertical Frequency (Hz)	Pixel Clock (MHz)	Sync Polarity (H/V)
MAC, 832 x 624	49.726	74.551	57.284	-/-
VESA, 1024 x 768	48.363	60.004	65.000	-/-
VESA, 1024 x 768	56.476	70.069	75.000	-/-
VESA, 1024 x 768	60.023	75.029	78.750	+/+
VESA, 1152 x 864	67.500	75.000	108.000	+/+
MAC, 1152 x 870	68.681	75.062	100.000	-/-
VESA, 1280 x 720	45.000	60.000	74.250	+/+
VESA, 1280 x 800	49.702	59.810	83.500	-/+
VESA, 1280 x 1024	63.981	60.020	108.000	+/+
VESA, 1280 x 1024	79.976	75.025	135.000	+/+
VESA, 1440 x 900	55.935	59.887	106.500	-/+
VESA, 1600 x 900	60.000	60.000	108.000	+/+
VESA, 1680 x 1050	65.290	59.954	146.250	-/+
VESA, 1920 x 1080	67.500	60.000	148.500	+/+
VESA, 2560 x 1440	88.787	59.951	241.500	+/-
VESA, 3840 x 2160	133.313	59.997	533.250	+/-

HDMI (S32R75*)

Resolution	Horizontal Frequency (kHz)	Vertical Frequency (Hz)	Pixel Clock (MHz)	Sync Polarity (H/V)
IBM, 720 x 400	31.469	70.087	28.322	-/+
VESA, 640 x 480	31.469	59.940	25.175	-/-
MAC, 640 x 480	35.000	66.667	30.240	-/-
VESA, 640 x 480	37.861	72.809	31.500	-/-
VESA, 640 x 480	37.500	75.000	31.500	-/-
VESA, 800 x 600	35.156	56.250	36.000	+/+
VESA, 800 x 600	37.879	60.317	40.000	+/+
VESA, 800 x 600	48.077	72.188	50.000	+/+
VESA, 800 x 600	46.875	75.000	49.500	+/+

HDMI (S32R75*)

Resolution	Horizontal Frequency (kHz)	Vertical Frequency (Hz)	Pixel Clock (MHz)	Sync Polarity (H/V)
MAC, 832 x 624	49.726	74.551	57.284	-/-
VESA, 1024 x 768	48.363	60.004	65.000	-/-
VESA, 1024 x 768	56.476	70.069	75.000	-/-
VESA, 1024 x 768	60.023	75.029	78.750	+/+
VESA, 1152 x 864	67.500	75.000	108.000	+/+
MAC, 1152 x 870	68.681	75.062	100.000	-/-
VESA, 1280 x 720	45.000	60.000	74.250	+/+
VESA, 1280 x 800	49.702	59.810	83.500	-/+
VESA, 1280 x 1024	63.981	60.020	108.000	+/+
VESA, 1280 x 1024	79.976	75.025	135.000	+/+
VESA, 1440 x 900	55.935	59.887	106.500	-/+
VESA, 1600 x 900	60.000	60.000	108.000	+/+
VESA, 1680 x 1050	65.290	59.954	146.250	-/+
VESA, 1920 x 1080	67.500	60.000	148.500	+/+
VESA, 2560 x 1440	88.787	59.951	241.500	+/-
CEA, 3840 x 2160	135.000	60.000	594.000	+/+

Horizontal Frequency

The time required to scan a single line from the left to the right side of the screen is called a horizontal cycle. The reciprocal number of a horizontal cycle is called horizontal frequency. Horizontal frequency is measured in kHz.

Vertical Frequency

Repeating the same picture dozens of times per second allows you to view natural pictures. The repeat frequency is called "vertical frequency" or "refresh rate" and is indicated in Hz.

This product can be set to only one resolution for each screen size to obtain the optimum picture quality due to the nature of the panel. Using a resolution other than the specified resolution may degrade the picture quality. To avoid this, it is recommended that you select the optimum resolution specified for your product.

Some resolutions listed in the table above may not be available depending on graphics card specifications.

Chapter 12

Appendix

Responsibility for the Pay Service (Cost to Customers)

— When the service is requested, in spite of in warranty, we may charge you for a visit from a service technician in the following cases.

Not a product defect

Cleaning of the product, Adjustment, Explanation, Re-installation and etc.

- If a service technician is requested to give instructions on how to use product or simply adjusts options without disassembling product.
- If a defect is caused by external environmental factors (Internet, Antenna, Wired Signal, etc.)
- If a product is reinstalled or devices are connected additionally after installing the purchased product for the first time.
- If a product is reinstalled to move to a different spot or to move to a different house.
- If the customer requests instructions on how to use another company's product.
- If customer requests instructions on how to use the network or another company's Program.
- If customer requests software installation and setup for the product.
- If a service technician removes/cleans dusts or foreign materials inside of the product.
- If customer requests an installation additionally after purchasing a product through home-shopping or online.

A Product damage caused by customer's fault

Product damage caused by customer's mishandling or wrong repair

If a product damage is caused by;

- External impact or drop.
- Use of supplies or separately sold product unspecified by Samsung.
- Repair from a person besides an engineer of outsourcing service company or partner of Samsung Electronics Co., Ltd.
- Remodeling or repairing the product by customer.
- Using it with incorrect voltage or non-authorized electrical connections.
- Not following the "cautions" in User Manual.

Others

- If product fails by natural disaster. (lightning, fire, earthquake, flood damage, etc)
- If consumable components are all used up. (Battery, Toner, Fluorescent lights, Head, Vibrator, Lamp, Filter, Ribbon, etc.)

— If customer requests a service in case the product has no defect, service fee may be charged. So please read User Manual first.