



USER MANUAL

Levoit Core[®] Mini True HEPA Air Purifier

Models: LAP-C161-WUS, LAP-C161-KUS



Questions or Concerns?

Please contact us Mon–Fri, 9:00 am–5:00 pm PST/PDT at support@levoit.com or at **(888) 726-8520**.

Table of Contents

Package Contents	2
Specifications	2
Safety Information	3
Getting to Know Your Air Purifier	4
Getting Started	5
Using Your Air Purifier	6
Care & Maintenance	7
Troubleshooting	9
Warranty Information	11
Customer Support	11

Package Contents (1-Pack)

- 1 × Core Mini True HEPA Air Purifier
- 1 × 3-Stage H13 True HEPA Filter (Pre-Installed)
- 1 × Aroma Pad (Pre-Installed)
- 1 × AC Power Adapter
- 1 × User Manual

Package Contents (2-Pack)

- 2 × Core Mini True HEPA Air Purifier
- 2 × 3-Stage H13 True HEPA Filter (Pre-Installed)
- 2 × Aroma Pad (Pre-Installed)
- 2 × AC Power Adapter
- 1 × User Manual

Specifications

Power Supply	12V $\overline{\text{DC}}$ 1A
Rated Power	7W
Ideal Room Size	169 ft ² / 16 m ² Note: <ul style="list-style-type: none">Effective for larger rooms, but purification will take longer.Ideal Room Size is based on 2 air changes per hour (ACH).
Operating Conditions	Temperature: 14°–104°F / -10°–40°C
	Humidity: ≤ 85% RH
Noise Level	27–44dB
Air Purifier Dimensions	6.5 × 6.5 × 10.4 in / 16.4 × 16.4 × 26.4 cm
Air Purifier Weight	2.2 lb / 1.0 kg
Power Adapter	Input: 100–240V~ 50/60Hz
	Output: 12V $\overline{\text{DC}}$ 1A

READ AND SAVE THESE INSTRUCTIONS

SAFETY INFORMATION

To reduce the risk of fire, electric shock, or other injury, follow all instructions and safety guidelines.

General Safety

- **Only** use your air purifier as described in this manual.
- **Do not** use without removing the plastic wrap from the filter. The air purifier will not filter air, and may overheat, causing a fire hazard.
- **Do not** use the air purifier outdoors.
- Keep the air purifier away from water, and wet or damp areas. **Never** place in water or liquid.
- **Do not** use in excessively humid areas.
- Keep the air purifier away from heat sources.
- **Do not** use where combustible gases, vapors, metallic dust, aerosol (spray) products, or fumes from industrial oil are present.
- Keep 5 ft / 1.5 m away from where oxygen is being administered.
- Supervise children when they are near the air purifier. **Do not** allow children to play with the air purifier.
- **Do not** place anything into any opening in the air purifier.
- **Do not** sit on or place heavy objects on the air purifier.
- Keep the inside of the air purifier dry. To prevent moisture buildup, avoid placing in rooms with major temperature changes or underneath air conditioners.
- **Always** unplug the air purifier before servicing (such as changing the filter).
- **Do not** add essential oils to the filter. The filter will be damaged by the oil and will eventually release an unpleasant smell. **Only** add essential oils (not included) to the aroma box near the top of the air purifier.
- **Do not** use the air purifier if it is damaged or not working correctly, or if the cord or plug is damaged. Do not try to repair it yourself. Contact **Customer Support** (see page 11).
- **WARNING:** To reduce the risk of fire or electric shock, do not use this air purifier with any solid-state speed controls (such as a dimmer switch).
- Children should not clean or perform maintenance on the air purifier without supervision.
- This air purifier is not to be used by persons (including children) with reduced physical, sensory, or mental capacities, or lack of experience and knowledge, unless they have been given supervision or instruction concerning the use of the appliance by a person responsible for their safety.
- Not for commercial use. Household use **only**.

Power Adapter & Cord

- Keep the air purifier near the outlet it is plugged into.
- **Never** place the cord near any heat source.
- **Do not** cover the cord with a rug, carpet, or other covering. **Do not** place the cord under furniture or appliances.
- Keep the cord out of areas where people walk often. Place the cord where it will not be tripped over.
- This air purifier uses standard North American 120V, 60Hz outlets. If using outside the US or Canada, check for compatibility.
- If the power adapter cord is damaged, it must be replaced by Arovast Corporation or similarly qualified persons in order to avoid an electric or fire hazard. Please contact **Customer Support** (page 11).

Electromagnetic Fields (EMF)

Your Levoit air purifier complies with all standards regarding electromagnetic fields (EMF). If handled properly and according to the instructions in this user manual, the appliance is safe to use based on scientific evidence available today.

GETTING TO KNOW YOUR AIR PURIFIER

- A. Check Filter Indicator
- B. Fan Speed Indicators
- C. Control Button
- D. Air Outlet
- E. Air Inlets
- F. Aroma Pad
- G. Aroma Box
- H. Air Purifier Bottom
- I. Air Purifier Top
- J. AC Power Adapter Input
- K. 3-Stage H13 True HEPA Filter
- L. AC Power Adapter

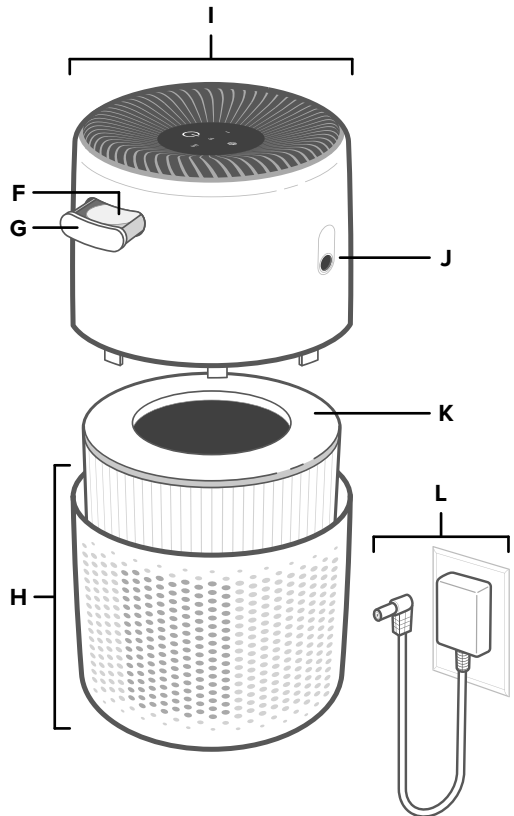
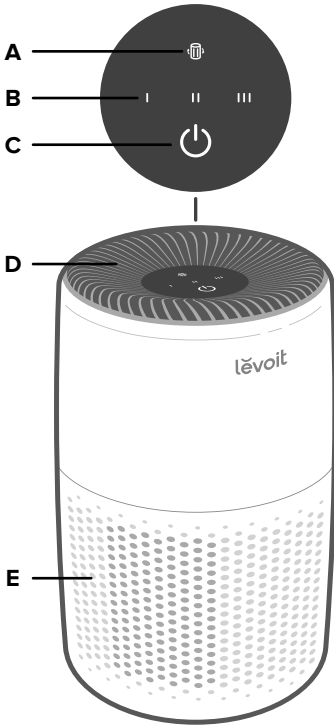

GETTING STARTED

IMPORTANT:

- The AC power adapter comes stored inside the air purifier.
- You must remove the plastic from the filter before using.

1. Remove all packaging, including any tape on the aroma box (see page 8).
2. Rotate the top half of the air purifier counterclockwise and remove it from the bottom half. [Figure 1.1]
3. Remove the filter and AC power adapter from inside the air purifier. Remove all plastic packaging from the filter. Place the filter back into the air purifier. [Figure 1.2]

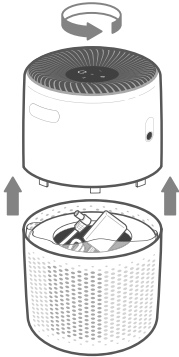

Figure 1.1

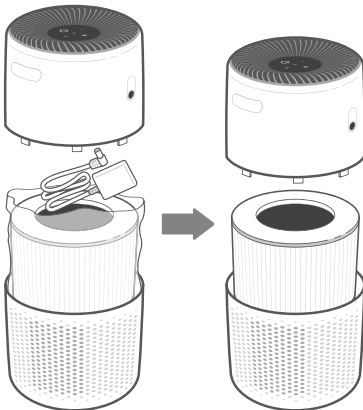

Figure 1.2

4. Place the top half of the air purifier directly back onto the bottom half of the air purifier. Rotate clockwise to secure both halves in place. [Figure 1.3]

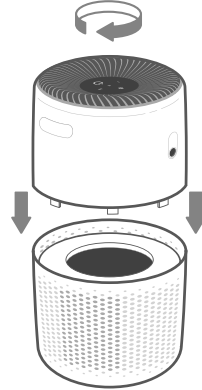

Figure 1.3

5. Connect the AC power adapter to the air purifier. Plug into an outlet.
6. To allow air to circulate freely in and out of the air purifier, there should ideally be 15 inches / 38 cm of clearance on all sides of the air purifier. [Figure 1.4]

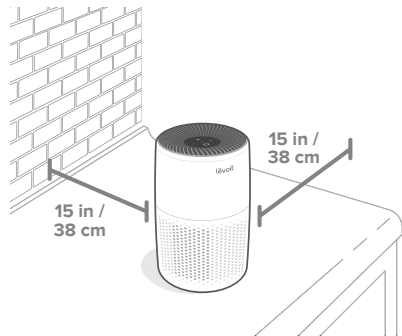

Figure 1.4

USING YOUR AIR PURIFIER

WARNING: Make sure the air outlet and the air inlets are not blocked. This may cause the air purifier to overheat and stop working.

1. Tap the Control Button to turn on the air purifier.
2. Optionally, press the Control Button repeatedly to change fan speed between I, II, and III, and to turn the air purifier off.

Note: The display lights will automatically turn off after 60 seconds of inactivity.

Essential Oils

Do not add essential oils to the filter or the fan. The filter will be damaged by the oil and will eventually release an unpleasant smell. **Only** add essential oils to the aroma pad, located in the aroma box near the top of the air purifier.

Note: Essential oils are not included.

Adding Essential Oils

1. Push in the aroma box and pull it out.
2. Add 5–7 drops of essential oil to the aroma pad.
3. Place the aroma box back into the air purifier.

Note: Do not mix essential oil blends. Clean the aroma pad before using a new essential oil blend (see **Cleaning the Aroma Pad**, page 8).

Humidity

Moisture may damage the filter. This air purifier should be used in an area with a humidity level below 85% RH. If you use the air purifier in excessively humid areas, the surface of the filter may become moldy.

Note: Water or moisture will allow mold to grow. To solve a mold problem, get rid of the source of the moisture and clean up the mold.

About the Filters

The air purifier uses a 3-stage H13 True HEPA filtration system to purify air.

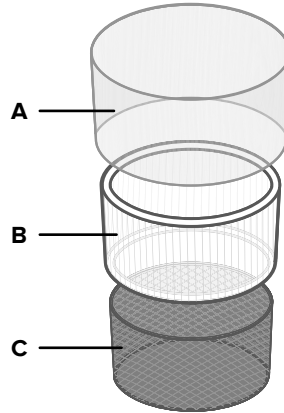

A. Pre-Filter

- Captures large particles such as dust, lint, fibers, hair, and pet fur.
- Maximizes the filter's life by protecting it.

B. H13 True HEPA Filter

- Traps at least 99.97% of airborne particles 0.3 microns in size.
- Traps airborne particles such as fine dust, smoke particles, and allergens such as pollen and pet dander.

C. Activated Carbon Filter

- Physically adsorbs smoke, odors, and fumes.

Note: Arovast Corporation makes no claims that this air purifier helps reduce the COVID-19 virus.

CARE & MAINTENANCE

Cleaning the Air Purifier

1. Unplug before cleaning.

Note: Do not clean with abrasive chemicals or flammable cleaning agents.

2. Wipe the outside of the air purifier with a soft, dry cloth. If necessary, wipe with a damp cloth, then immediately dry.
3. Vacuum the inside of the air purifier using a vacuum hose with a crevice attachment. **[Figure 2.1]**

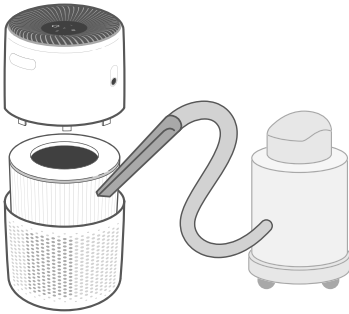

Figure 2.1

Cleaning the Filter

The outer pre-filter should be cleaned every 2–4 weeks to increase efficiency and extend the life of your filter. Clean the pre-filter using a soft brush or vacuum hose to remove hair, dust, and large particles. **Do not** clean the filter with water or other liquids.

Check Filter Indicator

☑ will light up as a reminder to check the filter. Depending on how often you use the air purifier, the indicator should turn on after about 4–6 months. You may not need to change your filter yet, but you should check it when ☑ turns on.

Resetting the Check Filter Indicator

Reset the Check Filter Indicator when:

- A. ☑ lights up red.
 1. Replace the filter (see page 8).
 2. With the air purifier plugged in and the fan turned off, press and hold the Control Button for 3 seconds.
 3. ☑ will blink 3 times and turn off when successfully reset.
- B. The filter was changed before ☑ lit up.
 1. With the air purifier plugged in and the fan turned off, press and hold the Control Button for 3 seconds. This will turn on ☑.
 2. Press and hold the Control Button again for 3 seconds.
 3. ☑ will blink 3 times and turn off when successfully reset.

Filter	When to Clean	How to Clean	When to Replace
Pre-Filter	Every 2–4 weeks	Use a soft brush or vacuum hose [Figure 2.1]	4–6 months
H13 True HEPA & Activated Carbon Filter	Do not clean		

CARE & MAINTENANCE (CONT.)

When Should I Replace the Filter?

The filter should be replaced every 4–6 months. You may need to replace your filter earlier or later depending on how often you use your air purifier. Using your air purifier in an environment with relatively high pollution may mean you will need to replace the filter more often, even if  is off.

You may need to replace your filter if you notice:

- Increased noise when the air purifier is on
- Decreased airflow
- Unusual odors
- A visibly clogged filter

Note:

- To maintain the performance of your air purifier, **only** use official Levoit filters. For more information, contact **Customer Support** (see page 11).
- Remember to reset  after changing the filter (see page 7).

Replacing the Filter

1. Unplug and pick up the air purifier. Separate the two halves of the air purifier (see **Getting Started**, page 5).
2. Remove the old filters.
3. Clean out any remaining dust or hair inside the air purifier using a vacuum hose.

Note: If you remove and set aside the top half of the air purifier, you can use water to clean the bottom half of the air purifier. **Do not** use water or liquids to clean the top half of the air purifier. [Figure 2.2]

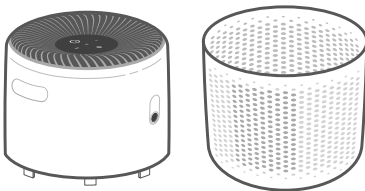

Figure 2.2

4. Unwrap the new filter and place it into the bottom half of the air purifier (see **Getting Started**, page 5).
5. Put the two halves of the air purifier securely back together. Plug in the air purifier.
6. Reset the Check Filter Indicator (see page 7).

Cleaning the Aroma Pad

For effective aromatherapy, the aroma pad should always be cleaned before using a new essential oil blend. **Do not** mix essential oil blends.

To clean:

1. Remove the aroma box by pressing it in, then pulling it out.
2. Remove the aroma pad and rinse under warm, running water.
3. Dry with a clean cloth and place it back into the aroma box.
4. Place the aroma box back inside the air purifier.

Note: **Do not** pour liquid cleaners or detergents into the aroma pad or box.

Replacing the Aroma Pad

If the aroma pad becomes deformed or damaged after repeated washing, it may need to be replaced.

To maintain the performance of your air purifier, only use official Levoit aroma pads. For more information, contact **Customer Support** (see page 11).







Storage

If not using the air purifier for an extended period of time, wrap both the air purifier and the filter in plastic packaging and store in a dry place to avoid moisture damage.

TROUBLESHOOTING

Problem	Possible Solution
Air purifier will not turn on or respond to button controls.	Plug in the air purifier.
	Disconnect the AC power adapter from the air purifier and reconnect it.
	Check to see if the AC power adapter is damaged. If it is, stop using the air purifier and contact Customer Support (see page 11).
	Plug the air purifier into a different outlet.
	The air purifier may be malfunctioning. Contact Customer Support (see page 11).
Airflow is significantly reduced.	Make sure the filter is removed from its packaging and properly in place (see Getting Started , page 5).
	Press the Control Button to increase fan speed.
	Leave 15 inches / 38 cm of clearance on all sides of the air purifier.
	The pre-filter may be clogged by large particles, such as hair or lint, blocking airflow. Clean the pre-filter (see page 7).
	Replace the filter (see Replacing the Filter , page 8).
Air purifier makes an unusual noise while the fan is on.	Make sure the filter is properly in place with plastic packaging removed (see page 5).
	Make sure the air purifier is operating on a hard, flat, level surface.
	Replace the filter (see Replacing the Filter , page 8).
	The air purifier may be damaged, or a foreign object may be inside. Stop using the air purifier and contact Customer Support (see page 11). Do not try to repair the air purifier.
Poor air purification quality.	Press the Control Button to increase fan speed.
	Make sure no objects are blocking the sides or top of the air purifier (inlets or outlet).
	Make sure the filter is removed from its packaging and properly in place (see page 5).
	Close doors and windows while using the air purifier.
	If the room is larger than 169 ft ² / 16 m ² , air purification will take longer.
	Replace the filter (see Replacing the Filter , page 8).

TROUBLESHOOTING (CONT.)

Problem	Possible Solution
Strange smell coming from the air purifier.	Clean the filter and aroma pad or replace if necessary.
	Contact Customer Support (see page 11).
	Avoid using your air purifier in an area with high humidity.
The Check Filter Indicator light is still on after replacing the filters.	Reset the Check Filter Indicator (see page 7).
 has not turned on after 4–6 months	 is a reminder for you to check the filter and will light up based on how much the air purifier has been used (see page 7). If you don't use your air purifier often,  will take longer to turn on.
 turned on before 4 months	 is a reminder for you to check the filter and will light up based on how much the air purifier has been used (see page 7). If you run your air purifier frequently,  will turn on sooner.

If your problem is not listed, please contact **Customer Support** (see page 11).

FEDERAL COMMUNICATION COMMISSION INTERFERENCE STATEMENT – PART 15

This device complies with Part 15 of the FCC Rules. Operation is subject to the following two conditions:

1. This device may not cause harmful interference, and
2. This device must accept any interference received, including interference that may cause undesired operation.

NOTE: This equipment has been tested and found to comply with the limits for a Class B digital device, pursuant to Part 15 of the FCC Rules. These limits are designed to provide reasonable protection against harmful interference in a residential installation. This equipment generates, uses and can radiate radio frequency energy and, if not installed and used in accordance with the instructions, may cause harmful interference to radio communications. However, there is no guarantee that interference will not occur in a particular installation. If this equipment does cause harmful interference to radio or television reception, which can be determined by turning the equipment off and on, the user is encouraged to try to correct the interference by one or more of the following measures:

- Reorient or relocate the receiving antenna.
- Increase the separation between the equipment and receiver.
- Connect the equipment into an outlet on a circuit different from that to which the receiver is connected.
- Consult the dealer or an experienced radio/TV technician for help.

FCC Caution: Any changes or modifications not expressly approved by the party responsible for compliance could void the user's authority to operate this equipment.

WARRANTY INFORMATION

Product Name	Levoit Core® Mini True HEPA Air Purifier
Models	LAP-C161-WUS, LAP-C161-KUS
<i>For your own reference, we strongly recommend that you record your order ID and date of purchase.</i>	
Date of Purchase	
Order ID	

Terms & Policy

Arovast Corporation ("Arovast") warrants this product to the original purchaser to be free from defects in material and workmanship, under normal use and conditions, for a period of 2 years from the date of original purchase.

Arovast agrees, at our option during the warranty period, to repair any defect in material or workmanship or furnish an equal product in exchange without charge, subject to verification of the defect or malfunction and proof of the date of purchase.

There is no other express warranty. This warranty does not apply:

- If the product has been modified from its original condition;
- If the product has not been used in accordance with directions and instructions in the user manual;
- To damages or defects caused by accident, abuse, misuse or improper or inadequate maintenance;
- To damages or defects caused by service or repair of the product performed by an unauthorized service provider or by anyone other than Arovast;
- To damages or defects occurring during commercial use, rental use, or any use for which the product is not intended;
- To damages or defects exceeding the cost of the product.

Arovast will not be liable for indirect, incidental, or consequential damages in connection with the use of the product covered by this warranty.

This warranty extends only to the original consumer purchaser of the product and is not transferable to any subsequent owner of the product regardless of whether the product is transferred during the specified term of the warranty.

This warranty does not extend to products purchased from unauthorized sellers. Arovast's warranty extends only to products purchased from authorized sellers that are subject to Arovast's quality controls and have agreed to follow its quality controls.

All implied warranties are limited to the period of this limited warranty.

This warranty gives you specific legal rights and you may also have other rights which vary from state to state. Some states do not allow the exclusion or limitation of incidental or consequential damages, so the above limitation or exclusion may not apply to you.

If you discover that your product is defective within the specified warranty period, please contact Customer Support via support@levoit.com. **DO NOT** dispose of your product before contacting us. Once our Customer Support Team has approved your request, please return the product with a copy of the invoice and order ID.

Every Levoit product automatically includes a 2-year warranty. To make the customer support process quick and easy, register your product online at www.levoit.com/warranty.

This warranty is made by:

Arovast Corporation
1202 N. Miller St., Suite A
Anaheim, CA 92806

CUSTOMER SUPPORT

If you have any questions or concerns about your new product, please contact our helpful Customer Support Team.

Distributed by Arovast Corporation

1202 N. Miller St., Suite A
Anaheim, CA 92806

Email: support@levoit.com

Toll-Free: (888) 726-8520

Support Hours

Mon–Fri, 9:00 am–5:00 pm PST/PDT

*Please have your order invoice and order ID ready before contacting Customer Support.



The energy efficiency of this ENERGY STAR certified model is measured based on a ratio between the model's CADR for Smoke and the electrical energy it consumes, or CADR/Watt.

lėvoit®



/LEVOITLIFESTYLE



/LEVOITLIFESTYLE



/LEVOITLIFESTYLE



/LEVOIT



/LEVOIT



LEVOIT.COM