

Smart Toilet Installation Guide

Intelligent toilet manual precautions for use

Content

Before Using

Safety Instructions.....	01
Precautions for Use.....	05
Parts Identification.....	07

Toilet Installation

Installation Guidance.....	09
Installation Steps.....	10
Hose Connection And Installation.....	12
Remote Control Installation.....	13
Trial Run.....	13

Instruction for Use

Side Control Panel Instruction.....	14
LED Display Screen Instruction.....	14
Remote Control Instruction.....	15
Usage Instruction.....	16
Automatic Sensing Function.....	17
Advanced Function.....	18

Appendix



Remote Control Battery Replacement.....	18
Backup Battery Replacement.....	19
Usage Instruction.....	20
Fault Judgement And Solutions.....	21
Daily Maintenance.....	23
Technical Support.....	24
List of Materials.....	25

Safety Instructions



Please read the safety instructions carefully before using.

The precautions listed here are important in relation to safety and should always be strictly observed.

The meaning of the diagram is as follows

 Caution	It means that if this sign is ignored and product handled improperly, the users will dead or be injured seriously.
 Note	It means that if this sign is ignored and product handled improperly, the users will be injured seriously or subject to property loss.

Examples and descriptions of the Diagram

	<ul style="list-style-type: none"> - It means prohibition. - The left diagram indicates "Disassemble prohibited"
	<ul style="list-style-type: none"> - It means that it must be observed. - The left diagram indicates "strictly abide by"

Caution



Do not spray water or detergent on the main body or electronic plug

- May cause fire or electric shock.

No sprinkling

- May cause breakage or damage to the toilet seat or water seepage in the room.

This product belongs to electronic products, please do not install the product in an easily splashed or humid place. Please install an exhaust fan and other exhaust equipment to ensure unobstructed air flow in the bathroom

- Otherwise, it may cause a fire or an electric shock.

Please set the socket for power wiring as follows

- If the wiring is not as follows, it may cause a fire or electric shock.

a. Please use high inductance, fast type leakage switch (rated induction current below 10mA) or protect with insulated transformer (above 1.5KVA, below 3KVA) for the circuit of socket.

b. The installation position of the socket must be more than 0.3m from the ground and as far away from the bathtub as possible.

The grounded wire equipped with the product must be grounded, please be sure to connect to the ground wire

- Otherwise, it may cause an electric shock.

Note: The grounding treatment mentioned here means that the grounding resistance is below 4Ω protective earthing, and the grounding wire uses copper wire of 1.6 mm or more in diameter.

When using in the bathroom

Please make sure power supply and the plug is sealed with silicone to prevent the water

- Otherwise, it may cause a fire or electric shock.

Caution



Do not use in humid places

Do not install this product in humid places such as bathroom

- May cause a fire or electric shock.



Disassemble prohibited

Never disassemble or repair or modify by yourself

- May cause a fire or electric shock.



Prohibition

Malfunctioning products are forbidden to use

- Under the following circumstances, please unplug the power supply and close the water valve to stop supplying water.

Fault refers to:

- The main body or water pipe leaks water.
- The product is cracked or damaged.
- There is abnormal noise or peculiar smell.
- The product smokes and abnormally hot.
- Toilet blockage.

- Fault products are forbidden to use, otherwise, it may cause a fire or electric shock and even indoor water seepage, etc.



Prohibit the touch with wet hands

It is forbidden to plug or unplug the power supply with wet hands

- May cause an electric shock.



Prohibition

Do not damage the power cord and toilet connection line

It is forbidden to pull, modify, heat, twist, place heavy objects on the power cord and toilet connection line.

- Damaged products are forbidden to use, otherwise, it may cause a fire or electric shock or short circuit.



Prohibition

Do not use loose or shaking power outlets

- May cause a fire or electric shock.



Prohibition

Do not use the multi-socket socket

- Please do not connect the wire or use the extension cord when using, it may lead to heat and cause a fire and electric shock.



Prohibition

Water except for tap water and potable water is forbidden to use

- May cause skin inflammation.

Caution



Required

Attention to prevent low temperature burns

- Please adjust the seat temperature to normal level when sitting for a long time.
- Please adjust the seat temperature to the normal stage, the wind temperature to the low level, when the following people use "thermal seat" and "warm air drying" functions.

- Children, the elderly, and other users who cannot adjust the appropriate temperature by themselves.
 - People with walking problems such as the sick and disabled.
 - Sleepy people who took medicines, sleeping pills, cold medicines, etc., with sleepy side effects, drank too much, got overtired, etc.

Caution



Do not keep cigarettes and other burning stuff nearby

- May lead to a fire.



**It is forbidden to put your fingers or sundries at the warm air outlet
It is forbidden to touch the warm air outlet with hands or cover it with cloth**

- Prohibition
- May cause burns, electric shock, fire.
 - Please be careful when children and the elderly using.



Do not apply force, stand on the seat ring, the flip lid or the main body, and heavy objects are forbidden placed on it

- Prohibition
- May cause product to crack, the main body to fall apart, the person to be injured.
 - Toilet may be damaged and indoor water seepage will occur.



Use diluted kitchen detergent (neutral) to clean. Avoid these products:

(toilet cleaner, detergent, petrol, banana water, cleaning powder and nylon brushes, etc.)

- Prohibition
- May damage and crack the plastic, deforming and cracking it and causing personal injury.
 - May damage water pipes and cause water leakage.



When opening the water inlet angle valve, do not remove, or rotate, open the water filter net

- Prohibition
- May cause water leakage.



Do not bend or damage the water filter screen

- Prohibition
- May cause water leakage.



Do not flush any sundries except excrement and toilet paper

- Prohibition
- May cause the water closet to be blocked and the sewage will leak out of the room.

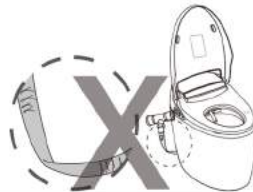

Disconnect the power plug for a long time of not using.

Required



Close the water angle valve to stop supplying water when water leaking

Required



Prevent damage caused by freezing

- Required
- May cause damage to the water inlet configuration and the interior body, and leakage may occurs.



Tighten the water filter net when installing

- Required
- Otherwise, it may cause water leakage.

Please implement warming, to raise the rest room temperature



Make sure the power plug in

Required

- Ensure the power plug is plugged in before using, and the plug and socket fit closely without looseness or incomplete insertion
- Otherwise, it may cause a fire due to heat.
- Disconnect the power plug for a long time of not using.



When the toilet is blocked, unplug it and use a commercially available pipe unblocker to remove the blockage

Required

- Otherwise, it may lead to sewage leakage and indoor water seepage when automatically cleaning.



Do not install it in a place directly exposed to light

Required

- May cause discoloration, aging, and deformation.



Precautions for Use

Cleaning Mistakes

Do not wipe the main body with hard and coarse cloth or tools to avoid scratching.



No coarse cloth



Avoid directly washing with water



Daily Maintenance

Avoid splashing urine on the main body or spray nozzle.

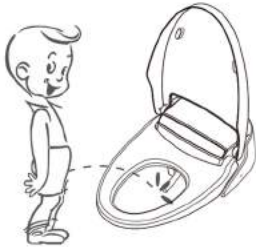

Pull out the power plug during the thunder storms.

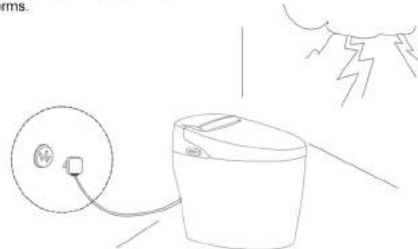

Improper Operation

Shall not cover the seat sensor, human infrared sensor, and the transmitting signal and receiving signal of the remote control.

- May cause the smart toilet misoperation.

Keep away from the main body when using the radio, etc.

- The radio may be garbled.

Do Not Lean Back On The Flip Lid

- May cause crack.

Put Away The Child's Seat Placed On The Seat After Using

- May cause some functions unavailable.

Precautions for Use

Take anti-freeze measures to prevent freezing damage during the freezing night in winter.

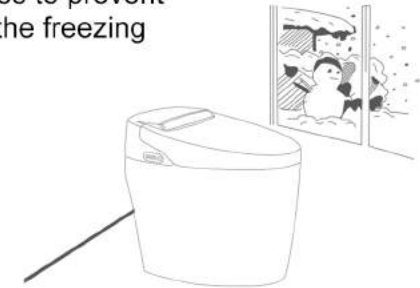

Do not put heaters near the main body.

- May cause discoloration or malfunction.

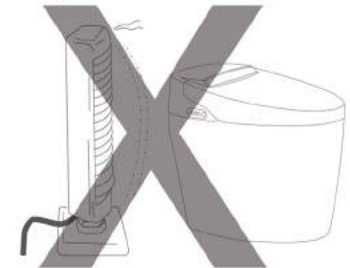

Do not roughly open the seat ring or flip lid

- May cause crack or malfunction.

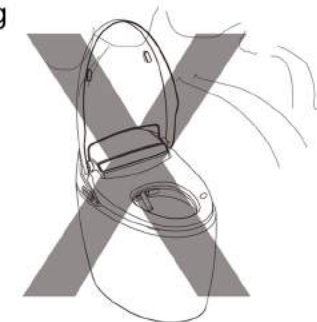

Parts Identification

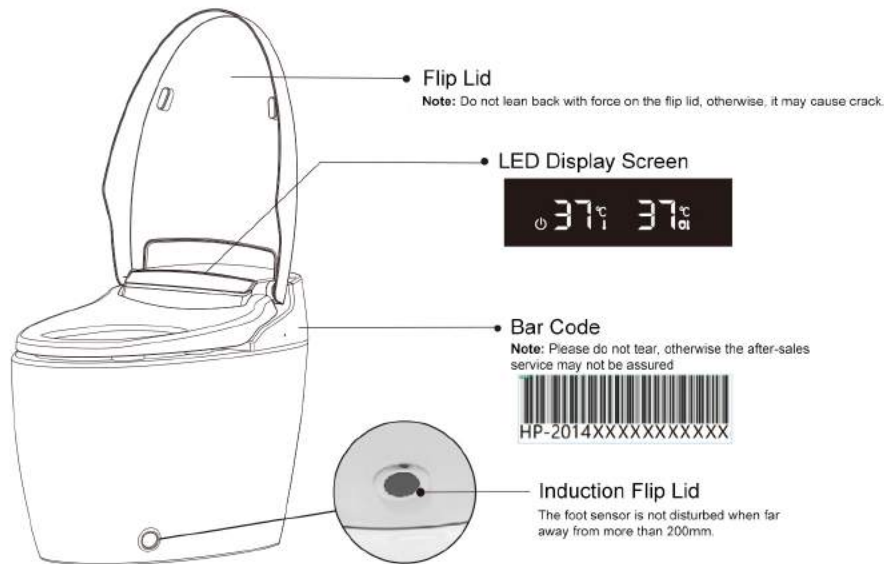
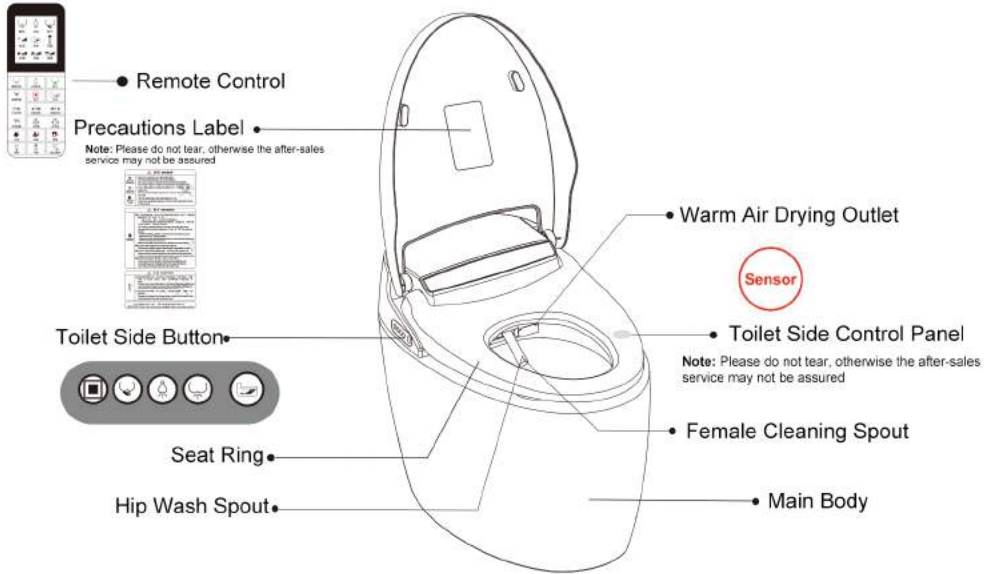

Main Functions

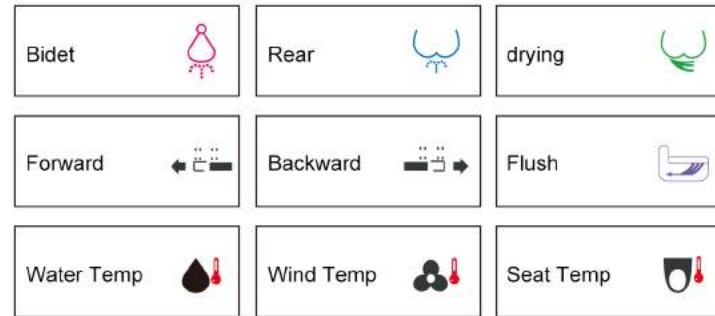

Humanized Functions

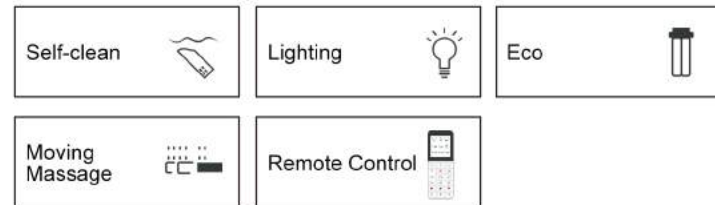

Humanized Functions



Installation Guidance

List of Materials

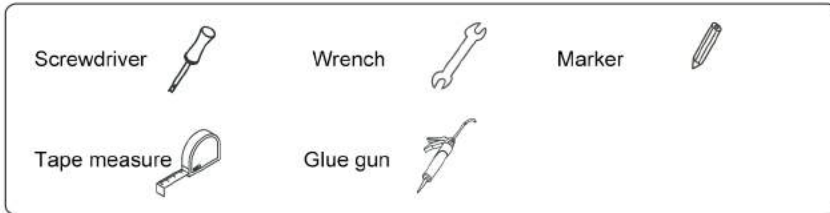

Installation drawings

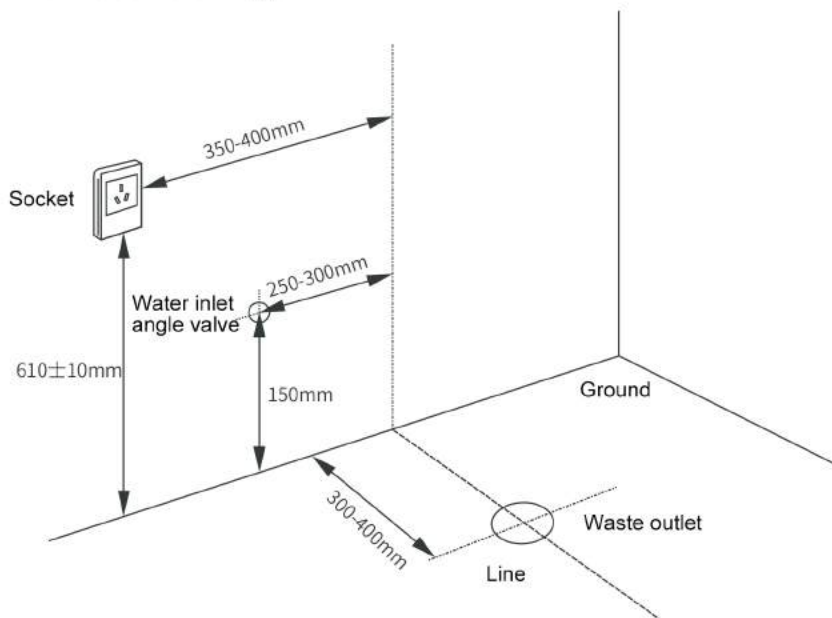

Caution

Please set the socket as follows

- 1.Ensure the socket properly grounded.
- 2.The power cord length is 15m and be located close to the socket, convenient to install and remove, and as far away from the bathtub as possible.
- 3.Use waterproof socket and don't use extension power cord to connect.
- May cause a fire or electric shock.

Size Drawings

unit: mm

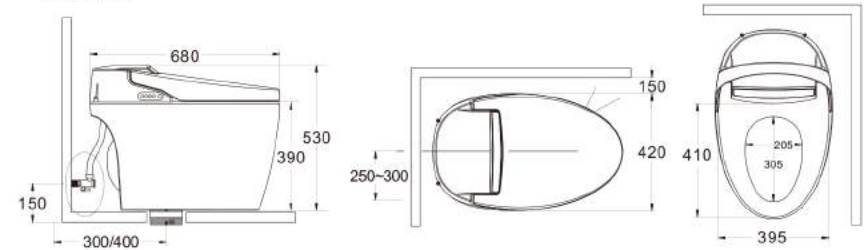

Notice before installation

1. Test water pressure: more than 1.32 gallons within 15 seconds.
2. Before installation, turn on the water pipe for 2 minutes and then connect to the inlet pipe.

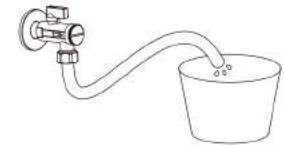

Installation Steps

- 1.For the bathroom newly installing a toilet , a flange with bolt shall be added.

Note: You need to purchase your own flange according to the size and position of the two bolt holes at the bottom of the ceramic.
See Figure 1

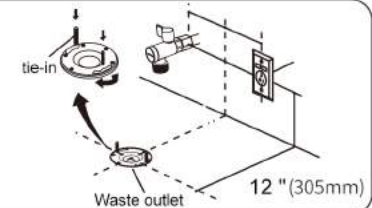
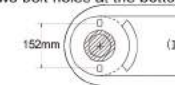

- 2.Lift the flip lid assembly from the toilet, up from the inside.

Note: Do not pull the lid roughly when lifting the toilet flip lid

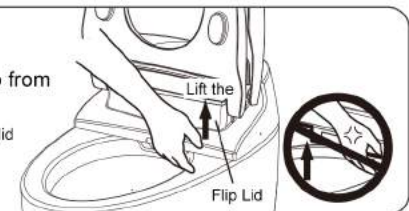

- 3.Install a flange under the toilet.

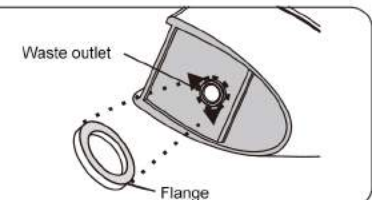

4. Attach the toilet to the flange, making sure the bolts line up with the holes in the toilet.
(from the top)



5. Use a wrench to lock the nut and other accessories to the retaining bolts.
(from the top)

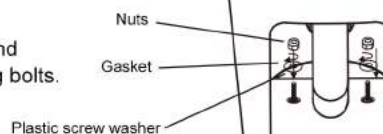

6. To install seat ring and toilet main body: the seat ring positioning hole shall be aligned with the ceramic body positioning column. Then in the seat ring's horizontal state, the hands pressure the back part of the seat ring, so that it can be completely installed.



7. Install the water inlet angle valve and connect the dedicated hose (before connecting the dedicated hose, please discharge water in the hose for 3-5 minutes, ensuring it is clean and that the water inlet angle valve is not blocked)

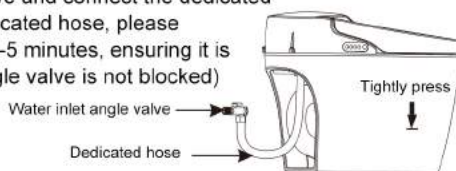

8. Apply the anti-mold sealant at the contact between the toilet and the ground. After the sealant has solidified, plug in the power supply, slowly open the water inlet angle valve. Adjust the water pressure to within 7.5 kg, and check the sealing of the connection points.

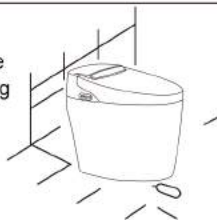

Note

- Smart toilet accessories have been commissioned, personal disassembly is strictly prohibited. Please use the fittings and hoses provided by our company. Old fittings and hoses cannot be reused. If have any questions, please contact local retailers or our after-sales service department.
- All contents of this instruction manual are based on the latest conditions at the time of printing. We reserve the right to make changes without further notice.

Hose Connection And Installation

- Install the new water inlet angle valve, connect the dedicated hose - end to the angle valve, and the other end to the filter housing.
- Plug in the power supply, adjust the angle valve to control the water pressure within 7.5kg.

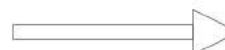

Remove the old water inlet angle valve and replace it with the new one

old water inlet angle valve

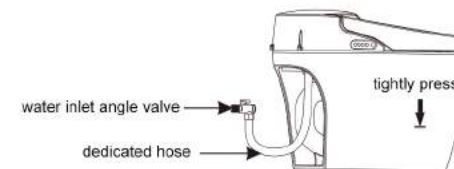

new water inlet angle valve

Note: The hose shall not be folded, otherwise it may cause the water pressure too low to operate the toilet.

Note:

- In case of power failure during the cleaning process, please close the angle valve and stop the water supply. The function can be normal after the self-test when the power comes in.
- Installation shall use the new hose assembly that comes with the apparatus and other parts specified in the apparatus. The old hose assembly cannot be reused, otherwise it may cause water leakage.

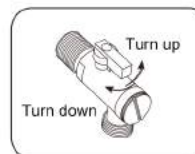

Adjust the angle valve

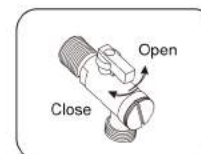

Turn off the angle valve

Remote Control Installation

Installation Method

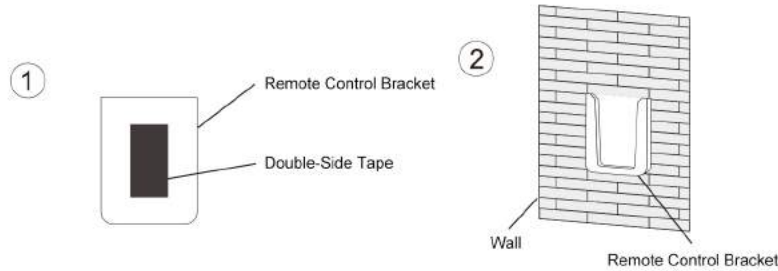

Note:

1. Clean the installation area before taping. Press the tape firmly and evenly when applying. Can be used after 15 minutes.
2. Double-side tape is suitable for tile-type flat walls, not for wallpaper-type walls.

Trial Run

First time connect water and power supply:

Open the water supply angle valve to turn on the power, when soft lighting and display on the water temperature flash, it means the heating water tank is feeding water.
Waiting for about 30 seconds after soft lighting and the water temperature on display stops flashing, it means the heating water tank has been full of water. At this time, try to operate the toilet as follows.

1. Seating Sensor

The picture shown is the seating sensor area. Only when the system senses someone is seated, the function can be on. Then, the buzzer will "beep" once, indicating it has been sensed and the system can be activated. When the human body leaves the sensor place, the buzzer will also "beep" once.



2. Check Fundamental Functions

When the human body sits on the sensor, the buzzer beeps. Press the "Rear" or "Bidet" button on the side control panel to operate.



3. Check the Drying Function

When the human body sits on the sensor, the buzzer beeps. Press the "Drying" button on the side control panel to operate.



Side Control Panel Instruction



Long press this button to turn on/off the entire mode. Short press means "Stop", just used to stop current functions.



Press the "Bidet" button when seated. Press it again to shift to the mobile cleaning mode, repeatedly. Press the stop button or leave the seat to stop this function.



Press this button to start rear cleaning. Press it again to shift to mobile cleaning. Press the stop button or leave the seat to stop this function. Press this button to start nozzle self-cleaning when not seated.



Press this button to start the warm air drying function when seated. Press the stop button and this function will be stopped.



Press the "Bidet" button when seated. Press it again to shift to the mobile cleaning mode, repeatedly. Press the stop button or leave the seat to stop this function.

LED Display Screen Instruction



The top of intellectual toilet, LED display Screen

37°C

indicates water temperature of the nozzle



indicates energy-saving mode, light means on, not light means off

37°C

indicates the temperature of the seat

Remote Control Instruction

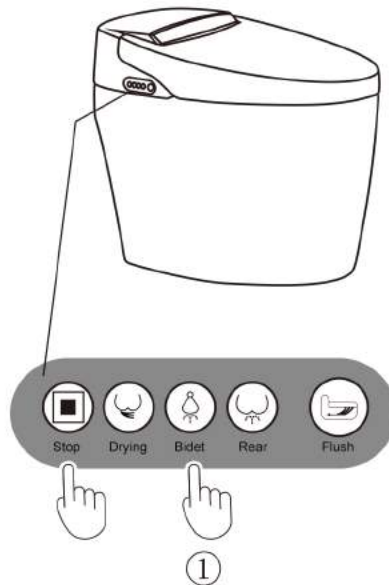
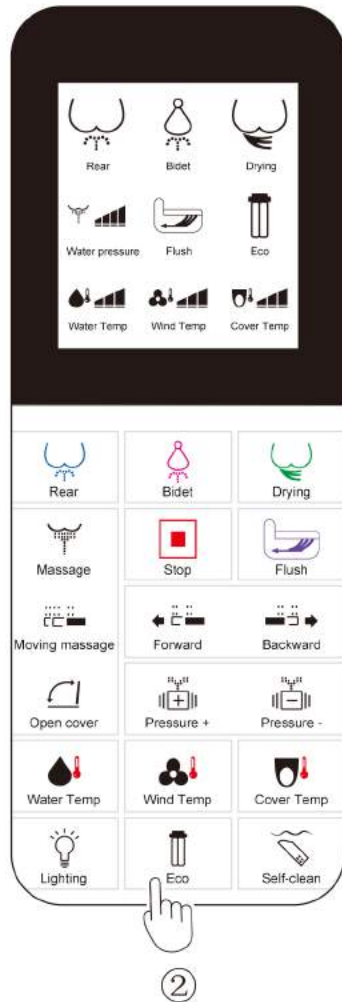

Notice: Remote Control pairing

The remote control pairing method: Long Press the toilet side button["Bidet" + "Stop"] at the same time for 3-5 seconds and it will beep. Press any button on the remote control and then it will beep, which means pairing successfully.

Usage Instruction



Rear

Rear

Press this button to extend the nozzle forward when seated. After the Hip wash spout spraying for 2 minutes, it will stop spraying automatically. It will also stop washing if you press the "Stop" button. If you press the "Rear" button again, the nozzle will move back and forth to enter the mobile cleaning mode. During washing, press the "Pressure +" or "Pressure -" button on the remote control to adjust the water pressure. The function will stop this when the human body leaves the seat.



Bidet

Bidet

Press this button to extend the nozzle forward when seated. After the Female cleaning spout spraying for 2 minutes, it will stop spraying automatically. It will also stop washing if you press the "Stop" button. Press this button again while operating, the nozzle will move back and forth to enter the mobile cleaning mode. During washing, press the "Pressure +" or "Pressure -" button on the remote control to adjust the water pressure. The function will stop when the human body leaves the seat.



Drying

Drying

Press this button to start the warm air drying function when seated. It will stop drying automatically after drying for 3 minutes. It will also stop drying if you press the "Stop" button. During drying, press the 4 stages "normal/low/medium/high" to adjust the wind temperature. The function will stop when the human body leaves the seat.



Massage

Massage

The water pressure can be changed in 5 stages alternately and rhythmically.



Stop

Stop

Press this button to stop current operating function. After the user leaves the seat, the toilet will stop and flush automatically.



Flush

Flush

Short press this button to flush.



Moving massage

Moving Massage

The nozzle can move back and forth in the current position to expand the cleaning area.



Forward

Forward

During washing, press this button to move the nozzle forward, which is divided in 5 stages.



Backward

Backward

During washing, press this button to move the nozzle backward. The nozzle can be adjusted in 5 stages.



Open cover

Open Cover

Press this button when not seated. If no other operation is performed after opening the flip lid/seat ring, 1.5 minutes later, the flip lid/ seat ring will be automatically closed.



Pressure +

Pressure +

During the rear cleaning or bidet cleaning function, press this button to add more water, which is divided into 5 stages.



Pressure -

Pressure -

During the rear cleaning or bidet cleaning function, press this button to decrease the water, which is divided into 5 stages.

Usage Method



Water temperature

Water Temperature

Short press this button continuously, which is divided into 4 cycle stages: normal(no heating), low(about 33°C), medium(about 36°C), high(about 40°C).



Wind temperature

Wind Temperature

Short press this button continuously, which is divided into 4 cycle stages: normal(no heating), low(about 35°C), medium(about 45°C), high(about 55°C).



Cover temperature

Cover Temperature

Short press this button continuously, which is divided into 4 cycle stages: normal, low(about 34°C), medium(about 37°C), high(about 40°C).



Lighting

Lighting

Press this button to light on/off.



Eco

Eco

Short press this button to turn on/off. In the "Eco" mode, when the non-working toilet is on standby state, the seat heating will be off after 48 hours automatically. Otherwise, the seat heating will not be off after 48 hours. (Default is the "Eco" function on).



Self-clean

Self-Clean

Only when the human body leaves the seat, press this button to start this operation. The nozzle extends to the maximum and the self-cleaning spout continues for 15 seconds spraying. This function can be stopped if you press the "stop" button.

Automatic Sensing Function



Foot sensing

Foot Sensing

If the foot gets close to the sensing area for the first time, the flip lid will be opened automatically. For the second time, the seat ring will be opened. For the third time, the seat ring will be closed and the flip lid can only be closed by remote control instead of the "foot sensing" function. If the seat ring is opened and no other operation is performed, the seat ring will be automatically closed after 1.5 minutes.

Advanced Function



Off-seat flushing

Off-Seat Flushing

Long press the "massage" button on the remote control to start the off-seat flushing function. Beeping for once means turning on this function. Beeping for 3 times means turning off this function.



On/off

On/Off

Long press the "stop" button on the side panel control of the toilet.



Note: The drying and cleaning functions cannot be used in the off-seat state.

Remote Control Battery Replacement

When the battery runs out, the remote control maybe insensitive or out of control occasionally. Please replace the alkaline batteries immediately.



Note

The polarity of battery must be put in the right position and the compression spring extends from the negative pole.

- New and old batteries should not be mixed.
- Please use alkaline batteries.

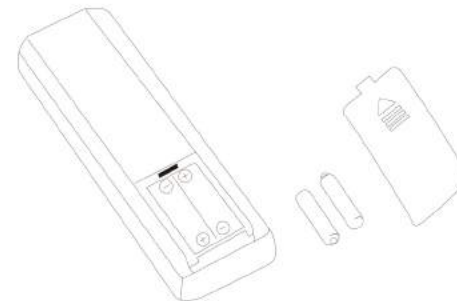

Note: Remote control with batteries. Please appropriately store it in a location that is out of reach of young children.

Backup Battery Replacement

Steps

1. Unplug the power outlet.
2. Lift the toilet flip lid.
3. Open the battery cover.
4. Put the battery in the right position.
5. Press the "flush" button to ensure appropriate flushing.
6. Close the battery cover. Put the flip lid back and fix it.

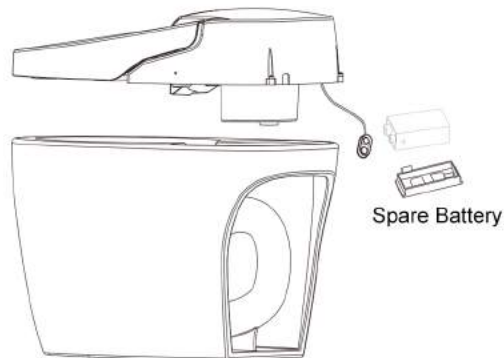

Note

1. The backup battery must be the 9V alkaline batteries. Do not use carbon or other batteries.
2. If the battery is low or not installed, it will cause an abnormal flush. And the flush function will be abnormal even if the power is off.
3. Recommend checking the 9V backup battery and replacing it with a new one every two years.
4. Please replace the old battery and recycle it appropriately.

Usage Instruction

Water Amount And Temperature

Due to the storage water heating mode, the water temperature will not decrease when cleaning for a long time. Although the water temperature may fluctuates, it doesn't effect the normal use.

Cleaning water will be controlled according to original setting temperature.

Normal: spouting water without heat.

Low: about 33°C

Medium: about 36°C

High: about 40°C

Heating time depends on external water inlet temperature.



Installation with the Seat Sensor

When you are not seated and accidentally press the button, the spout will not operate due to the seat sensor. All cleaning functions will not be set when not seated.

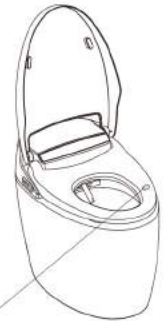

The Seat Sensor

The seat sensor will not work if the following conditions occur:

- ✘ The human body does not sit on the seat ring.

Environment usage instruction:
It is recommended that there should be no obstacle within 1.5m of the toilet, otherwise it will cause the flip lid to make wrong instructions.

Fault Judgement And Maintenance

Fault Judgement And Maintenance

Symptom	Inspection Method	Countermeasure
Does not start at all	Whether there is a power outage or the power outlet is not connected	Please make sure to insert the power plug
		Please unplug and plug in again
No water supply or weak water spouting	Whether water is stopped or the water supply valve is closed	Please check the water source and open the water supply valve
	Whether the water supply filter is blocked	Please clean the filter
	Whether the nozzle is clogged with scale	Please clean the nozzle with a toothbrush
	Whether the water pipe is bent	Please smooth the water pipe
Leak	Whether the water pipe connection part is tightened	Please tighten the water pipe connection
Water temperature/Cool seat	Whether the water temperature and cover temperature are adjusted to normal temperature	Please readjust the temperature
Abnormal flushing /the sewage discharging does not work	Put around 2.1 Gal(8L) water into the toilet to check whether the sewage drainage pipe is blocked	If the sewage in the toilet cannot be discharged quickly after pouring water, the sewage drainage pipe may be blocked. Please clean the drainage pipe.
Remote control cannot display	Low battery power	Please replace the battery with a new one
	Recheck the code	Please refer to page 15 about remote control pairing.

Fault Tip

Fault	Tip
The sensor of cover temperature	The LED display screen shows E7 code

Remote Fault Diagnosis

Operating through the toilet side button, you can check whether the flushing function and the trial run work appropriately. (Start the cleaning and drying function after seated)

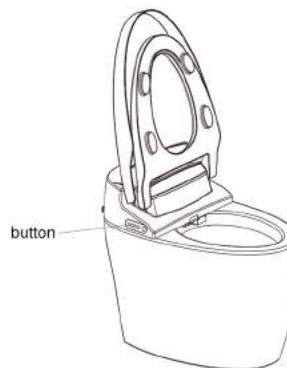

Emergency Fault Judgement

Under no water supply circumstance, put around 2.1 Gal(8L) water into a barrel and flush the bowl of ceramic.

Note: Avoid water spilling from bowl.



When the product is left unused for a long time

- Especially in winter when no one at home for a long time, please drain out the water inside the tank and the pipe to prevent freezing

To Discharge Water

1. Drain out the water inside tank.
- Activate flushing, and then turn off angle valve to prevent water inlet. Drain out the water inside the heating tank and the pipe.
2. Unplug and cut off the electricity.
3. Unscrew the hose connector off angle valve, drain the water in the pipe and reinstall.
4. Handle the remaining water in ceramic body.
It is suggested to put some antifreeze into water inside the ceramic body.

Tips: Make sure to turn on water angle valve and power supply when you use the toilet again.



Note: Before water discharging, the power must be cut off!

Daily Maintenance

Main unit care and maintenance

1. Wipe the surface with a sponge or soft damp cloth or neutral detergent cloth.
2. **Note:** Do not use thinners, light gasoline, detergents, chemicals, etc. to wipe. Do not spray insecticides, aromatics, deodorants, etc.

Note: The material of the product is new plastic material, which is not discolored. Most of the discoloration phenomenon is oxidation reaction. Product contact with perfume, toilet cleaner, nail polish and other liquids, if not wiped off in time will cause product surface oxidation.

Some users may place a seat cushion on the seat ring with a heating function. Generally, the cushion and the contact surface of the seat are non-slip rubber, once heated, it is easy to cause the seat in contact with the location to discolor.

Spray nozzle maintenance and care

1. Please clean the nozzle regularly: Prepare a toothbrush and soft cloth first. While not sitting on the unit, short press the "Rear" Button on the side of the toilet, the spray nozzle will extend outward and water will flow out to clean the nozzle and the spout.
2. Use brush and soft cloth to clean. After cleaning, press the "Stop" button to automatically retract the nozzle.

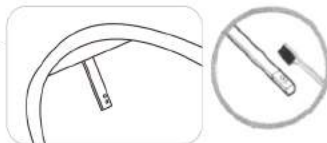

Maintenance of filter net

1. Turn off the water inlet angle valve and use a screwdriver to the left to unscrew the filter net.
2. Remove the filter net and use a brush to clean it. Reinstall the filter net into the water inlet angle valve.
3. Tighten the filter net and then turn on the angle valve.



Remove the filter net



Rinse the filter dirt with water

Empty the heating water tank to storage water

1. Unplug the power inlet.
 2. Turn off the water supply.
 3. Lift the toilet body in the direction of the arrow.
 4. Lift the bottom of the toilet body and remove the drainage screw to discharge all water.
- (Note: do not lose the drainage screw)
5. Reinstall the drainage screw on the toilet and ensure to tighten it.



Gently lift upward

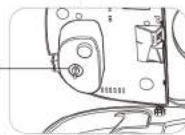

Drainage screw

Remove the drainage screw to discharge water

Technical Support

Name		Smart Toilet	
Power		AC 220V 50/60Hz	
Cleaning Device	Heating Water Tank	0.3L	
	Inlet Water Temperature	1°C-30°C	
	Inlet Water Pressure	0.15-0.75MPa	
	Warm Water Temperature	Adjustment: About 30°C-40°C	
	Spray Water Amount	Rear	About 0.35-1.2L/min (When water pressure is 0.2MPa)
		Bidet (female-specific)	
	Spout Position	Rear	50mm—90mm
		Bidet (female-specific)	
Heating Power		1400W	
Safety Equipment		Flow SensoR, Water temperature sensor, Temperature switch, Thermal fuse	
Rated Power		1300W (inlet water temperature 15°C ±2°C, water pressure 0.2MPa)	
Drying Device	Wind Speed	≥ 4m/s	
	Temperature Adjustment	4 stages (room temperature - about 55°C)	
	Heating Power	250W	
	Safety Equipment	Thermal controller, Thermal fuse	
Seat Heating Device	Temperature Adjustment	4 stages (room temperature - about 40°C)	
	Heating Power	45W	
	Safety Equipment	Thermal controller, Thermal fuse	
	Open And Close Device	Seat ring and flip lid with damping cushioning device	
	Safety Equipment	Leakage protector, The cover temperature sensor	
Power Cord Length		1.5m	

List of Materials

Main Unit



A Smart Toilet



A Set Of Remote Control Components
(include remote control, bracket, double-side
tape, 2 AAA alkaline batteries)



A Flange



A Water Barrier Cap
(Please keep this accessory for functional testing)



An Installation Manual



An Angle Valve
(15/16 inch adapter, 1/2 inch adapter)