

360 Dash Cam G300H

User Manual

Product appearance

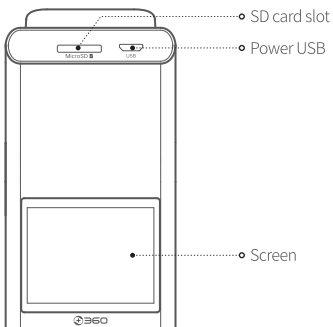
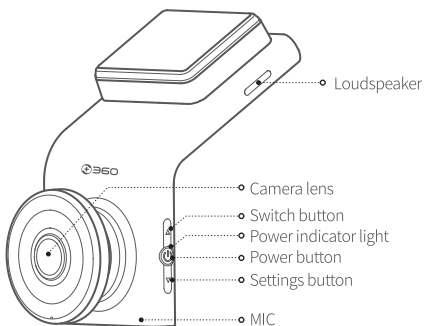

Packing List

Upon opening the package, please check if the dash cam is in good condition and if all accessories are included.

- | | |
|-----------------------------|----------------------|
| 1) Main unit x 1 | 2) USB power cord x1 |
| 3) Electrostatic film x 1 | 4) User manual x1 |
| 5) Installation pry bar x 1 | 6) Car charger x1 |

Installation

1) Install the electrostatic film:

Install the electrostatic film on the front windshield in the recommended area (dashed area) shown in the diagram below. Before installation, please clean the glass and ensure there are no bubbles between the electrostatic film and the glass.

Tip: Please install the dash cam as close to the middle area above the front windshield as possible, in order to ensure full coverage of the car's front view and improve ADAS-assisted driving accuracy.

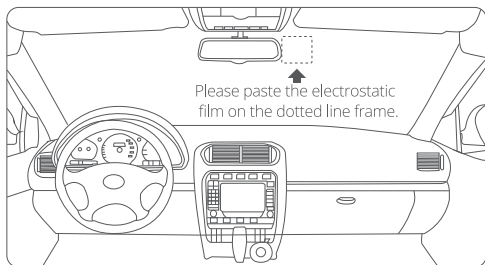

2) Attach the dash cam

Remove the 3M adhesive protective film, attach the dash cam bracket to the electrostatic film, and adjust the dash cam to the appropriate angle.

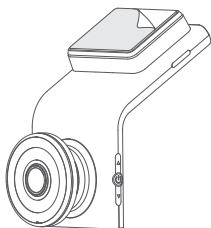

3) Removal and installation of the dash cam:

Slide the dash cam upwards in the direction of the arrow (as indicated in the diagram below) until you hear a "click" sound. This indicates that the dash cam is ready to be taken down. In contrast, align the hole on the back of the dash cam bracket with the snap position on the 3M adhesive, and slide the bracket downwards until you hear a "click" sound, indicating that the dash cam can be installed.

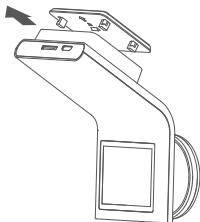

4) Wiring and connecting the power supply

Route the power cord along the top of the front windshield, through the A-pillar, and into the storage compartment located at the front passenger seat, close to the cigarette lighter port, as shown in the diagram below. Then, connect the power cord to the cigarette lighter power supply.

Tip: You can use the included wiring pry bar to bury the power cord under the A-pillar sealant strip. Please note that the position of the cigarette lighter port may vary between different vehicles, and the pictures are for reference only.

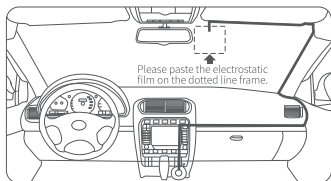

Please paste the electrostatic film on the dotted line frame.

Download and Installation of the App

Method 1: Scan the QR code provided below to download and install the app.
Method 2: Search for "botslab" in major application stores and click Download to install the botslab app.



Scan to download **Botslab** APP

User Guide

Scan the QR code to access the online version of Quick Start Guide, and obtain more detailed instructions on how to use the dash cam.



Precautions for Using the Dash Cam

- This product is an auxiliary device (dash cam) for safe driving.
- Any losses resulting from product malfunctions, data loss or product usage are not the responsibility of our company.
- This product is designed as an auxiliary device to record external images of vehicles. Due to different driving and vehicle environments, some functions may not be supported.
- Firmware upgrades are carried out periodically to improve the product, which may cause changes in product performance, and sometimes may lead to the inability to capture images due to the usage environment. Therefore, the driving images recorded in this product are for reference only.
- Although this product can record and save images of vehicle accidents, it does not guarantee that all accident images can be recorded. A minor collision accident may not activate the collision sensor, so the image may not be recorded in a dedicated folder.
- Do not install or operate this product while the vehicle is in motion.
- This product must be directly connected to the car's power supply system and installed by professionals with installation experience. Do not use this product for a long time without starting the engine.
- This device may interfere with the function of improperly protected medical devices. If you have any questions or are uncertain whether the medical device can shield external RF energy, please seek advice from a doctor or the medical device manufacturer.
- Do not subject this product to strong shocks or vibrations, which may damage the product, resulting in malfunction or inability to use.
- Before cleaning or maintenance, please stop using the product.
- Do not use chemical solvents or cleaning agents to clean this product.
- Do not disassemble or modify this product without authorization.
- The normal temperature range for using this device is between 0 °C and 50 °C.
- Please ensure that you use this product within the limits allowed by law.

Precautions for Battery Use

- Do not disassemble, modify, crush or squeeze the built-in battery by yourself, in order to avoid damaging the battery, generating heat, and causing a fire.
- Do not put this product or battery into a fire or in a high-temperature environment, as this can lead to the battery catching fire or exploding.
- Do not use the battery for other purposes.
- Do not use any damaged chargers or batteries.
- If the battery shows any abnormal signs such as high temperature, deformation, discoloration, bulging, or leakage during use, charging, or storage, please stop using it immediately, and call our after-sales service center to replace a new battery, in order to prevent any potential safety hazards.

Important Statement

Personal Information Security

To ensure the safety of you and your family, please make sure that your product is only bound by authorized persons. 360 will take strict measures to ensure the security of your and your family's information.

Explanation of Hazardous Substance Content Status

Component Name	Hazardous substances and elements					
	Lead (Pb)	Mercury (Hg)	Cadmium (Cd)	Hexavalent chromium (Cr6) (Cr (VI))	Polybrominated biphenyls (PBB)	Polybrominated diphenyl ether (PBDE)
Plastic shell	○	○	○	○	○	○
Circuit board components	×	○	○	○	○	○
Power cord	×	○	○	○	○	○
Camera lens	○	○	○	○	○	○

This form is prepared in accordance with SJ/T11364.

○ : It indicates that the hazardous substance in all homogeneous materials of this part is below the limit specified by GB/T26572.

×



: It indicates that the hazardous substance in at least one homogeneous material of this part exceeds the limit specified by GB/T26572. However, it satisfies the limit requirements specified in the List of Exempt Applications of Hazardous Substances Identified in the Management Catalog.

Remarks: The lead content in a small number of special-purpose SMT electronic components (such as high-voltage resistors, ceramic resistors, diodes, etc.) in the part labeled "×" in the above table may be $\geq 0.1\%$. The lead content in screws or cores of data cables can be $\geq 0.1\%$ due to the adoption of high-performance alloy. These components are in compliance with exemption clauses of the EU RoHS Directive. At this stage, due to the limitations of the global technological development level, there is no alternative technologies and parts, and the lead content of the external contactable parts of the product meets the environmental protection requirements.

Note: Some electronic components are marked "X" in the table, (such as high voltage resistors, ceramic resistors, and diodes) . Their quantity of Pb may exceed 0.1% due to high-performance consideration. As the core in the screws and in the data cable is made of high-quality alloy, Pb may also exceed 0.1%.All of these items comply with the exemption conditions of EU's RoHS directive, and no alternative technologies or components can be applied at present.

Attentions And After-Sales Service

I. Introduction and declaration of after-sales service

- Thank you for choosing the 360 dash cam. Please use only the accessories provided by the original manufacturer to avoid unexpected malfunctions or damage. Failure to use the product as outlined here, or connecting it with incompatible accessories, will result in your warranty becoming void. The company assumes no responsibility for any danger or damage caused by such unauthorized uses. If you dismantle or change the product housing, the warranty will also become invalid.
- Our company is committed to constant improvement and sustainable development. As a result, we may modify and improve the product manual without advance notice to users.
- Unless otherwise specified by applicable laws, the manual contents are provided based on the product's manufacturing conditions. Therefore, no explicit or tacit warranty of any kind is made for the correctness, reliability, or contents of the files.
- The product manual is protected by copyright law. Copying, transmitting, distributing, or using it in other forms is forbidden without the written approval of 360.

II. In regards to service policies within the warranty period of the 360 dash cam:

1. This product contains a one-year warranty. For details on warranty service, kindly contact local authorized distributors.
2. The warranty period for the power adapter and charger cable is 12 months, and for the battery, it is 6 months.
3. Non-electronic accessories are not covered by the warranty.

List of Performance Faults of 360 Dash Cam

Name	Performance fault
Mainframe of 360 dash cam	Failure of functions listed in the product manual; No display or incorrect characters displayed on the screen; Failure during start-up or normal recording of image data; Button control failure; Cracks in the housing caused by structural or material issues.
Charger & charger cable	Abnormal status or operation, or failure to charge properly with the designated charger.

III. Charged maintenance policies of 360 recorder product

If any of the following cases occur, the 360 Company or its authorized service centers will provide reasonable maintenance services at a cost for those outside the scope of the warranty.

1. Exceeding the valid warranty period.
2. Lack of warranty certificate or valid invoice. The warranty certificate does not match the model and labeling of the product, or has been tampered with.
3. Damage caused by usage, repair, and maintenance that does not follow the requirements in the User Manual. Damage or malfunction resulting from personal removal, maintenance, or modification of the system software without authorization from the 360 Company.
4. Collision, soaking, breaking or burning of the printed circuit board.
5. Cracking or damage to the outer shell, LCD screen, antenna, etc. of the 360 dash cam during use, except for that caused by structural or material factors.
6. Damage due to force majeure.

Contact Us

Website: <https://www.botslab.com>

Email: service@botslab.com

Facebook: @botslabofficial

RF Exposure

CE:

EU regulatory conformance: :

RF exposure information: The Maximum Permissible Exposure (MPE) level has been calculated based on a distance of 20cm between the device and the human body. To comply with RF exposure requirements, it is recommended to use the product while maintaining a distance of 20cm between the device and the human body.

CE DOC

Hereby, Botslab Inc. declares that theradio equipment type G300H is in compliance with Directive 2014/53/EU.Thefull text of the Eu declaration of conformity is available at the following internet.

address: <https://www.botslab.com>

Manufacturer information:

Company name: Botslab Inc.

Address: 919 North Market Street, Suite 950, Wilmington, New Castle, Delaware, USA

Operation temperature: -20~60 C

Battery charging temperature: 10-45 C

Operation frequency(Max power)

Wifi:2412MHz-2472MHz(18dBm)

Warranty Card

1) User Information

Name _____ Tel _____

E-mail _____ Post Code _____

Address _____

2) Product Information

Color _____

SN _____

3) Repair Record

Service Record	Fault information	Service date	Signature



EC	REP
-----------	------------

Prolinx GmbH
Brehmstr. 56, 40239 Duesseldorf , Germany
Tel: 0049 211 3105 4698
Email: eu@eulinx.eu

UK	REP
-----------	------------

Prolinx Global LTD
27 Old Gloucester Street London, WC1N3AX, UK
Tel: 0044 203 966 1193
E-mail: eu@eulinx.eu