

# UGREEN

## 17-in-1 Thunderbolt™ 5 Docking Station User Manual

Model: U716

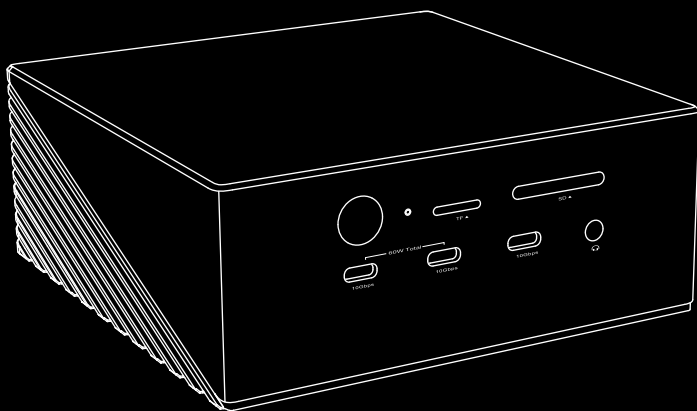

# CONTENTS

## Package Contents

### 1 Product Overview

1.1 Interface Layout

### 2 Video Output Modes

2.1 For Windows OS

2.2 For macOS

### 3 Video Resolution and Refresh Rates

3.1 High-Resolution Settings

3.2 High-Refresh Rate Settings

### 4 Using the Product

4.1 M.2 Installation

### 5 Specifications & Safety Warnings

5.1 Specifications

5.2 Safety Warnings

### 6 Troubleshooting

6.1 Cannot Connect to the Laptop or Stops Working Intermittently

6.2 Cannot Connect to a Monitor or Dual/Triple Monitors

6.3 Ethernet Port does not Support 2.5Gbps Internet Speed

6.4 USB-A or USB-C port Stops Working or Functions Intermittently

6.5 SD Port or Micro SD Port is not Working

6.6 Audio Port is not Working

### 7 FAQ

7.1 Compatibility Related

7.2 Display Related

7.3 Charging Related

7.4 Safety Related

### 8 Technical Support

# Package Contents

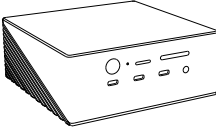

1× 17-in-1 Thunderbolt™ 5 Docking Station

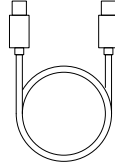

1× Thunderbolt™ 5 Cable (Connecting to host)

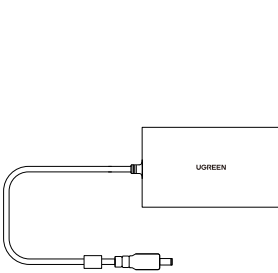

1× Charger



AC Power Cable with US Plug  
(Also Works for Regions in Canada)



AC Power Cable with EU Plug

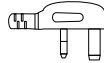

AC Power Cable with UK Plug

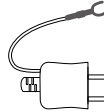

AC Power Cable with JP Plug

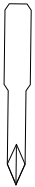

Screwdriver



Screw  
(Pre-installed in the Docking Station's SSD Bay)



1× Silicone Pad  
(For Thermal Conduction)







## Note:

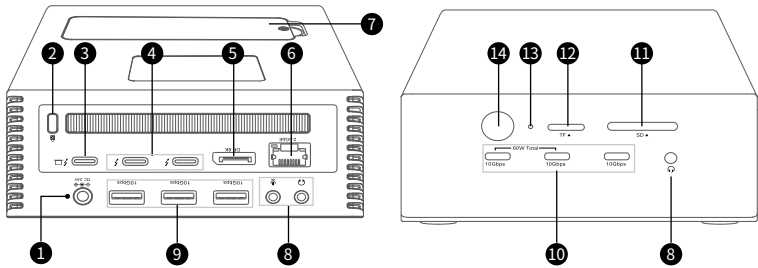



1. The Power Supply Cord Must vary due to different countries.
2. 同梱される AC 電源ケーブルは同該電気用品の専用ケーブルであるので、他の電気用品に使えません

# 1 Product Overview

## 1.1 Interface Layout



No.	Port	Description
1	 DC Input	Connect to the provided power adapter.
2	 Security Lock	Prevents the device from being stolen or moved without authorization.
3	 Thunderbolt 5 Upstream Port (with computer icon)	<ul style="list-style-type: none"> <li>Connect your laptop using the provided Thunderbolt 5 cable.</li> <li>Provides charging for your laptop at up to 140W PD Max.</li> </ul>
4	 Thunderbolt 5 Downstream Port	<p>Connect external hard drives or monitors that support Thunderbolt / USB-C DP Alt Mode, with a maximum resolution of up to 8K.</p> <p><b>Note:</b> To achieve maximum resolution, the connected device must support 8K.</p> <ul style="list-style-type: none"> <li>Charge your devices at up to 15W.</li> <li>Support data transfer via Thunderbolt 5 / 4 (over USB-C) and USB-C ports for USB 3 / USB 4.</li> <li>Support video streaming via Thunderbolt 5 / 4 (over USB-C) and USB-C DP Alt Mode.</li> </ul>
5	 Display Port (DP) Port	<p>Connect to DP monitor, with a maximum resolution of up to 8K.</p> <p><b>Note:</b></p> <ul style="list-style-type: none"> <li>Display output performance is limited by the capabilities of both the host device and the connected monitor's specifications. Refer to the Video Resolution and Refresh Rate table for details.</li> </ul>
6	 Ethernet Port	<p>Connect to an Ethernet network with a speed of up to 2.5Gbps.</p> <p><b>Note:</b></p> <ul style="list-style-type: none"> <li>Actual internet speed depends on the service speed provided by your internet service provider (ISP).</li> <li>During the process of high-speed data transmission via data ports, the actual internet speed may decrease.</li> </ul>
7	NMVe M.2	<ul style="list-style-type: none"> <li>Supports M.2 NVMe SSD sized 2230/2242/2260/2280</li> <li>Compatible with M-Key/B+M Key</li> </ul>
8	Audio Jack × 3	<ul style="list-style-type: none"> <li>3.5mm Input/Output icon: Available for mics/earphones/speaker</li> <li>3.5mm Input icon: Available for mics</li> <li>3.5mm Output icon: Available for earphones/speakers</li> </ul>

9	 × 3 USB-A 3.2 Port	Each port provides a data transfer speed of up to 10Gbps.
10	 × 3 USB-C 3.2 Port	Each port provides a data transfer speed of up to 10Gbps. Two ports support up to PD 60W Max charging in total.
11	 SD Card Reader	<ul style="list-style-type: none"> <li>• Insert compatible SD/TF cards (Dual-Slot Concurrent Access).</li> <li>• Provides data transfer speeds of up to 312MB/s, compatible with SD 4.0 / 3.0, UHS-II / UHS-I, SDXC, SDHC, SD, MMC, RS-MMC, Micro SDXC, Micro SD, and Micro SDH.</li> </ul>
12	 TF Card Reader	
13	Indicator	<ul style="list-style-type: none"> <li>• Green Light On: The docking station is normally powered but not connected to any host device.</li> <li>• Blue Light On: The docking station is successfully connected to a host device.</li> <li>• Light Off: The docking station is powered off (no power supply).</li> <li>• Green Light Flashing: Indicates abnormal power supply (e.g., unstable voltage or connection).</li> <li>• Blue Light Flashing: Signifies a CC protocol communication failure, typically caused by compatibility issues with connected devices.</li> </ul>
14	Power Button	Press once to power on/off.

## 1.2 Input & Output Specifications

No.	Type	Port	Description
1	Input	DC Input	24V 10 A, 240W
2	Output	Thunderbolt 5 Upstream Port	5.0V 3.0A, 15.0W / 9.0V 3.0A, 27.0W / 15.0V 3.0A, 45.0W / 20.0V 4.8A, 96.0W / 28.0V 5.0A, 140.0W (140.0W Max)
		Thunderbolt 5 Downstream Port	5.0V 3.0A, 15.0W (15.0W Max)
		USB-A Port	5.0V 0.9A, 4.5W (4.5W Max)
		USB-C Port	It has two USB-C ports that support PD 60W for peripheral charging, and the 60W power is shared between them. i. Single-port use: 5V/9V/15V/20V 3A ii. Dual-port use: 5V/9V/15V 2A

## 2 Video Output Modes

**!** **Note:** The images below are for reference only. You can customize the settings on the laptop for different output modes.

### 2.1 For Windows OS

#### 1. Via Thunderbolt 5 laptops

##### Duplicate Mode

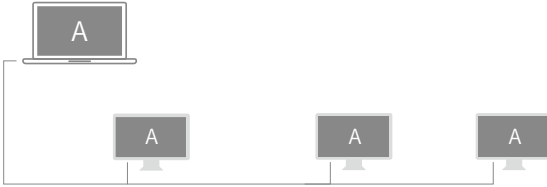

##### Extend Mode

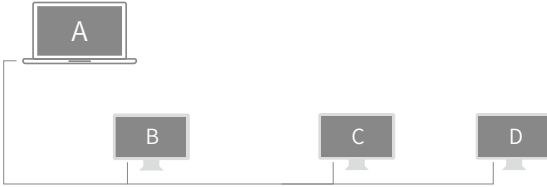

#### 2. Via Thunderbolt 4 & USB 4 laptops

##### Duplicate Mode

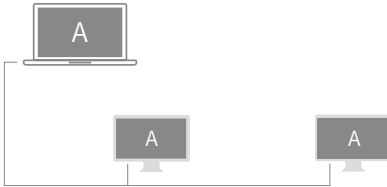

##### Extend Mode

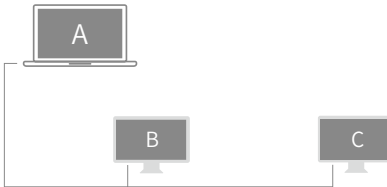

#### 3. Via USB-C DP Alt Mode laptops

##### Duplicate Mode

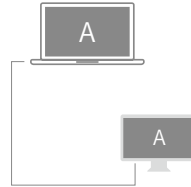

##### Extend Mode

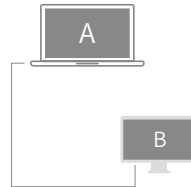

## 2.2 For macOS

1. For M4 Standard/Pro/Max, M3 Pro/Max, M2 Pro/Max, M1 Pro/Max, Intel chip with Thunderbolt 3 with macOS 15 or later

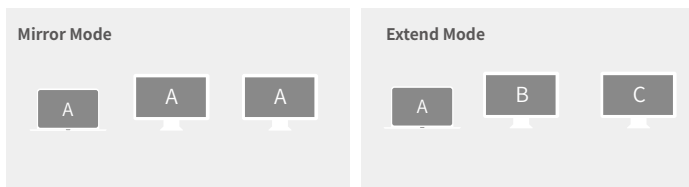

2. For M1 / M2 / M3 Standard with macOS 15 or later

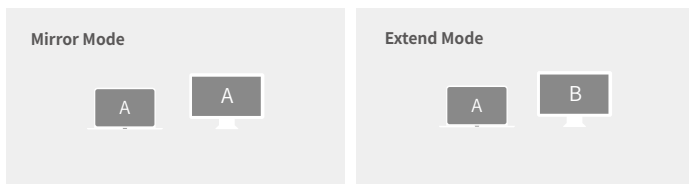

## 3 Video Resolution and Refresh Rates

1. The table below shows the maximum supported specifications for this docking station. Actual display output may vary depending on the host devices and connected cables.
2. MacBooks connected to this docking station need to be running macOS 15 or above.
3. Some specific USB 4 laptops do not support connecting dual monitors via the docking station.
4. "/" means the devices are not supported.
5. When using USB-C to DP or USB-C to HDMI cables, ensure the cables' maximum supported resolution and refresh rates are  $\geq$  the target output resolution and refresh rate.
6. Outputting dual 8K@60Hz displays or triple 4K@120Hz displays may impose significant load on the host computer's resources. This could potentially result in slow performance or unexpected system restarts.

### 3.1 High-Resolution Settings

Host Device	Host Port / Model	Single Display	Dual Display	Triple Display
Windows Laptop	Thunderbolt 5	8K@60Hz	8K@60Hz	4K@144Hz
	Thunderbolt 4/USB4	8K@60Hz	6K@60Hz	/
	USB-C DP Alt Mode	4K@60Hz	/	/
MacBook	M5 Max	8K@60Hz	8K@60Hz	4K@144Hz
	M5 Pro	8K@60Hz	6K@60Hz	4K@144Hz
	M5	8K@60Hz	6K@60Hz	/
	M4 Max	8K@60Hz	8K@60Hz	/
	M4 Pro	8K@60Hz	6K@60Hz	/
	M4	8K@60Hz	6K@60Hz	/
	M3 Max	8K@60Hz	6K@60Hz	/
	M2/M3 Pro	8K@60Hz	6K@60Hz	/
	M2 Max	8K@60Hz	6K@60Hz	/
	M1 Pro/Max	6K@60Hz	6K@60Hz	/
	M1/M2/M3 Standard	6K@60Hz	/	/

### 3.2 High-Refresh Rate Settings

Host Device	Host Port / Model	Single Display	Dual Display	Triple Display
Windows Laptop	Thunderbolt 5	4K@240Hz	4K@240Hz	4K@144Hz
	Thunderbolt 4/USB4	4K@240Hz	2K@120Hz	/
	USB-C DP Alt Mode	2K@120Hz	/	/
MacBook	M5 Max	4K@240Hz	4K@240Hz	4K@144Hz
	M5 Pro	4K@240Hz	4K@240Hz+4K@165Hz	4K@144Hz
	M5	4K@240Hz	4K@144Hz	/
	M4 Max	4K@240Hz	4K@240Hz	/
	M4 Pro	4K@240Hz	4K@144Hz	/
	M4	4K@240Hz	4K@120Hz	/
	M3 Max	4K@240Hz	4K@165Hz	/
	M2/M3 Pro	4K@240Hz	4K@120Hz	/
	M2 Max	4K@240Hz	4K@144Hz	/
	M1 Pro/Max	4K@144Hz	4K@120Hz	/
	M1/M2/M3 Standard	4K@144Hz	/	/

## 4 Using the Product

1. Connect the DC plug of the power adapter to the docking station's DC port, and plug the AC plug of the power adapter into a power outlet. The indicator on the docking station will then turn green, confirming power supply is active.

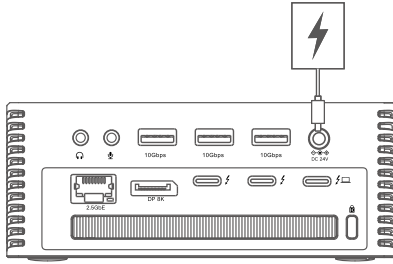

2. Connect your laptop to the Thunderbolt 5 upstream port on the docking station using the provided Thunderbolt 5 cable. The indicator will turn blue, confirming the docking station has connected to host devices.

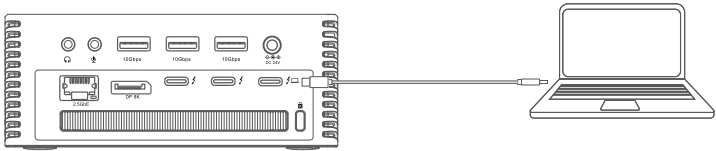

**Note:** To ensure all functions work properly, the Host port must remain connected to your laptop while using this product.

3. Connect other devices and enjoy.

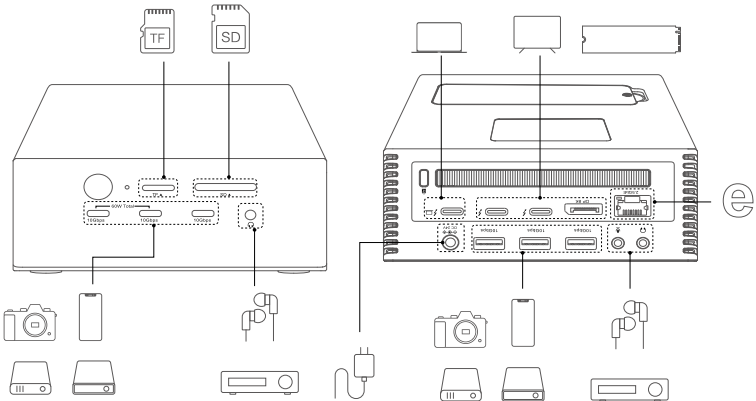

## 4.1 M.2 Installation

- Disconnect the docking station from all peripheral devices. Turn the docking station over, loosen the cover screws, and remove the bottom panel.
- Loosen the M.2 SSD fixing screw. (Only the top screw needs to be loosened; the bottom nut can be adjusted to accommodate different-sized drives.)
- Align the SSD connector with the slot and install it, then tighten the SSD screws.
- Take out the pad to peel off its protective film, and stick it along with the SSD, then peel off the protective film on the other side.
- Put back the panel and tighten the cover screws again.
- Connect the docking station to your laptop. A displayed drive letter on the computer indicates a successful installation.

**!** **Note:** The M.2 SSD mounting slot uses an adjustable split-screw design. During installation, loosen and remove the nut as needed according to the SSD length, reposition it to the appropriate standoff location, and then secure it again.

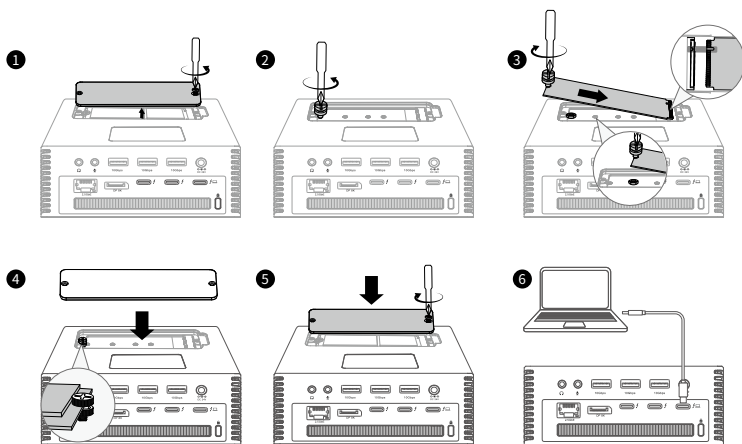

## 5 Specifications & Safety Warnings

### 5.1 Specifications

Working Temperature	32 °F ~ 104 °F (0°C ~ 40°C )
Storage Temperature	-4 °F ~ 158 °F (-20°C ~ 70°C )
Data Transfer Speed	120Gbps Max
Supported Systems	Windows 11, mac OS 15 and later

## 5.2 Safety Warnings

- Keep the Docking Station away from liquids and moisture. Exposure to liquids can result in damages, electric shock and fire hazard.
- Always unplug the device from the electrical outlet if there is a risk of lightning or if it will be unused for an extended period-of-time. Otherwise, there is an increased risk of electrical shock, short-circuiting, or fire.
- Protect your device from excessive exposure to dust during use or storage. Dust can build up inside the device, increasing the risk of electrical shock, short-circuiting, or fire.
- Please do not block or cover the heat sink on the device. It helps to keep the device cool during operation.
- Please do not attempt to repair or open the device yourself. Doing so can result in personal injury, damage the device, and will void the warranty. If you have any issues, please contact UGREEN Technical Support if necessary.
- For data safety, please do not directly disconnect the storage device from this product. Before disconnecting, please safely remove the external device from the computer.
- If not in use for prolonged periods, please carefully store the product to avoid dust and humidity.
- The drive cover features an insulating coating. Avoid scratching it with sharp objects to preserve its appearance.

## 6 Troubleshooting

### 6.1 Cannot Connect to the Laptop or Stops Working Intermittently

#### 1. Software Version Compatibility

a. Compatible with Windows 10 (23H2 or newer) and macOS 15.0 or later. Linux systems are not supported.  
b. Before use, it is recommended to update the following drivers for your laptop: system BIOS, graphics driver, Thunderbolt driver & firmware, and Ethernet driver.

**Note:** Outdated BIOS or drivers may cause the system to fail to recognize the docking station or affect its performance. Visit each hardware manufacturer's support page to obtain the latest drivers.

#### 2. Compatibility Issues

a. Ensure your laptop is compatible with Thunderbolt 5, 4, or USB4. Windows systems with Thunderbolt 3 are not supported.

b. The following tested incompatible products:

i. Lenovo Xiaoxin Pro16 IA7 2022

ii. Lenovo X1 (i7-1185G7)

iii. Xiaomi 15PRO Laptop

iv. Huawei MateBook 14 2023

v. DELL XPS 15 Book (i5-9300H)

vi. Dell Latitude 7740

vii. HP Elitebook 840 G6 (Intel i5-8365U)

viii. Huawei MateBook X Pro 2024

ix. ASUS ZenBook Flips (i7-1165G7)

#### 3. Cable Requirements

a. Use the included Thunderbolt 5 cable with the docking station. Using uncertified or incompatible cables may cause product malfunctions.

#### 4. Power Supply Issues

a. Use the provided power adapter with the docking station. Non-original adapters are not recommended.

b. Check that the power switch on the product is set to ON, and try pressing it multiple times.

#### 5. Interface Troubleshooting

a. Try connecting the docking station to another Thunderbolt/USB4 USB-C port (if available) on your Laptop. If the other port works, the original host port may have physical damage or internal failure.

If all steps above fail: Contact the docking station manufacturer's technical support and provide your computer model, OS version, and troubleshooting steps taken.

### 6.2 Cannot Connect to a Monitor or Dual/Triple Monitors

1. Please follow 6.1 What should I do if the dock cannot connect to my laptop or stops working intermittently? steps to make sure the dock is working.

2. Please refer to 2.3 summary in this manual to check the video output capability of the laptop and confirm that the device supports dual/triple-screen output.

3. Try a different display cable or monitor, ensuring the monitor's USB-C port supports video input if using a Thunderbolt port for screen mirroring, and verify the monitor is on the correct input.
4. Disconnect the dock from your computer and all connected devices for at least 5 minutes, then reconnect after rebooting your laptop to test if the issue is fixed.

### 6.3 Ethernet Port does not Support 2.5Gbps Internet Speed

**Note:** The Ethernet port of our docking station shares bandwidth with the USB interface(s) via the common USB bus. If the USB interface is engaged in high-speed data transfer, it may cause temporary network speed degradation due to bandwidth contention on the USB bus. This is a normal operational behavior in USB-based docking solutions when multiple high-bandwidth functions are used concurrently.

1. **Verify Ethernet Cable:** Ensure you're using a CAT6 or higher Ethernet cable (CAT5e may not support 2.5Gbps). Test with a known working 2.5Gbps-compatible cable.
2. **Router/Switch Support:** Confirm your router/switch port supports 2.5Gbps (check manufacturer specs). Plug the dock directly into the router's 2.5Gbps port (if available).
3. **Check Network Adapter Settings**

#### **a.Windows:**

- i. Press Win + X > Select Device Manager > Expand Network adapters.
- ii. Right-click the dock's Ethernet adapter (e.g., "USB3.1 Ethernet Adapter") > Select Properties.
- iii. Click the Advanced tab > In the "Property" list, select Speed & Duplex.
- iv. Ensure the value is set to Auto Negotiation or manually select 2.5 Gbps Full Duplex (if available).
- v. Restart your computer and test again.

#### **b.macOS:**

- i. Go to System Settings > Network > Select the dock's Ethernet connection (e.g., "USB10G Ethernet").
  - ii. Click Advanced > Go to the Hardware tab.
  - iii. Under "Configure", select Manually > Set "Speed" to 2.5 Gbps and "Duplex" to Full.
  - iv. If "2.5 Gbps" isn't an option, reset to Automatic and ensure the router supports auto-negotiation for 2.5Gbps.
  - v. Restart your Mac and test.
4. **Update Drivers/Firmware:** Please confirm drivers/firmware are up to date.

### 5. Test in Isolated Environment

- a. **Bypass the Dock:** Connect your computer directly to the router with the same Ethernet cable. Test speeds (use tools like Speedtest.net).
- b. **Disable Other Devices:** Temporarily disconnect all other devices from the router to eliminate bandwidth congestion.
- c. **Turn Off VPN/Proxy:** These can limit throughput; disable them temporarily for testing.

### 6.4 USB-A or USB-C port Stops Working or Functions Intermittently

1. Unplug the docking station from your laptop and all attached devices for a minimum of 5 minutes. After restarting your laptop, reconnect all components to determine if the issue has been resolved.
2. Verify whether peripheral devices operate correctly when directly connected to the laptop without the docking station.
3. Attempt using a different functional USB A or USB-C device to assess whether the port itself is defective.
4. If possible, test the dock with an alternative laptop to ascertain whether the problem persists.

### 6.5 SD Port or Micro SD Port is not Working

1. Unplug the docking station from your laptop and all attached devices for a minimum of 5 minutes. After restarting your laptop, reconnect all components to determine if the issue has been resolved.
2. Make sure the card is fully inserted into the port.
3. Try using a different SD card.
4. If possible, test the dock with an alternative laptop to ascertain whether the problem persists.

### 6.6 Audio Port is not Working

1. Unplug the docking station from your laptop and all attached devices for a minimum of 5 minutes. After restarting your laptop, reconnect all components to determine if the issue has been resolved.
2. Go to system settings to select the right audio output.
3. If possible, test the dock with an alternative laptop to ascertain whether the problem persists.
4. Try using a different pair of headphones.

## 7 FAQ

### 7.1 Compatibility Related

**Q1: Does this dock work with Thunderbolt 4 or 3 laptops? How do I check compatibility?**

A: This product is not compatible with Windows laptops equipped with Thunderbolt 3 ports but is compatible with Thunderbolt 5, 4, or USB4 laptops. Please note, some USB4 laptops may not support dual monitors with our docking station. For MacBooks, please make sure that the macOS is 15 or later.

**Q2: Can I use any USB-C to USB-C cable to replace the included Thunderbolt 5 cable?**

A: No, please use the included Thunderbolt 5 cable or certified Thunderbolt 5 cables only. Using uncertified or incompatible cables may cause functionality issues.

**Q3: Is it normal for a pop up screen to appear on my MacBook asking to allow the docking station(accessory) to connect?**

A: This is a new security feature in MacBook laptops containing Apple silicon and macOS 13 or later. When using the Thunderbolt connection for the first time with your MacBook, please select "Allow" so that your MacBook can recognize the docking station and enable its charging, data transmission, and video streaming features.

**Q4: Can I connect an external GPU to this docking station on my Silicon chip MacBook?**

A: NO. Apple Silicon-based Macs (including M1, M2, M3, and M4 models) lack support for external graphics processing units (eGPUs). This limitation is enforced at the system level by Apple: macOS will neither recognize nor utilize an eGPU, even if connected via an external docking station.

### 7.2 Display Related

**Q5: Can I connect a monitor to the front USB-C ports?**

A: No, the front USB C ports are for charging and data transfer, such as for phones, hard drives, webcams, and printers, and do not support video output. Only the rear Thunderbolt downstream ports can connect to monitors.

**Q6: Can I use a USB-C to HDMI or DP adapter/cable on the Thunderbolt downstream ports to connect a second HDMI or DP monitor?**

A: Sure. When using USB-C to DP or USB-C to HDMI adapter/cable, ensure its maximum supported resolution and refresh rates are  $\geq$  the target output resolution and refresh rate. UGREEN adapter/cable is recommended. Please note that when connecting USB-C to DP, only active adapters with a built-in conversion chipset are supported. Passive (level-shifting) adapters are not supported.

**Q7: Why isn't the resolution of my monitor reaching the desired specifications after connecting to the dock?**

A: Key factors affecting performance include:

- Monitor DSC Enablement
  - Monitors must have Display Stream Compression (DSC) activated to support high resolutions (e.g., 8K).
  - In multi-display setups, disabled DSC on any monitor may overload bandwidth, preventing other displays from reaching target resolutions.
- Host System Requirements
  - Ensure compatibility with Thunderbolt 5/4 or USB4 for adequate bandwidth.
  - Enable DSC on both the monitor and host (consult manufacturer guides).
  - Verify Thunderbolt/USB4 support, especially for multi-display use, to avoid resolution issues.

**Q8: When activating HDR, why does my laptop screen shutter or refuse to turn on after connecting a Thunderbolt/DP cord and selecting 8K/30Hz or 4K/60Hz?**

A: Since memory on a laptop graphics card is limited, lag may exist in the event high graphic quality takes up too much memory. If you meet such an issue, we suggest you turn off the HDR to release occupied memory.

**Q9: The monitor displays correctly after a black screen when plugging and unplugging the dock, is it normal?**

A: Yes. The monitor will display images after the EDID reading. This usually takes about 10s.

#### **Q10: How to deal with a black screen and display flickering when connecting to an external monitor?**

A: Please follow the steps below:

1. Please unplug and plug the Thunderbolt ports, and ensure there is an interval of more than 3 seconds.
2. Please try to lower the resolution and refresh rate.
3. Try another Thunderbolt cable.
4. Restart the laptop.

### **7.3 Charging Related**

#### **Q11: Why does my laptop display a "Low Power Charging" notification even though it is advertised to support 140W charging?**

A: Here are some possible reasons.

1. Cable Compatibility: Use a USB-C E-Marker cable (rated for 5A current). Standard USB-C cables ( $\leq 3A$ ) cannot support 140W.
2. Check Laptop PD Version: Verify your laptop's USB-C port supports charging and that it is compatible with the Power Delivery 3.1 (PD 3.1) protocol. Some laptops use proprietary charging protocols, which are fully compatible only with their original adapters, and thus, may show a low-power notification when using third-party docks.
3. Thermal Throttling: Overheating in the dock or laptop can reduce charging power.
4. Firmware/Software Mismatches: Outdated firmware or power management settings disrupt PD negotiation:

##### **a.Windows:**

- i. Update Chipset Drivers: Install the latest Intel/AMD chipset drivers (via Manufacturer Support > Drivers & Software).
- ii. Power Plan Settings: Go to Control Panel > Power Options > Select "High Performance" (not "Power Saver").

##### **b.macOS:**

- i. SMC Reset: For Intel Macs, shut down > Press Shift+Control+Option+Power button > Wait 10 seconds.
- ii. System Firmware Update: Ensure macOS is updated to the latest version (System Settings > Software Update).

### **7.4 Safety Related**

#### **Q12: Is it normal for my docking station to get warm or hot?**

A: As is the case with most electronic devices, the increased warmth is expected and does not represent a safety issue under normal operation, particularly if in use for extended periods of time. To accommodate the increase in temperature, the docking station is equipped with a built-in silicone pad to keep the temperature range within 32 °F ~ 104 °F (0°C ~ 40°C ) while in an environment temperature of around 25°C /77 °F .25°C /77 °F .

## **8 Technical Support**

If you run into any issues while using the dock, please contact UGREEN Technical Support.

Please contact us at any time by following these steps:

- a) Go to "Your Orders".
- b) Next to the relevant order, click "Problem with order".
- c) Click "Contact Seller" and send your message to us.