

# Stage Strobe Light

## USER MANUAL

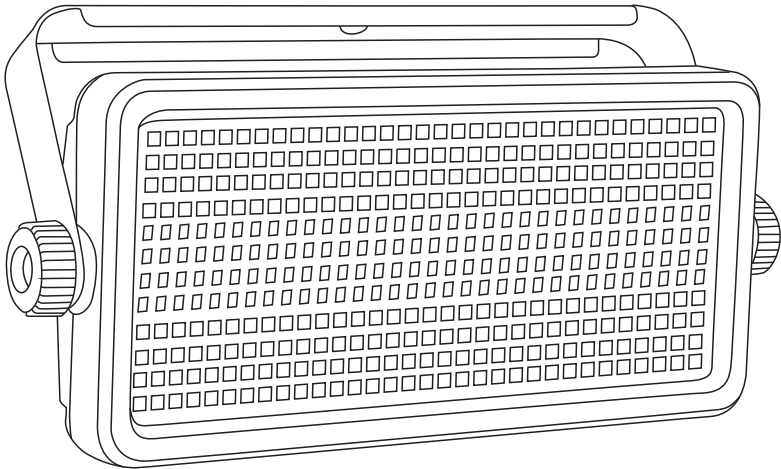

hyt-amz-sale@outlook.com

## WARNING

**FOR YOUR OWN SAFETY, PLEASE READ THIS USER MANUAL CAREFULLY BEFORE YOUR INITIAL START-UP!**



**CAUTION: Keep this equipment away from rain, moisture and liquids.**



### **SAFETY INSTRUCTIONS**

Every person involved with the installation, operation & maintenance of this equipment should:

- Be competent
- Follow the instructions of this manual



**CAUTION: Take care using this equipment! high voltage-risk of electric shock!!**



Before your initial start-up, please make sure that there is no damage caused during transportation. Should there be any, consult the seller and do not use the equipment.

To maintain the equipment in good working condition and to ensure safe operation, it is necessary for the user to follow the safety instructions and warning notes written in this manual.

Please note that damages caused by user modifications to this equipment are not subject to warranty.

### **Digital display operate:**

*a). Illustration part:*

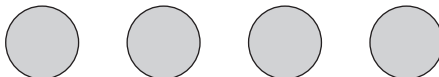

MENU      UP      DOWN      ENTER  
A          B          C          D

**A.MENU**  
**B.UP**  
**C.DOWN**  
**D.ENTER**

### **Operation Instructions:**

After startign press A(MENU) Enter into main-menu,  
Press B(UP) C(DOWN) to select the submenu,  
and then press D(ENTER) to ensure.



**ATTENTION:**  
**DANGER OF LIFE! RISK OF BURNS!**  
**RISK OF FIRE! RISK OF SHORT CIRCUIT!**

## DMX Signal Connection

3-Pin XLR to 5-Pin XLR Conversion		
Conductor	3-Pin XLR Female (OUT)	5-Pin XLR Male (IN)
Ground/Shield	Pin 1	Pin 1
Data Compliment (-signal)	Pin 2	Pin 2
Data True (+signal)	Pin 3	Pin 3
Not Used		Pin 4-Do Not Used
Not Used		Pin 5-Do Not Used

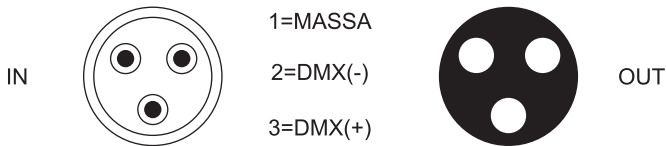
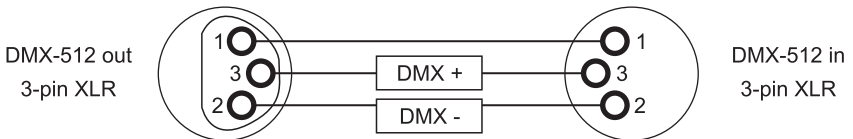
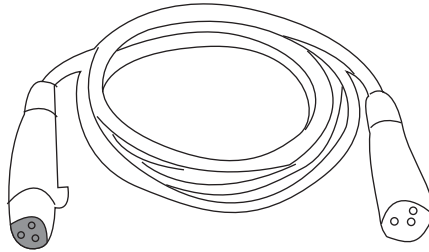

### Technical Specifications:

Voltage: AC110-240V, 50/60HZ

Power: 120W

LED: 256PCS 5050 RGB LED, 128PCS 5730 White LED

DMX Channel: 6/9/64/112CH

## SETTING MENU LED DISPLAY:

Mode	Programming		Description	
Auto mode	Auto	Sp1-10	Auto Speed 1-10(slow-fast)	
		St0-9	Strobe Speed 0-9(slow-fast)	
DMX mode	Addr	6CH	A001-A507	
		9CH	A001-A504	
		64CH	A001-A449	
		112CH	A001-A401	
Each channel mode is a separate address, plugged into the console, automatically enter DMX mode				
Show	Shou	Sh 1-12	Program Show 1-12	
		Sp 1-10	Program Speed 1-10(slow-fast)	
		St 0-9	Program Flash 0-9(slow-fast)	
Sound Mode	Soud	Sen 1-9	Sound Sensitivity 1-9	
Slave	SLAV	Slave	Slave (Slave, automatically identify the master)	
Edit color	Colo	r000-255	Red (0-100%) Red Dimming	
		g000-255	Green (0-100%) Green Dimming	
		b000-255	Blue (0-100%) Blue Dimming	
		U000-255	White (0-100%) White Dimming	
		St 0-9	LED Strobe(slow-fast)	
Static colors	StAt	CL01-CL37	Static Color	
		St 0-9	LED Strobe(slow-fast)	
Product Set	Set	dis	10s	Blacklight shutoff time ,from 10s to always on
			20s	
			30s	
60s				
on				
Send	temp	50~6 5°C	Protecting temperature settings,protection within the range of 50~65°C,exceeding this range began to reduce output power	
			yes	Send one-click settings, and the channel mode of all lamps is the channel mode of the current master
Information	Info	ver	Vxxx	Current software version
		temp	XX C	The current light plate temperature (degrees Celsius), if the temperature detection line fails, the boot prompt-RT-, the menu display EROR

## DMX MODE 1:6 CH

CH1	0-255	Master Dimmer	
CH2	0-9	No Function	Strobe
	10-255	Slow-Fast	
CH3	0-255	ALL RED (0-100%)	
CH4	0-255	ALL GREEN (0-100%)	
CH5	0-255	ALL BLUE (0-100%)	
CH6	0-255	ALL WHITE (0-100%)	

## DMX MODE 2:9 CH

CH1	0-255	Master Dimmer	
CH2	0-255	ALL RED (0-100%)	
CH3	0-255	ALL GREEN (0-100%)	
CH4	0-255	ALL BLUE (0-100%)	
CH5	0-255	ALL WHITE (0-100%)	
CH6	0-9	No Function	Strobe
	10-255	Slow-Fast	
CH7	0-6	CH2-CH4 No Function	
	7-13	Pattern Effect 1 (CH2-CH4 control the pattern color)	
	14-20	Pattern Effect 2 (CH2-CH4 control the pattern color)	
	、 、 、	、 、 、	
	237-244	Pattern Effect 35 (CH2-CH4 control the pattern color)	
	245-251	Auto Effect (Circle running pattern effect 1~35, CH2-CH4 control the pattern color)	
	252-255	Sound Active Mode (CH8 is invalid)	
			5050RGB Effect Channel

CH8	0-6	CH5 No Function	5730-W Effect Channel
	7-13	Effect 1	
	14-20	Effect 2	
	、 、 、	、 、 、	
	224-230	Effect 32	
	231-255	Auto Effect (Circle running pattern effect 1~32)	
CH9	0-255	DMX Program Speed(Slow-fast)	

### DMX MODE 3:64CH

Control zones for DMX control (64CH)

RGB 1	RGB 2	RGB 3	RGB 4	RGB 5	RGB 6	RGB 7	RGB 8	RGB 9	RGB 10	RGB 11	RGB 12	RGB 13	RGB 14	RGB 15	RGB 16
W1	W2	W3	W4	W5	W6	W7	W8	W9	W10	W11	W12	W13	W14	W15	W16
RGB 1	RGB 2	RGB 3	RGB 4	RGB 5	RGB 6	RGB 7	RGB 8	RGB 9	RGB 10	RGB 11	RGB 12	RGB 13	RGB 14	RGB 15	RGB 16

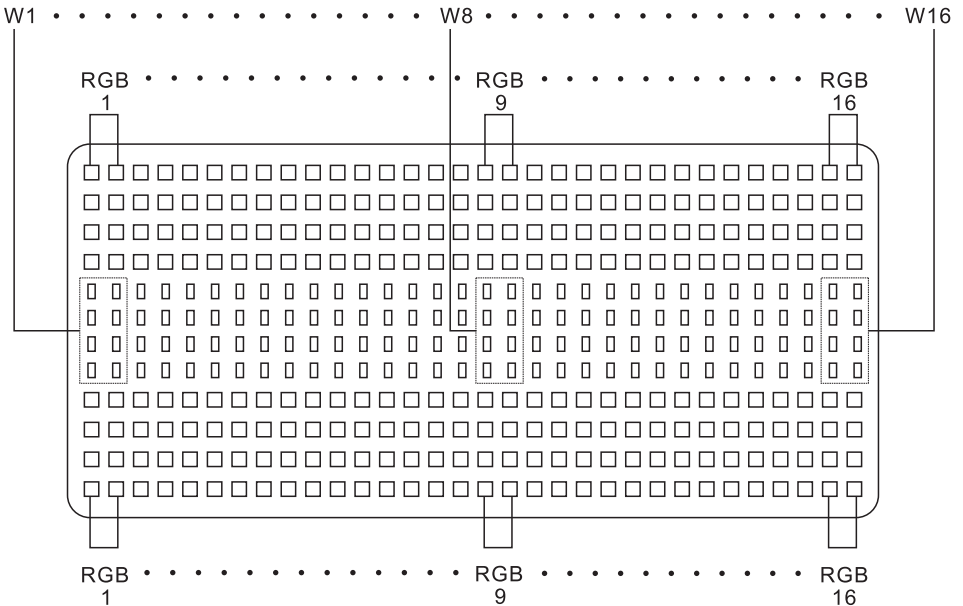

CH1	0-255	RGB1 RED (0-100%)
CH2	0-255	RGB1 GREEN (0-100%)
CH3	0-255	RGB1 BLUE (0-100%)
、 、 、	、 、 、	、 、
CH46	0-255	RGB16 RED (0-100%)
CH47	0-255	RGB16 GREEN (0-100%)
CH48	0-255	RGB16 BLUE (0-100%)
CH49	0-255	W1 (0-100%)
、 、 、	、 、 、	、 、 、
CH63	0-255	W15 (0-100%)
CH64	0-255	W16 (0-100%)

### DMX MODE 4:112CH

Control zones for DMX control (112CH)

RGB 1	RGB 2	RGB 3	RGB 4	RGB 5	RGB 6	RGB 7	RGB 8	RGB 9	RGB 10	RGB 11	RGB 12	RGB 13	RGB 14	RGB 15	RGB 16
W1	W2	W3	W4	W5	W6	W7	W8	W9	W10	W11	W12	W13	W14	W15	W16
RGB 17	RGB 18	RGB 19	RGB 20	RGB 21	RGB 22	RGB 23	RGB 24	RGB 25	RGB 26	RGB 27	RGB 28	RGB 29	RGB 30	RGB 31	RGB 32

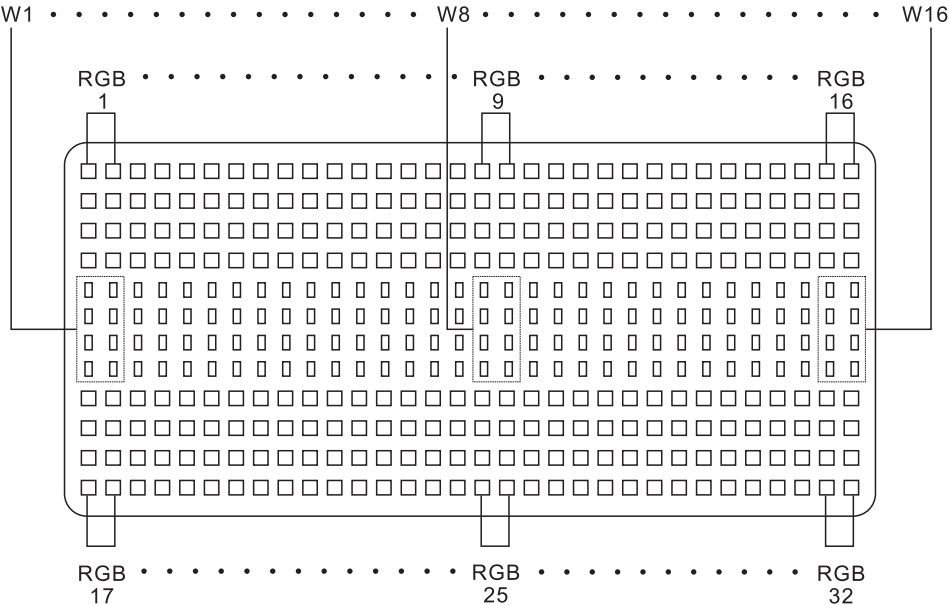

CH1	0-255	RGB1 RED (0-100%)
CH2	0-255	RGB1 GREEN (0-100%)
CH3	0-255	RGB1 BLUE (0-100%)
CH4	0-255	RGB2 RED (0-100%)
CH5	0-255	RGB2 GREEN (0-100%)
CH6	0-255	RGB2 BLUE (0-100%)
、 、 、	、 、 、	、 、 、
CH94	0-255	RGB32 RED (0-100%)
CH95	0-255	RGB32 GREEN (0-100%)
CH96	0-255	RGB32 BLUE (0-100%)
CH97	0-255	W1 (0-100%)
、 、 、	、 、 、	、 、 、
CH112	0-255	W16 (0-100%)

## Orientation :

The Strobe Light may be mounted in any position; however, make sure adequate ventilation is provided around the product.

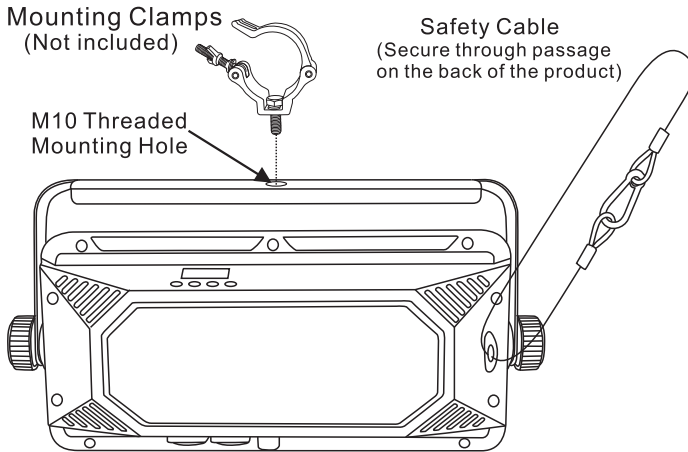

## MAINTENANCE

Dust build-up reduces light output performance and can cause overheating. This can lead to reduction of the light source's life and/or mechanical wear. To maintain optimum performance and minimize wear, clean your lighting products at least twice a month. However, be aware that usage and environmental conditions could be contributing factors to increase the cleaning frequency.

To clean the product, follow the instructions below:

1. Unplug the product from power.
2. Wait until the product is at room temperature.
3. Use a vacuum (or dry compressed air) and a soft brush to remove dust collected on the external surface/vents.
4. Clean all transparent surfaces with a mild soap solution, ammonia-free glass cleaner, or isopropyl alcohol.
5. Apply the solution directly to a soft, lint free cotton cloth or a lens cleaning tissue.
6. Softly drag any dirt or grime to the outside of the transparent surface.
7. Gently polish the transparent surfaces until they are free of haze and lint.

 Always dry the transparent surfaces carefully after cleaning them.



**CAUTION: Take care using this equipment!  
high voltage-risk of electric shock!!**

