

MUNBYN

Munbyn,
More choice for your growing business

Version 2.00

MUNBYN

ITPP047
Easy Setup Guide



1.0 Introduction	1
2.0 Check the Packing List	1
3.0 Paper Loading	2
4.0 Initial Setup	
4.1 Set Up The ITPP047 for First Use on Windows	3
4.1.1 Download Windows Driver	3
4.1.2 USB Interface	3
4.1.3 LAN Interface	4
4.1.4 Bluetooth Printer Installation	5
4.1.5 Wi-Fi Printer Installation	6
4.2 Set Up The ITPP047 for First Use on MacBook	7
4.2.1 Download MacBook Driver	7
4.2.2 USB Interface	8
4.2.3 LAN Interface	9
4.2.4 Wi-Fi Printre Installation	10
4.3 Set Up The ITPP047 for First Use on Linux	11
4.4 Set Up The ITPP047 for First Use on Chromebook	12
4.5 Set Up The ITPP047 for First Use on Android	14
4.5.1 Wi-Fi Printer Installation	14
4.5.2 Bluetooth Printer Installation	15

1.0 Introduction

This document explains the setup procedure for the ITPP047. Please read the instructions before using the printer. For further instructions, please refer to the ITPP047 software manual.

<http://u.pc.cd/XoActaK>



2.0 Check the Packing List



1. Printer
2. Power Cord
3. Roller
4. USB Cable
5. Roller Paper
6. USB Flash Drive
7. Power Adaptor
8. USB Cable

In case of omission or damage, please contact us via the contact details below.



support@munbyn.com



+8617817881067



munbyn



Monday to Friday 24 hours

3.0 Paper Loading

1. Press the cover opening button and then open the cover.
2. Insert a roll of paper in the direction shown in the illustration.

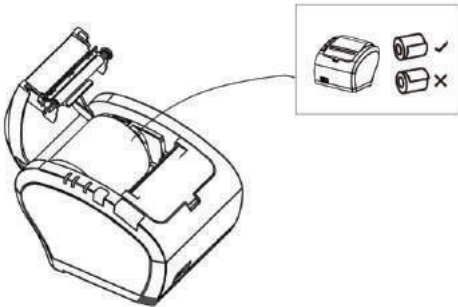

3. Pull the end of the paper out straight, and push down the printer cover to close.

4.0 Initial Setup

4.1 Set Up The ITPP047 for First Use on Windows

4.1.1 Download Windows Driver

You can get the driver from the included USB flash drive at this path: Driver CD → Driver → Windows Driver or click the link below to download the driver.

Driver download: <https://munbyn.biz/047Wind>

Setting tool download: <https://munbyn.biz/tool51>

4.1.2 USB Interface

- 1) Connect the printer to the power outlet via the power cord.
- 2) Connect the printer to your Windows computer via USB.
- 3) Place the thermal paper into the printer and power it on.

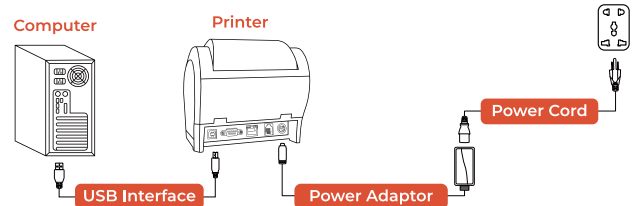

Open the downloaded driver and install it.

Demo video: <http://u.pc.cd/enX>

4.1.3 LAN Interface

- 1) Connect the printer to the router with a network cable.
Please see the picture below.

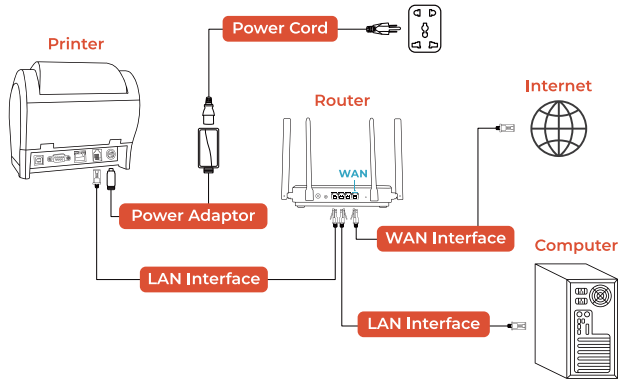

Open the downloaded driver and install it, then follow the demo video to configure the LAN.

- 2) Connect the printer to the router with a network cable.
Please see the below picture.

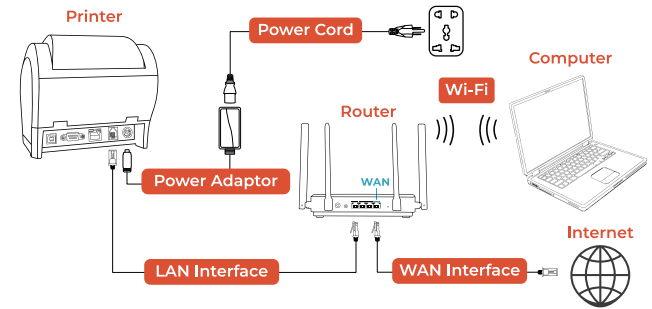

Open the downloaded driver and install it, then follow the demo video to configure the LAN.

Demo video: <http://u.pc.cd/rmD>



4.1.4 Bluetooth Printer Installation

Open the downloaded driver and install it, then follow the demo video to configure Bluetooth.

Demo video: <http://u.pc.cd/SKUrtalk>



4.1.5 Wi-Fi Printer Installation

- 1) Connect your computer to the wireless router.
Please see the picture below.

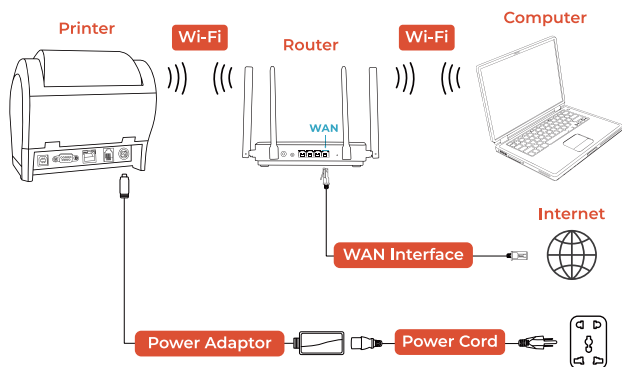

- 2) Connect the computer to the router with a network cable.
Please see the picture below.

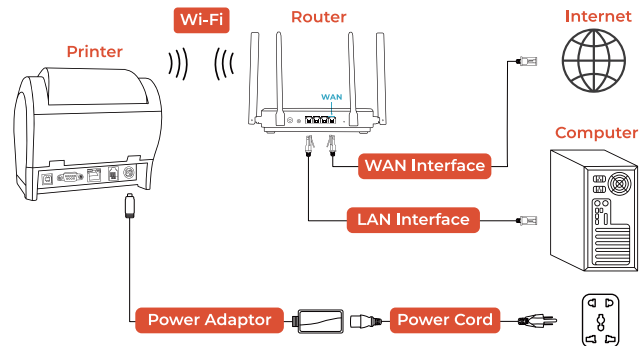

Open the downloaded driver and install it, then follow the demo video to configure Wi-Fi.

Demo video: <http://u.pc.cd/L9lctaIK>



4.2 Set Up The ITPP047 for First Use on MacBook

4.2.1 Download MacBook Driver

You can get the driver from the included USB flash drive at this path: Driver CD → Driver → Mac Driver.

You can also click the link below to download the driver.

Driver download: <http://u.pc.cd/jxP7>

4.2.2 USB Interface

- 1) Connect the printer to the power outlet via the power cord.
- 2) Connect the printer to your Windows computer via USB.
- 3) Place the thermal paper into the printer and power it on.

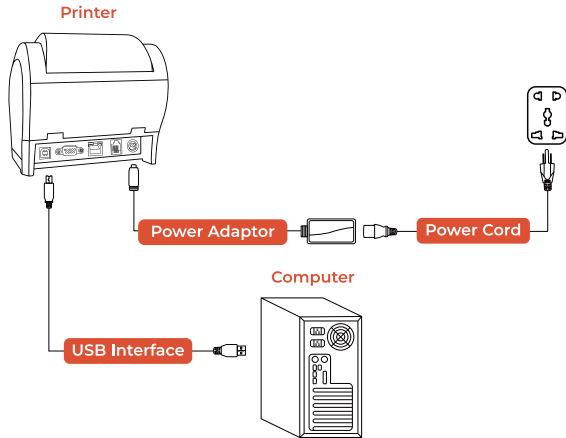

Open the downloaded driver and install it.

Demo video: <https://munbyn.biz/Mac-Install>



4.2.3 LAN Interface

Connect your computer to the wireless router. Please see the below picture.

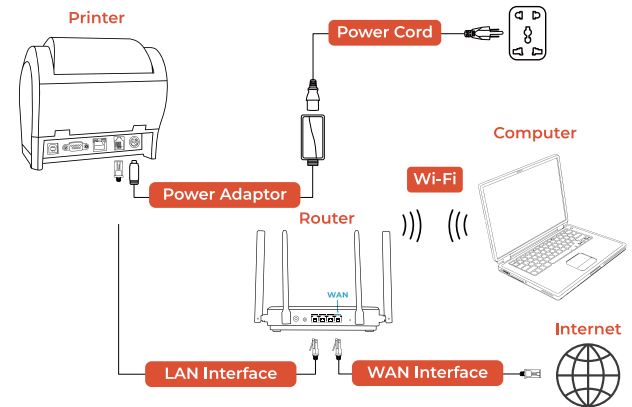

Open the downloaded driver and install it, then follow the demo video to configure the LAN.

Demo video: <https://munbyn.biz/Mac-LAN>



4.2.4 Wi-Fi Printer Installation

Connect your computer to the wireless router.
Please see the picture below.

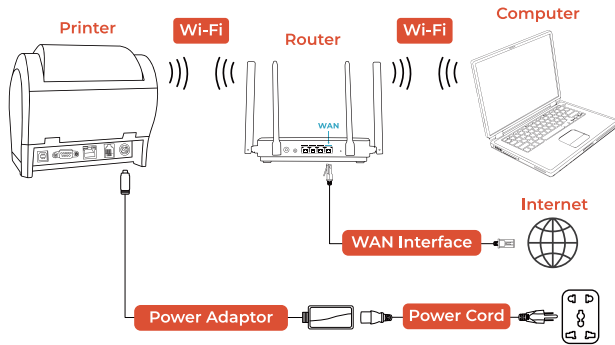

Open the downloaded driver and install it, then follow the demo video to configure Wi-Fi.

Demo video: <https://munbyn.biz/Mac-WIFI>

4.3 Set Up the ITPP047 for First Use on Linux

You can get the driver from the included USB flash drive at this path: Driver CD → Driver → Linux Driver. You can also click the link below to download the driver.

Driver download link: <http://u.pc.cd/jxP7>

- 1) Connect the printer to the power outlet via the power cord.
- 2) Connect the printer to your Windows computer via USB.
- 3) Place the thermal paper into the printer and power it on.

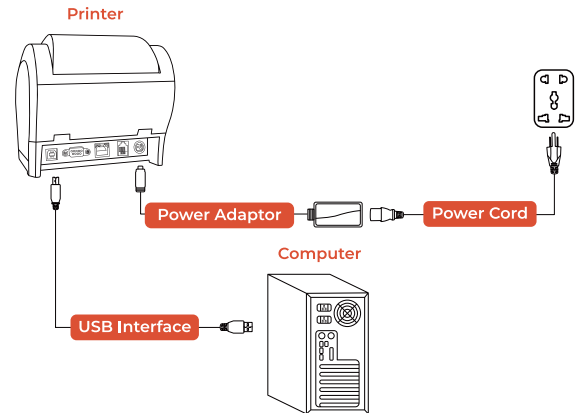

Demo video: <http://u.pc.cd/Rzjctalk>



4.4 Set Up The ITPP047 for First Use on Chromebook

- 1) Connect the printer to the power outlet via the power cord.
- 2) Connect the printer to your Windows computer via USB.
- 3) Place the thermal paper into the printer and power it on.

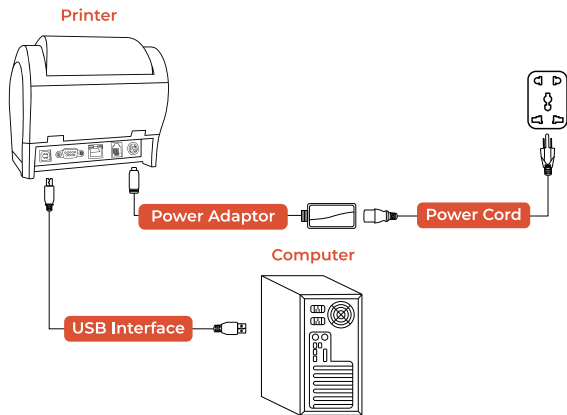

4) Enter in Google Chrome: <https://munbyn.biz/chromebookprint>

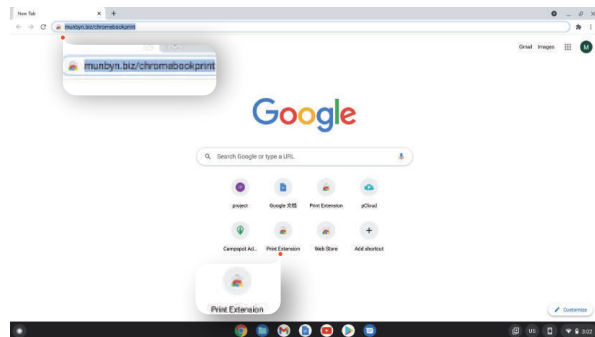

5) Click "Add to Chrome" first, and then click "Add extension" to download and add the extension.

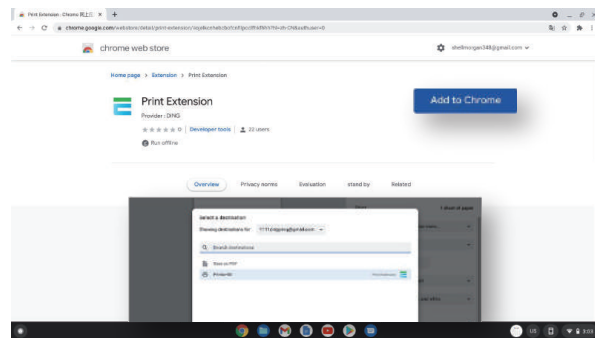

6) Follow the demo video to add the printer.

Demo video: <http://u.pc.cd/Bh3italK>



4.5 Set Up The ITPP047 for First Use on Android

4.5.1 Wi-Fi Printer Installation

Prepare a router and a network cable, and connect the network cable to the router.

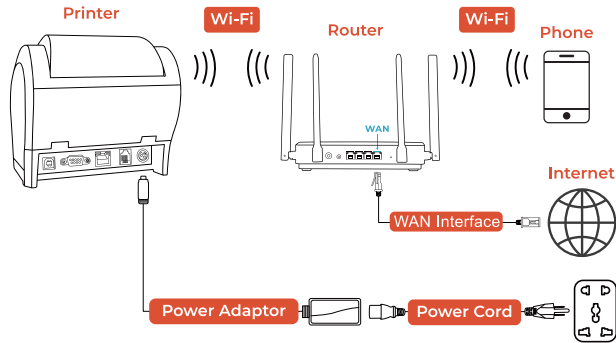

Wi-Fi Connection

Follow the Wi-Fi setup demo video to set up the printer to connect to your router, and finally connect the printer by using the IP address on your Android device.

Wi-Fi setup demo video: <https://munbyn.biz/047AndroidW>



Use the IP address to connect the printer in the Android POS App. Take Loyverse App as an example.

Android App Wi-Fi Connection demo video :

<https://munbyn.biz/ITPP047-W-L>



4.5.2 Bluetooth Printer Installation

Connect the printer with the ELabel App on an Android device: <https://munbyn.biz/047Android>

Connect the printer with your POS App to your Android device: <http://u.pc.cd/87ortalK>

<http://u.pc.cd/F5ectalk>



Bluetooth Setup Tool (Android)

Contact us

MUNBYN provides 18 months warranty and lifetime free service. If you encounter any issues with the product, please contact the MUNBYN team to promptly receive troubleshooting tips or a replacement.

Email: support@munbyn.com (24-7 online support)

Website: www.munbyn.com (how-to videos)

WhatsApp: +8617817881067