

KING || FALCON™

Automatic Directional Wi-Fi Antenna

Installation and Operating Instructions



KF1000 • White
KF1001 • Black

KING || WiFiMax™

includes the KING
WiFiMax Router
KWM1000



CONTENTS

OPERATION	1-20
INSTALLATION	22-29
TROUBLESHOOTING	30
SPECIFICATIONS	31
LIMITED WARRANTY	32
WIRELESS REGULATORY INFORMATION	33

NOTE: Please read thru this manual before using or installing.
You will need to download the free KING Wi-Fi app to
use this product (see page 1).

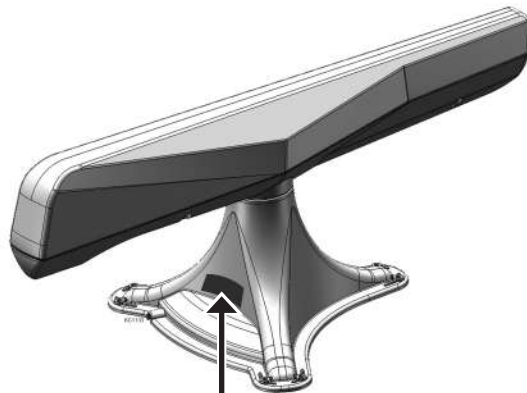

Record your serial number.

Thank you for choosing a KING Falcon antenna!

The KING Falcon is an outdoor, automatic directional 2.4GHz Wi-Fi antenna. Using the KING Wi-Fi app, the KING Falcon automatically rotates and scans 360 degrees and shows you all of the available networks. Simply tap the network you want and the KING Falcon automatically aims itself to get the best performance from that network.

The KING WiFiMax Wi-Fi Router/Range Extender creates your own private and secure Wi-Fi network, just like you have in your home. When you are in range of an available network, simply configure your KING WiFiMax to connect to that network, and it then extends the internet access from that network to your own private Wi-Fi network.

BEFORE USING YOUR KING FALCON ANTENNA



Before using the KING Falcon, you must download the free KING Wi-Fi app from the Apple® App Store® or Google Play™ Store. When in the store, search for “KING Wi-Fi.”



Make sure the power inserter and the KING WiFiMax router are connected and plugged in as shown.

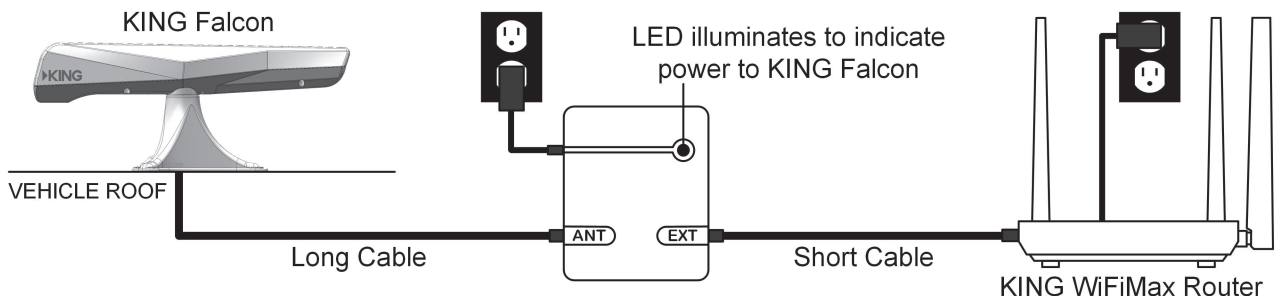

Do not power wash any part of the KING Falcon antenna head or base mount.

Power Inserter
Unplug power supply while vehicle is in motion.

FIRST-TIME USE: Go to the next page and follow the first-time use instructions.

IF YOU HAVE COMPLETED FIRST-TIME USE: Go to STANDARD OPERATION on page 16.

OPERATING NOTES

Do not operate the KING Falcon while the vehicle is in motion.

The KING Falcon will not locate Wi-Fi signals while the vehicle is in motion.

You must leave the power inserter and KING WiFiMax connected and plugged in while using your Wi-Fi.

Any time you move your vehicle, you will have to scan for a network again.

FIRST-TIME USE

1. SET UP KING WIFIMAX

NOTE: Make sure your KING WiFiMax and power injector are connected and powered on as shown on page one (blue lights on both devices will turn on when power is connected).

TIP

To maintain the best connection to your KING WiFiMax, it is suggested that the cellular network on your smart phone or tablet be turned off while completing the first-time setup.

1. Go to your smart phone or tablet's Wi-Fi settings page and connect to the KING 5G network:

KING_XXXXXX_5G

TIP

XXXXXX is a number/letter combination unique to your router and can be found on the bottom of your router in the SSID row.



Graphics will vary.

If you do not see **KING_XXXXXX_5G** (5GHz network), connect to **KING_XXXXXX** (2.4GHz network).

Always choose the 5G network if possible, as it is faster than the 2.4GHz network.

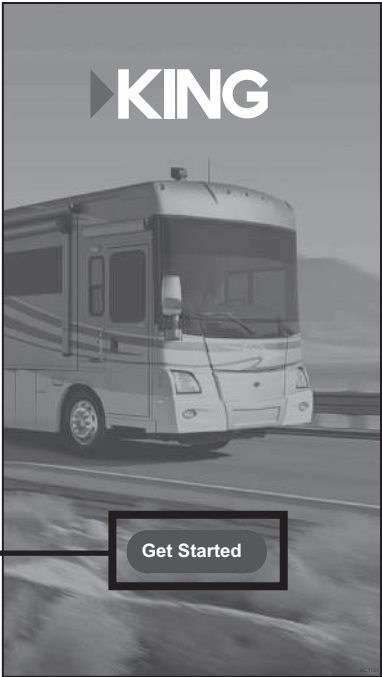

2. Open the KING Wi-Fi app and tap "Get Started."

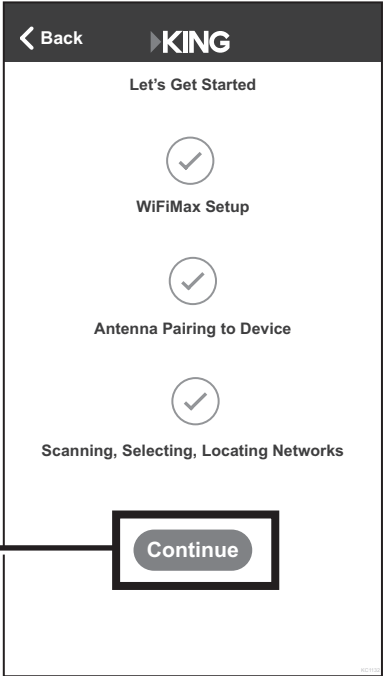

3. Tap "Continue" to begin your KING WiFiMax setup.

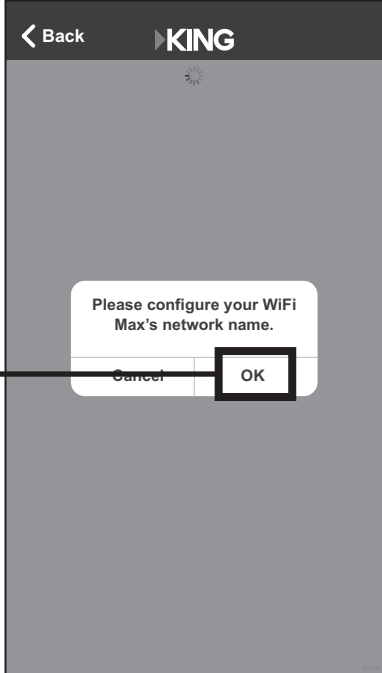

4. Tap "OK" on the pop up screen.

TIP Use your phone or tablet's zoom functionality to change the view of your screen.

5. Tap “WiFi Settings” in the left-hand column.

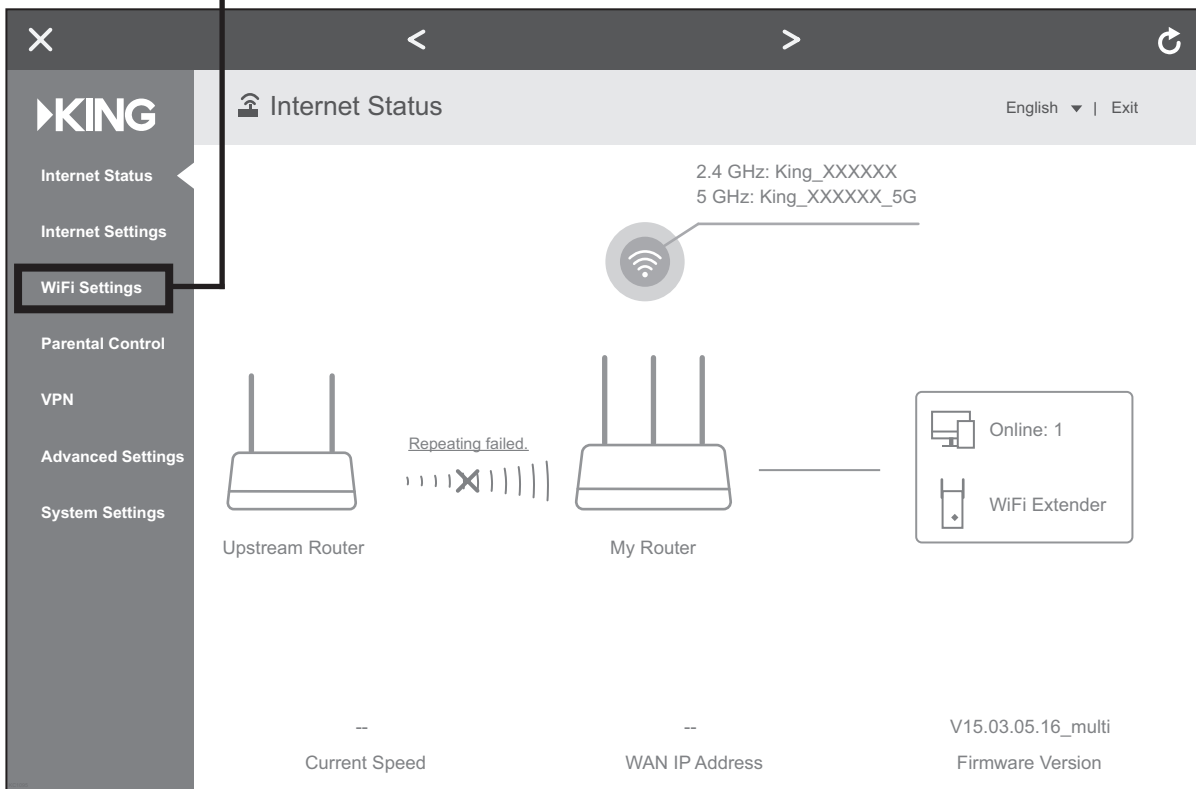

6. Tap “WiFi Name & Password.”

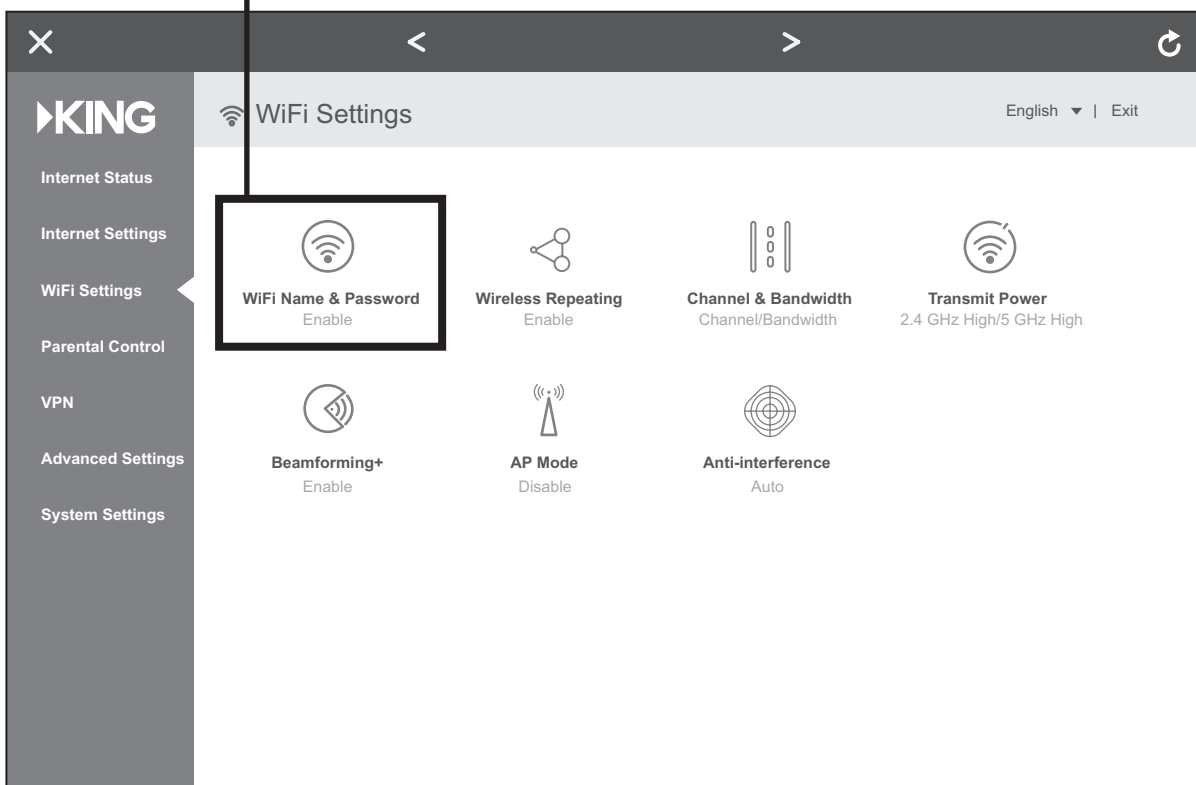

7. The screen below should appear. Here you **MUST** change your Wi-Fi name and password to personalize it and keep it secure. Do steps A and B for both the 2.4 GHz and 5GHZ networks (you will only have to do this once).

A Enter a new Wi-Fi name.



When entering your new names, make sure to **completely erase** the existing names in the boxes.



Add “_5G” after your 5GHz network name to differentiate it from your 2.4GHz network name.

B Enter a password.



KING highly recommends password protecting your name. Choose WPA/WPA2-PSK under “Encryption Mode” to enable password protection. Passwords can be the same for both networks if you wish, and must be at least 8 characters.

When you have entered names and passwords for **both** networks, tap “Save.”

Tap the “X” to exit the KING WiFiMax setup screen.

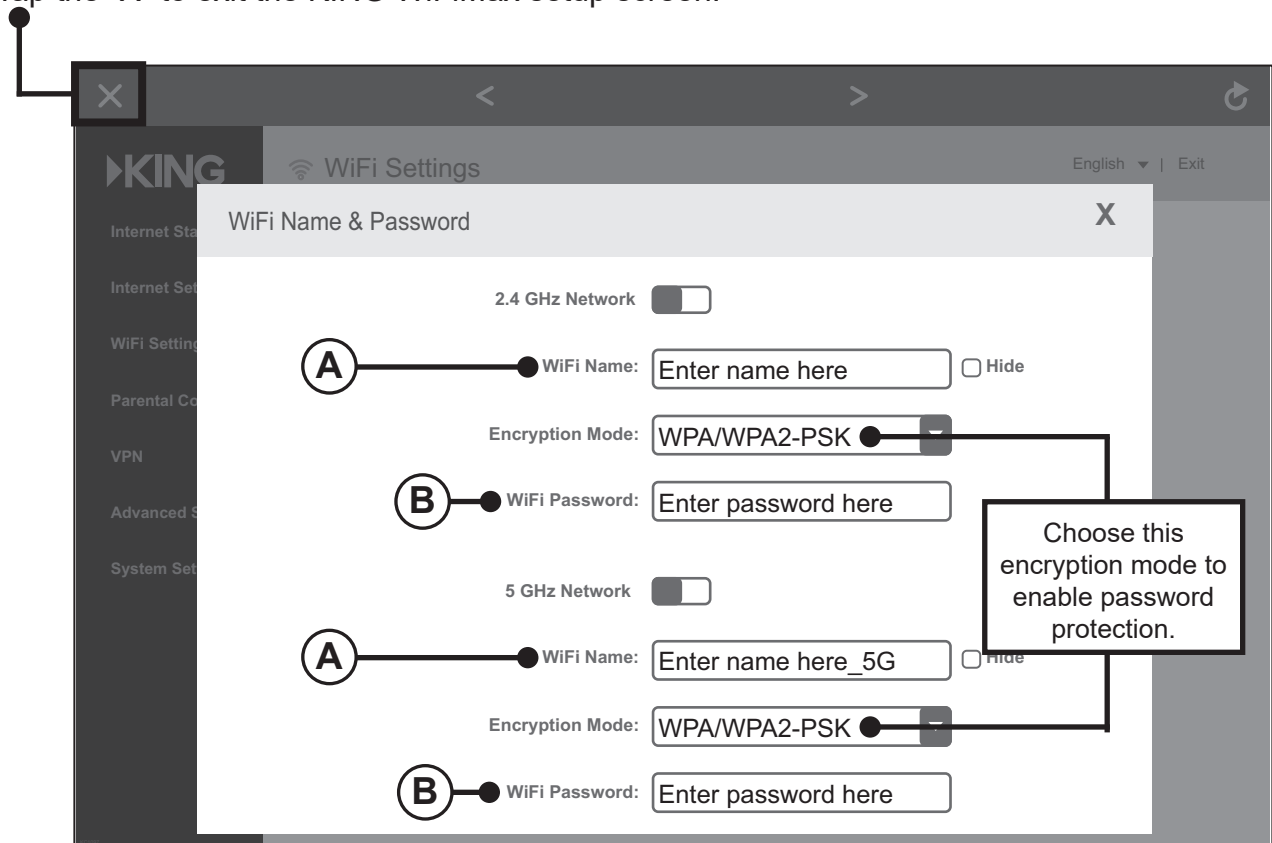

2.4G

Write your network name here:

Write your password here:

5G

Write your network name here:

Write your password here:

You have personalized your router setup.

Continue on next page. ➡

2. CONNECT TO THE KING WIFIMAX WITH YOUR PERSONALIZED NETWORK NAME

1. Once you have configured your KING WiFiMax network names in the previous step, this pop up will appear.



Do not click on “OK.” Instead, exit the app.



TIP For best performance, choose the 5GHz network whenever possible.

2. Go to your smart phone or tablet’s Wi-Fi settings page and connect to the Wi-Fi Network with your personalized network name.

If your device cannot connect to your 5GHz network, connect to your other network.

Example: ●

“MyWiFiName_5G”

This will be the name you created in step 7, page 5.



3. Once you have connected, return to the app and tap "OK" in the pop up window.

When the next screen appears, tap the "X" in the upper left hand corner.

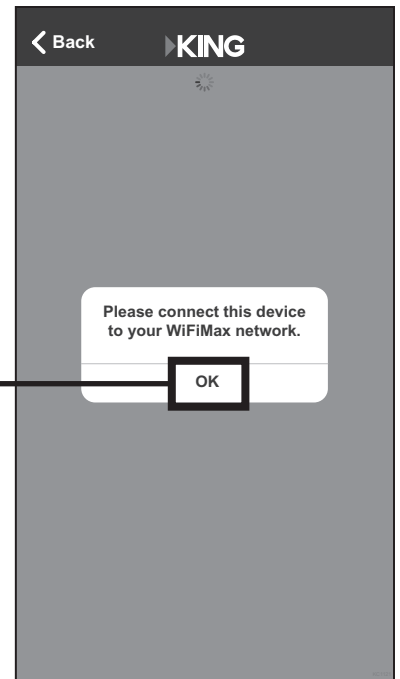

The KING WiFi app will confirm your KING WiFiMax setup and that the connection was successful. (Check mark turns green.)

4. To pair your antenna, tap "Continue" and go to the next page.

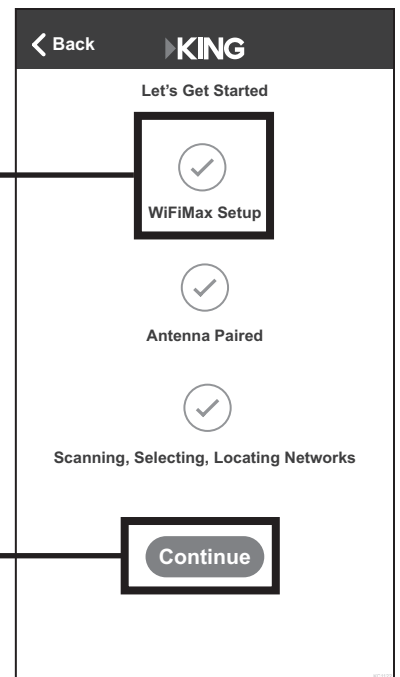

3. PAIR YOUR KING FALCON ANTENNA

1. A list of available KING Falcon antennas to connect to will appear. Identify your antenna and tap to select it.

TIP

If more than one antenna appears in the list: Match the last 5 digits of the antenna number to the serial number on the back of your KING Falcon to ensure you are selecting the correct antenna.

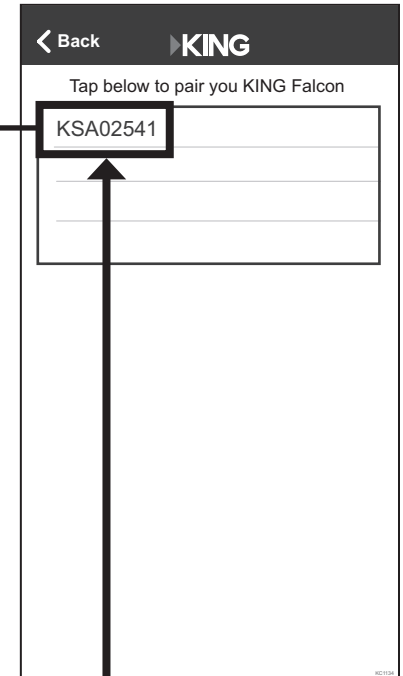
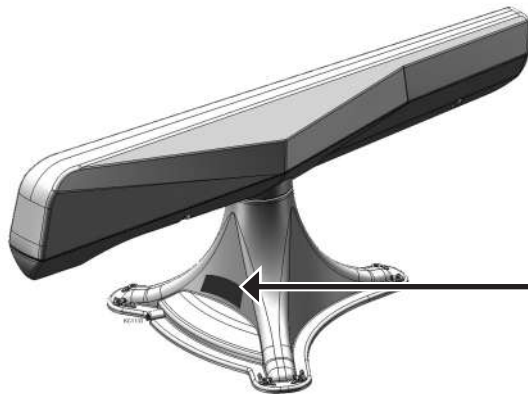

KSA02541

Example only:
your number will be different.

2. Enter the default PIN number, "0000" and tap "Continue" to pair your antenna.

You will be prompted to change your PIN - see next page.

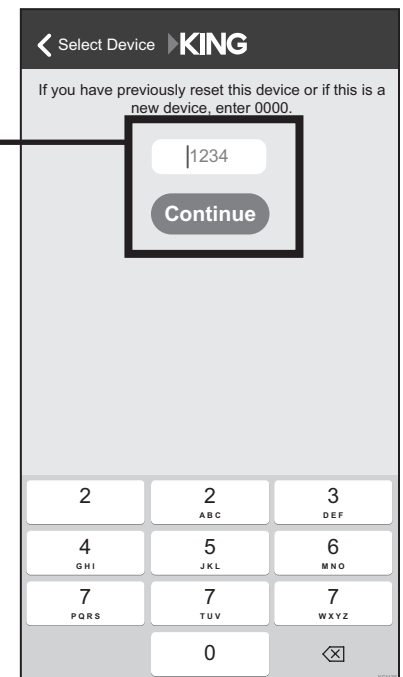

3. For increased security, you can change your PIN.

A second dialog box will allow you to do so. ●
If you do not wish to, tap “Cancel.”

Write your PIN here:

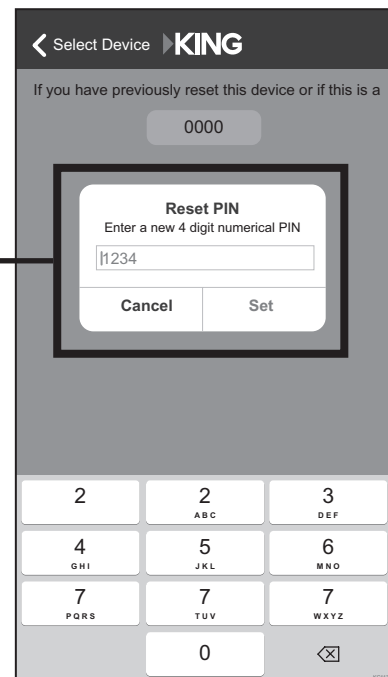

Only one smart phone or tablet can be paired with your KING Falcon antenna at a time. In the event you need to switch control of the KING Falcon antenna to a different device, and don't have the PIN, a PIN reset may be required.

TIP

Being paired with the antenna allows the user to aim and select upstream networks. You do NOT need to be paired to the KING Falcon to be connected to your personalized KING WiFiMAX network.

To un-pair from a KING Falcon antenna and allow another device to connect, disconnect Bluetooth to the KING Falcon.

The app will confirm your KING Falcon antenna is properly paired with your smart phone or tablet. (Check mark turns green.) ●

4. To scan for and select available Wi-Fi networks, tap "Continue" and go to the next page. ●

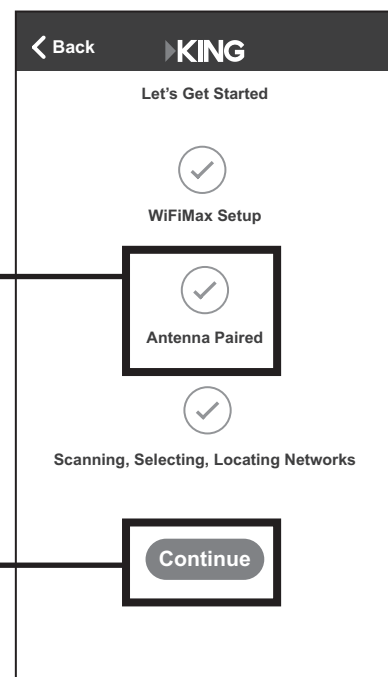

4. LOCATE & CONNECT TO AVAILABLE WI-FI NETWORKS

TIP

“Upstream” network refers to any network you would like to connect to. This could be a campground network, public Wi-Fi network, coffee shop, restaurant, hotel, etc.

Upstream networks may be password protected or accessible via captive portal. Contact the office, front desk, service counter, etc. to obtain the password or captive portal instructions at the location supplying the Wi-Fi.

1. The app will automatically begin to scan for available upstream networks. Once the scan is complete, select the upstream network that you would like to connect to.

Example: Fun Lake Campground



Do not select either of the 2.4GHz or 5GHz network names you created on page 5.

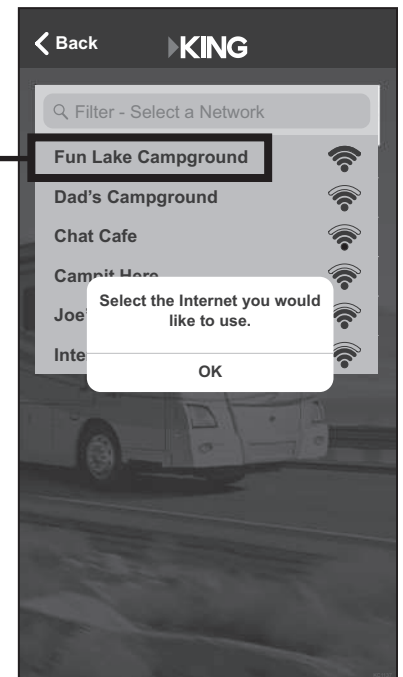
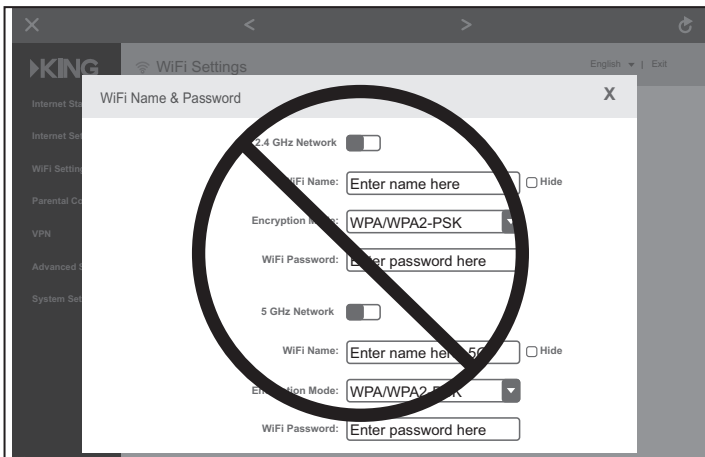

2. The KING Falcon will locate your selected network and confirm success.

3. Tap "Continue."

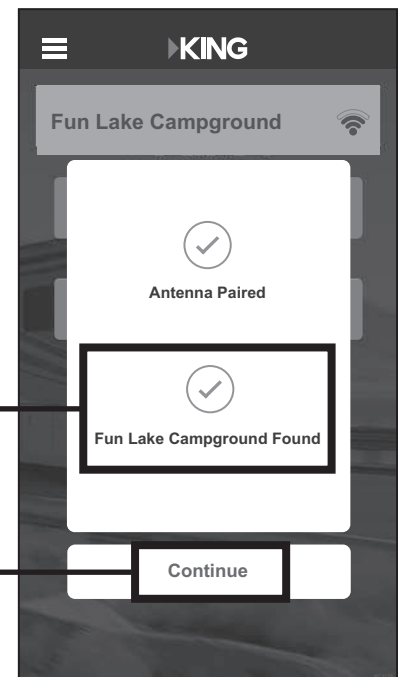

5. CONNECT TO YOUR KING WIFIMAX

1. Almost there! Tap "Continue."

2. Tap the menu icon to display menu options.

3. Tap on "KING WiFiMax Setup."

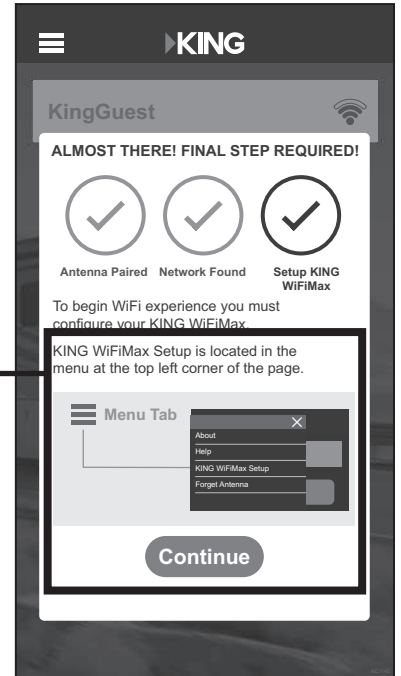
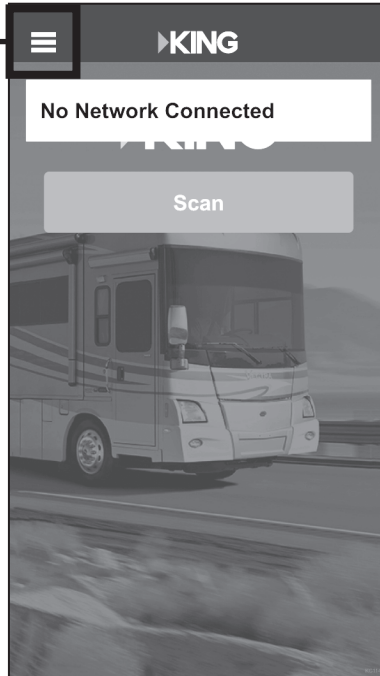

4. Tap “WiFi Settings” in the left-hand column.

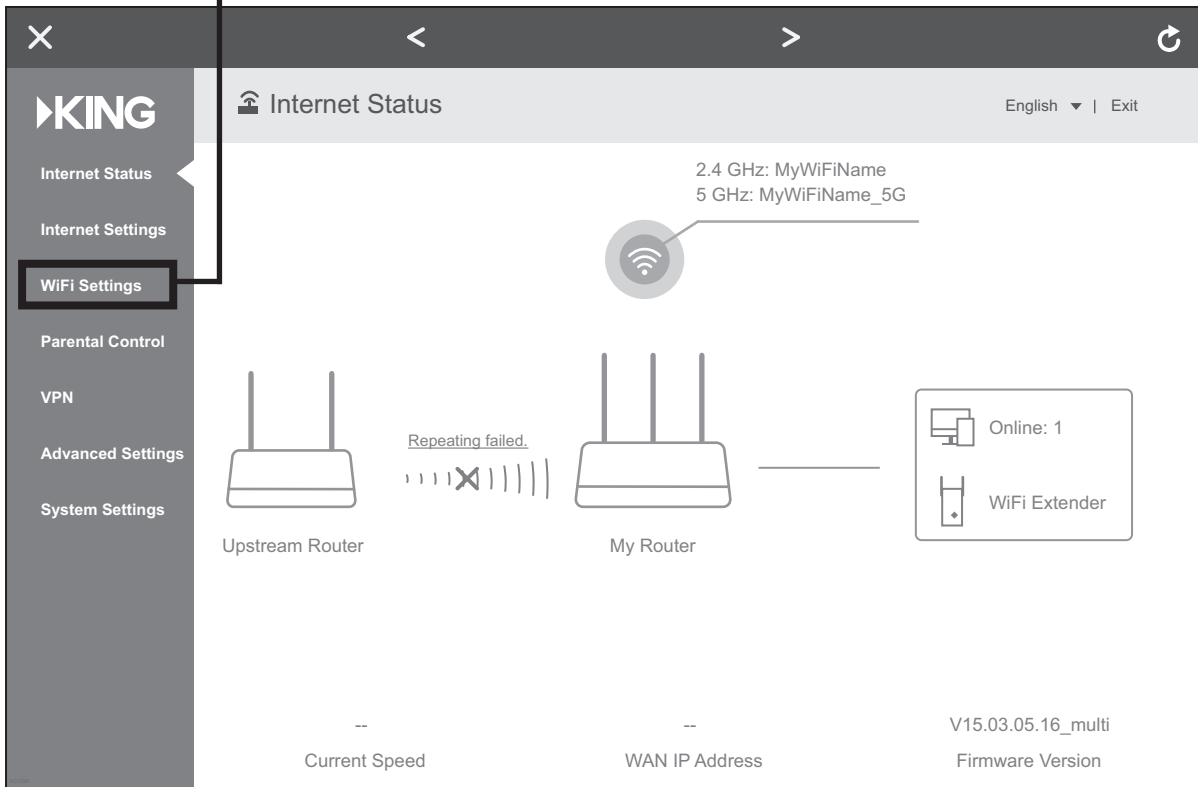

5. Tap “Wireless Repeating.”

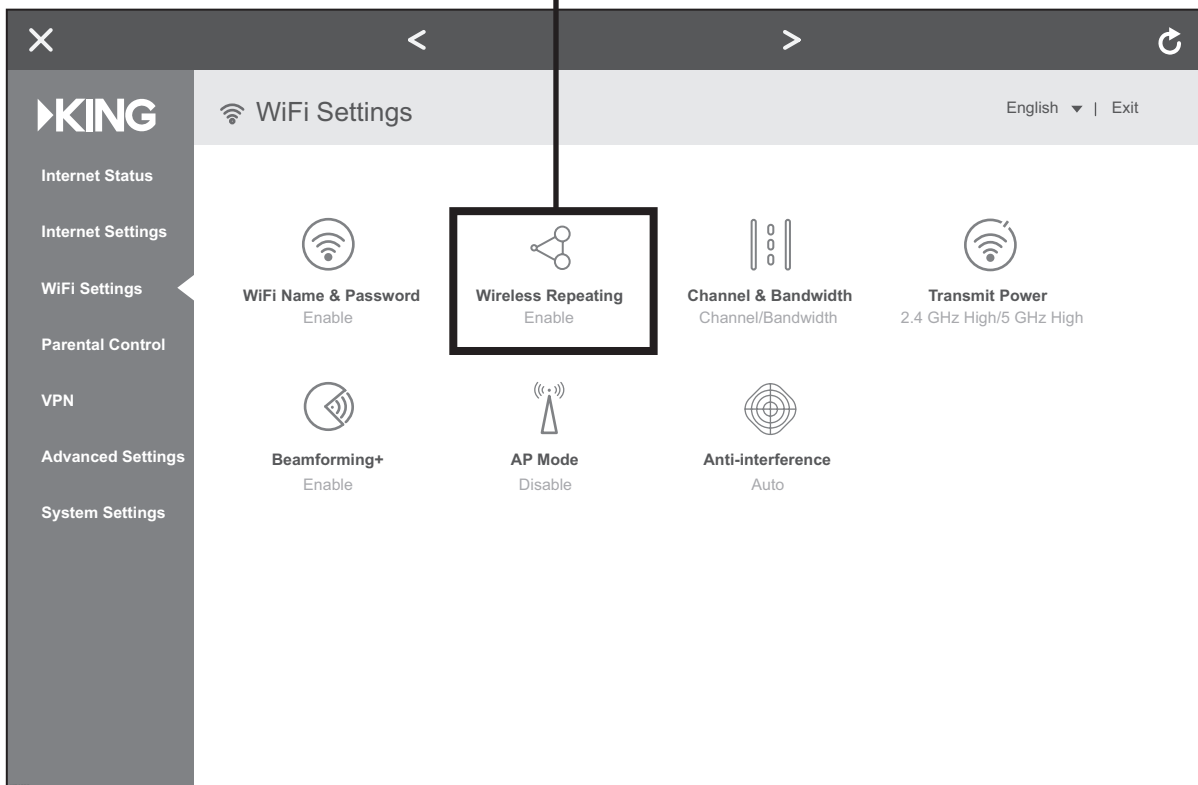

6. The router is scanning for networks.

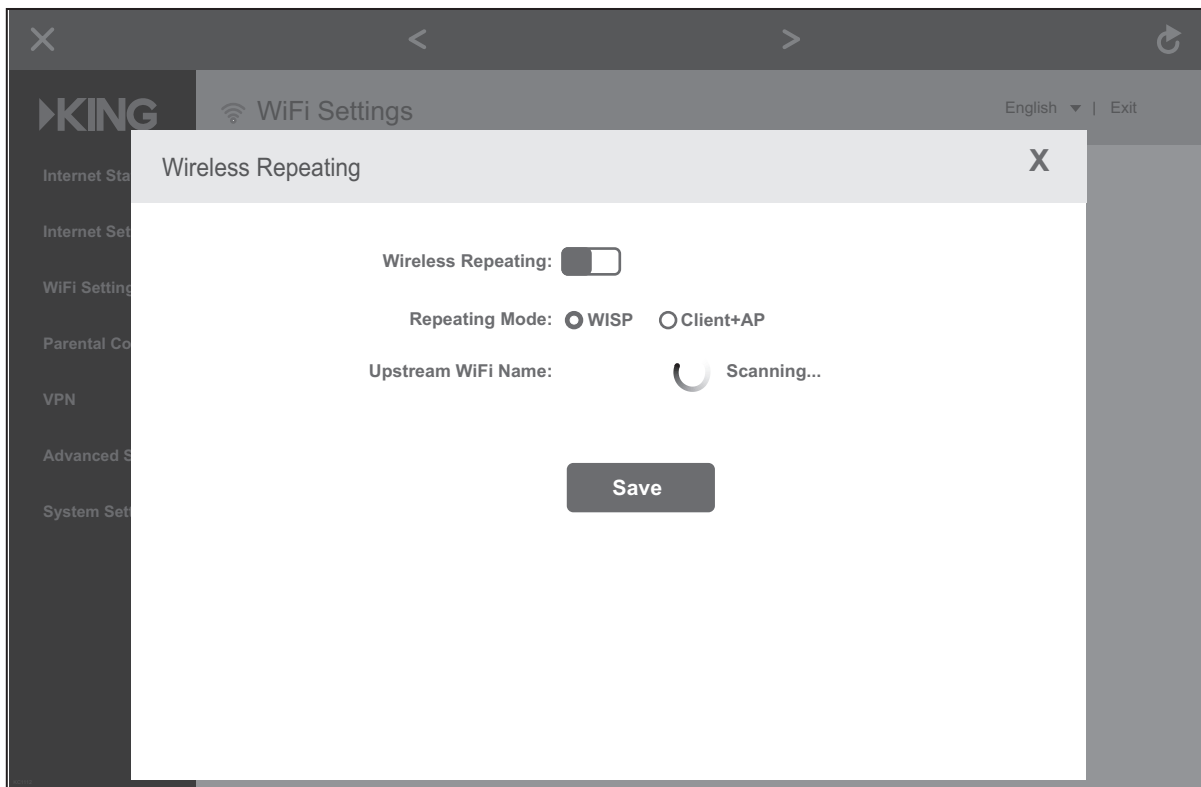

7. After the scanning process is complete, this screen should appear.

Tap the "Upstream WiFi Name" drop down menu to display a list of available networks.

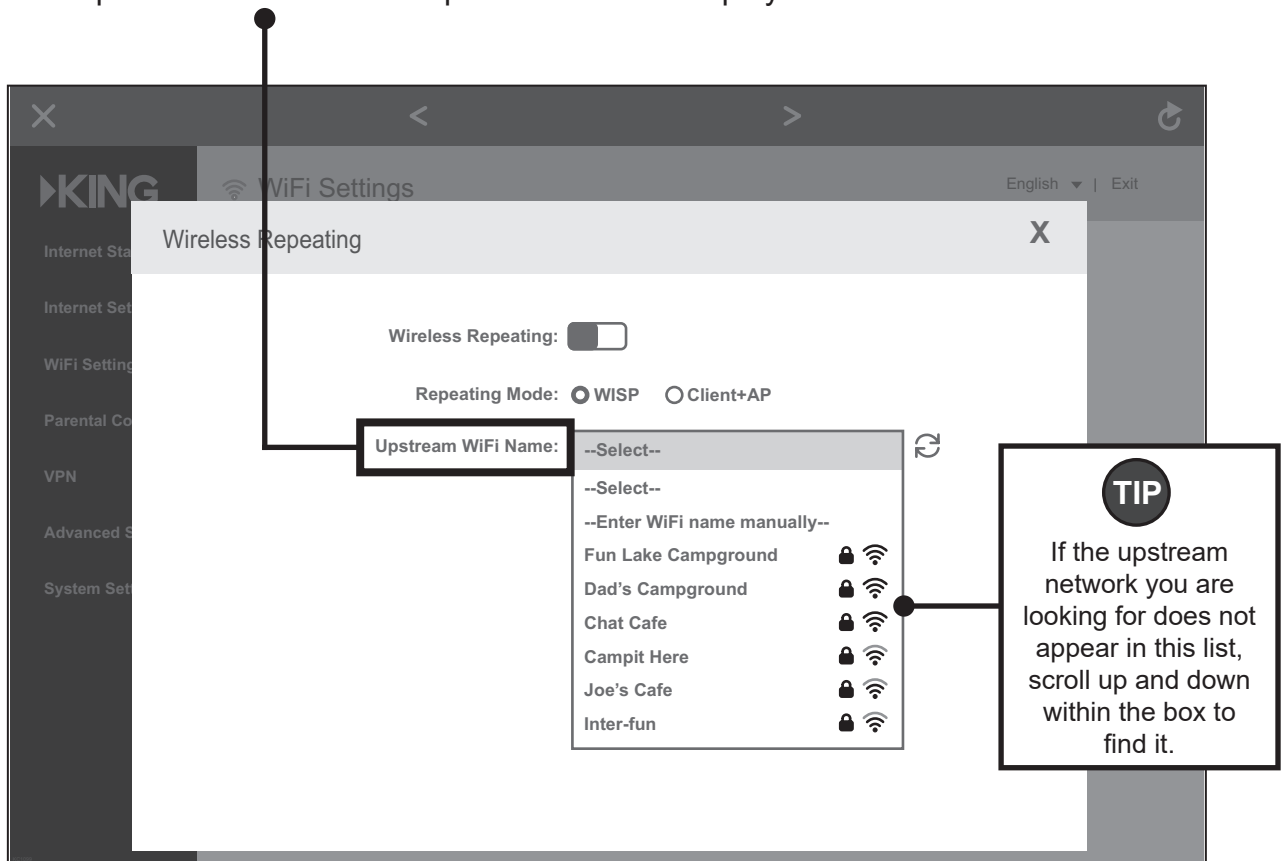

8. Select the same upstream network as the one you pointed the KING Falcon at (page 10, step 1).

Example:

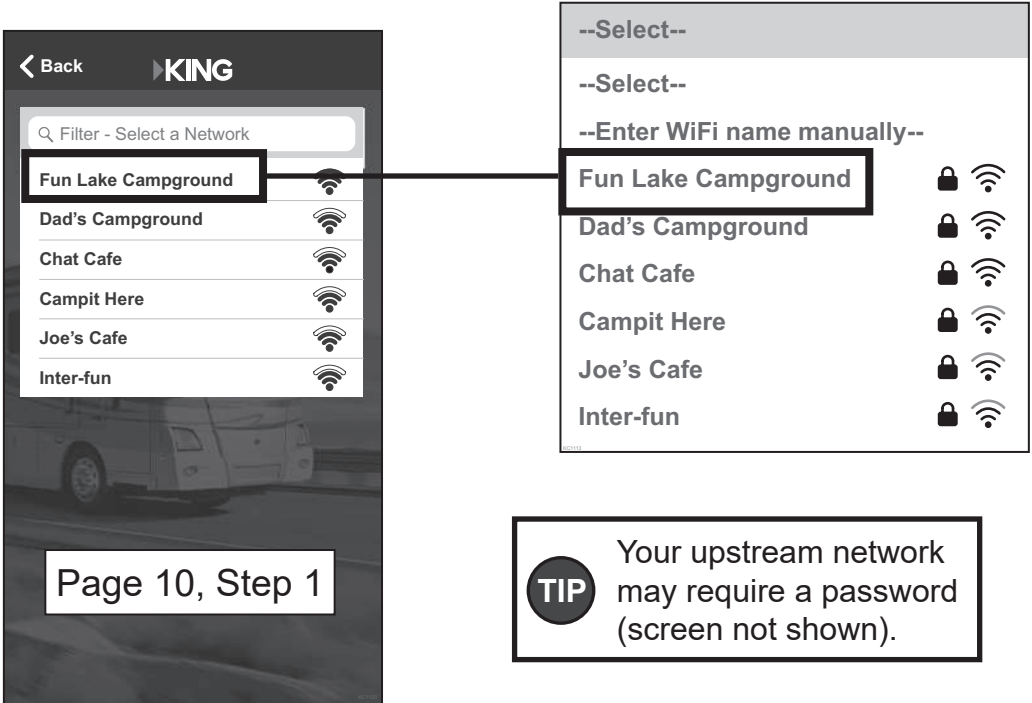

Page 10, Step 1

TIP Your upstream network may require a password (screen not shown).

9. Tap “Save.”

This popup should appear. Tap “OK.”

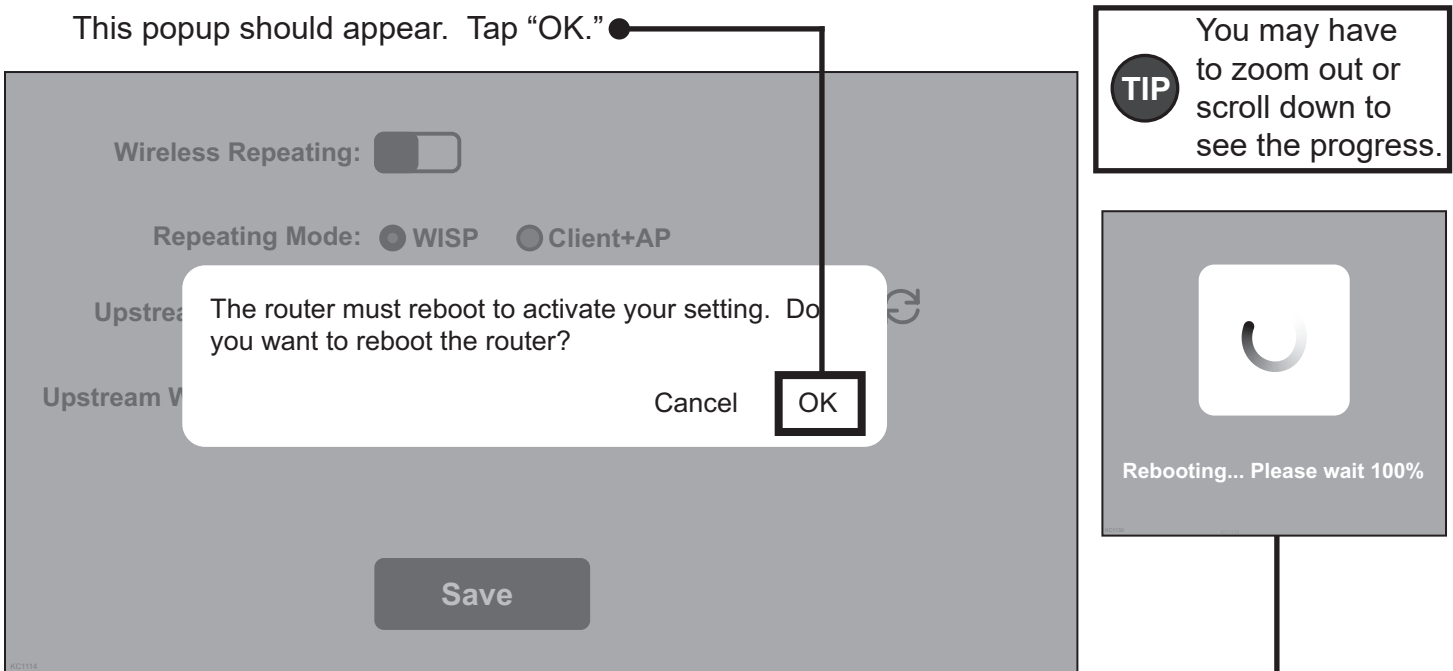

TIP You may have to zoom out or scroll down to see the progress.

Rebooting... Please wait 100%

10. Your KING WiFiMax will reboot.



If your router gets stuck at 100% and won't finish rebooting, or if your Wi-Fi device does not have internet access, you may need to go back to your smart phone or tablet's settings page and ensure that it reconnected to the Wi-Fi network with your personalized network name (page 5), as you may lose connection during the router's rebooting process.

Your KING WiFiMax is now extending your network!

TIP If you turned off your cellular network during this first-time setup, it is now safe to turn it back on.

This page intentionally left blank.

STANDARD OPERATION

TIP

To maintain the best connection to your KING WiFiMax, it is suggested that the cellular network on your smart phone or tablet be turned off while using standard operation.

1. Go to your smart phone or tablet's settings page and connect to the Wi-Fi Network with your personalized network name.

If your smart phone or tablet cannot connect to your 5GHz network, connect to your other network.

Example: ●

"MyWiFiName_5G"

This will be the name you created on page 5.



2. Open the KING Wi-Fi app and follow the instructions to either:

Start a rescan with the KING Falcon (for example you have moved and wish to scan for new networks) ●

OR

choose a list of previously scanned networks (for example your current choice of networks is currently unavailable and you wish to switch to an alternate one). ●

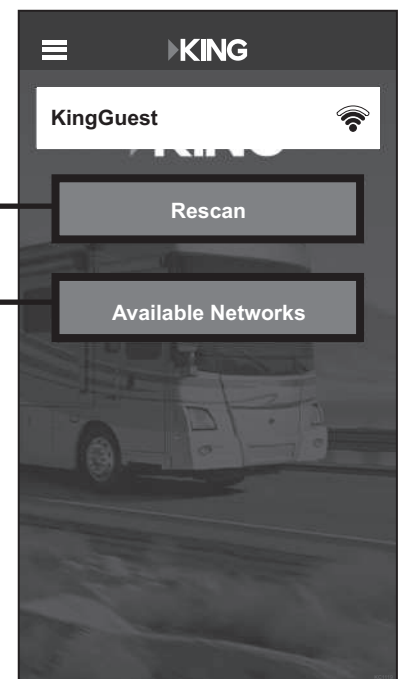

TIP

The "Available Network" button will not appear if:
Smart phone or tablet loses power.
KING Falcon antenna loses power.
Connection between KING Falcon and smart phone or tablet is lost.
App is closed.

3. Choose a network from the list generated by step 2.

Example: Fun Lake Campground

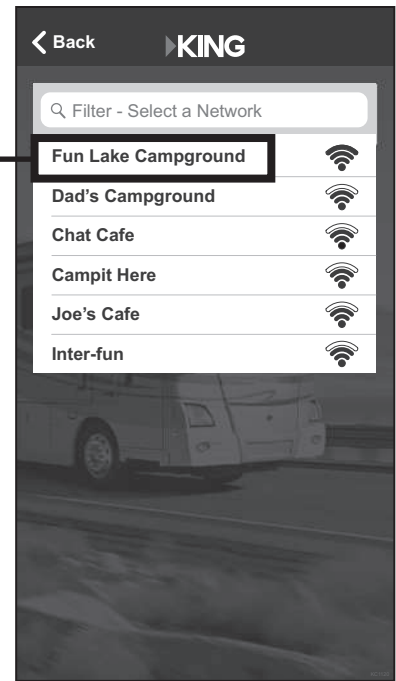

Do not select either of the 2.4GHz or 5GHz network names you created on page 5.

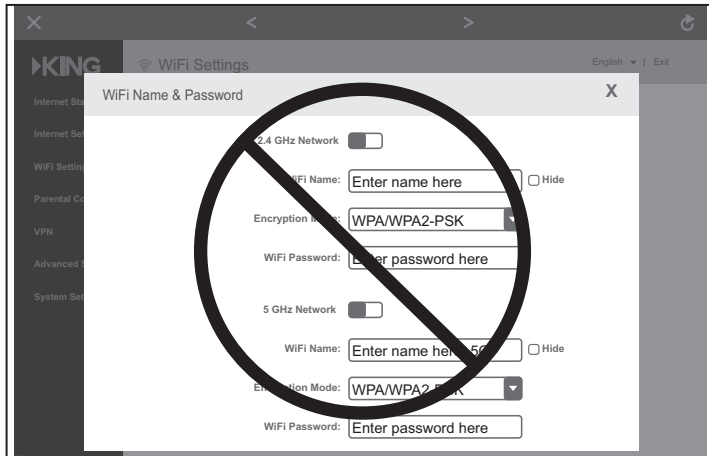

4. Follow the app instructions to locate the “KING WiFiMax Setup” screen (see page 11 if you don’t remember how to do this).

Tap on “KING WiFiMax Setup.”

5. Tap “WiFi Settings” in the left-hand column.

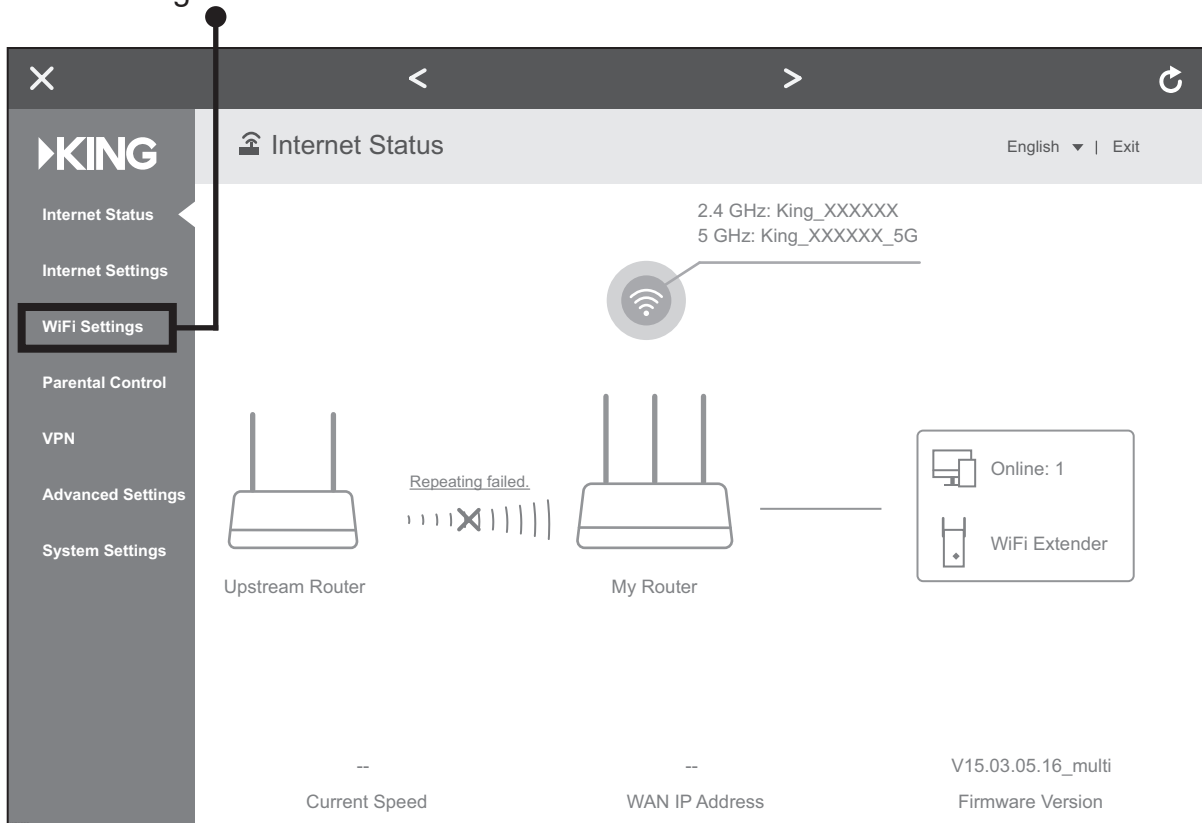

6. Tap “Wireless Repeating.”

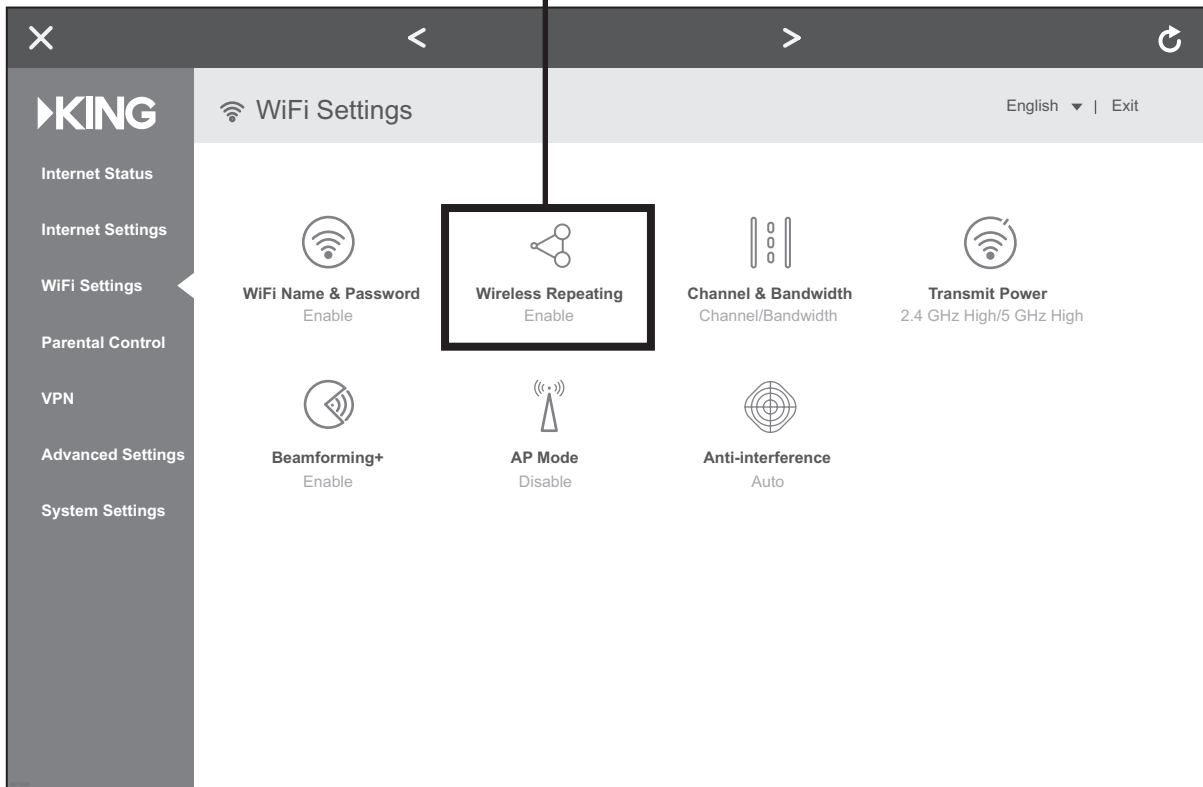

7. Tap the blue arrows to scan for networks.

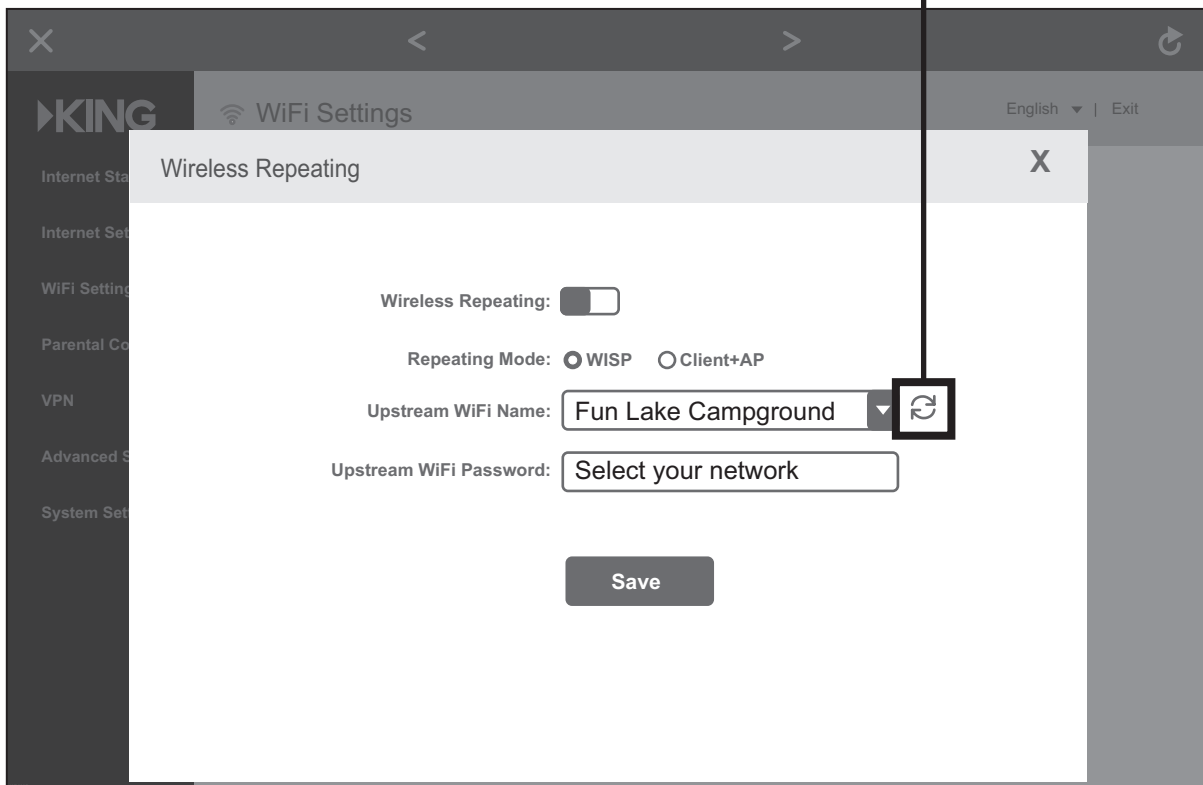

The router is scanning for networks.

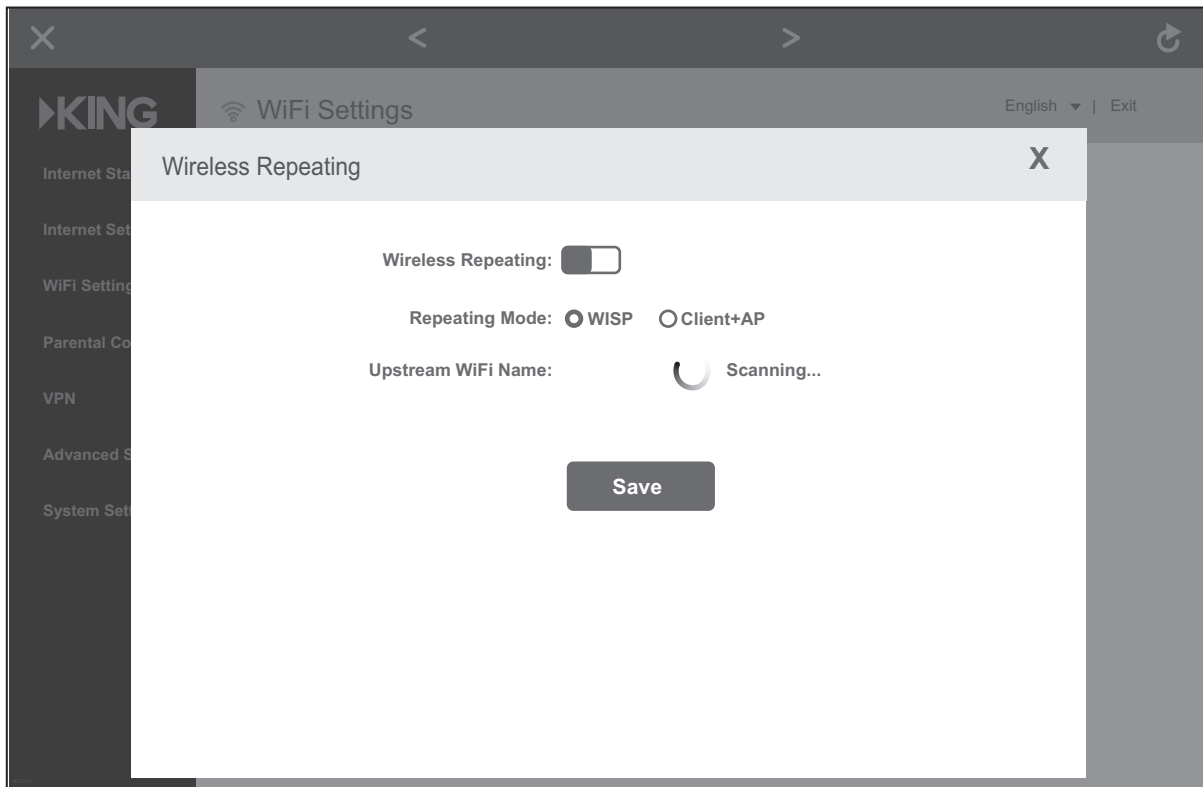

8. After the scanning process is complete, this screen should appear.

Tap the “Upstream WiFi Name” drop down menu to display a list of available networks.

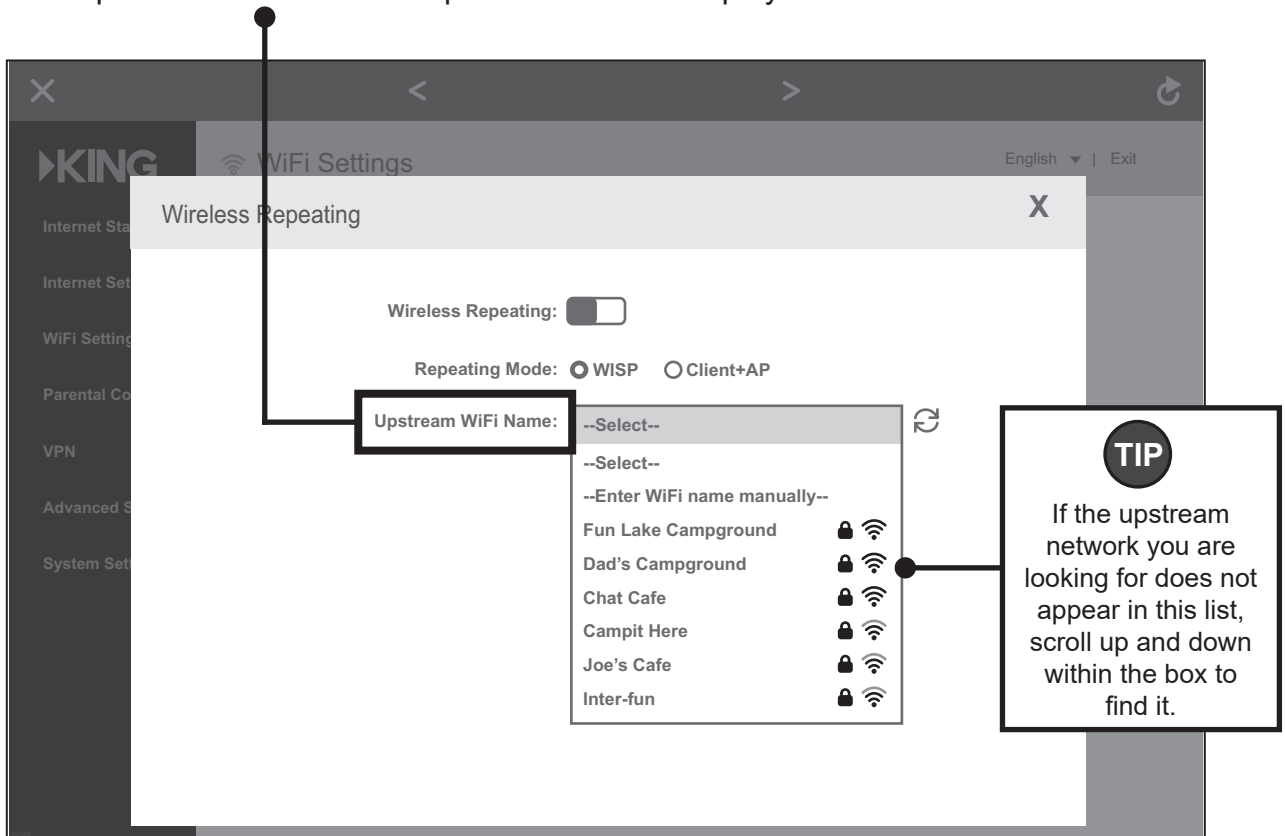

9. Select the same network as the one you pointed the KING Falcon at (page 17, step 3).

Example:

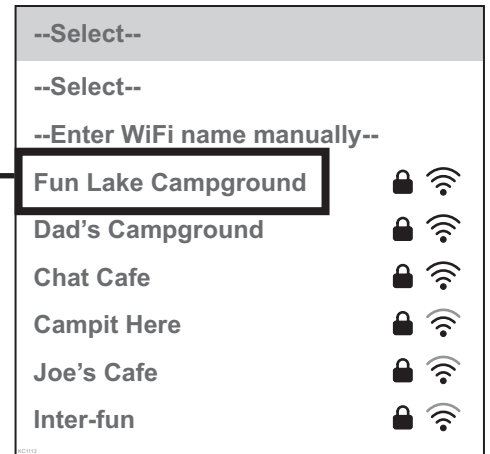
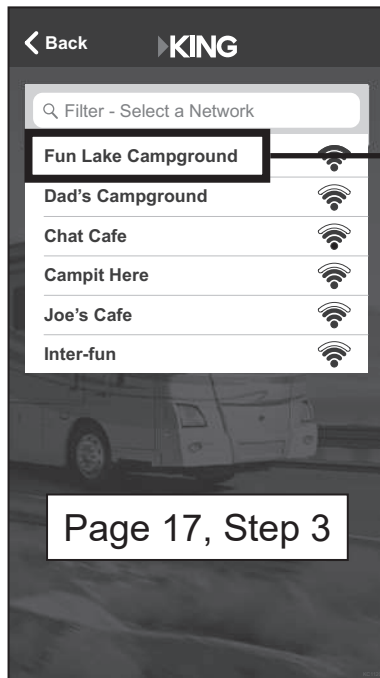

TIP Your upstream network may require a password (screen not shown).

Tap "Save."

This popup should appear. Tap "OK."

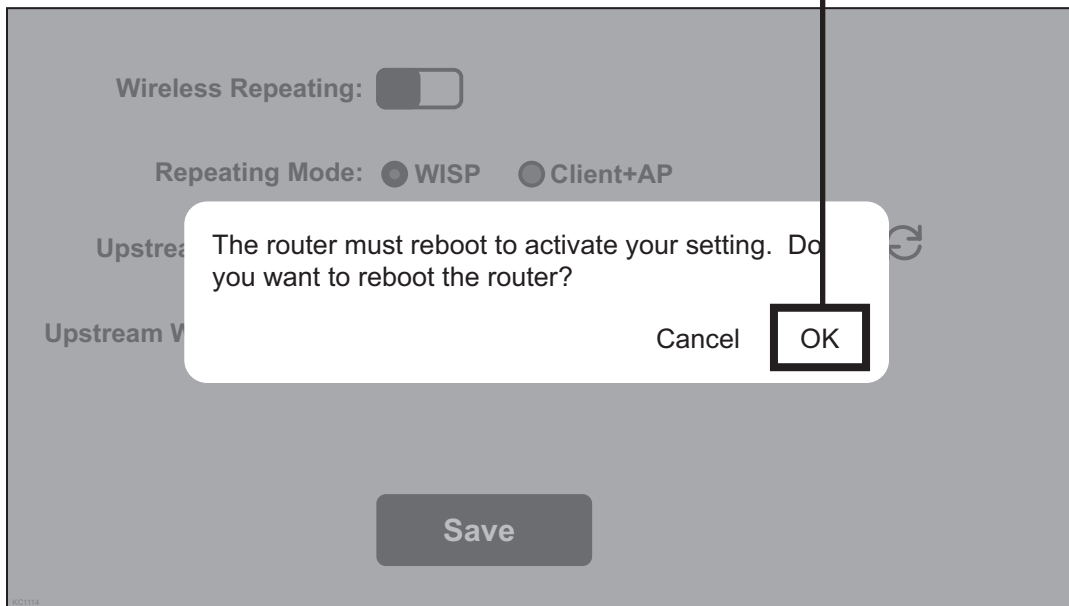

TIP You may have to zoom out or scroll down to see the progress.

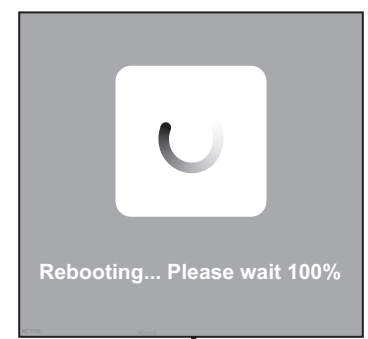

10. Your KING Wi-FiMax will reboot.



If your router gets stuck at 100% and won't finish rebooting, or if your Wi-Fi device does not have internet access, you may need to go back to your smart phone or tablet's settings page and ensure that it reconnected to the Wi-Fi network with your personalized network name (page 5), as you may lose connection during the router's rebooting process.

Your KING Wi-FiMax is now extending your network!

TIP If you turned off your cellular network during standard operation, it is now safe to turn it back on.

This page intentionally left blank.

INSTALLATION

TIP

Record KING Falcon serial number (located on back of base) on inside of cover before installing on roof.

CONTENTS

- KING Falcon antenna
- Power inserter with power supply
- Long exterior SMB cable
- Short interior RP-SMA cable
- White wall plate
- Black wall plate
- Installation and operating instructions
- KING WiFiMax router with power supply

IMPORTANT!

Appropriate fasteners and roof-compatible sealant to be determined and supplied by installer.

Read through the installation instructions before beginning. Determine the desired locations for the components using the information on these two pages. Locations will depend on such things as roof obstructions, cable runs between components, AC power availability and whether you will install the wall plates.

EXTERIOR

- For best performance, the antenna should be placed as far away from other rooftop objects (TV antennas, AC units, etc.) and with the best all around line of sight.
- The antenna should be mounted with the coax port towards the rear of the vehicle.
- There must be adequate space for the antenna head to rotate freely. The antenna should not rotate over other objects or rotate over the edge of the roof.

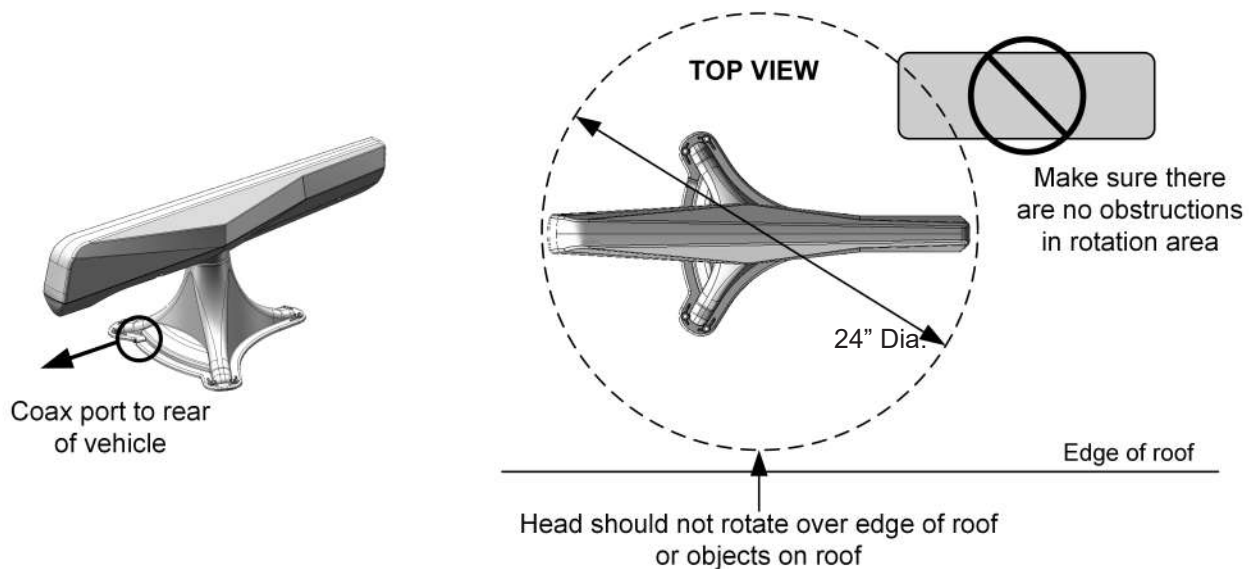

INTERIOR

- Do not locate interior components in a slide-out.
- Ensure supplied cables reach between components when placed in their installation locations.
- Ensure power inserter and KING WiFiMax router are located where their power supplies can be plugged into a 110 VAC outlet.
- The KING WiFiMax can be positioned on a stable surface or mounted to a wall.

EXTERIOR

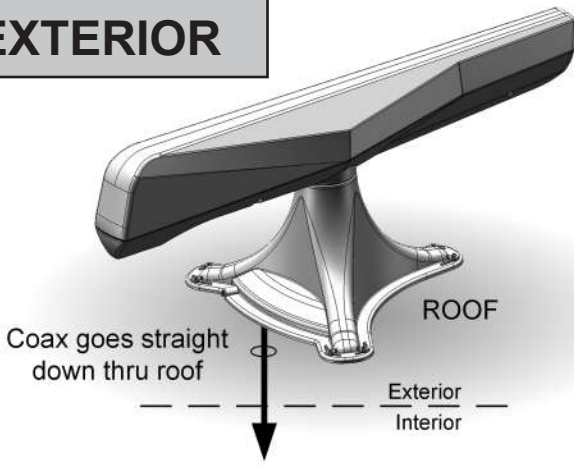

INSTALLATION OPTION 1: Concealed Cable (pages 24-25)

Coax enters vehicle directly under base mount.

OR

INSTALLATION OPTION 2: External Cable (pages 26-27)

Coax exits base mount in rear, is routed along roof, and enters vehicle outside of base mount perimeter.

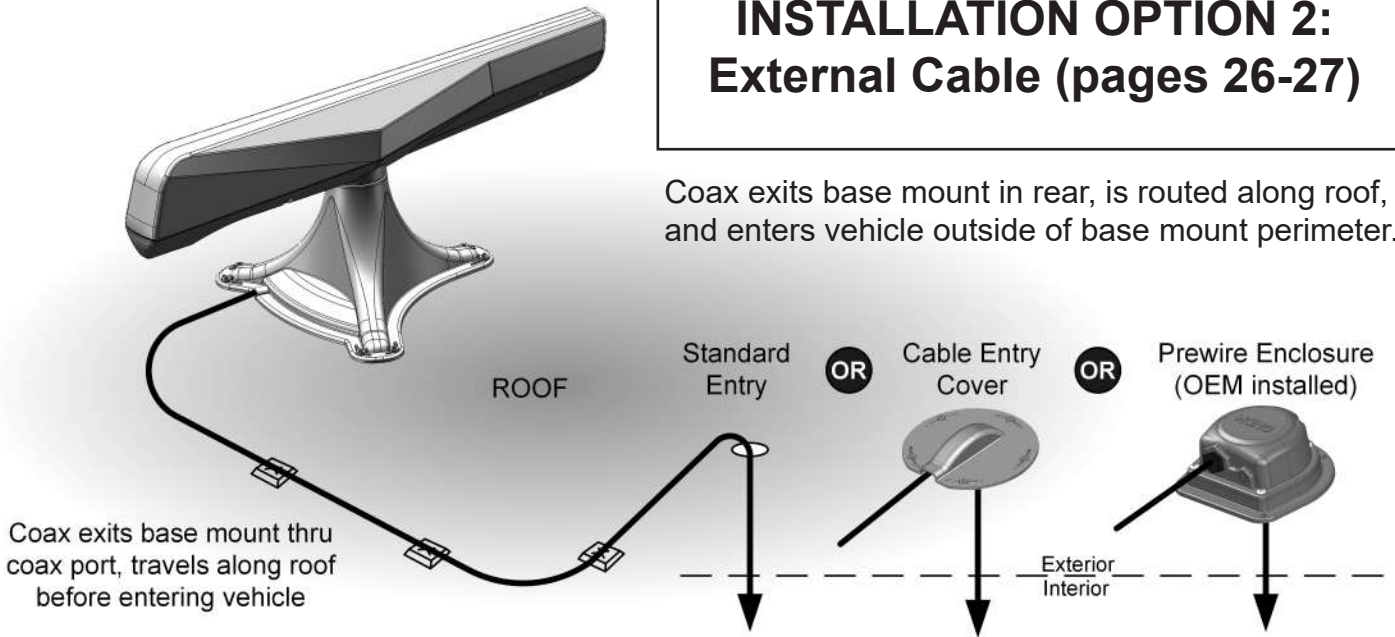

Coax exits base mount thru coax port, travels along roof before entering vehicle

INTERIOR

Connections are the same regardless of where coax enters vehicle (pages 28-29)

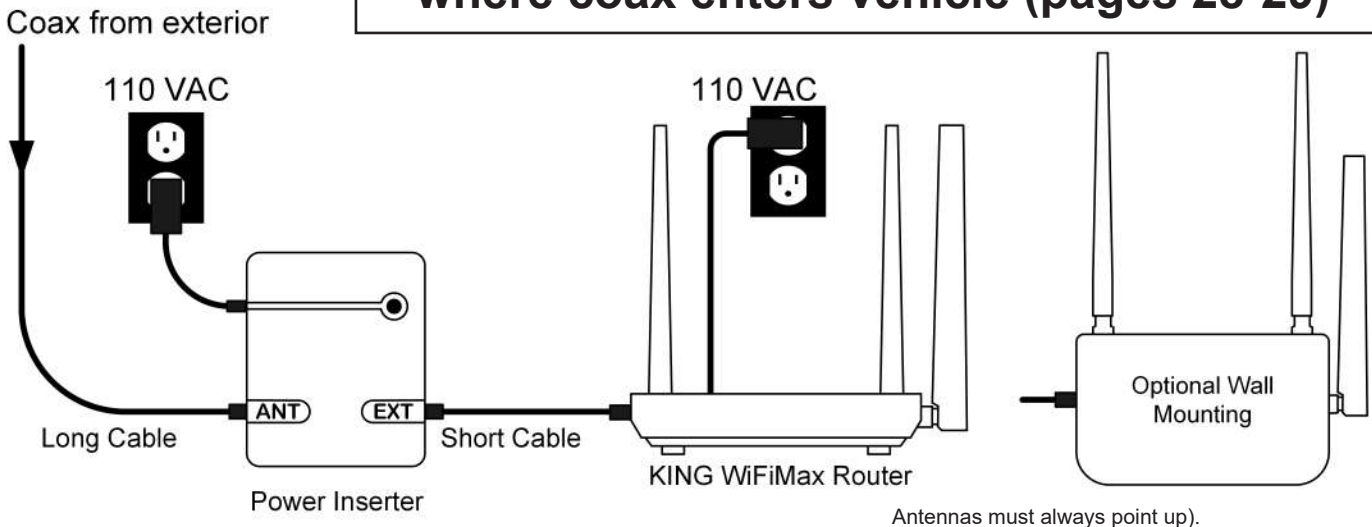

INSTALLATION OPTION 1: Concealed Cable

IMPORTANT! The installer is responsible for determining and supplying the most appropriate fasteners to secure the base mount to the roof.

All holes, fastener heads, and the entire perimeter of the base mount (including coax port) must be completely sealed and weatherproofed with roof-compatible sealant.

AVOID SHARP BENDS WHEN ROUTING CABLE!

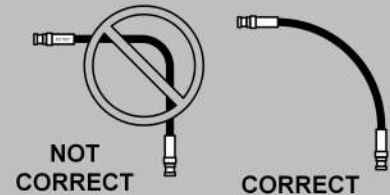

EXTERIOR

1. After establishing location of the antenna, drill a minimum 5/16" hole thru the roof where the cable will enter the vehicle. Make sure to locate hole so it is not covered by the circuit board when the antenna is set in place (Fig. 1).

IMPORTANT! The cables have different connectors on each end. Match the proper end of cables to the components before routing.

2. Feed the long cable thru the hole (from inside or outside) leaving about two feet sticking out of roof. Place all components and cables in position and make sure cables can reach all components.
3. **DO NOT TOUCH CIRCUIT BOARD AT ANY TIME!** Feed long cable under the circuit board as shown in the Fig. 2. Leave as large a bend as possible in the cable and push the cable connector onto the circuit board connector until it clicks in place (hold the cable by the connector and not the actual cable).
4. Fig. 3: Apply sealant around entire perimeter of base mount and fill coax port on rear of base mount.
5. Feed cable down thru roof hole as you lower the base mount into position.
6. Fasten base mount to roof with appropriate fasteners. Seal (6) fastener heads.

INTERIOR (Go to page 28)

INSTALLATION OPTION 1: Concealed Cable

FIG. 1

Locate roof hole next to coax port.

Hole must not be too close to circuit board.

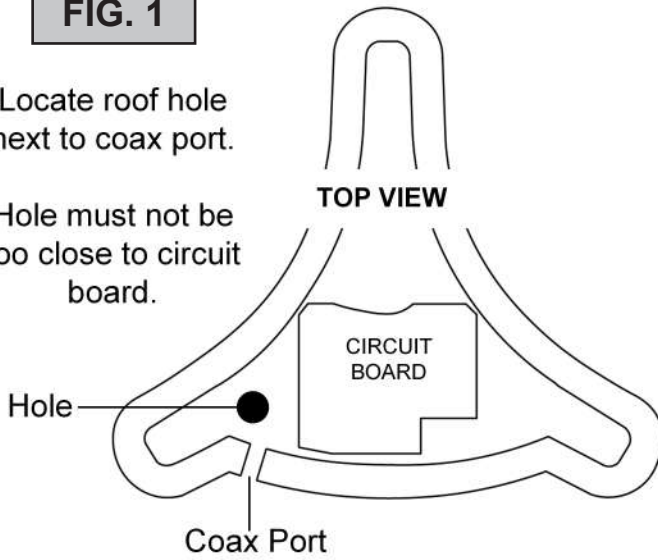

FIG. 2



KEEP BEND IN CABLE AS LARGE AS POSSIBLE!



FIG. 3

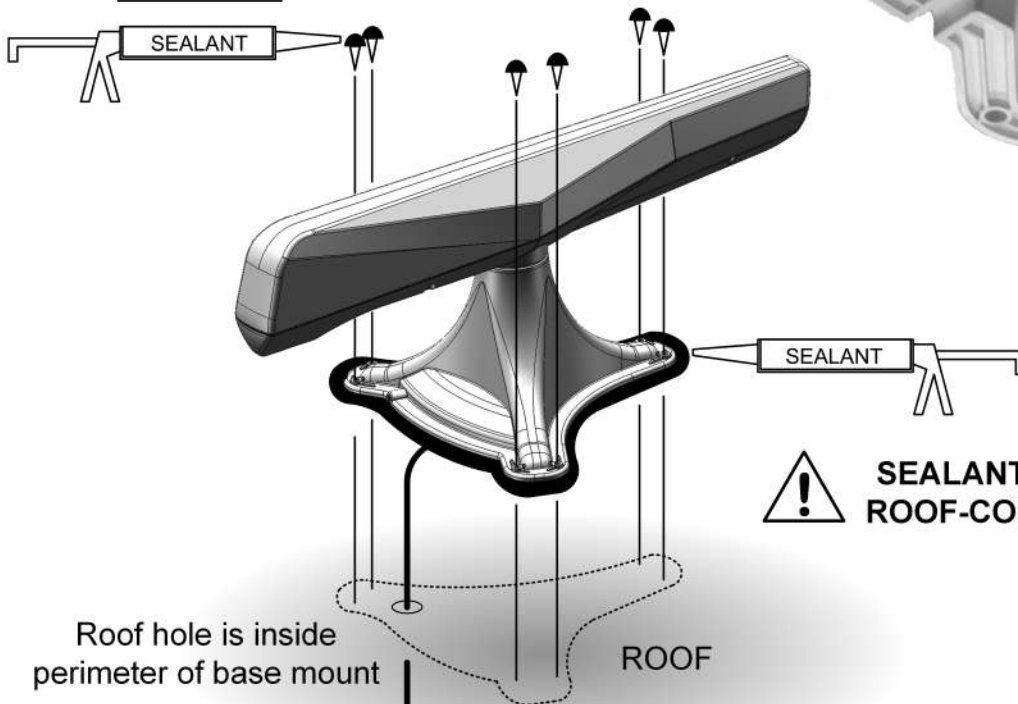

SEALANT MUST BE ROOF-COMPATIBLE!

Exterior
Interior

SEE PAGE 28



NO SHARP BENDS!

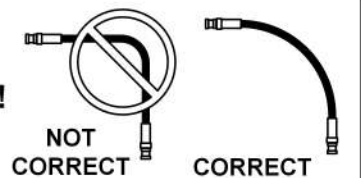

INSTALLATION OPTION 2: External Cable

IMPORTANT! The installer is responsible for determining and supplying the most appropriate fasteners to secure the base mount and coax to the roof.

All holes, fastener heads, and the entire perimeter of the base mount (including coax port) must be completely sealed and weatherproofed with roof-compatible sealant.

AVOID SHARP BENDS WHEN ROUTING CABLE!

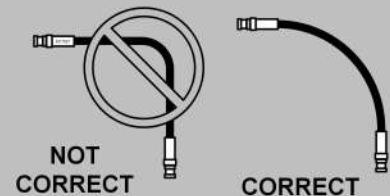

EXTERIOR

IMPORTANT! The cables have different connectors on each end. Match the proper end of cables to the components before routing.
If using the prewire enclosure, you will not do steps 1, 2 and 7 (see Fig. 3).

1. Drill a minimum 5/16" hole where cable will go thru roof.
2. Feed the long cable thru the hole (from inside or outside) Place all components and cables in position, leaving enough cable sticking out of roof to reach both antenna (outside) and power inserter (inside).
3. **DO NOT TOUCH CIRCUIT BOARD AT ANY TIME!** Feed cable under the circuit board as shown in the Fig. 1. Leave as large a bend as possible in the cable and push the cable connector onto the circuit board connector until it clicks in place (hold the cable by the connector and not the actual cable).
4. Fig. 2. Apply sealant around entire perimeter of base mount and fill coax port on rear of base mount. Make sure you fill coax port with sealant before placing cable in it to ensure complete sealing of coax port.
5. Place cable in coax port and place the base mount in position.
DO NOT PINCH COAX UNDER EDGE OF BASE MOUNT WHEN PLACING ON ROOF.
6. Fasten base mount to roof with appropriate fasteners. Seal (6) fastener heads.
7. Seal roof hole so it is completely waterproof (the optional cable entry cover provides additional protection for the cable entry point - see your dealer or *kingconnect.com*).
8. Fasten cable to roof every 12-18" (hardware determined and supplied by installer).

INTERIOR (Go to page 28)

INSTALLATION OPTION 2: External Cable

FIG. 2

SEALANT MUST BE ROOF-COMPATIBLE!

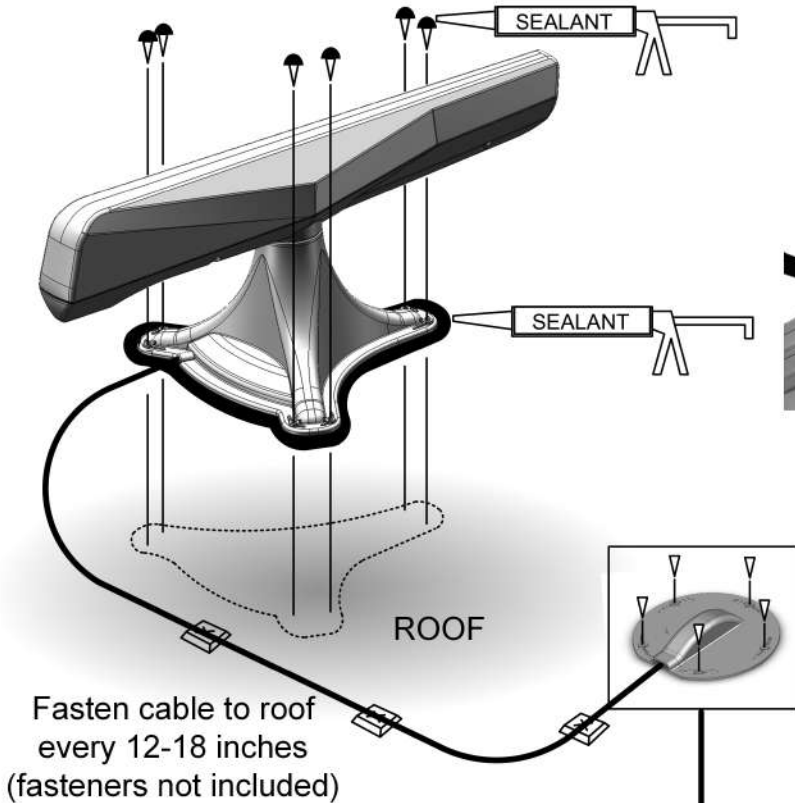
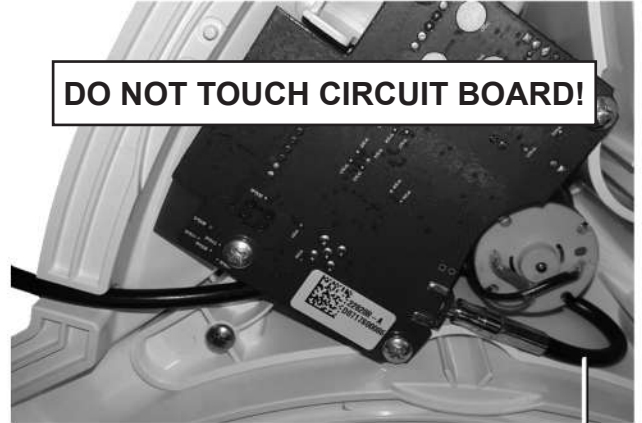
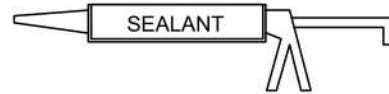

FIG. 1

Cable exits base mount towards rear of vehicle and is routed to entry point



KEEP BEND IN CABLE AS LARGE AS POSSIBLE!



Optional Cable Entry Cover shown (see satellite accessories page on KING website)

Exterior
Interior

SEE PAGE 28

FIG. 3

Prewire connections with OEM installed prewire enclosure

1. Remove (4) screws and take off the prewire cap.
2. Knock out the hole for the watertight connector.
3. Take the nut off the watertight connector.
4. Feed the cable through the nut, prewire cap, and connector.
5. Install the connector in the prewire cap with the nut.
6. Feed desired amount of cable through connector and tighten the connector's sealing nut.
7. Replace the prewire cap and fasten with (4) screws.
DO NOT OVER-TIGHTEN SCREWS INTO PLASTIC.

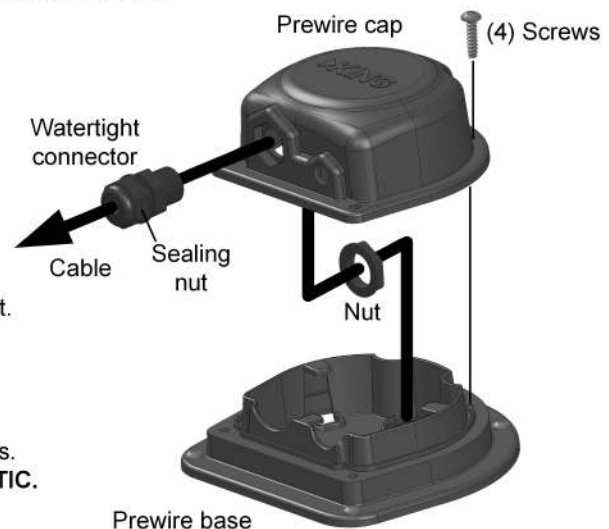

INTERIOR CONNECTIONS

1. Make connections as shown (install wall plate if desired).
2. Rotate 3 antennas into upright position (antennas must always point up whether the KING WiFiMax is placed on a flat surface or wall mounted).
3. Plug in power inserter and KING WiFiMax.

NOTE: You can wall mount the KING WiFiMax using the keyhole slots in the back. Always point the antennas up.

INTERIOR CONNECTIONS



ANTENNAS MUST ALWAYS POINT UP!

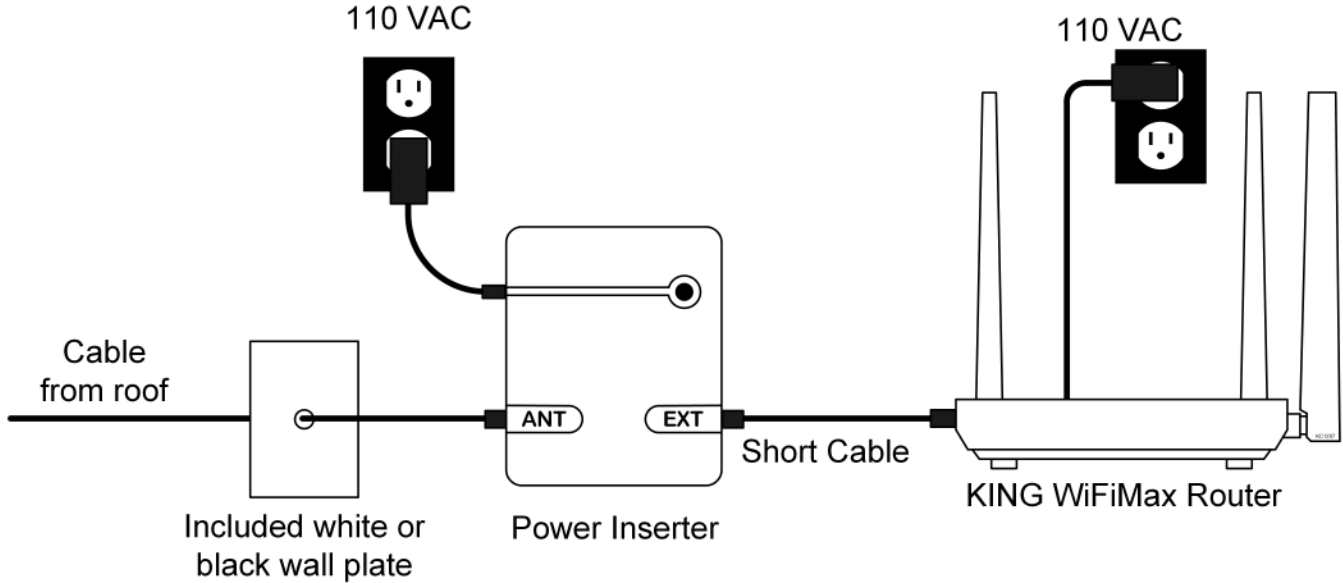

If there is a prewire enclosure on the roof, you will find a preinstalled wall plate. Remove this plate and replace it with the included white or black wall plate.

Optional Wall Mounting



ANTENNAS MUST ALWAYS POINT UP!

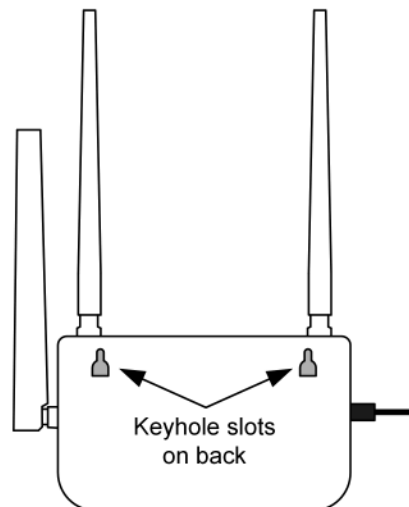

TROUBLESHOOTING

The KING WiFiMax doesn't power on (no blue lights on front).

Make sure power supply plug is securely inserted into back of KING WiFiMax. Make sure the power supply is plugged into a known good power outlet.

I can't find the network KING_XXXXXX_5G or KING_XXXXXX.

Make sure your KING WiFiMax is plugged in. It may take up to a minute for these networks to appear. Some older devices may be unable to see the 5GHz network. This is completely okay; just use the KING_XXXXXX network.

I can't access the KING WiFiMax setup screen.

Go to your smart phone or tablet's settings page and make sure you are connected to your KING WiFiMax's network.

I can't enter a password in the designated box.

Choose WPA/WPA2-PSK under "Encryption Mode" (right above the password box) to enable password protection.

When I tap on Upstream WiFi Name I don't see the network I want in the list of networks.

If there are more networks in the list than can appear in the box, you will need to scroll up or down in the box to see them all.

If a network is very far away or very weak, the KING WiFiMax may not be able to see it, or may not offer it as an option. Try scanning again for networks by clicking on the blue circular arrows. If your network is still not offered as an option, try moving your KING WiFiMax to a location closer to your desired network.

When my router reboots, it gets stuck at 100% and won't finish rebooting.

Try reloading the page. (If the page won't load, make sure your device is still connected to the KING WiFiMax. It may have disconnected during the reboot.)

The KING WiFiMax doesn't seem to extend the range of my Wi-Fi, or has trouble picking up signal from my source.

Make sure all 3 antennas are pointing up. If wall mounting, antennas must be rotated to point up (or down) as well.

Certain types of obstructions (other vehicles, buildings, or large amounts of metal) can reduce signal levels. Try relocating the KING WiFiMax.

NOTE: KING WiFiMax can be reset by pressing and holding the reset button until the front lights go out (15-20 seconds).

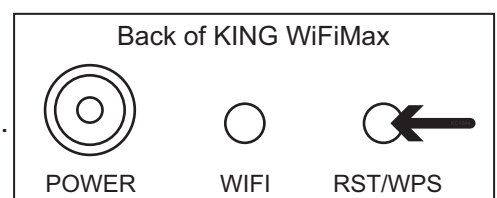

Let us help! KING Customer Service 952-345-8147

SPECIFICATIONS

KING FALCON ANTENNA SPECIFICATIONS

Antenna:	Antenna Weight: 2.7 lbs. Antenna Dimensions: 9.18" H x 10.95" W x 22.65" L
Wireless Standards:	IEEE 802.11b IEEE 802.11g IEEE 802.11n
Radio Frequency Band:	2.4GHz
Antennas:	(1) 15dBi Yagi-type Antenna (Self-Aiming, Internal, iOS or Android Controlled) (1) Internal Bluetooth Low Energy Antenna
Amplifiers:	(1) 2.4 GHz Radio Power Amplifier for Bluetooth LE
Antenna Connector Type:	(1) RP-SMA to Connect Indoor Wall Plate to Wi-Fi Extender
Power Supply Rating:	Input: Voltage: 12VDC Nominal, 16VDC Max. Current: 500mA Max
Setup Requirements:	Tablet, Smartphone, or similar device with Bluetooth Low Energy Capability running Apple iOS or Android

KING WIFIMAX ROUTER SPECIFICATIONS

Power:	Included 12v power supply, requiring 110V AC plug-in
Wireless standards:	IEEE802.11a/b/g/n/ac
Supported Frequencies:	2.4GHz and 5GHz (dual-band)
Security:	WPA/WPA2-PSK
Storage Environment:	Temperature -40°F to 158°F

IMPORTANT! Do not power wash any part of the KING Falcon antenna head or base mount.

LIMITED WARRANTY

Every new KING Falcon/KING WiFiMax is thoroughly inspected and tested before leaving the factory, and is covered by the following limited warranty from the date of original purchase:

- KING Falcon
- Two-year parts warranty: The customer is not responsible for the cost of replacement parts if the original part is determined to be defective under the terms of the warranty. The customer is responsible for the cost of replacement parts after two years.
 - One-year labor warranty: The customer is not responsible for labor costs to repair unit if unit falls under the terms of the warranty. Any warranty labor outside of that performed at the factory is not covered unless the product has been installed by an authorized dealer/installer or OEM manufacturer. The customer is responsible for all labor costs after one year.
- KING WiFiMax
- One-year parts warranty: The customer is not responsible for the cost of replacement parts if the original part is determined to be defective under the terms of the warranty. The customer is responsible for the cost of replacement parts after one year.

Only KING and certified dealers may perform warranty evaluations and repairs. Depending upon the problem, KING may authorize a dealer to perform the necessary repairs. Any warranty labor outside of that performed at the factory is not covered unless 1) the product has been installed by an authorized dealer/installer or OEM manufacturer and 2) the dealer/installer receives prior authorization to perform the repair.

A certified dealer must not perform any repair without first contacting KING for a Service Order Number. KING will advise the dealer on how to proceed with any repairs.

Should any trouble develop during the warranty period, contact KING at (952) 345-8147. You must contact KING before the warranty period expires. The customer must supply proof of purchase (such as a dated sales receipt) when requesting warranty service. If the customer cannot supply proof of purchase, warranty period shall start 30 days after date of manufacture.

If it is determined that the unit needs to be returned to KING, customer must return COMPLETE product, freight prepaid, to:
KING, 11200 Hampshire Avenue South, Bloomington, MN 55438-2453.

If inspection shows the trouble is caused by defective workmanship or material, KING will repair (or at its option, replace) without charge.

When returning product, KING will supply an RMA number (Return Merchandise Authorization). This number must be clearly written on the box. Failure to clearly write RMA number on box may result in delays in processing claim. Along with product, customer should include in the box: his/her name, address, daytime phone number, proof of purchase and description of the problem.

This warranty does not cover installation and external wiring, or remanufactured units. This warranty does not cover damage caused by the use of an accessory other than a KING accessory designed for the product. This warranty is not transferable from the original owner.

KING cannot be held responsible for changes in the expanding and changing digital and analog communications market that cause the product to no longer operate correctly.

This warranty also does not apply where:

- The product has been abused, misused, improperly installed or improperly maintained.
- The product has been used with an accessory other than a KING accessory designed for the product.
- Repairs have been made or attempted by others that are not certified by KING to do such repairs.
- Repairs are required because of normal wear and tear.
- Alterations have been made to the product.
- The product or any associated component has been opened without authorization or disassembled to any degree.
- Damage has been caused by power washing.
- Circumstances beyond the control of KING cause the product to no longer operate correctly.
- Customer is not the original owner.

In no event shall KING be liable for any indirect, incidental, or consequential damages from the sale or use of the product. This disclaimer applies both during and after the term of this warranty.

KING disclaims liability for any implied warranties, including implied warranties of “merchantability” and “fitness for a specific purpose,” after the term of this warranty.

This warranty gives you specific legal rights, and you may also have other rights, which vary from state to state. Some states do not allow the exclusion or limitation of incidental or consequential damages, so the above limitation or exclusion may not apply to you. Some states do not allow limitations on how long an implied warranty lasts, so the above limitation may not apply to you.

WIRELESS REGULATORY INFORMATION

FCC Statement

This device complies with part 15 of the FCC Rules. Operation is subject to the following two conditions: (1) This device may not cause harmful interference, and (2) this device must accept any interference received, including interference that may cause undesired operation.

Note: This equipment has been tested and found to comply with the limits for a Class B digital device, pursuant to part 15 of the FCC Rules. These limits are designed to provide reasonable protection against harmful interference in a residential installation. This equipment generates, uses and can radiate radio frequency energy and, if not installed and used in accordance with the instructions, may cause harmful interference to radio communications. However, there is no guarantee that interference will not occur in a particular installation. If this equipment does cause harmful interference to radio or television reception, which can be determined by turning the equipment off and on, the user is encouraged to try to correct the interference by one or more of the following measures:

- Reorient or relocate the receiving antenna.
- Increase the separation between the equipment and receiver.
- Connect the equipment into an outlet on a circuit different from that to which the receiver is connected.
- Consult the dealer or an experienced radio/TV technician for help.

FCC Caution

Any changes or modifications not expressly approved by the party responsible for compliance could void the user's authority to operate this equipment.

This transmitter must not be co-located or operating in conjunction with any other antenna or transmitter.

IEEE 802.11b or 802.11g operation of this product in the USA is firmware-limited to channels 1 through 11.

The device for the band 5150-5250 MHz is only for indoor usage to reduce the potential for harmful interference to co-channel mobile satellite systems.

Radiation Exposure Statement

This device complies with FCC radiation exposure limits set forth for an uncontrolled environment and it also complies with Part 15 of the FCC RF Rules. This equipment should be installed and operated with minimum distance 20 cm between the radiator and your body.

Innovation, Science and Economic Development Canada Statement

CAN ICES-3 (B)/NMB-3(B)

This device contains licence-exempt transmitter(s)/receiver(s) that comply with Innovation, Science and Economic Development Canada's licence-exempt RSS(s). Operation is subject to the following two conditions: (1) This device may not cause interference, and (2) This device must accept any interference, including interference that may cause undesired operation of the device.

For product available in the USA/Canada market, only channel 1-11 can be operated. Selection of other channels is not possible.

The device could automatically discontinue transmission in case of absence of information to transmit, or operational failure. Note that this is not intended to prohibit transmission of control or signaling information or the use of repetitive codes where required by the technology.

Innovation, Science and Economic Development Canada Radiation Exposure Statement

This equipment complies with ISED radiation exposure limits set forth for an uncontrolled environment. This equipment should be installed and operated with minimum distance 20 cm between the radiator and your body.

This device and its antenna(s) must not be co-located or operating in conjunction with any other antenna or transmitter except in accordance with ISED multi-transmitter product procedures.

Restrictions in the 5 GHz Band

The device for the band 5150-5250 MHz is only for indoor usage to reduce the potential for harmful interference to co-channel mobile satellite systems.

The maximum antenna gain permitted for devices in the band 5725-5825 MHz shall comply with the e.i.r.p. limits specified for point-to-point and non point-to-point operation as appropriate.

Users should also be advised that high-power radars are allocated as primary users (i.e. priority users) of the bands 5250-5350 MHz and 5650-5850 MHz and that these radars could cause interference and/or damage to LE-LAN devices.

This radio transmitter (6873A-KWM1000) has been approved by Innovation, Science and Economic Development Canada to operate with the antenna types listed below with the maximum permissible gain indicated. Antenna types not included in this list that have a gain greater than the maximum gain indicated for any type listed are strictly prohibited for use with this device.

Detachable antenna:

- 5 dBi at 2.4 GHz, 50Ω, Dipole
- 8.48 dBi at 2.4 GHz, 50Ω, Yagi

Additional requirements for the band 5600-5650 MHz

Until further notice, devices subject to this Section shall not be capable of transmitting in the band 5600-5650 MHz, so that Environment Canada weather radars operating in this band are protected.

Avis d'Innovation, Sciences et Développement économique Canada

CAN ICES-3 (B)/NMB-3(B)

L'émetteur/récepteur exempt de licence contenu dans le présent appareil est conforme aux CNR d'Innovation, Sciences et Développement économique Canada applicables aux appareils radio exempts de licence. L'exploitation est autorisée aux deux conditions suivantes : (1) L'appareil ne doit pas produire de brouillage; et (2) L'appareil doit accepter tout brouillage radioélectrique subi, même si le brouillage est susceptible d'en compromettre le fonctionnement.

Pour les produits disponibles sur le marché aux États-Unis et au Canada, seuls les canaux de 1 à 11 peuvent être utilisés. La sélection d'autres canaux n'est pas possible.

Le dispositif peut automatiquement cesser d'émettre en cas d'absence d'informations à transmettre, ou à cause d'une défaillance technique. Notez que l'objet n'est pas d'interdire la transmission des informations de contrôle ou de signalisation ou l'utilisation de codes répétitifs lorsque requis par la technologie.

Avis d'Innovation, Sciences et Développement économique Canada concernant l'exposition aux radiofréquences

Ce matériel est conforme aux limites établies par ISED en matière d'exposition aux radiofréquences dans un environnement non contrôlé. Ce matériel doit être installé et utilisé à une distance d'au moins 20 cm entre l'antenne et le corps de l'utilisateur.

Cet appareil et son (ses) antenne(s) ne doivent pas être situés à proximité ou fonctionner en association avec une autre antenne ou un autre émetteur autre qu'en respectant les procédures d'ISED relatives au fonctionnement des dispositifs multi-émetteurs.

Restrictions dans la bande 5 GHz

L'appareil pour la bande de 5150 à 5250 MHz est conçu pour usage à l'intérieur seulement afin de réduire le potentiel d'interférences pour les systèmes mobiles par satellite qui utilisent le même canal.

Le gain maximal d'antenne permis (pour les dispositifs utilisant la bande 5725-5825 MHz) doit se conformer à la limite de p.i.r.e. spécifiée pour l'exploitation point à point et non point à point, selon le cas.

De plus, les utilisateurs devraient aussi être avisés que les utilisateurs de radars de haute puissance sont désignés utilisateurs principaux (c.-à-d., qu'ils ont la priorité) pour les bandes 5250-5350 MHz et 5650-5850 MHz et que ces radars pourraient causer du brouillage et/ou des dommages aux dispositifs LAN-EL.

Le présent émetteur radio (6873A-KWM1000) a été approuvé par Innovation, Sciences et Développement économique Canada pour fonctionner avec les types d'antenne énumérés ci-dessous et ayant un gain admissible maximal. Les types d'antenne non inclus dans cette liste, et dont le gain est supérieur au gain maximal indiqué pour tout type figurant sur la liste, sont strictement interdits pour l'exploitation de l'émetteur.

Antenne détachable:

- 5 dBi à 2.4 GHz, 50Ω, Dipôle
- 8.48 dBi à 2.4 GHz, 50Ω, Yagi

Prescriptions supplémentaires pour la bande 5600-5650 MHz

Jusqu'à nouvel ordre, les appareils faisant l'objet de la présente section ne doivent pas transmettre dans la bande 5600-5650 MHz, afin que les radars météorologiques d'Environnement Canada fonctionnant dans cette bande soient protégés.

Simply better, by design.™



11200 Hampshire Avenue South, Bloomington, MN 55438
PH 952.922.6889 || FAX 952.922.8424 || kingconnect.com

© 2020 KING 22872 Rev E

All trademarks are the sole property of their respective owners.