

# VG

# 208

# 208-2



Scan the QR code to go and  
subscribe our tutorial channel

**vtech<sup>®</sup>**

# User's manual

## Congratulations

on purchasing your new VTech product. Before using this telephone, please read Important safety instructions.

This manual has all the feature operations and troubleshooting necessary to install and operate your new VTech telephone. Please review this manual thoroughly to ensure proper installation and operation of this innovative and feature rich VTech product.

For support, shopping, and everything new at VTech, visit our website at [www.vtechphones.com](http://www.vtechphones.com). In Canada, please visit [phones.vtechcanada.com](http://phones.vtechcanada.com).



Telephones identified with this logo have reduced noise and interference when used with most T-coil equipped hearing aids and cochlear implants. The TIA-1083 Compliant Logo is a trademark of the Telecommunications Industry Association. Used under license.



The ENERGY STAR® program ([www.energystar.gov](http://www.energystar.gov)) recognizes and encourages the use of products that save energy and help protect our environment. We are proud to mark this product with the ENERGY STAR® label indicating it meets the latest energy efficiency guidelines.



## Important safety instructions

When using your telephone equipment, basic safety precautions should always be followed to reduce the risk of fire, electric shock and injury, including the following:

1. Read and understand all instructions.
2. Follow all warnings and instructions marked on the product.
3. Unplug this product from the wall outlet before cleaning. Do not use liquid or aerosol cleaners. Use a damp cloth for cleaning.
4. CAUTION: Do not install the telephone base at a height above 2 meters.
5. Do not use this product near water such as near a bath tub, wash bowl, kitchen sink, laundry tub or a swimming pool, or in a wet basement or shower.
6. Do not place this product on an unstable table, shelf, stand or other unstable surfaces.
7. Avoid placing the telephone system in places with extreme temperature, direct sunlight, or other electrical devices. Protect your phone from moisture, dust, corrosive liquids and fumes.
8. Slots and openings in the back or bottom of the telephone base and handset are provided for ventilation. To protect them from overheating, these openings must not be blocked by placing the product on a soft surface such as a bed, sofa or rug. This product should never be placed near or over a radiator or heat register. This product should not be placed in any area where proper ventilation is not provided.
9. This product should be operated only from the type of power source indicated on the marking label. If you are not sure of the type of power supply in your home or office, consult your dealer or local power company.
10. Do not allow anything to rest on the power cord. Do not install this product where the cord may be walked on.
11. Never push objects of any kind into this product through the slots in the telephone base or handset because they may touch dangerous voltage points or create a short circuit. Never spill liquid of any kind on the product.
12. To reduce the risk of electric shock, do not disassemble this product, but take it to an authorized service facility. Opening or removing parts of the telephone base or handset other than specified access doors may expose you to dangerous voltages or other risks. Incorrect

reassembling can cause electric shock when the product is subsequently used.

13. Do not overload wall outlets and extension cords.
14. Unplug this product from the wall outlet and refer servicing to an authorized service facility under the following conditions:
  - When the power supply cord or plug is damaged or frayed.
  - If liquid has been spilled onto the product.
  - If the product has been exposed to rain or water.
  - If the product does not operate normally by following the operating instructions. Adjust only those controls that are covered by the operation instructions. Improper adjustment of other controls may result in damage and often requires extensive work by an authorized technician to restore the product to normal operation.
  - If the product has been dropped and the telephone base and/or handset has been damaged.
  - If the product exhibits a distinct change in performance.
15. Avoid using a telephone (other than cordless) during an electrical storm. There is a remote risk of electric shock from lightning.
16. Do not use the telephone to report a gas leak in the vicinity of the leak. Under certain circumstances, a spark may be created when the adapter is plugged into the power outlet, or when the handset is replaced in its cradle. This is a common event associated with the closing of any electrical circuit. The user should not plug the phone into a power outlet, and should not put a charged handset into the cradle, if the phone is located in an environment containing concentrations of flammable or flame-supporting gases, unless there is adequate ventilation. A spark in such an environment could create a fire or explosion. Such environments might include: medical use of oxygen without adequate ventilation; industrial gases (cleaning solvents; gasoline vapors; etc.); a leak of natural gas; etc.
17. Only put the handset of your telephone next to your ear when it is in normal talk mode.
18. The power adapter is intended to be correctly oriented in a vertical or floor mount position. The prongs are not designed to hold the plug in place if it is plugged into a ceiling, under-the-table or cabinet outlet.

19. For pluggable equipment, the socket outlet shall be installed near the equipment and shall be easily accessible.
20.   **CAUTION:** Use only the batteries indicated in this manual. There may be a risk of explosion if a wrong type of battery is used for the handset. Use only the supplied rechargeable batteries or replacement batteries (BT162342/ BT262342) for the handset. Do not dispose of batteries in a fire. They may explode.
- Do not use the battery in following conditions:
    - » High or low extreme temperature during use, storage or transportation.
    - » Replacement of a battery with an incorrect type that can defeat a safeguard.
    - » Disposal of a battery into fire or a hot oven, or mechanically crushing or cutting of a battery, that can result in an explosion.
    - » Leaving a battery in an extremely high temperature surrounding environment that can result in an explosion or the leakage of flammable liquid or gas.
    - » A battery subjected to extremely low air pressure that can result in an explosion or the leakage of flammable liquid or gas.
21. Use only the adapter included with this product. Incorrect adapter polarity or voltage can seriously damage the product.

## SAVE THESE INSTRUCTIONS

### Battery

- **CAUTION:** Use Only Supplied Battery. To order a replacement, visit our website at [www.vtechphones.com](http://www.vtechphones.com) or call 1 (800) 595-9511. In Canada, go to [phones.vtechcanada.com](http://phones.vtechcanada.com) or call 1 (800) 267-7377.
- Do not dispose of the battery in a fire. Check with local waste management codes for special disposal instructions.
- Do not open or mutilate the battery. Released electrolyte is corrosive and may cause burns or injury to the eyes or skin. The electrolyte may be toxic if swallowed.
- Exercise care in handling batteries in order not to create a short circuit with conductive materials.
- Charge the battery provided with this product only in accordance with the instructions and limitations specified in this manual.

### Precautions for users of implanted cardiac pacemakers

Cardiac pacemakers (applies only to digital cordless telephones):

Wireless Technology Research, LLC (WTR), an independent research entity, led a multidisciplinary evaluation of the interference between portable wireless telephones and implanted cardiac pacemakers. Supported by the U.S. Food and Drug Administration, WTR recommends to physicians that:

#### Pacemaker patients

- Should keep wireless telephones at least six inches from the pacemaker.
  - Should NOT place wireless telephones directly over the pacemaker, such as in a breast pocket, when it is turned ON.
  - Should use the wireless telephone at the ear opposite the pacemaker.
- WTR's evaluation did not identify any risk to bystanders with pacemakers from other persons using wireless telephones.

#### About cordless telephones

- **Privacy:** The same features that make a cordless telephone convenient create some limitations. Telephone calls are transmitted between the telephone base and the cordless handset by radio waves, so there is a possibility that the cordless telephone conversations could be intercepted by radio receiving equipment within range of the cordless handset. For this reason, you should not think of cordless telephone conversations as being as private as those on corded telephones.
- **Electrical power:** The telephone base of this cordless telephone must be connected to a working electrical outlet. The electrical outlet should not be controlled by a wall switch. Calls cannot be made from the cordless handset if the telephone base is unplugged, switched off or if the electrical power is interrupted.
- **Potential TV interference:** Some cordless telephones operate at frequencies that may cause interference to televisions and VCRs. To minimize or prevent such interference, do not place the telephone base of the cordless telephone near or on top of a TV or VCR. If interference is experienced, moving the cordless telephone farther away from the TV or VCR often reduces or eliminates the interference.

- **Rechargeable batteries:** Exercise care in handling batteries in order not to create a short circuit with conducting material such as rings, bracelets and keys. The battery or conductor may overheat and cause harm. Observe proper polarity between the battery and the battery charger.
- **Nickel-metal hydride rechargeable batteries:** Dispose of these batteries in a safe manner. Do not burn or puncture the battery. Like other batteries of this type, if burned or punctured, they could release caustic material which could cause injury.

### ECO mode

This power conserving technology reduces power consumption for optimal battery performance. The ECO mode activities automatically whenever the handset is synchronized with the telephone base.

## For C-UL compliance only

### Mesures de sécurité importantes

Afin de réduire les risques d'incendie, de blessures corporelles ou d'électrocution, suivez toujours ces mesures préventives de base lorsque vous utilisez votre téléphone :

1. Lisez et comprenez bien toutes les instructions.
2. Observez toutes les instructions et mises en garde inscrites sur l'appareil.
3. Débranchez ce téléphone de la prise murale avant de le nettoyer. N'utilisez pas de nettoyeurs liquides ni en aérosol. N'utilisez qu'un chiffon doux et légèrement humecté.
4. **ATTENTION:** Ne pas installer le socle téléphonique à une hauteur supérieure à 2 mètres.
5. N'utilisez pas ce produit près de l'eau, tel que près d'un bain, d'un lavabo, d'un évier de cuisine, d'un bac de lavage ou d'une piscine, ou dans un sous-sol humide ou sous la douche.
6. Ne déposez pas ce téléphone sur un chariot, support ou table chancelants. L'appareil pourrait tomber et être sérieusement endommagé.
7. Évitez d'installer le système téléphonique dans les endroits soumis à une température extrême, à la lumière directe du soleil ou à proximité immédiate d'autres appareils électriques ou électroniques. Protégez votre téléphone contre les sources d'humidité, la poussière, les vapeurs et les liquides corrosifs.
8. Le boîtier de l'appareil est doté de fentes et

d'ouvertures d'aération situées à l'arrière ou en dessous. Afin d'empêcher la surchauffe, ces ouvertures ne doivent pas être obstruées en plaçant l'appareil sur un lit, divan, tapis ou autre surface similaires. Ne placez pas cet appareil proximité d'un élément de chauffage ni d'une plinthe électrique. De plus, ne l'installez pas dans une unité murale ou un cabinet fermé qui ne possède pas d'aération adéquate.

9. Ne faites fonctionner cet appareil qu'avec le type d'alimentation indiqué sur les étiquettes de l'appareil. Si vous ne connaissez pas le voltage de votre maison, consultez votre marchand ou votre fournisseur d'électricité.
10. Ne déposez rien sur le cordon d'alimentation. Installez cet appareil dans un endroit sécuritaire, là où personne ne pourra trébucher sur la ligne d'alimentation ni le cordon téléphonique modulaire.
11. N'insérez jamais d'objets à travers les fentes et ouvertures de cet appareil, car ils pourraient toucher à des points de tension dangereux ou court-circuiter des pièces, ce qui constituerait un risque d'incendie ou d'électrocution. N'échappez pas de liquides dans l'appareil.
12. Afin de réduire les risques d'électrocution, ne démontez pas l'appareil, mais apportez-le plutôt à un centre de service qualifié s'il doit être réparé. En enlevant le couvercle, vous vous exposez à des tensions dangereuses ou autres dangers similaires. Un remontage inadéquat peut être à l'origine d'une électrocution lors d'une utilisation ultérieure de l'appareil. Débranchez l'appareil avant de procéder au nettoyage. Utilisez un chiffon humide et doux.
13. Ne surchargez pas les prises de courant et les rallonges.
14. Débranchez cet appareil de la prise de courant et communiquez avec le département de service à la clientèle de VTech dans les cas suivants:
  - Lorsque le cordon d'alimentation est endommagé ou écorché.
  - Si du liquide a été échappé dans l'appareil.
  - Si l'appareil a été exposé une source d'humidité telle que la pluie ou l'eau.
  - Si le produit ne fonctionne pas normalement en respectant les instructions de fonctionnement. Réglez uniquement les commandes indiquées dans les instructions de fonctionnement. Les réglages incorrects des autres commandes pourraient provoquer

un dommage qui pourrait exiger un travail exhaustif de la part d'un technicien autorisé afin de rétablir le fonctionnement normal de l'appareil.

- Si le produit a été échappé et que le socle et/ou le combiné a été endommagé.
- Si le produit affiche une nette diminution de sa performance.

15. Évitez d'utiliser un téléphone (autre qu'un sans fil) pendant un orage. Les éclairs peuvent être à l'origine d'une électrocution.

16. N'utilisez pas le téléphone pour rapporter une fuite de gaz à proximité de la fuite. En certaines circonstances, une flammèche pourrait être provoquée lorsque l'adaptateur est branché à une prise de courant, ou lorsque le combiné est déposé sur le socle. Ceci est un événement commun associé à la fermeture d'un circuit électrique. L'utilisateur ne devrait pas brancher le téléphone à une prise de courant, et ne devrait pas déposer le combiné chargé sur le socle, si le téléphone se trouve à proximité d'un endroit comportant des concentrations de gaz inflammables, moins que la ventilation soit adéquate. Une flammèche dans un tel endroit pourrait provoquer un incendie ou une explosion. De tels environnements peuvent comprendre: des endroits où l'on utilise de l'oxygène médical sans ventilation adéquate; des gaz industriels (dissolvants de nettoyage, des vapeurs d'essence, etc.); une fuite de gaz naturel, etc.

17. Ne placez que le combiné de votre téléphone près de votre oreille lorsqu'en mode de conversation.

18. Ces adaptateurs ont été conçus pour être orientés en position verticale ou montés au sol. Les broches ne sont pas conçues pour maintenir l'adaptateur en place si celui-ci est branché dans une prise au plafond ou sous une table/ armoire.

19. Pour le MATERIEL RACCORDE PAR PRISE DE COURANT, le socle de prise de courant doit être installé à proximité du matériel et doit être aisément accessible.



**MISE EN GARDE:** Il peut y avoir un risque d'explosion si vous utilisez le mauvais type de piles pour le téléphone. N'utilisez que les piles rechargeable inclus ou les piles de rechange (BT162342/BT262342). N'incinerez pas les piles. Celles-ci risqueraient d'exploser.

- Évitez d'utiliser la batterie dans les conditions suivantes:

- » des températures extrêmes faibles ou élevées auxquelles une batterie peut être soumise pendant l'utilisation, le stockage ou le transport;
- » Remplacement d'une batterie par un type incorrect pouvant supprimer une protection;
- » mise au rebut d'une batterie dans un feu ou dans un four chaud, ou écrasement mécanique ou coupure d'une batterie, susceptible de provoquer une explosion;
- » maintien d'une batterie dans un environnement à très haute température pouvant provoquer une explosion ou la fuite de liquide ou de gaz inflammables;
- » batterie soumise à une pression de l'air extrêmement faible pouvant provoquer une explosion ou la fuite de liquide ou de gaz inflammables.

21. N'utilisez que les adaptateurs inclus avec ce produit. L'utilisation d'un adaptateur dont la polarité ou la tension serait inadéquate risque d'endommager sérieusement le produit et mettre votre sécurité en péril.

## CONSERVEZ CES INSTRUCTIONS

### Pile

- N'utilisez que la pile incluse ou l'équivalent. Pour commander une pile de recharge, visitez notre site Web au [www.vtechphones.com](http://www.vtechphones.com) ou composez le 800-595-9511. Au Canada, visitez le [phones.vtechcanada.com](http://phones.vtechcanada.com) ou composez le 800-267-7377.
- Ne jetez pas la pile au feu. Vérifiez les instructions spécifiques de mise aux rebus auprès des autorités locales.
- N'ouvrez pas et ne mutilez pas la pile. L'électrolyte qui s'en échapperait est corrosif et pourrait causer des brûlures ou des blessures aux yeux ou à la peau. L'électrolyte est toxique si avalé.
- Soyez prudents lorsque vous manipulez les piles afin d'éviter les courts-circuits provoqués par des matériaux conducteurs.
- Rechargez la pile incluse avec cet appareil, selon les instructions et limites spécifiées dans ce guide d'utilisation.

## Stimulateurs cardiaques implantés dans l'organisme

Les simulateurs cardiaques (s'applique uniquement aux téléphones numériques sans fil):

L'organisme 'Wireless Technology Research, LLC (WTR)', une firme de recherche indépendante, a mené une évaluation pluridisciplinaire des interférences entre les téléphones sans fil portatifs et les stimulateurs cardiaques implantés dans l'organisme. Appuyée par l'Administration des aliments et drogues (FDA) des États-Unis, la firme WTR recommande aux médecins:

### Avis aux détenteurs de stimulateurs cardiaques

- Ils doivent tenir le téléphone sans fil à une distance d'au moins six pouces du stimulateur cardiaque.
- Ils ne doivent PAS placer le téléphone sans fil directement sur le stimulateur cardiaque, tel que dans une poche de chemise, lorsque celui-ci est en marche.
- Ils doivent utiliser le téléphone sans fil en l'appuyant sur l'oreille qui se trouve dans la direction opposée au stimulateur cardiaque.

L'étude effectuée par l'organisme WRS n'a pas identifié de risque pour les détenteurs de simulateurs cardiaques causés par les gens qui utilisent un téléphone sans fil à proximité de ceux-ci.

### À propos des téléphones sans fil

- Alimentation électrique: Les mêmes caractéristiques qui constituent des avantages pour les téléphones sans fil affichent également des restrictions. Les appels téléphoniques sont transmis entre le combiné sans fil et le socle par le biais d'ondes radio ; il y a donc la possibilité que vos conversations téléphoniques sans fil soient interceptées par des équipements de réception radio se trouvant dans la portée du combiné sans fil. Pour cette raison, vous ne devez pas percevoir les communications téléphoniques sans fil comme étant aussi confidentielles.
- Alimentation électrique: Le socle de ce téléphone sans fil doit être branché à une prise électrique fonctionnelle. La prise électrique ne doit pas être contrôlée par un interrupteur mural. Les appels ne pourront pas être effectués du combiné sans fil si le socle est débranché ou mis hors tension ou si le courant est coupé.

- Possibilité d'interférences aux téléviseurs: Certains téléphones sans fil fonctionnent sur des fréquences pouvant causer des interférences aux téléviseurs et aux magnétoscopes. Pour réduire ou prévenir de telles interférences, ne placez pas le socle du téléphone sans fil près ou sur un téléviseur ou magnétoscope. S'il y a présence de parasites, il est conseillé d'éloigner le téléphone sans fil du téléviseur ou du magnétoscope afin de réduire possiblement les interférences.
- Piles rechargeables: Manipulez les piles avec soin afin de ne pas les court-circuiter avec des bagues, bracelets ou clés. Les piles ou le conducteur peut surchauffer et causer des blessures. Respectez la polarité adéquate entre la pile et le chargeur.
- Les bloc-piles rechargeables à l'hydrure métallique de nickel: Jetez ces blocs-piles de manière écologique et sécuritaire. Ne les incinerez pas et ne les percez pas. Tel que les autres piles de ce type, elles pourraient dégager une matière toxique qui peut causer des blessures corporelles si elles sont brûlées ou percées.

### The RBRC seal

The RBRC seal on the nickel-metal hydride battery indicates that VTech Communications, Inc. is voluntarily participating in an industry program to collect and recycle these batteries at the end of their useful lives, when taken out of service within the United States and Canada.

The program provides a convenient alternative to placing used nickel-metal hydride batteries into the trash or municipal waste, which may be illegal in your area.

VTech's participation makes it easy for you to drop off the spent battery at local retailers participating in the program or at authorized VTech product service centers. Please call

**1 (800) 8 BATTERY®** for information on Ni-MH battery recycling and disposal bans/restrictions in your area. VTech's involvement in this program is part of its commitment to protecting our environment and conserving natural resources.

**The RBRC seal and 1 (800) 8 BATTERY® are registered trademarks of Call2recycle, Inc.**



## FCC, ACTA and IC regulations FCC Part 15

This equipment has been tested and found to comply with the requirements for a Class B digital device under Part 15 of the Federal Communications Commission (FCC) rules. These requirements are intended to provide reasonable protection against harmful interference in a residential installation. This equipment generates, uses and can radiate radio frequency energy and, if not installed and used in accordance with the instructions, may cause harmful interference to radio communications. However, there is no guarantee that interference will not occur in a particular installation. If this equipment does cause harmful interference to radio or television reception, which can be determined by turning the equipment off and on, the user is encouraged to try to correct the interference by one or more of the following measures:

- Reorient or relocate the receiving antenna.
- Increase the separation between the equipment and receiver.
- Connect the equipment into an outlet on a circuit different from that to which the receiver is connected.
- Consult the dealer or an experienced radio/TV technician for help.

Changes or modifications to this equipment not expressly approved by the party responsible for compliance could void the user's authority to operate the equipment.

This device complies with Part 15 of the FCC rules. Operation is subject to the following two conditions: (1) this device may not cause harmful interference, and (2) this device must accept any interference received, including interference that may cause undesired operation. Privacy of communications may not be ensured when using this telephone.

To ensure safety of users, the FCC/ISED has established criteria for the amount of radio frequency energy that can be safely absorbed by a user or bystander according to the intended usage of the product. This product has been tested and found to comply with the FCC/ISED criteria. The handset may be safely held against the ear of the user. The telephone base shall be installed and used such that parts of the user's body other than the hands are maintained at a distance of approximately 20 cm (8 inches) or more.

This Class B digital apparatus complies with Canadian requirement:  
CAN ICES-3 (B)/NMB-3(B).

## FCC Part 68 and ACTA

This equipment complies with Part 68 of the FCC rules and with technical requirements adopted by the Administrative Council for Terminal Attachments (ACTA). The label on the back or bottom of this equipment contains, among other things, a product identifier in the format US:AAAEQ##TXXXX. This identifier must be provided to your telephone service provider upon request.

The plug and jack used to connect this equipment to premises wiring and the telephone network must comply with applicable Part 68 rules and technical requirements adopted by ACTA. A compliant telephone cord and modular plug is provided with this product. It is designed to be connected to a compatible modular jack that is also compliant. An RJ11 jack should normally be used for connecting to a single line and an RJ14 jack for two lines. See the installation instructions in the user's manual.

The Ringer Equivalence Number (REN) is used to determine how many devices you may connect to your telephone line and still have them ring when you are called. The REN for this product is encoded as the 6th and 7th characters following the US: in the product identifier (e.g., if ## is 03, the REN is 0.3). In most, but not all areas, the sum of all RENs should be five (5.0) or less. For more information, please contact your telephone service provider.

This equipment may not be used with Party Lines. If you have specially wired alarm dialing equipment connected to your telephone line, ensure the connection of this equipment does not disable your alarm equipment. If you have questions about what will disable alarm equipment, consult your telephone service provider or a qualified installer.

If this equipment is malfunctioning, it must be unplugged from the modular jack until the problem has been corrected. Replacement to this telephone equipment can only be made by the manufacturer or its authorized agents. For replacement procedures, follow the instructions outlined under the "Limited warranty".

If this equipment is causing harm to the telephone network, the telephone service provider may temporarily discontinue your telephone service. The telephone service provider is required to notify you before interrupting service. If advance notice is not

practical, you will be notified as soon as possible. You will be given the opportunity to correct the problem and the telephone service provider is required to inform you of your right to file a complaint with the FCC. Your telephone service provider may make changes in its facilities, equipment, operation, or procedures that could affect the proper functioning of this product. The telephone service provider is required to notify you if such changes are planned.

If this product is equipped with a corded or cordless handset, it is hearing aid compatible.

If this product has memory dialing locations, you may choose to store emergency telephone numbers (e.g., police, fire, medical) in these locations. If you do store or test emergency numbers, please:

Remain on the line and briefly explain the reason for the call before hanging up.

Perform such activities in off-peak hours, such as early morning or late evening.

## Industry Canada

This device contains licence-exempt transmitter(s)/receiver(s) that comply with Innovation, Science and Economic Development Canada's licence-exempt RSS(s).

Operation is subject to the following two conditions: (1) this device may not cause interference, and (2) this device must accept any interference, including interference that may cause undesired operation.

Privacy of communications may not be ensured when using this telephone.

The term "IC:" before the certification/registration number only signifies that the Industry Canada technical specifications were met.



The Ringer Equivalence Number (REN) for this terminal equipment is 1.0. The REN is an indication of the maximum number of devices allowed to be connected to a telephone interface. The termination on an interface may consist of any combination of devices subject only to the requirement that the sum of the RENs of all the devices does not exceed five.

This product meets the applicable Innovation, Science and Economic Development Canada technical specifications.

## California Energy Commission battery charging testing instructions

This telephone is set up to comply with the energy-conserving standards right out of the box. These instructions are intended for California Energy Commission (CEC) compliance testing only. When the CEC battery charging testing mode is activated, all telephone functions, except battery charging, will be disabled.

### To activate the CEC battery charging testing mode:

1. Unplug the telephone base power adapter from the power outlet. Make sure all handsets are plugged with charged batteries before proceeding.
2. While you press and hold  /**FIND HANDSET**, plug the telephone base power adapter back to the power outlet.
3. After about 10 seconds, when the **IN USE** light starts flashing and the telephone base shows **Registering...** and then **De-register?**, release  /**FIND HANDSET** and immediately press it again within two seconds.

When the phone successfully enters the CEC battery charging testing mode, all handsets display **To register HS...** and **...see manual** alternately.

When the phone fails to enter this mode, repeat steps 1 to 3 above.

### To deactivate the CEC battery charging testing mode:

1. Unplug the telephone base power adapter from the power outlet, then plug it back in. Then the telephone base is powered up as normal.
2. Press and hold  /**FIND HANDSET** on the telephone base for about four seconds until the **IN USE** light turns on and the handset shows **Registering...**
3. Press **QUIET #** on the handset. The handset shows **Registered** and you hear a beep when the registration process completes. This process takes about 60 seconds.



<b>Configure   Settings</b>	<b>56</b>	<b>General product care</b>	<b>65</b>
<b>Answering system settings</b>	<b>56</b>	Taking care of your telephone	65
Set your built-in answering system	56	Avoid rough treatment	65
Set answering system through voice guide	56	Avoid water	65
Set remote access code	57	Electrical storms	65
Turn on or off the message alert tone	57	Cleaning your telephone	65
<b>Area code settings</b>	<b>58</b>	<b>Technical specifications</b>	<b>66</b>
Set home area code	58	DECT 6.0 digital technology	67
<b>Dial modes</b>	<b>59</b>	Telephone operating range	67
Temporary tone dialing	59	Redefining long range coverage and clarity	67
Set dial mode	59	Simulated full-duplex handset and base speakerphones	67
<b>Ringer</b>	<b>59</b>	<b>Frequently asked questions</b>	<b>68</b>
Set ringer tone	59		
Set ringer volume	60		
<b>Set date and time</b>	<b>60</b>		
<b>Set languages</b>	<b>61</b>		
Set LCD language	61		
Set voice language	61		
<b>Sound settings</b>	<b>62</b>		
Set number of rings	62		
Set QUIET mode	62		
Set listening volume	63		
Set key tone	63		
<b>Voicemail settings</b>	<b>64</b>		
Set speed dial voicemail number	64		
<b>Add and register handset</b>	<b>64</b>		

# Install | Set up

## What's in the box

Your telephone package contains the following items. Save your sales receipt and original packaging in case it is necessary to ship your telephone for warranty service.

You can add new handsets (**VS208-0**) to your telephone system. All accessories are sold separately. Your telephone base supports a maximum of five devices.

### NOTE

- To purchase replacement batteries or power adapters, visit our website at [www.vtechphones.com](http://www.vtechphones.com) or call 1 (800) 595-9511. In Canada, go to [phones.vtechcanada.com](http://phones.vtechcanada.com) or dial 1 (800) 267-7377.



- 1 set for VG208
- 2 sets for VG208-2

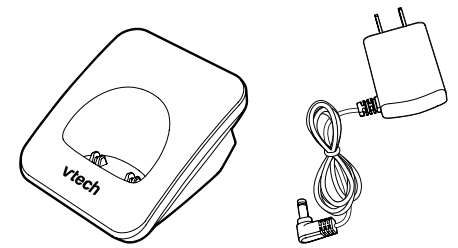

- 2 sets for VG208-2

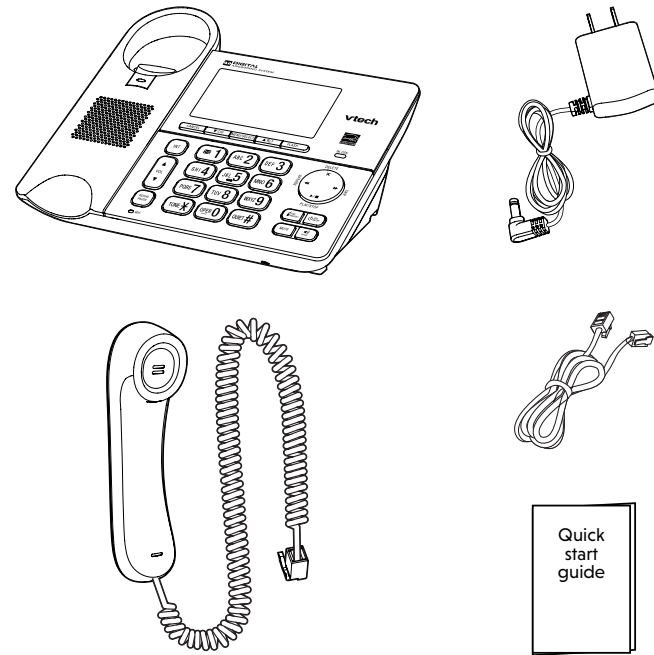

# Connect the telephone base    Connect the charger

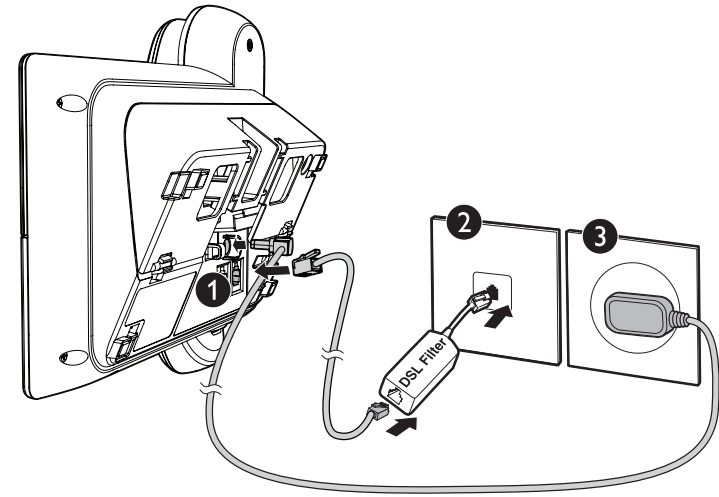

### TIPS

- If you want to mount the base, make sure telephone line pass through the mounting bracket before connecting to the DSL filter.
- If you subscribe to digital subscriber line (DSL) high-speed Internet service through your telephone line, make sure you connect a DSL filter (not included) to the telephone wall jack.

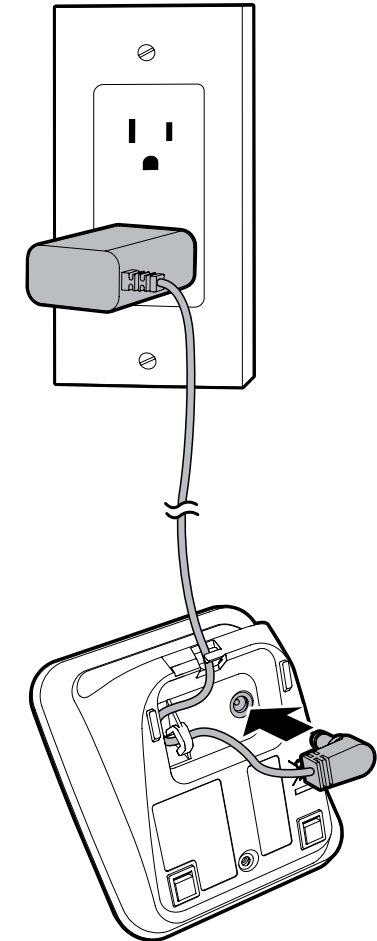



## Install the battery

1. Plug the battery connector securely into the socket inside the handset battery compartment.
  - Make sure the battery label **THIS SIDE UP** is facing up, as indicated.

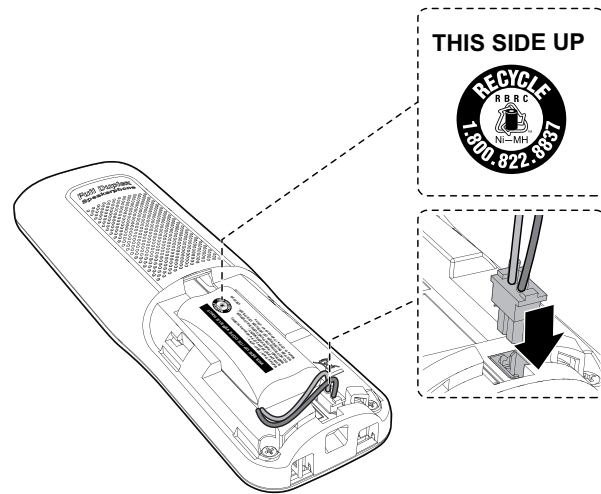

2. Align the cover flat against the battery compartment, then slide it upwards until it clicks into place.

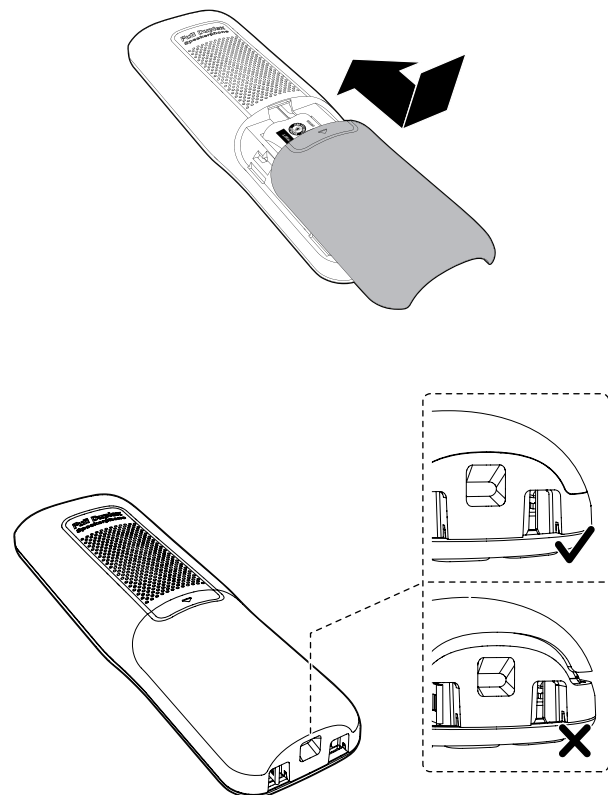

## Charge the battery

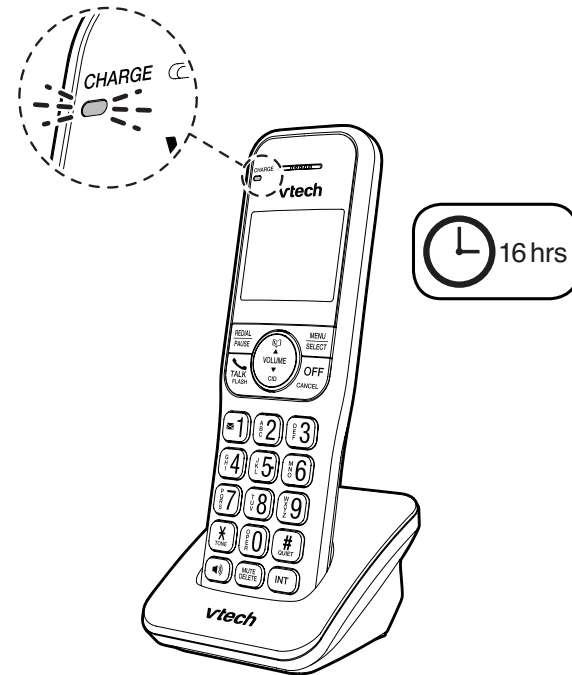

The following table summarizes the battery indicators and actions to take.

Battery indicators	Battery status	Action
<ul style="list-style-type: none"> <li>• The screen is blank, or shows <b>Put in charger</b> and  flashes.</li> </ul>	<ul style="list-style-type: none"> <li>• The battery has no charge or very little charge. The handset cannot be used.</li> </ul>	<ul style="list-style-type: none"> <li>• Charge without interruption (at least 30 minutes).</li> </ul>
<ul style="list-style-type: none"> <li>• The screen shows <b>Low battery</b> and  flashes.</li> </ul>	<ul style="list-style-type: none"> <li>• The battery has enough charge to be used for a short time.</li> </ul>	<ul style="list-style-type: none"> <li>• Charge without interruption (at least 30 minutes).</li> </ul>
<ul style="list-style-type: none"> <li>• The screen shows <b>HANDSET X.</b></li> </ul>	<ul style="list-style-type: none"> <li>• The battery is charged.</li> </ul>	<ul style="list-style-type: none"> <li>• To keep the battery charged, place it in the handset charger when not in use.</li> </ul>

When it is fully charged, you can expect the following performance:

<b>Operation</b>	• Operating time *
<b>Talk time (cordless handset)</b>	• 7 hours
<b>Standby</b>	• 5 days

\* Operating times vary depending on your actual use and the age of the battery.

### Check the battery level

After you have installed the battery, check the battery level on the handset screen.

- If the screen is blank, or flashes, then the battery needs to be charged. Go to **Charge the battery** section before you do any setting or operation.
- If the battery icon is , , or , then go to **Set the date and time** and **Set the answering system through voice guide** section.

## Check for dial tone

Lift the corded handset, or press **TALK/FLASH** on the cordless handset. If you hear a dial tone, the installation is successful.

### If you do not hear a dial tone

- Make sure the installation procedures are properly done.
- The handset may take a second or two to find the telephone base and produce a dial tone. This is normal. Wait an extra second before dialing.
- If the previous suggestions do not work, disconnect the telephone line cord from your telephone and connect the telephone line cord to another telephone.
- If there is no dial tone on that other telephone either, your telephone line cord may be defective. Install a new telephone line cord.
- If changing the telephone line cord does not help, the wall jack (or the wiring to this wall jack) may be defective. Try using a different wall jack in your home to connect your **VG208/VG208-2** telephone, or contact your telephone service provider (charges may apply).

## Before use

### Set date and time (before use)

After you install your telephone or power returns following a power outage and battery depletion, the handset and telephone base will prompt you to set the date and time, and to configure the answering system through voice guide.

#### NOTE

- Make sure you set the date and time including the year correctly; otherwise the answering system does not announce the correct day of the week for your recorded messages time stamp.

1. Use the dialing keys (**0-9**) to enter the month (**MM**), date (**DD**) and year (**YY**). Then, press **MENU/SELECT**.
2. Use the dialing keys (**0-9**) to enter the hour (**HH**) and minute (**MM**). Then press **▼ CID** or **▲**  to choose **AM** or **PM**.
3. Press **MENU/SELECT** to save.

After setting the date and time, the handset will prompt if you want to set **Answering system (before use)**.

#### TIP

- To skip setting the date and time, press **OFF/CANCEL** on the handset or **CANCEL** on the telephone base.



### Set up through voice guide - Answering system (before use)

After the date and time setting is done or skipped, the handset and the telephone base will then prompt if you want to set up the answering system.

This feature assists you to do the basic setup of the answering system. You can follow the voice guide to record your own announcement, set the number of rings and the message alert tone.

1. Press **MENU/SELECT** to start the answering system setup via voice guide. You hear the voice prompt "*Hello! This voice guide will assist you with the basic setup of your answering system.*"
  - To skip the set up, press **CANCEL**.
2. Setup your answering system by inputting the designated numbers as instructed in the voice guide.

### Alternate way to set up

1. Press **MENU/SELECT** on the telephone in idle mode.
2. Press **▼ CID** or **▲**  to scroll to **Answering sys**, and then press **MENU/SELECT**.
3. Press **▼ CID** or **▲**  to scroll to **Voice guide**, then press **MENU/SELECT**. You hear the voice prompt "*Hello! This voice guide will assist you with the basic setup of your answering system.*"
4. Set up your answering system by inputting designated numbers as instructed in the voice guide.

#### NOTE

- You can press **CANCEL** to quit the voice guide at any time.

## Install

### Mount the telephone base

Your telephone base is ready for tabletop use. If you want to mount your telephone on a wall, use the provided wall-mount bracket to attach to a standard dual-stud telephone wall-mounting plate. If you do not have this wall-mounting plate, you can purchase one from many hardware or consumer electronics retailers. You may need a professional to install the wall-mounting plate.

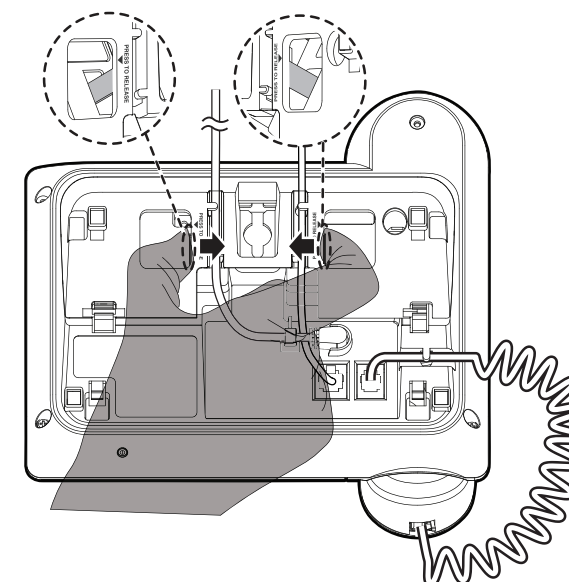
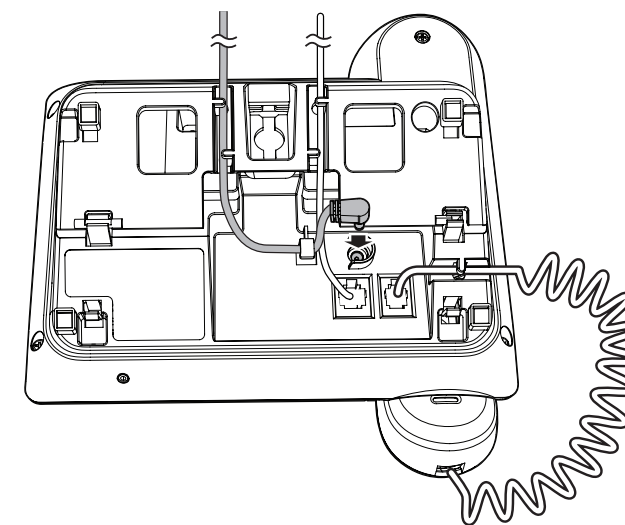

## Overview

### Telephone base

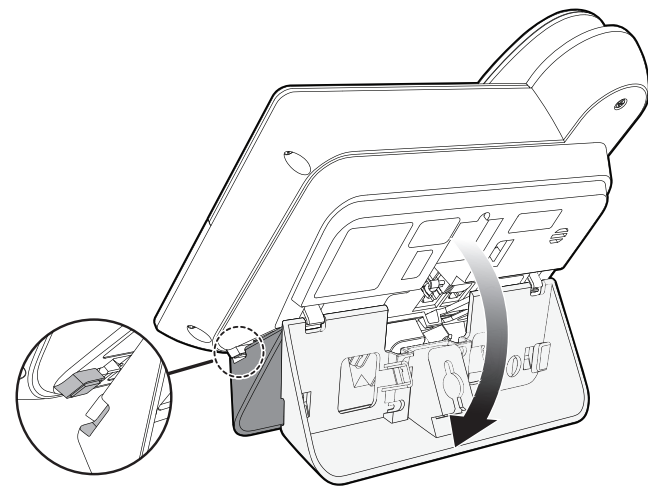

3.

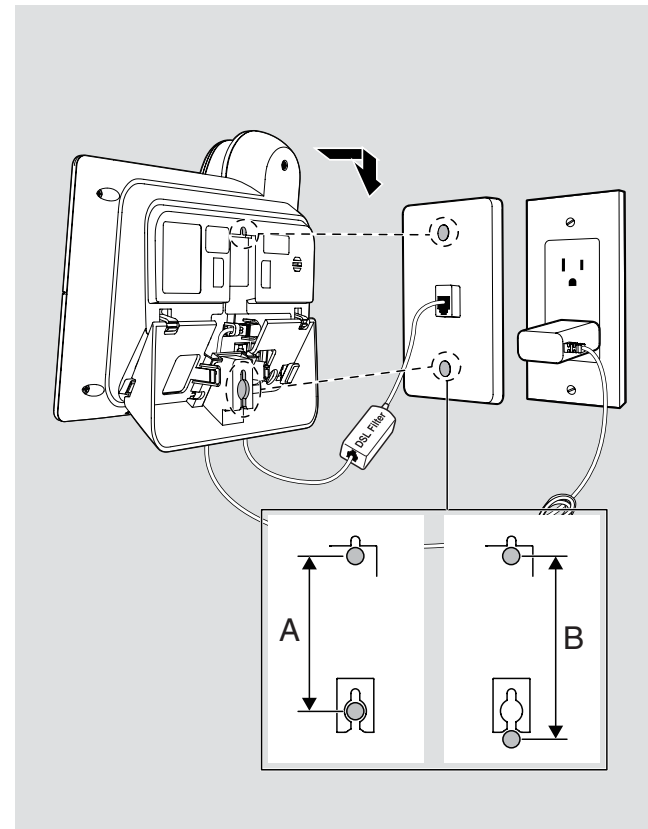
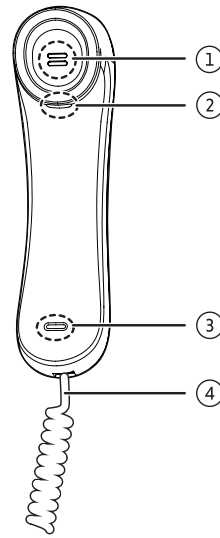

4.



1	Handset earpiece	
2	Switch hook	
3	Microphone	
4	Coiled handset cord	
5	LCD display	
6	<b>CANCEL</b>	<ul style="list-style-type: none"> <li>• During a call, press to hang up.</li> <li>• While in a menu, press to cancel an operation, back up to the previous menu, or exit the menu display; or <b>press and hold</b> this button to exit to idle mode.</li> <li>• When the telephone is ringing, press to mute the ringer temporarily.</li> <li>• <b>Press and hold</b> while the telephone is not in use to erase the missed call indicator.</li> </ul>

6	<b>▼CID</b>	<ul style="list-style-type: none"> <li>• Press to review the caller ID log when the telephone is not in use.</li> <li>• Press to scroll down while in a menu.</li> <li>• While entering names or numbers, press to move the cursor to the left.</li> </ul>
	<b>MENU/SELECT</b>	<ul style="list-style-type: none"> <li>• Press to display the menu.</li> <li>• Once in the menu, press to select an item or save an entry or setting.</li> </ul>
	<b>▲</b>	<ul style="list-style-type: none"> <li>• Press to show phonebook entries when the telephone is not in use.</li> <li>• Press to scroll up while in a menu.</li> <li>• While entering names or numbers, press to move the cursor to the right.</li> </ul>
7	<b>FLASH</b>	<ul style="list-style-type: none"> <li>• Answer an incoming call when you receive a call waiting alert.</li> </ul>
	<b>IN USE light</b>	<ul style="list-style-type: none"> <li>• On when the telephone is in use, or when the answering system is answering a call.</li> <li>• On when a handset is being registered.</li> <li>• Flashes when there is an incoming call.</li> <li>• Flashes when handsets are being deregistered.</li> <li>• Flashes when another telephone on the same line is in use.</li> </ul>



8		<ul style="list-style-type: none"> <li>• <b>X/DELETE</b> <ul style="list-style-type: none"> <li>• Press to delete the message or announcement currently playing.</li> <li>• When the telephone is not in use, press twice to delete all previously reviewed messages.</li> <li>• While reviewing the redial list, phonebook or caller ID log, press to delete an individual entry.</li> <li>• While entering names or numbers, press to delete a character or digit.</li> </ul> </li> <li>• <b>◀/REPEAT</b> <ul style="list-style-type: none"> <li>• Press to repeat a message or press twice to play the previous message.</li> </ul> </li> <li>• <b>▶/SKIP</b> <ul style="list-style-type: none"> <li>• During message playback, press to skip to the next message.</li> </ul> </li> <li>• <b>▶/PLAY/STOP</b> <ul style="list-style-type: none"> <li>• Press to play messages.</li> <li>• Press to stop message playback.</li> <li>• Flashes when there are new messages or memos in the answering system.</li> </ul> </li> </ul>
		<ul style="list-style-type: none"> <li>• Press to page all handsets when the phone is not in use.</li> </ul>
9	/ <b>FIND HANDSET</b>	<ul style="list-style-type: none"> <li>• Press to page all handsets when the phone is not in use.</li> </ul>
10	<b>ANS ON/OFF</b>	<ul style="list-style-type: none"> <li>• Press to turn on the answering system and press again to turn off. The light is on when on the answering system is on.</li> </ul>
11	<b>SPEAKER</b>	<ul style="list-style-type: none"> <li>• Press to make or answer a call using the speakerphone.</li> </ul>

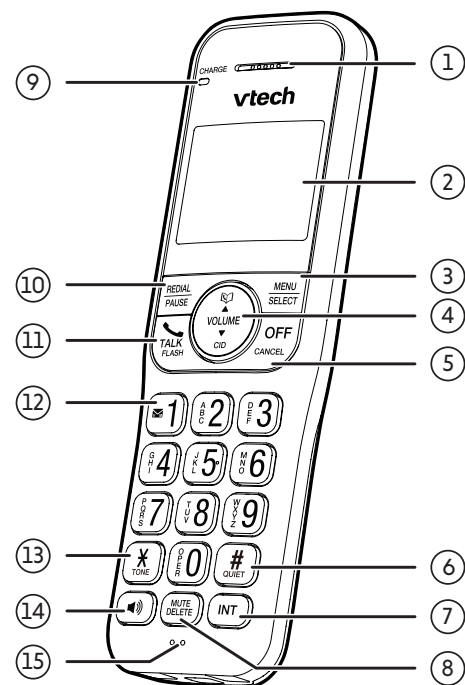

12	<b>MUTE</b>	<ul style="list-style-type: none"> <li>Mute the microphone during a call.</li> <li>Silence the ringer temporarily while the handset is ringing.</li> </ul>
13	<b>INT</b>	<ul style="list-style-type: none"> <li>Press to start an intercom conversation or transfer a call (for multi-handset models only).</li> </ul>
14	<b>▲ VOL ▼</b>	<ul style="list-style-type: none"> <li>Press to adjust the listening volume during a call.</li> <li>When the telephone is not in use, press to adjust the telephone base ringer volume.</li> </ul>
15	<b>REDIAL/ PAUSE</b>	<ul style="list-style-type: none"> <li>Press repeatedly to view the last 10 numbers dialed.</li> <li>While entering numbers, <u>press and hold</u> to insert a dialing pause.</li> </ul>
16	<b>Microphone</b>	
	 <b>1</b>	<ul style="list-style-type: none"> <li>While reviewing a caller ID log entry, press repeatedly to add or remove 1 in front of the telephone number before dialing or saving it in the phonebook.</li> <li><u>Press and hold</u> to set or dial your voicemail number.</li> </ul>
17	<b>QUIET #</b>	<ul style="list-style-type: none"> <li><u>Press and hold</u> to set and turn on the <b>QUIET</b> mode, or turn it off.</li> <li>When reviewing a caller ID log entry, press repeatedly to view other dialing options.</li> </ul>
	<b>OPER 0 _</b>	<ul style="list-style-type: none"> <li>Press to enter space during text editing.</li> </ul>
	<b>TONE ✕</b>	<ul style="list-style-type: none"> <li>Press to switch to tone dialing temporarily during a call if you have pulse service.</li> </ul>

## Handset



1	Handset earpiece
2	LCD display
3	<b>MENU/ SELECT</b> <ul style="list-style-type: none"> <li>Press to display the menu.</li> <li>Once in the menu, press to select an item or save an entry or setting.</li> </ul>

4		<ul style="list-style-type: none"> <li> <b>VOLUME</b> <ul style="list-style-type: none"> <li>Press to show phonebook entries when the telephone is not in use.</li> <li>Press to scroll up while in a menu.</li> <li>Press to increase the listening volume when on a call, or increase the message playback volume.</li> <li>While entering names or numbers, press to move the cursor to the right.</li> </ul> </li> <li><b>VOLUME ▼ / CID</b> <ul style="list-style-type: none"> <li>Press to review the caller ID log when the telephone is not in use.</li> <li>Press to scroll down while in a menu.</li> <li>Press to decrease the listening volume when on a call, or decrease the message playback volume.</li> <li>While entering names or numbers, press to move the cursor to the left.</li> </ul> </li> </ul>
5	<b>OFF/ CANCEL</b>	<ul style="list-style-type: none"> <li>During a call, press to hang up.</li> <li>While in a menu, press to cancel an operation, back up to the previous menu, or exit the menu display; or <u>press and hold</u> this button to exit to idle mode.</li> <li>When the handset is ringing, press to mute the ringer temporarily.</li> <li><u>Press and hold</u> while the handset is not in use to erase the missed call indicator.</li> </ul>

6	<b>QUIET #</b>	<ul style="list-style-type: none"> <li><u>Press and hold</u> to set and turn on the <b>QUIET</b> mode, or turn it off.</li> <li>When reviewing a caller ID log entry, press repeatedly to view other dialing options.</li> </ul>
7	<b>INT</b>	<ul style="list-style-type: none"> <li>Press to start an intercom conversation or transfer a call (for multi-handset models only).</li> </ul>
8	<b>MUTE/ DELETE</b>	<ul style="list-style-type: none"> <li>Mute the microphone during a call.</li> <li>Delete digits or characters while using the dialing keys.</li> <li>Silence the ringer temporarily while the handset is ringing.</li> </ul>
9	<b>CHARGE light</b>	<ul style="list-style-type: none"> <li>On when the handset is charging in the handset charger.</li> </ul>
10	<b>REDIAL/ PAUSE</b>	<ul style="list-style-type: none"> <li>Press repeatedly to view the last 10 numbers dialed.</li> <li>While entering numbers, <u>press and hold</u> to insert a dialing pause.</li> </ul>
11	 <b>TALK/ FLASH</b>	<ul style="list-style-type: none"> <li>Press to make or answer a home call.</li> <li>During a call, press to answer an incoming call when you receive a call waiting alert.</li> </ul>
12	 <b>1</b>	<ul style="list-style-type: none"> <li>While reviewing a caller ID log entry, press repeatedly to add or remove 1 in front of the telephone number before dialing or saving it in the phonebook.</li> <li><u>Press and hold</u> to set or dial your voicemail number.</li> </ul>
13	<b>TONE ✕</b>	<ul style="list-style-type: none"> <li>Press to switch to tone dialing temporarily during a call if you have pulse service.</li> </ul>



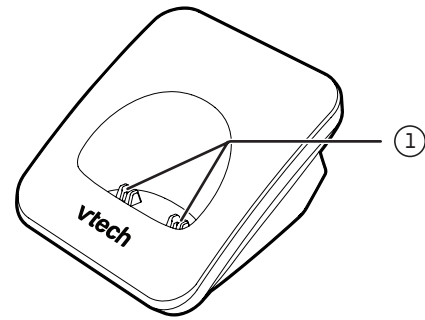



14		<ul style="list-style-type: none"> <li>Press to make or answer a call using the speakerphone.</li> <li>Press to turn on the handset speakerphone, press again to resume normal handset use.</li> </ul>
15	Microphone	

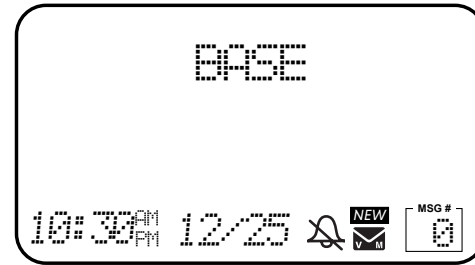
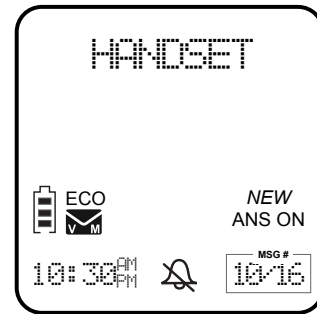

1 Charging pole

### Display



1		<ul style="list-style-type: none"> <li>The handset battery is low and needs charging.</li> </ul>
2		<ul style="list-style-type: none"> <li>The handset battery is charging.</li> </ul>
3		<ul style="list-style-type: none"> <li>The handset battery is fully charged.</li> </ul>
4		<ul style="list-style-type: none"> <li>Ringer is off.</li> </ul>
5		<ul style="list-style-type: none"> <li>New voicemail received from your telephone service provider.</li> </ul>
6	<i>NEW</i>	<ul style="list-style-type: none"> <li>There are new caller ID log entries.</li> </ul>
7	ANS ON	<ul style="list-style-type: none"> <li>Answering system is on.</li> </ul>
8		<ul style="list-style-type: none"> <li>Number of new/old messages recorded.</li> </ul>

9	ECO	<ul style="list-style-type: none"> <li>The ECO mode activates automatically to reduce power consumption when the handset is within range of the telephone base.</li> </ul>
---	-----	--

### Handset lights

1	CHARGE	<ul style="list-style-type: none"> <li>On when the handset is charging in the handset charger.</li> </ul>
2		<ul style="list-style-type: none"> <li>On when the speakerphone is in use.</li> </ul>



### Telephone base lights

1	IN USE	<ul style="list-style-type: none"> <li>On when the telephone line is in use.</li> <li>On when the answering system is answering a call.</li> <li>On when you are registering a handset.</li> <li>Flashes quickly when there is an incoming call.</li> <li>Flashes when another telephone sharing the same line is in use.</li> <li>Flashes when you are deregistering all handsets.</li> </ul>
2		<ul style="list-style-type: none"> <li>On when the answering system is turned on.</li> </ul>

### Operating range

This cordless telephone operates with the maximum power allowed by the Federal Communications Commission (FCC). Even so, this handset and telephone base can communicate over only a certain distance which can vary with the locations of the telephone base and handset, the weather, and the layout of your home or office.

When the handset is out of range, the handset displays **Out of range or no pwr at base**.

If there is a call while the handset is out of range, it may not ring, or if it does ring, the call may not connect well when you press  **TALK/FLASH**. Move closer to the telephone base, and then press  **TALK/FLASH** to answer the call. If the handset moves out of range during a telephone conversation, there may be interference. To improve reception, move closer to the telephone base.

# Operate

## Make, answer or end a call

### Make a call

#### Using a cordless handset



Press  TALK/FLASH or , on the handset, then enter the telephone number.

#### Using the telephone base

Lift the corded handset, or press /SPEAKER, then enter the telephone number.

### Predial a call

#### Using a cordless handset

Enter the telephone number, then press  TALK/FLASH or  to dial.

- When entering numbers, press **MUTE/DELETE** or **OFF/CANCEL** to make corrections.

#### Using the telephone base

Enter the telephone number, then lift the corded handset or press /SPEAKER to dial.

- When entering numbers, press **X/DELETE** to make corrections.

### Answer a call

#### Using a cordless handset

Press  TALK/FLASH or , or any dialing keys (**0-9** or **TONE X** or **QUIET#**).

#### Using the telephone base

Lift the corded handset, or press /SPEAKER or any dialing keys.

### End a call

#### Using a cordless handset

Press **OFF/CANCEL** or put the handset in the handset charger.

#### Using the telephone base

When you are using the corded handset, place it on the telephone base.

**-OR-**

When you are using the base speakerphone, press /SPEAKER.

### NOTES

- The screen displays **Unable to call** if the telephone line is in use.
- The screen shows the elapsed time as you talk (in hours, minutes and seconds).
- When entering numbers, press and hold **REDIAL/PAUSE** to insert a dialing pause (a **P** appears).

## View dialing options

Although the caller ID log entries may contain 10 digits (the area code plus the 7-digit number), in some areas, you may need to dial only the seven digits, or 1 plus the seven digits, or 1 plus the area code plus the seven digits. You can change the number of digits that you dial from the caller ID log or store to the phonebook.

While reviewing the caller ID log, press **#** (pound key) repeatedly to show different dialing options for local and long distance numbers before dialing or saving the telephone number in the phonebook.

Press **1** repeatedly if you need to add or remove **1** in front of the telephone number before dialing or saving it in the phonebook.

When the number shows the correct format for dialing:

Press  TALK/FLASH or  on the handset to call the number.

**-OR-**

If you are using the telephone base, lift the corded handset, or press /SPEAKER to call the number.

## Sound

### Use speakerphone

#### Handset speakerphone

During a call, press  to switch between the speakerphone and normal handset use.

To hand up, press **OFF/CANCEL** or return the handset to handset charger.

#### Telephone base speakerphone

During a call, press /SPEAKER to switch between the telephone base speakerphone and the corded handset.

### Volume control

#### To adjust the listening volume on a cordless handset

During a call, press **VOLUME▼** or **VOLUME▲** to adjust the listening volume.

#### To adjust the listening volume at the telephone base

During a call, press **▼VOL** or **VOL▲**.

### NOTES

- The handset and speakerphone volume settings are independent.
- When the volume reaches the minimum or maximum setting, you hear two beeps.

## Mute the microphone

Use the mute function to turn off the microphone. You can hear the caller, but the caller cannot hear you.

### To mute a call

While on a call, press **MUTE/DELETE** on the handset, or **MUTE** on the telephone base. The screen displays **Muted** until the mute function is turned off.

### To end mute a call

Press **MUTE/DELETE** on the handset or **MUTE** on the telephone base again and resume speaking. The screen briefly displays **Microphone on**. Mute is automatically cancelled when you end the call.

## Temporary ringer silencing

When the telephone is ringing, you can temporarily silence the ringer of the handset without disconnecting the call. The next call rings normally at the preset volume.

### To silence the handset ringer

Press **OFF/CANCEL** or **MUTE/DELETE** on the handset. The handset screen shows **Ringer muted** and .

### To silence the telephone base ringer

Press **MUTE** or **CANCEL** on the telephone base. The screen displays **Ringer muted** and .

## Join a call



### Join a call in progress

You can use the telephone base and a cordless handset, or two cordless handsets at a time on an outside call.

### To join a call with a cordless handset



- When a handset or the telephone base is already on a call, press **TALK/FLASH** or  on another handset to join the call.
- Press **OFF/CANCEL** or place the handset in the handset charger to exit the call. The call continues until both devices hang up.

### To join a call with the telephone base

- Lift the corded handset or press /**SPEAKER**.
- Place the corded handset back to the telephone base or press /**SPEAKER** to exit the call. The call continues until both devices hang up.

## Call waiting

If you subscribe to call waiting service from your telephone service provider, and someone calls while you are already on a call, you hear an alert tone.

1. Press  **TALK/FLASH** on the handset or **FLASH** on the telephone base to put your current call on hold and take the new call.
2. Press  **TALK/FLASH** on the handset or **FLASH** on the telephone base at any time to switch back and forth between calls.

If you also subscribe to caller ID service, it will let you see the name and telephone number of the caller during call waiting. It may be necessary to change your telephone service to use this feature. Contact your telephone service provider if:

- You have both caller ID and call waiting, but as separate service (you may need to combine these service);
- You have only caller ID service, or only call waiting service; or
- You do not subscribe to caller ID or call waiting services.

There are fees for caller ID services. In addition, services may not be available in all areas.

## Intercom

Use the intercom feature for conversations between the telephone base and a cordless handset, or two cordless handsets.

### NOTES

- Your telephone base supports up to five handsets. You can buy additional expansion handsets (**VG208-0**) for this telephone base.
- You can use four devices on two pairs of intercom calls. For example, when four handsets are used on two pairs of intercom calls, use the fifth handset for an outside call.

### Initiate an intercom call with a cordless handset

1. Press **INT** on your handset when not in use.
  - If you have only one handset, the telephone base displays **Calling base**. The telephone base rings and shows **HS 1 is calling**.
  - If you have two or more handsets, your handset shows **Intercom to:**. Press **7** for the telephone base or **1-5** for **HANDSET 1** to **HANDSET 5**. Your handset shows **Calling HS X** or **Calling base**. The destination handset rings and shows **HS X is calling**.

- To answer the intercom call, press **TALK/FLASH**, **INT** or any dialing key on the destination handset. Both handsets now display **Intercom**.

**-OR-**

To answer the intercom call at the telephone base, press **SPEAKER**, **INT**, any of the dialing keys, or lift the corded handset. Both devices now show **Intercom**.

- To end the intercom call on either handset, one party presses **OFF/CANCEL**, or places the handset back in the handset charger.

**-OR-**

To end the intercom call at the telephone base, press **INT** or **SPEAKER** when using the base speakerphone, or place the corded handset back to the telephone base.

#### NOTES

- To cancel the intercom call before it is answered, press **OFF/CANCEL** or **INT**.
- Press **OFF/CANCEL** or **MUTE/DELETE** on the cordless handset, or **CANCEL** or **MUTE** on the telephone base to temporarily silence the intercom ringer.
- If the destination handset does not answer the intercom call within 100 seconds, is accessing the answering system, on a call or out of range, the originating handset displays **Unable to call** and returns to idle mode.
- If there is an incoming call while the originating handset displays **Calling**

**HS X**, the intercom request will be stopped and the screen displays **Incoming call**.

- If the telephone base is on a call, or does not answer the intercom call within 100 seconds, your handset displays **Unable to call** and then returns to idle mode.

#### Initiate an intercom call at the telephone base

- Press **INT** on the telephone base when not in use.
  - If you have only one handset, the telephone base displays **Calling HS 1**. The handset rings and shows **Base is calling**.
  - If you have two or more handsets, the telephone base shows **Intercom to:**. Press **1-5** for **HANDSET 1** to **HANDSET 5**. The telephone base shows **Calling HS X**. The destination handset rings and shows **Base is calling**.

- To answer the intercom call on the destination handset, press **TALK/FLASH**, **INT**, or any of the dialing keys. Both devices now show **Intercom**.

- To end the intercom call at the telephone base, press **INT**, or **SPEAKER** when using the base speakerphone, or place the corded handset back to the telephone base.

**-OR-**

To end the intercom call on the

destination handset, press **OFF/CANCEL**, or place the handset back in the handset charger.

#### NOTES

- If you do not have any cordless handset registered to the telephone base, you will hear two beeps when you press **INT** on the base.
- You can cancel the intercom call before it is answered by pressing **CANCEL** or **INT**.
- If the destination handset is not powered, out of range, on a call, or does not answer the intercom call within 100 seconds, your telephone base displays **Unable to call** and then returns to idle mode.

#### Answer an incoming call during an intercom call

When you receive an outside call during an intercom call, there is an alert tone.

- Press **TALK/FLASH** on the cordless handset, the intercom call ends automatically.
- Press **SPEAKER** on the telephone base to end the intercom call. Then press **SPEAKER** again to answer the call.
- Place the corded handset back to the base. Then lift it up again to answer the call.

#### Transfer a call via intercom

Use the intercom feature to transfer an outside call to another system handset.

#### Transfer a call with a cordless handset

- During a call, press **INT**.
  - If you have only one handset, the outside call is put on hold and your handset displays **Calling base**. The telephone base rings and shows **HS 1 is calling**.
  - If you have two or more handsets, your handset displays **Intercom to:**. Press **7** for the telephone base or **1-5** for **HANDSET 1** to **HANDSET 5**. The outside call is put on hold and your handset displays **Calling HS X** or **Calling base**.

The destination handset rings and its screen displays **HS X is calling**.

- To answer the intercom call on the destination handset, press **TALK/FLASH**, **INT** or any dialing key on the destination handset. The outside call is still on hold and both handsets now display **Intercom**. You can now have a private conversation with the destination handset.

**-OR-**

To answer the call at the telephone base, press **INT**, **SPEAKER**, any of the dialing keys or lift the corded handset. The outside call is still on hold and both devices display



**Intercom.** You can now have a private intercom conversation.

- To cancel the intercom call before it is answered, press **OFF/CANCEL**, or **TALK/FLASH** or **INT** on your handset.
  - If the destination handset does not answer within 100 seconds, is in use, on a call or is out of range, the originating handset displays **Unable to call** and then reconnects to the outside call.
3. For this intercom call, you have the following options:
- You can let the destination handset join you on the outside call in a three-way conversation. Press and hold **INT** on the originating handset.
  - You can transfer the call. Press **OFF/CANCEL**, or place your handset back in the handset charger. Your handset displays **Line in use**. The destination handset is then connected to the outside call.
  - You can press **INT** to switch between the outside call (**Outside call** displays) and the intercom call (**Intercom** displays).
  - The destination handset can end the intercom call by pressing **OFF/CANCEL**, or by placing the handset back in the handset charger. The outside call continues with the original system handset.

### Transfer a call at the telephone base

1. During a call, press **INT**.
  - If you have only one handset, the outside call is put on hold and the

telephone base rings and shows **Calling HS 1**. The handset rings and displays **Base is calling**.

- If you have two or more handsets, the telephone base displays **Intercom to:**. Press **1-5** for **HANDSET 1** to **HANDSET 5**. The outside call is put on hold and the telephone base displays **Calling HS X**. The destination handset rings and its screen displays **Base is calling**.
2. To answer the call on the destination handset, press **TALK/FLASH**, **INT**, **Ⓜ**, or any of the dialing keys. The outside call is still on hold and both devices display **Intercom**. You can now have a private intercom conversation.
  3. From this intercom call, you have the following options:
    - You can let the other handset join you on the outside call in a three-way conversation. Press **MENU/SELECT** on the telephone base.
    - You can transfer the call. Press **CANCEL**, or place the corded handset back to the telephone base. Both screen displays **Intercom ended**. The destination handset is then connected to the outside call.
    - The other party can press **OFF/CANCEL** on the handset to end the intercom call. The telephone base is still connected to the outside call.

## Find handset

Page/ find handset

### ⚠ CAUTIONS

- Do not press and hold **📱 /FIND HS** for more than four seconds. It may lead to handset deregistration.
- If the handset displays **To register HS...** and **...see manual**, refer to **Add and register handset** section to register the handset back to the telephone base.

This feature helps you find all system handsets.

### To start paging

Press **📱 /FIND HANDSET** on the telephone base when it is not in use. All idle handsets ring and display **\*\* Paging \*\***.

### To end paging

Press **📱 /FIND HANDSET** again on the telephone base.

**-OR-**

Press **TALK/FLASH**, **Ⓜ**, **OFF/CANCEL** or any dialing key (**0-9**, **ⓧ** or **QUIET#**) on the handset.

**-OR-**

Place the handset in the handset charger.

### 📄 NOTES

- If you press **MUTE/DELETE** on a handset, the ringer of that handset is silenced but the paging tone continues on the other handsets.

- If a handset is accessing the answering system, on a call (intercom call or outside call), or out of range, that handset does not beep when paged.
- You cannot use the find handset feature while the telephone base is playing messages or the answering system is being accessed remotely.

## Use phone menu

1. Press **MENU/SELECT** in idle mode (when the telephone is not in use) to enter the main menu.
2. Press **▼ CID** or **▲ 📖** to scroll through menu items.
3. Press **MENU/SELECT** to select or save the highlighted item.  
**-OR-**  
Press **OFF/CANCEL** on the handset or **CANCEL** on the telephone base to cancel an operation, back up to the previous menu, or exit the menu display.



## Phonebook | Phonebook entry



The phonebook can store up to 50 entries, which are shared by all handsets. Each entry may consist of a telephone number up to 30 digits, and a name up to 15 characters.

Any additions, deletions or edits made on one handset will be reflected on other handsets.



If the telephone number in the phonebook exceeds 15 digits, a dash appears after the 14th digit and then the remaining digits are shown beginning with a dash, alternately.

### Add a phonebook entry



1. Enter the number when the phone is not in use. Press **MENU/SELECT**, then go to Step 3.  
**-OR-**  
Press **MENU/SELECT** when the telephone is not in use.
2. Press **▼ CID** or **▲**  to highlight **Phonebook**, and then press **MENU/SELECT**.
3. Press **MENU/SELECT** again to choose **Add new entry**.
4. The screen shows **Enter number**. Use the dialing keys to enter a telephone number (up to 30 digits).
  - Press **▼ CID** or **▲**  to move the cursor to the left or right.
  - Press **MUTE/DELETE** on the handset or **X/DELETE** on the telephone base to erase a digit.

- Press and hold **MUTE/DELETE** on the handset to erase all digits.
  - Press and hold **REDIAL/PAUSE** to insert a three-second dialing pause (a **P** appears).  
**-OR-**  
Press **REDIAL/PAUSE** to copy a number from the redial list. Press **▼ CID** or **▲** , or press **REDIAL/PAUSE** repeatedly to locate the desired number. Press **MENU/SELECT** to copy the displayed number.
5. Press **MENU/SELECT** to proceed to entering name.
    - The screen shows **Enter name**.
  6. Use the dialing keys to enter a name (up to 15 characters) when prompted.
    - Press a key repeatedly until the desired character shows on the screen.
    - Press **▼ CID** or **▲**  to move the cursor to the left or right.
    - Press **0** to add a space.
    - Press **MUTE/DELETE** on the handset or **X/DELETE** on the telephone base to erase a character.
    - Press and hold **MUTE/DELETE** on the handset to erase all characters.
  7. Press **MENU/SELECT** to store your new phonebook entry.

### Review the phonebook entries

1. Press **▲**  when in idle mode.
  - The screen displays the first entry in the phonebook.
2. Press **▼ CID** or **▲**  to browse through the phonebook or use the dialing keys to start a name search.

**-OR-**

1. Press **MENU/SELECT** when in idle mode.
2. Press **▼ CID** or **▲**  to scroll to **Phonebook**, then press **MENU/SELECT**.
3. Press **▼ CID** or **▲**  to scroll to **Review**, then press **MENU/SELECT**.
  - The screen shows the first entry in the phonebook.
4. Press **▼ CID** or **▲**  to scroll to browse through the phonebook.
  - Entries appear alphabetically by the first letter in the name.

### Dial a phonebook entry

1. Search for the desired entry in the phonebook (see **Review the phonebook entries** or **Alphabetical search**).
2. When the displayed number is in the correct format, press **TALK/FLASH** or  on the handset to dial.

**-OR-**

To dial the displayed entry on the telephone base, press  **/SPEAKER** or lift the corded handset.

### Delete a phonebook entry

1. While reviewing a phonebook entry (see **Review the phonebook entries** or **Alphabetical search**), press **MUTE/DELETE** on the handset or **X/DELETE** on the telephone base.
  - The screen shows **Delete entry?**.
2. Press **MENU/SELECT** to delete the displayed entry from the phonebook.
  - The handset shows **Deleting...** and then you hear a confirmation tone.

### NOTE



- Once deleted, you cannot retrieve that entry.

### Edit a phonebook entry

1. While reviewing a phonebook entry, press **MENU/SELECT**.
2. Use the dialing keys to edit the number, and then press **MENU/SELECT**.
3. Use the dialing keys to edit the name, and then press **MENU/SELECT** to save. You hear a confirmation tone.

## Alphabetical search

You can use the enhanced 3-character search to find your contacts quickly and efficiently.

1. Press **▲**  when the handset is in idle mode.
2. When an entry appears, use the dialing keys (**0-9**) to start a name search (alphabetical search).
  - The phonebook shows the first name beginning with the first letter associated with the dialing key, i.e. if there is an entry in the phonebook that begins with that letter.
  - Press **▼** **CID** or **▲**  to scroll through the entries beginning with that letter.
3. To see other names that start with the letters on the same dialing key, keep pressing the key until the desired letter is shown.
  - The names appear in alphabetical order.

For example, if you have the names Jennifer, Jessie, Kevin and Linda in your phonebook:

If you press **5 (JKL)** once, **J** and then Jennifer displays.

If you press **5 (JKL)** once, **J** displays. Press **▼**. **Jessie** displays.

If you press **5 (JKL)** twice, **K** and then **Kevin** displays.

If you press **5 (JKL)** three times, **L** and then **Linda** displays.

If you press **5 (JKL)** four times, **5** displays.

If you press **5 (JKL)** five times, **J** displays and then **Jennifer** displays again.

### **NOTE**

- If you press a dialing key (**0-9**) and no name starts with any letter on that key, the phonebook shows the entry that matches the next letter in the phonebook.

## Redial list



Each handset stores the last 10 telephone numbers dialed. Entries are shown in reverse chronological order. When there are already 10 entries, the oldest entry is deleted to make room for the new entry.

### Review a redial list entry



1. Press **REDIAL/PAUSE** in idle mode.
2. Press **▲** , **▼** **CID** or **REDIAL/PAUSE** repeatedly to browse until the desired number displays. The handset beeps twice at the end of the list.
3. Press **OFF/CANCEL** on the handset or **CANCEL** on the telephone base to exit.

### Dial a redial list entry

#### Using a cordless handset

1. Press **REDIAL/PAUSE** to enter the redial list.
2. Press **▲** , **▼** **CID** or **REDIAL/PAUSE** repeatedly to browse until the desired entry displays.
3. Press  **TALK/FLASH** or  to dial.



**-OR-**

1. Press  **TALK/FLASH** or  to take the line.
2. Press **REDIAL/PAUSE** to enter the redial list.
- 3.



4. Press **▲** , **▼** **CID** or **REDIAL/PAUSE** repeatedly to browse until the desired entry displays.

5. Press **MENU/SELECT** to dial the displayed number.

#### Using the telephone base

1. Press **REDIAL/PAUSE** to enter the redial list.
2. Press **▲** , **▼** **CID** or **REDIAL/PAUSE** repeatedly to browse until the desired entry displays.
3. When the desired entry displays, lift the corded handset or press  **/SPEAKER** to dial.

**-OR-**

1. Lift the corded handset or press  **/SPEAKER** when the phone is not in use.
2. Press **REDIAL/PAUSE**.
3. Press **▲** , **▼** **CID** or **REDIAL/PAUSE** repeatedly to browse.
4. When the desired entry displays, press **MENU/SELECT** to dial.

#### Delete a redial list entry

1. Press **REDIAL/PAUSE** in idle mode.
2. Press **▲** , **▼** **CID** or **REDIAL/PAUSE** repeatedly to browse until the desired number displays.
3. Press **MUTE/DELETE** on the handset or **X/DELETE** on the telephone base to delete the displayed number.
  - You hear a confirmation tone.

## Chain dialing



Use this feature to initiate a dialing sequence from numbers stored in the phonebook, caller ID log or redial list while you are on a call.

Chain dialing is useful if you wish to access other numbers (such as bank account numbers or access codes) from the phonebook, caller ID log or redial list.

### Access a number in the phonebook while on a call

1. Press **MENU/SELECT**.
2. Press **MENU/SELECT** to select **Phonebook**.
3. Press **▼ CID** or **▲**  to scroll to the desired entry or perform an alphabetical search, then press **MENU/SELECT** to dial the displayed number.

### Access a number in the caller ID log while on a call

1. Press **MENU/SELECT**.
2. Press **▼ CID** or **▲**  to scroll to **Caller ID log**, then press **MENU/SELECT**.
3. Press **▼ CID** or **▲**  to scroll to the desired entry, and then press **MENU/SELECT** to dial the displayed number.

### Access the redial list while on a call

1. Press **REDIAL/PAUSE**.
2. Press **▲** , **▼ CID** or **REDIAL/PAUSE** until the desired number displays.
3. Press **MENU/SELECT** to dial the displayed number.

### NOTES

- You cannot edit a phonebook entry while on a call.
- You cannot copy a caller ID log entry into the phonebook while on a call.
- You can only view the numbers in the phonebook, caller ID log or redial list while on a call and cannot edit, delete or save entries.
- Press **OFF/CANCEL** on the handset or **CANCEL** on the telephone base to exit redial list, phonebook or caller ID log while on a call.

## Caller ID

If you subscribe to caller ID service, information about each caller appears after the first or second ring. If you answer a call before the caller information appears on the screen, it will not be saved in the caller ID log.

The caller ID log stores up to 30 entries. Each entry has up to 24 digits for the phone number and 15 characters for the name.

If the telephone number has more than 15 digits, only the last 15 digits appear. If the name has more than 15 characters, only the first 15 characters are shown and saved in the caller ID log.

Entries appear in reverse chronological order. When the caller ID log is full, the oldest entry is deleted to make room for new incoming call information.

Caller ID log entries are shared by all system handsets (for multiple handset models only). Any deletions made on one handset are reflected on all other handsets.

### Review the caller ID log

Review the caller ID log to find out who called, to return the call or to copy the caller's name and number into your phonebook.



1. When the telephone is not in use, press **▼ CID** to view the caller ID log in reverse chronological order starting with the most recent call.

**-OR-**

You can also review the caller ID log by pressing **MENU/SELECT** when the telephone is not in use, then press **▼ CID** or **▲**  to scroll to **Caller ID log**. Press **MENU/SELECT** twice to select **Review**.

2. Press **▼ CID** or **▲**  to scroll through the list. You hear two beeps when you reach the beginning or end of the caller ID log.
3. Press **OFF/CANCEL** to exit the caller ID log.

### Save a caller ID log entry to the phonebook

1. While reviewing the caller ID log, press **▼ CID** or **▲**  to browse through the caller ID log.
2. When the desired entry displays, press **MENU/SELECT**.
3. Press **MENU/SELECT** again to choose **To Phonebook**.
4. When the screen shows **Enter number**, use the dialing keys to modify the telephone number (up to 30 digits).
  - Press **▼ CID** or **▲**  to move the cursor to the left or right.
  - Press and hold **REDIAL/PAUSE** to enter a 3-second dialing pause (a **P** appears).
  - Press **MUTE/DELETE** on the handset or **X/DELETE** on the telephone base to erase a digit.
  - Press and hold **MUTE/DELETE** to erase all digits.



5. Press **MENU/SELECT** to save the number in the display.
  - The screen shows **Enter name**.
6. Use the dialing keys to modify the name (up to 15 characters).
  - Press **0** to add a space.
  - Press **▼ CID** or **▲**  to move the cursor to the left or right.
  - Press **MUTE/DELETE** on the handset or **X/DELETE** on the telephone base to erase a character.
  - Press and hold **MUTE/DELETE** on the handset to erase all characters.
7. Press **MENU/SELECT** to save.
  - You hear a confirmation tone.

## NOTES

- If a number is already in the phonebook. You cannot save the same number more than once.
- If you try to save a caller ID log entry to the phonebook without a number, the handset sounds an error tone.
- If the telephone number has more than 15 digits, only the last 15 digits appear in the caller ID log. However, the telephone can still save all digits (up to 24 digits) of that telephone number from the caller ID log in the phonebook.
- You might need to change how a caller ID number is saved in the phonebook if the entry does not appear in the correct format. Caller ID numbers might appear with an area code that is not necessary for local calls, or without



- a 1 that is necessary for long distance calls.
- Caller ID log entries are shared by all system handsets. Any deletions made on one handset are reflected on all other handsets.

### Save a caller ID log entry to call block list

1. Search for the desired caller ID log entry (see **Review the caller ID log**).
2. When the desired entry displays, press **MENU/SELECT**.
3. Press **▼ CID** or **▲**  to scroll to **To Call block**, then press **MENU/SELECT**.
4. The screen displays **Enter number**. Use the dialing keys to edit the number, when necessary.
  - Press **▼ CID** or **▲**  to move the cursor to the left or right.
  - Press **MUTE/DELETE** on the handset or **X/DELETE** on the telephone base to backspace and erase a digit.
  - Press and hold **MUTE/DELETE** to erase the entire entry.
  - Press and hold **REDIAL/PAUSE** to enter a 3-second dialing pause (a **P** appears).
5. Press **MENU/SELECT** to move to the name.
  - The screen shows **Enter name**.
6. Use the dialing keys to add or edit the name.
  - Press **▼ CID** or **▲**  to move the cursor to the left or right.
  - Press **0** to add a space.

- Press **MUTE/DELETE** on the handset or **X/DELETE** on the telephone base to erase a character.
  - Press and hold **MUTE/DELETE** on the handset to erase all characters.
7. Press **MENU/SELECT** to save.

### Dial a caller ID log entry

1. Search for the desired entry in the caller ID log (see **Review the caller ID log**).
2. When the desired entry is displayed and is in the correct format for dialing:
  - Press  **TALK/FLASH** or  on the handset to dial.



**-OR-**

When the desired entry displays, press  **/SPEAKER** or lift the corded handset at the telephone base to dial.

### Delete caller ID log entries

1. Search for the desired entry in the caller ID log (see **Review the caller ID log**).
2. When the desired entry is displayed, press **MUTE/DELETE** on the handset or **X/DELETE** on the telephone base. The screen displays **Deleting....** Then you hear a confirmation tone.

### To delete all entries

1. Press **MENU/SELECT** when the telephone is not in use.
2. Press **▼ CID** or **▲**  to highlight **Caller ID log**, then press **MENU/SELECT**.
3. Press **▼ CID** or **▲**  to highlight **Delete all**, then press **MENU/SELECT**.
4. When the screen shows **Delete all?**, press **MENU/SELECT** to confirm.
  - There is a confirmation tone and the screen returns to the previous menu.

## Caller ID memory match

If the incoming telephone number matches the last 7 digits of a telephone number in your phonebook, the name that appears on the screen matches the corresponding name in your phonebook.

For example, if **Christine Smith** calls, her name appears as **Chris** if this is how you entered it into your phonebook.

### NOTE

- The number you see on your caller ID is in the format sent by the telephone service provider. It usually delivers 10-digit telephone numbers (area code plus telephone number). If the last 7 digits of the incoming telephone number do not match a number in your phonebook, the name appears as it is delivered by the telephone service provider.

## Missed call indicator

When a cordless handset or the telephone base is in idle mode and has new or missed calls, its screen shows **XX Missed calls**.

All new and missed entries are counted as missed calls. Each time you review a new caller ID log entry (indicated by **NEW** on the screen), the missed calls message goes away. When there is a new unanswered call, the missed calls message displays again. The number of missed calls includes all new and missed entries that have not been reviewed.

If you do not want to review the missed calls one by one, but still want to keep them in the caller ID log, you can press and hold **OFF/CANCEL** on the handset or **CANCEL** on the telephone base for four seconds when the handset is idle.

- You will hear a confirmation tone.
- All the entries in the caller ID log become old (reviewed already).
- Missed calls message disappears.



## Call block

If you have subscribed to caller ID service, you can set the telephone to block unknown calls and certain undesired calls. The call block list can store up to 150 entries.

When a call is blocked, the caller will hear a simulated busy tone for one ring cycle. The call recipient may pick up the call during the first ring when there is no caller ID information. Otherwise, the call is disconnected.



### Block unknown calls

All incoming calls with unknown numbers will be blocked.

1. Press **MENU/SELECT** when the phone is not in use.
2. Press **▼ CID** or **▲**  to select **Call block** and then press **MENU/SELECT**.
3. Press **▼ CID** or **▲**  to select **Calls w/o num** then press **MENU/SELECT**.
4. Press **▼ CID** or **▲**  to choose **Unblock** or **Block**, then press **MENU/SELECT**. You hear a confirmation tone.

### Add a call block list entry



1. Press **MENU/SELECT** when the phone is not in use.
2. Press **▼ CID** or **▲**  to select **Call block** and then press **MENU/SELECT**.
3. Press **MENU/SELECT** to choose **Block list**.

4. Press **▼ CID** or **▲**  to select **Add new entry** then press **MENU/SELECT**.
5. When **Enter number** displays, use the dialing keys to enter the number. **-OR-** Copy a number from the redial list by pressing **REDIAL/PAUSE** and then press **▲** , **▼ CID** or **REDIAL/PAUSE** repeatedly to select a number. Press **MENU/SELECT** to copy the number.
6. Press **MENU/SELECT** to move on to enter the name. The handset displays **Enter name**.
7. Use the dialing keys to enter the name. Additional key presses show other characters of that particular key. The first character of every word is capitalized.
8. Press **MENU/SELECT** to save. You hear a confirmation tone.

### While entering names and numbers, you can:

- Press **MUTE/DELETE** on the handset or **X/DELETE** on the telephone base to backspace and erase a digit or character.
- Press and hold **MUTE/DELETE** to erase the entire entry.
- Press **▼ CID** or **▲**  to move the cursor to the left or right.
- Press and hold **REDIAL/PAUSE** to insert a dialing pause (for entering numbers only).
- Press **0** to add a space (for entering names only).

## Review call block list

1. Press **MENU/SELECT** when the phone is not in use.
2. Press **▼ CID** or **▲**  to select **Call block** and then press **MENU/SELECT**.
3. Press **MENU/SELECT** to choose **Block list**.
4. Press **MENU/SELECT** to choose **Review**.
5. Press **▼ CID** or **▲**  to browse through the call block list.



## Edit a call block list entry

1. Search for the desired entry in the call block list (see **Review call block list**).
2. When the desired entry appears, press **MENU/SELECT**. The handset displays **Enter number** and the stored number.
3. Use the dialing keys to edit the number, then press **MENU/SELECT**. The handset displays **Enter name** and then the stored name.
4. Use the dialing keys to edit the name. Additional key presses show other characters of that particular key. The first character of every word is capitalized.
5. Press **MENU/SELECT** to save. You hear a confirmation tone.

## Save a caller ID log entry to the call block list

1. When in the caller ID log, press **▼ CID** or **▲**  to browse.
2. When the desired caller ID log entry displays, press **MENU/SELECT** twice to choose **To Call block**. The screen displays **Enter number** and the stored number.
3. Use the dialing keys to modify the number, if necessary. Then press **MENU/SELECT**. The screen displays **Enter name** and then the stored name.
4. Use the dialing keys to modify the name, if necessary. Then press **MENU/SELECT** to save. You hear a confirmation tone.

## Unblock a telephone number

1. Press **MENU/SELECT** when the phone is not in use.
2. Press **▼ CID** or **▲**  to select **Call block** and then press **MENU/SELECT**.
3. Press **MENU/SELECT** to choose **Block list**.
4. Press **MENU/SELECT** to choose **Review**.
5. Press **▼ CID** or **▲**  to browse through the call block list.
6. When the desired call block list entry displays, press **MUTE/DELETE** on the handset or **X/DELETE** on the telephone base and you hear a confirmation tone.

## Mute first ring

Your telephone rings once for blocked calls. You can choose to mute the first ring for all incoming calls, so that there will be no ring for blocked calls. By default, the first ring is set to On.

1. Press **MENU/SELECT** when the telephone is not in use.
2. Press **7464#** on the handset or on the telephone base.
3. Press **▼ CID** or **▲**  to choose **First ring:On** to keep the first ring, or **First ring:Off** to mute the first ring.
4. Press **MENU/SELECT** to save. You hear a confirmation tone.

## NOTE



- If you have muted the first ring, you will hear one ring less before the answering system and voicemail answer the incoming calls.

## Answering system

### [Difference between the built-in answering system and voicemail service](#)

Your telephone has separate indicators for two different types of voice messages: those recorded on its built-in digital answering system and those recorded in your telephone service provider's voicemail (fees may apply). Your telephone's built-in digital answering system messages and voicemail messages are separate.

The main differences between them are: [Use your built-in answering system](#)

Category	Built-in answering system	Voicemail from telephone service
Storage	Messages are stored in the telephone base.	Messages are stored in a server or system provided by your telephone service.
	Your messages will not be deleted automatically.  You have to delete your messages manually.	Your messages may be automatically deleted after a period of time.  Contact your telephone service provider for more details.
Method to retrieve messages	When you received new messages, screen displays <b>XX new messages.</b>	When you received new messages, the screen displays  and <b>New voicemail.</b>
	To retrieve messages, usually there are two ways:  <ul style="list-style-type: none"> <li>• Press  on the telephone base; or</li> <li>• Access remotely with an access code.</li> </ul>	

[Use your built-in answering system](#)

### New message indication

If **XX new messages** display on the handsets, there are new messages in the built-in answering system.

Message window display	Description
0	There are no messages in the answering system.
0 (flashing)	After a power failure, the number in the message window flashes to indicate that the date and time need to be set.
1-99	<ul style="list-style-type: none"> <li>• Total number of messages and memos.</li> <li>• Current message number during old message playback.</li> </ul>
1-99 (flashing)	<ul style="list-style-type: none"> <li>• Total number of new messages and memos. The number flashes when there are new messages that have not been reviewed.</li> <li>• Current message number during new message playback.</li> <li>• After a power failure, the number in the message window flashes to indicate that the date and time need to be set.</li> </ul>
1-99 & F (alternating)	Memory is full. Messages must be deleted before new messages can be recorded.
--	<ul style="list-style-type: none"> <li>• The answering system is being programmed by a system handset.</li> <li>• The answering system is answering a call or recording a memo or announcement.</li> <li>• The answering system is being accessed remotely.</li> <li>• The phonebook or caller ID log is being accessed by a system handset.</li> </ul>
0-6	Telephone base ringer volume while adjusting.
1-8	Speaker volume level of the telephone base while adjusting.

[Turn on or off the answering system](#)









The answering system must be turned on to answer and record messages.

When the answering system is turned on, the  **ANS ON/OFF** light on the telephone base turns on and **ANS ON** displays on the handset.

### Turn the answering system on or off with the telephone base

Press  **ANS ON/OFF** to turn the answering system on or off. When the answering system is turned on, it announces, *"Calls will be answered."* When the answering system is turned off, it announces, *"Calls will not be answered."*



### Turn the answering system on or off with a handset

1. Press **MENU/SELECT** in idle mode.
2. Press  **CID** or   to highlight **Answering sys**, then press **MENU/SELECT**.
3. Press  **CID** or   to highlight **Answer on/off**, then press **MENU/SELECT**.
4. Press  **CID** or   to highlight **On or Off**, then press **MENU/SELECT** to save.

[Playback messages](#)

You can listen to messages at the telephone base or on a cordless handset. When playback begins, the total number of messages is announced. Before each message, you hear the day and time of the recording. After the last message, you hear, *"End of messages."* Make sure you set the date and time correctly. Refer to [Set date and time](#) for more details.

### To listen to messages at the base

1. Press  on the base to listen to the messages. If you have new messages, the telephone plays only the new messages (oldest first). If there are no new messages, the telephone plays back all messages (oldest first).
  2. The system announces the number of messages, then begins playback. The message sequence is shown on the message window.
  3. Press  to stop the playback.
- OR-**
1. Press **MENU/SELECT** when the phone is not in use.
  2. Press **MENU/SELECT** to select **Play messages**. The system plays the messages.



## Options during playback

- Press **VOL ▼** or **VOL ▲** to adjust the message playback volume.
  - Press **▶▶** to skip to the next message.
  - Press **◀◀** to repeat the message currently playing.
  - Press **◀◀** twice to listen to the previous message.
  - Press **✕** to delete the current message. The system advances to the next message.
  - Press **▶/■** to stop the playback.
- Press **▲/VOLUME/▼** to adjust the message playback volume.
  - Press **6** to skip to the next message.
  - Press **4** to repeat the message currently playing. Press **4** twice to listen to the previous message.
  - Press **3** or **MUTE/DELETE** to delete the current message.
  - Press **OFF/CANCEL** to stop the playback.

## To listen to messages at the handset

1. Press **MENU/SELECT** on the telephone is not in use.
2. Press **MENU/SELECT** again to select **Play messages**. If you have either new or old messages, the messages play automatically.
3. The system announces the number of messages, then begins playback. The message sequence is shown on the handset's screen.
4. Press **OFF/CANCEL** to stop the playback.

## Options during playback

- Press **🔊** to play the messages through the handset earpiece.
- Press **🔊** again to return to playing messages through the speakerphone.

## Adjust listening volume during message playback

### Using the base

- Press **VOL ▼** or **VOL ▲** to adjust the message playback volume

### Using a handset

- Press **▲/VOLUME/▼** to adjust the message playback volume.

## Skip to the next message

### Using the base

- Press **▶▶** to skip to the next message.

### Using a handset

- Press **6** to skip to the next message.

## Repeat the playing message

### Using the base

- Press **◀◀** to repeat the message currently playing.

### Using a handset

- Press **4** to repeat the message currently playing.

## Listen to the previous message

### Using the base

- Press **◀◀** twice to listen to the previous message.

### Using a handset

- Press **4** twice to listen to the previous message.

## Stop the message playback

### Using the base

- Press **▶/■** to stop the playback.

### Using a handset

- Press **OFF/CANCEL** to stop the playback.

## Delete a message

You can only delete old (reviewed) messages. You cannot delete new messages until you review them. You cannot retrieve deleted messages.

### To delete a message with the base

1. Press **▶/■** on the telephone base to listen to the message.
2. Press **✕** to delete the current message. The system advances to the next message.

## Using a handset



1. Press **MENU/SELECT** when the telephone is not in use. The handset displays **Play messages**.
2. Press **MENU/SELECT**. When you have messages, the handset displays **Playing...** and then **Repeat [4] Del [3] Skip [6]** and it announces the total number of messages. When you have no message in the answering system, the handset displays **No messages** and it announces, *"You have no message."*
3. While the message is playing, press **3** to delete the playing message. The handset announces, *"Message deleted,"* and then advances to the next message.

## Delete all messages

### Using the base

1. Press **X** in idle mode. The telephone announces, *"To delete all old messages, press DELETE again."*
2. Press **X** again. All previously reviewed messages are erased and the telephone announces, *"All old messages deleted."*

### Using a handset

1. Press **MENU/SELECT** in idle mode.
2. Press **▼ CID** or **▲**  to highlight **Answering sys**, then press **MENU/SELECT**.
3. Press **▼ CID** or **▲**  to highlight **Delete all old**, then press **MENU/SELECT**.
4. Press **MENU/SELECT** to confirm. The handset displays **Deleting...**, then **No old messages** and then returns to the previous menu. You hear a confirmation tone.

## Answering system remote access

You can reach your answering system remotely by dialing your home telephone number from any touch-tone telephone.

1. Dial your telephone number from any touch-tone telephone.
2. Once the system plays your announcement, enter the two-digit remote access code (**19** is the default code).
  - The system automatically announces the number of new or old messages (if any), and then begins to play them.

You can also enter the following remote commands.



Commands	Description
1	Play all messages.
2	Play new messages only.
3	Delete the current message (during playback).
33	Delete all old messages.
4	Repeat the current message (during playback).
5	Stop.
*5	Listen to a list of remote commands.
6	Skip to the next message (during playback).
*7	Record a new announcement.
8	Hang up the call.
0	Turn the answering system on or off.

3. Hang up or press **8** to end the call.

## NOTES



- If you do not press any key after you enter the remote access code, all new messages play. If there are no new messages, all old messages play.
- Once the new messages have played, the telephone announces the help menu options. If you do not press any key within 20 seconds, the remote access call automatically disconnects.
- When the answering system is turned off, the telephone answers after 10 rings, and announces, *"Please enter your remote access code."*
- When the memory is full, the answering system answers incoming calls after 10 rings and announces, *"Memory is full. Enter your remote access code."*

## Call intercept while using answering system

When a caller is leaving a message on your answering system, you can stop recording and talk to the caller by pressing  **TALK/FLASH** or  on the handset, or press  **/SPEAKER** on the telephone base.

## Recording memo

Memos are your own recorded messages used as reminders for yourself or others using the same answering system. You can record your own memos using a system handset. Playback and delete them in the same way as incoming messages.



1. Press **MENU/SELECT** in idle mode.
2. Press **▼ CID** or **▲**  to highlight **Answering sys**, then press **MENU/SELECT**.
3. Press **▼ CID** or **▲**  to choose **Record memo** and then press **MENU/SELECT**.
4. The system announces, *"Record after the tone. Press 5 when you are done."* After the tone, speak towards the microphone.
5. Press **5** when you finish recording. The handset announces *"Recorded."*

### NOTES

- If you record a memo when the answering system memory is full, the system announces, *"Memory is full."*
- Each memo can be up to three minutes in length. Memos shorter than two seconds are not recorded.

## Turn on or off the call screening

Use this feature to choose whether incoming messages can be heard over the telephone base when they are being recorded. If you turn call screening on, you hear the incoming message.

1. Press **MENU/SELECT** in idle mode.
2. Press **▼ CID** or **▲**  to highlight **Answering sys**, then press **MENU/SELECT**.
3. Press **▼ CID** or **▲**  to highlight **Ans sys setup**, then press **MENU/SELECT** twice to select **Call screening**.
4. Press **▼ CID** or **▲**  to choose between **On** and **Off**, then press **MENU/SELECT** to save.

## Screen a call with answering system

### Screen calls at the base

If the answering system and call screening are turned on, the announcement and the incoming message broadcast at the telephone base while the call is answered by the answering system.

### Options while a message is being recorded

- Press **VOL ▼** or **VOL ▲** to adjust the call screening volume.
- Press **▶/■** to temporarily silence the call screening.
- Press **▶/■** or **VOL ▲** to temporarily turn on the call screening if call screening is set to Off.

## Screen calls at the cordless handset

If the answering system is on and a call is being answered by the answering system, the handset shows **To screen call press [SELECT]**. Press **MENU/SELECT** to screen the call on your handset. The handset shows the caller's information. If you do not subscribe to caller ID service, the handset shows **Screening....**

### Options while a message is being recorded

- Press **▲/VOLUME/▼** on the handset to adjust the call screening volume.
- Press  to switch between speakerphone mode and handset mode.

## Announcement

Your outgoing announcement plays when calls are answered by the answering system. The telephone has a default outgoing announcement, *"Hello, please leave a message after the tone."* You can use this announcement, or record your own.

## Record a new outgoing announcement

The announcement can be up to 90 seconds in length.

1. Press **MENU/SELECT** in idle mode.
2. Press **▼ CID** or **▲**  to scroll to **Answering sys**, then press **MENU/SELECT**.
3. Press **MENU/SELECT** to select **Announcement**.
4. The screen displays **Play [2] Del [3] Rec [7]** and it announces, *"To play, press 2. To record, press 7."* Press **7** to record.
5. The telephone announces, *"Record after the tone. Press 5 when you are done."* and it displays **Recording... Stop [5]**.
6. After the tone, speak towards the handset microphone.

Press **5** when finished. The telephone plays back the recorded announcement. Press **5** or **OFF/CANCEL** to stop the playback at any time.

To listen to the recorded announcement again, wait after playback has completed, then press **2**.

## NOTE

- Announcements shorter than two seconds will not be recorded.

### Play your announcement

1. Press **MENU/SELECT** in idle mode.
2. Press **▼ CID** or **▲**  to scroll to **Answering sys**, then press **MENU/SELECT**.
3. Press **MENU/SELECT** to select **Announcement**.
4. The screen displays **Play [2] Del [3] Rec [7]** and it announces, *"To play, press 2. To record, press 7."* Press **2** to play the current announcement.

### Options during playback

- Press **▲/VOLUME/▼** on the cordless handset, or **VOL ▼** or **VOL ▲** on the telephone base to adjust the listening volume.
- Press **5** or **OFF/CANCEL** on the handset or **CANCEL** on the telephone base to stop at any time.
- Press  on the handset to switch between the speakerphone and the handset earpiece.

### Delete your announcement

1. Press **MENU/SELECT** in idle mode.
2. Press **▼ CID** or **▲**  to scroll to **Answering sys**, then press **MENU/SELECT**.
3. Press **MENU/SELECT** to select **Announcement**.
4. The screen displays **Play [2] Del [3] Rec [7]** and it announces, *"To play, press 2. To record, press 7."* Press **3** to delete your recorded announcement. The handset displays **Annc deleted**.

## NOTE

- After you deleted your own recorded announcement, the answering system answers calls with the default announcement.

## Voicemail (via Telephone service provider)

When you received a voicemail, the handset and the telephone base display  and **New voicemail**.

To retrieve, you typically dial an access number provided by your telephone service provider, followed by a security code or PIN.

Some service providers bundle or combine multiple services like voicemail and call waiting, so you may not be aware that you have voicemail. To check what services you have and how to access them, contact your telephone service provider.



## NOTE

- After you have listened to all new voicemail messages, the indicators on the screen turn off automatically.

### Turn off the new voicemail indicators

If you have retrieved your voicemail while away from home, and the handset and the telephone base still display the new voicemail indicators, use this feature to turn off the indicators.

This feature only turns off the displayed **New voicemail** and the ; it does not delete your voicemail messages. As long as you have new voicemail messages, your telephone service provider continues to send the signal to turn on the indicator.

1. Press **MENU/SELECT** in idle mode.
2. Press **▼ CID** or **▲**  to highlight **Settings**, then press **MENU/SELECT**.
3. Press **▼ CID** or **▲**  to highlight **Clr voicemail**, then press **MENU/SELECT** to turn the voicemail indicator off.

## NOTES

- Your telephone service provider voicemail might alert you to new messages with a stutter (broken) dial tone. Contact your telephone service provider for more details.
- For information about using your voicemail service, contact your telephone service provider.

# Configure | Settings

## Answering system settings

### Set your built-in answering system

The answering system can record and store up to 99 messages. Each message can be up to 3 minutes in length. The total storage capacity for the announcement, messages and memos is approximately 22 minutes. The actual recording time depends on individual message characteristics. Messages remain available for replay until you delete them.



If the answering system has less than 3 minutes of recording time left, *"Less than 3 minutes to record"* is announced before the message playback and **Rec mem low** appears on the handset screen.

If the memory is full, the answering system announces, *"Memory is full."* The number of messages and **F** flash, alternatively, in the message window, and **Rec mem full** appears on the handset screen. You must delete some messages before recording new ones.

Your answering system allows you to set your announcement, to save and delete messages, activate call screening, to set number of rings before pick up, and to access remotely.

### Set answering system through voice guide

This feature is an alternative way for you to do the basic setup of the answering system. You can follow the voice guide to record your own announcement, set the number of rings, and set the message alert tone.

1. Press **MENU/SELECT** when the telephone is not in use.
2. Press **▼ CID** or **▲**  to highlight **Answering sys**, then press **MENU/SELECT**.
3. Press **▼ CID** or **▲**  to highlight **Voice guide**, then press **MENU/SELECT**. You hear a voice prompt, *"Hello! This voice guide will assist you with the basic setup of your answering system."*
4. Set up your answering system by inputting designated numbers, as instructed in the voice guide.





### NOTES

- You can press **OFF/CANCEL** on the handset to quit the voice guide at any time.
- After a power outage, the telephone prompts you to set the date and time. After the date and time setting is done or skipped, the telephone then prompts if you want to set up the answering system via voice guide. Press **MENU/SELECT** to start the setup.

### Set remote access code





To access your answering system remotely from any touch-tone phone, you need to enter a two-digit number (**00-99**). By default, the remote access code is **19**.

#### To change the remote access code:

1. Press **MENU/SELECT** in idle mode.
2. Press **▼ CID** or **▲**  to highlight **Answering sys**, then press **MENU/SELECT**.
3. Press **▼ CID** or **▲**  to highlight **Ans sys setup**, then press **MENU/SELECT**.
4. Press **▼ CID** or **▲**  to highlight **Remote code**, then press **MENU/SELECT**.
5. Use the dialing keys to enter a two-digit number.  
**-OR-**  
Press **▼ CID** or **▲**  to scroll to a desired two-digit number.
6. Press **MENU/SELECT** to confirm.

### Turn on or off the message alert tone

When the message alert tone is set to **On**, and there is at least one new message, the telephone base beeps every 10 seconds. The tone stops when all new messages have been reviewed.

1. Press **MENU/SELECT** in idle mode.
2. Press **▼ CID** or **▲**  to highlight **Answering sys**, then press **MENU/SELECT**.
3. Press **▼ CID** or **▲**  to highlight **Ans sys setup**, then press **MENU/SELECT**.
4. Press **▼ CID** or **▲**  to highlight **Msg alert tone**, then press **MENU/SELECT**.
5. Press **▼ CID** or **▲**  to choose **On** or **Off**, then press **MENU/SELECT**.

### NOTE

- The message alert tone beeps only if all the following conditions are met.
  - Answering system is on.
  - Message alert tone setting is on.
  - There are new messages.

## Area code settings



### Set home area code

If you dial seven digits to make a local call (no area code required), enter your area code into the telephone as the home area code. When you receive a call from within your home area code, the caller ID log only displays the seven digits of the telephone number.

This feature makes it easy for you to place a call from the caller ID log. If you dial 10 digits to make a local phone call, do not use this home area code feature.

If you do, you cannot place local calls from your caller ID log, as they will have only seven digits.

#### To set the home area code:

1. Press **MENU/SELECT** in idle mode.
2. Press **▼ CID** or **▲**  to highlight **Settings**, then press **MENU/SELECT**.
3. Press **▼ CID** or **▲**  to highlight **Home area code**, then press **MENU/SELECT**.
4. Use the dialing keys to enter a three-digit home area code.
  - Press **▼ CID** or **▲**  to move the cursor to the left or right.
  - Press **MUTE/DELETE** on the handset or **X/DELETE** on the telephone base to erase a digit.
  - Press and hold **MUTE/DELETE** on the handset to erase all digits.
5. Press **MENU/SELECT** to confirm.

### NOTE

- If in the future, your telephone service provider requires you to dial ten digits to make a local call (area code + telephone number), you need to delete your home area code. While the home area code is displaying in Step 4, press and hold **MUTE/DELETE**. The home area code is now restored to its default setting of \_ \_ \_(empty). Press **MENU/SELECT** to save.

## Dial modes

### Temporary tone dialing

If you have pulse (rotary) service only, you can switch from pulse to touch-tone dialing temporarily during a call. This is useful if you need to send touch-tone signals to access your telephone banking or long distance services.



#### During a call

1. Press **TONE X** on the handset.
2. Use the dialing keys to enter the relevant number. The telephone sends touch-tone signals.
3. The telephone automatically returns to pulse dialing after you end the call.

### Set dial mode

The dial mode is preset to tone dialing. If you have pulse (rotary) service, you must change the dial mode to pulse dialing before using the telephone.

#### To set the dial mode

1. Press **MENU/SELECT** in idle mode.
2. Press **▼ CID** or **▲**  to highlight **Settings**, then press **MENU/SELECT**.
3. Press **▼ CID** or **▲**  to highlight **Dial mode**, then press **MENU/SELECT**.
4. Press **▼ CID** or **▲**  to choose **Touch-tone** or **Pulse**, then press **MENU/SELECT**.



### NOTE

- If you have dial pulse (rotary) dialing service only, refer to **Temporary tone dialing** to temporarily switch from pulse to touch-tone dialing during a call.

## Ringer

### Set ringer tone

You can choose from different ringer tones for each handset and the telephone base.

1. Press **MENU/SELECT** in idle mode.
2. Press **▼ CID** or **▲**  to highlight **Ringers**, then press **MENU/SELECT**.
3. Press **▼ CID** or **▲**  to select **Ringer tone**, then press **MENU/SELECT**.
4. Press **▼ CID** or **▲**  to sample each ringer tone.
5. Press **MENU/SELECT** to save. You hear a confirmation tone.



### NOTE

- If you turn off the ringer volume, you will not hear ringer tone samples.

## Set ringer volume

### Handset ringer volume

You can adjust the handset ringer volume level, or turn the ringer off.



1. Press **MENU/SELECT** in idle mode.
2. Press **▼ CID** or **▲**  to highlight **Ringers**, then press **MENU/SELECT** twice.
3. Press **▼ CID** or **▲**  to select **Ringer volume**, and then press **MENU/SELECT**.
4. Press **▼ CID** or **▲**  to sample each ringer volume level.
5. Press **MENU/SELECT** to save.

### Telephone base ringer volume

When the telephone base is idle, press **▼ VOL** or **▲ VOL** on the telephone base to adjust the ringer volume.

When you set the ringer volume to zero, the base ringer is off. The telephone base announces, "*Base ringer is off.*"

### NOTES



- If the ringer volume is set to **Off**, the idle screen displays .
- When the ringer volume is set to **Off**, the handset still rings when you press  / **FIND HANDSET** at the telephone base.

## Set date and time

The answering system announces the day and time of each message prior to playing it. Before using the answering system, set the date and time as follows. If you subscribe to caller ID service, the day, month and time are set automatically with each incoming call. However, the year must be correct so that the day of the week can be calculated from the caller ID information.

After handset registration or a power failure, the handset will prompt you to set the date and time.

### To set the date and time manually



1. Press **MENU/SELECT** in idle mode.
2. Press **▼ CID** or **▲**  to highlight **Set date/time**, then press **MENU/SELECT**.
3. Use the dialing keys (**0-9**) to enter the month (**MM**), date (**DD**) and year (**YY**). Then press **MENU/SELECT**.
4. Use the dialing keys (**0-9**) to enter the hour (**HH**) and minute (**MM**). Then press **▼ CID** or **▲**  to choose **AM** or **PM**.
5. Press **MENU/SELECT** to save your setting. You hear a confirmation tone.

## Set languages

### Set LCD language

You can select English, French, or Spanish to be used for all screen displays.

### To select the LCD language

1. Press **MENU/SELECT** in idle mode.
2. Press **▼ CID** or **▲**  to highlight **Settings**, and then press **MENU/SELECT**.
3. Press **MENU/SELECT** to select **LCD language**.
4. Press **▼ CID** or **▲**  to highlight **English, Français** or **Español**, and then press **MENU/SELECT** to confirm.

### NOTE





- If you accidentally change the LCD language to French or Spanish, you can reset it back to English without going through the French or Spanish menus. Press **MENU/SELECT** in idle mode, then enter **\*364#**. There is a confirmation tone.

## Set voice language

### NOTE

- This feature is exclusive for Canada version.

The voice prompt language is preset to English. You can select English or French to be used for the voice prompts in your answering system.

1. Press **MENU/SELECT** in idle mode.
2. Press **▼ CID** or **▲**  to highlight **Answering sys**, and then press **MENU/SELECT**.
3. Press **▼ CID** or **▲**  to highlight **Ans sys setup**, and then press **MENU/SELECT**.
4. Press **▼ CID** or **▲**  to highlight **Voice language**, and then press **MENU/SELECT**.
5. Press **▼ CID** or **▲**  to highlight **English** or **Français**, and then press **MENU/SELECT** to confirm.





## Sound settings

### Set number of rings

You can set the answering system to answer an incoming call after two, three, four, five or six rings; or toll saver.

If you choose toll saver, the answering system answers a call after two rings when you have new messages, or after four rings when you have no new messages. This enables you to check for new messages and avoid paying unnecessary long distance charges if you are calling from outside your local area.

#### To set the number of rings

1. Press **MENU/SELECT** in idle mode.
2. Press **▼ CID** or **▲**  to highlight **Answering sys**, then press **MENU/SELECT**.
3. Press **▼ CID** or **▲**  to highlight **Ans sys setup**, then press **MENU/SELECT**.
4. Press **▼ CID** or **▲**  to highlight **# of rings**, then press **MENU/SELECT**.
5. Press **▼ CID** or **▲**  to choose from **6**, **5**, **4**, **3**, **2** or **Toll saver**.
6. Press **MENU/SELECT** to save.

#### NOTE

- If you have muted the first ring, you will hear one ring less before the answering system answers the incoming calls.

### Set QUIET mode

When **QUIET** mode is turned on, the telephone silences all sounds during the set period of time (1-12 hours). However, the handset locator paging tone and any sound-generating operations initiated by users, such as making calls using the speakerphone or setting ringer volume, will sound as normal. After you turn on **QUIET** mode, this feature activates immediately and the answering system turns on automatically.

When **QUIET** mode is on, the answering system takes calls and records messages without broadcasting them.

#### To turn QUIET mode on

1. Press and hold **QUIET #** when the telephone is not in use.
  2. The screen displays **Quiet: \_ \_ hours**. Use the dialing keys (**0-9**) to enter the desired duration (1-12).
  3. Press **MENU/SELECT** to save. You hear a confirmation tone.
- The screen displays **Quiet mode on** and .

#### NOTE

- When you change the settings of the ringer tone or ringer volume, you can still hear the samples even if the quiet mode is on.

#### To turn QUIET mode off

Press and hold **QUIET #** when the telephone is not in use. The screen displays **Quiet mode off** briefly and then returns to idle.

### Set listening volume

While on a call or message playback, you can adjust the listening volume on the handset or telephone base.

#### To adjust the listening volume of a handset

- Press **▲/VOLUME/▼** on the handset while on a call.

#### To adjust the listening volume of the telephone base



- Press **▼VOL** or **▲VOL** while listening to the message playback on the telephone base.

### Set key tone

The handset is set to beep with each key press. You can adjust the key tone volume or turn it off.

If you turn off the key tone, there are no beeps when you press keys.

#### To set the key tone

1. Press **MENU/SELECT** in idle mode.
2. Press **▼ CID** or **▲**  to highlight **Settings**, then press **MENU/SELECT**.
3. Press **▼ CID** or **▲**  to highlight **Key tone**, then press **MENU/SELECT**.
4. Press **▼ CID** or **▲**  to select **On** or **Off**.
5. Press **MENU/SELECT** to confirm.



## Voicemail settings







### Set speed dial voicemail number

This feature lets you save your voicemail number for quick access when you press and hold the  **1** key.

#### To set your voicemail number

1. Press and hold  **1** when the phone is not in use.
2. Use the dialing keys to enter the voicemail number (up to 30 digits).
3. Press **MENU/SELECT** to save. Then the handset dials the saved voicemail number.

- OR -

1. Press **MENU/SELECT** in idle mode.
2. Press  **CID** or   to highlight **Settings**, then press **MENU/SELECT**.
3. Press  **CID** or   to highlight **Voicemail #**, then press **MENU/SELECT**.
4. Use the dialing keys to enter the voicemail access number (up to 30 digits) provided by your telephone service provider.
5. Press **MENU/SELECT** to confirm.

## Add and register handset

You can add new **VG208-0** handsets (purchased separately) to your **VG208/VG208-2** telephone system. Your telephone system supports a maximum of 5 handsets.

Each handset must be registered with the telephone base before use. When first purchased, each expansion handset displays **To register HS...** and ... **see manual** alternately.

#### NOTES

- Charge the new handset without interruption for at least 30 minutes before registering it to the telephone base.
- You cannot register a handset if any other system handset is in use.

#### To register a handset to VG208/VG208-2 telephone base

1. Press and hold  /**FIND HANDSET** on the telephone base for about four seconds until the **IN USE** light turns on and it shows **Registering....**
2. Press **QUIET #** on the handset. The handset shows **Registering....** Both the telephone base and cordless handset show **Registered**, and you hear a beep when the registration process completes. This process takes about 60 seconds.

If registration fails, **Failed** appears on the handset screen. The handset shows **To register HS...** and ... **see manual** alternately, and the telephone base returns to idle mode. This may take up to five minutes to occur. Start again from Step 1.

## General product care

### Taking care of your telephone

Your cordless telephone contains sophisticated electronic parts, so it must be treated with care.

#### Avoid rough treatment

Place the handset down gently. Save the original packing materials to protect your telephone if you ever need to ship it.

#### Avoid water

Your telephone can be damaged if it gets wet. Do not use the handset outdoors in the rain, or handle it with wet hands. Do not install the telephone base near a sink, bathtub or shower.

#### Electrical storms

Electrical storms can sometimes cause power surges harmful to electronic equipment. For your own safety, take caution when using electrical appliances during storms.

#### Cleaning your telephone

Your telephone has a durable plastic casing that should retain its luster for many years. Clean it only with a dry non-abrasive cloth. Do not use dampened cloth or cleaning solvents of any kind.

# Technical specifications

Frequency control	<ul style="list-style-type: none"> <li>• Crystal controlled PLL synthesizer</li> </ul>
Transmit frequency	<ul style="list-style-type: none"> <li>• Handset: 1921.536-1928.448 MHz</li> <li>• Telephone base: 1921.536-1928.448 MHz</li> </ul>
Channels	<ul style="list-style-type: none"> <li>• 5</li> </ul>
Nominal effective range	<ul style="list-style-type: none"> <li>• Maximum power allowed by FCC and IC. Actual operating range may vary according to environmental conditions at the time of use.</li> </ul>
Power requirement	<ul style="list-style-type: none"> <li>• <b>Handset:</b> 2.4V Ni-MH battery</li> <li>• <b>Telephone base:</b> 6V DC @ 0.4A</li> <li>• <b>Charger:</b> 6V DC @ 0.4A</li> </ul>
Memory	<ul style="list-style-type: none"> <li>• <b>Phonebook:</b> 50 memory locations; up to 30 digits and 15 characters</li> <li>• <b>Caller ID log:</b> 30 memory locations; up to 24 digits and 15 characters</li> <li>• <b>Call block:</b> 150 entries</li> </ul>

When it is fully charged, you can expect the following performance.

Operation	Operating time*
Talk time (cordless handset)	<ul style="list-style-type: none"> <li>• 7 hours</li> </ul>
Standby	<ul style="list-style-type: none"> <li>• 5 days</li> </ul>

\* Operating times vary depending on your actual use and the age of the battery.

## DECT 6.0 digital technology

The VTech DECT 6.0 products offer unsurpassed range performance and sound clarity. This is achieved through a unique antenna design and advances in noise-filtering technology. An independent laboratory has confirmed that VTech DECT 6.0 products perform up to 45% better in range competitions against similarly equipped phones of the leading competition. Now, calls can be taken in the basement, backyard and garage with exceptional sound quality.

### Telephone operating range

This cordless telephone operates within the maximum power allowed by the Federal Communications Commission (FCC). Even so, this handset and telephone base can communicate over a certain distance – which can vary with the locations of the telephone base and handset, the weather, and the construction of your home or office.

### Redefining long range coverage and clarity

This telephone base comes with an antenna which gives much better clarity and covers a longer range than before.

## Simulated full-duplex handset and base speakerphones

This simulated full-duplex speakerphone on your handset and telephone base allow both ends of a call to speak and be heard at the same time. Optimal performance is subject to external factors and individual usage.

## Frequently asked questions

Below are the questions most frequently asked about the cordless telephone. If you cannot find the answer to your question, visit our U.S. website at [www.vtechphones.com](http://www.vtechphones.com) or call **1 (800) 595-9511** for customer service. In Canada, go to [phones.vtechcanada.com](http://phones.vtechcanada.com) or call **1 (800) 267-7377**.

My telephone does not work at all.	Make sure the telephone base is installed properly, and battery is installed and charged correctly. For optimum daily performance, return the handset to the telephone base after use.
The display shows <b>No line</b> . I cannot hear the dial tone.	<p>Disconnect the telephone line cord from your telephone and connect it to another telephone. If there is no dial tone on that other telephone either, then the telephone line cord may be defective. Try installing a new telephone line cord.</p> <p>If changing the telephone line cord does not help, the wall jack (or the wiring to this wall jack) may be defective. Contact your telephone service provider.</p> <p>You may be using a new cable or VoIP service, the existing telephone jacks in your home may no longer work. Contact your service provider for solutions.</p>

I cannot dial out.	Make sure there is a dial tone before dialing. It is normal if the handset takes a second or two to synchronize with the telephone base before producing a dial tone. Wait an extra second before dialing.
	Eliminate any background noise. Mute the handset before dialing, or dial from another room in your home with less background noise.
The display shows <b>To register HS...</b> and <b>...see manual</b> alternately. The handset does not work at all.	The handset is deregistered from the telephone base. Place the handset in the telephone base to register it back. The handset shows <b>Registered</b> and you hear a beep when the registration process completes. This process takes about 60 seconds to complete.
The display shows <b>Low battery</b> .	Place the handset in the handset charger for charging.
The battery does not charge in the handset or the handset battery does not accept charge.	Make sure the handset is placed in the handset charger correctly.
	If the battery is completely depleted, charge the battery for at least 30 minutes before use. You may need to purchase a new battery.
The telephone does not ring when there is an incoming call.	Make sure the ringer volume is not set to off.
	The handset may be too far from the telephone base. Move it closer to the telephone base.
My handset beeps and is not performing normally.	Move the handset closer to the telephone base. It may be out of range.
I hear noise on the cordless handset and the keys do not work.	Make sure the telephone line cord is plugged in securely.

I hear other calls when using the telephone.	Disconnect the telephone base from the telephone wall jack. Plug in a different telephone. If you still hear other calls, the problem is probably in the wiring or telephone service. Contact your telephone service provider.
There is interference during a telephone conversation. My calls fade out when I am using the cordless handset.	The handset may be out of range. Move it closer to the telephone base.
	If you subscribe to high-speed Internet service (DSL - digital subscriber line) through your telephone line, you must install a DSL filter between the telephone line cord and the telephone wall jack. The filter prevents noise and caller ID problems caused by DSL interference. Contact your DSL service provider for more information about DSL filters.
	Appliances or other cordless telephones plugged into the same circuit as the telephone base can cause interference. Try moving the appliance or telephone base to another outlet. The location of your telephone base can impact the performance of your cordless phone. For better reception, install the telephone base in a centralized location within your home or office, away from walls or other obstructions. In many environments, elevating the telephone base improves overall performance.

The telephone does not receive caller ID or the telephone does not show caller ID during call waiting.	Caller ID is a subscription service. You must subscribe to this service from your telephone service provider for this feature to work on your telephone.
	Both your and the caller's telephone service providers must use equipment compatible with the caller ID service.
	The caller may not be calling from an area which supports caller ID. The caller ID information displays after the first or second ring.
The display shows <b>Out of range or no pwr at base</b> .	The handset may be out of range. Move it closer to the telephone base.
	Make sure the power cord is securely plugged into the telephone base. Use a working electrical outlet not controlled by a wall switch.
I cannot hear any instruction from the handset when I try to record, play or delete my own announcement.	The handset does not have a speakerphone. When recording, playing or deleting your own announcement, the instructions are announced through the handset receiver. Make sure you place the handset receiver close to your ear.
The outgoing announcement is not clear.	When recording the announcement, make sure you speak in a normal tone of voice towards the microphone of the handset.
	Make sure there is no background noise when recording.

The answering system does not record messages.	Make sure the answering system is on. When the answering system is on, <b>ANS ON</b> should display on the handset and the telephone base.
	When the answering machine memory is full, it does not record new messages until some old messages are deleted.
	If you subscribe to voicemail service, change the number of rings so that your answering system answers before your voicemail service answers. To determine how many rings activate your voicemail service, contact your telephone service provider.
The messages on the answering system are very difficult to hear.	Press <b>▲/VOLUME</b> on the handset or <b>VOL +</b> on the telephone base to increase the listening volume.
The answering system does not announce the correct day of the week for recorded messages time stamp.	Make sure you have set the date and time. See <b>Set date and time</b> section.
The messages on the answering system are incomplete.	The maximum length for a message is four minutes. If a caller leaves a very long message, i.e., more than four minutes, part of it may be lost when the answering system disconnects the call.
	If the memory on the answering system becomes full during a message, the answering system stops recording and disconnects the call.
	If the caller's voice is very soft, the answering system may stop recording and disconnect the call.

The answering system does not respond to remote commands.	Make sure you enter the correct remote access code.
	Make sure you are calling from a touch-tone telephone. When dialing a number, there should be tones. If there are clicks, then it is not a touch-tone telephone and cannot activate the answering system.
	The answering system may not detect the remote access code when your announcement is playing. Wait until the announcement is over before entering the code.
I subscribe to a nontraditional telephone service that uses my computer to establish connections, and my telephone doesn't work.	Make sure your computer is powered on, and your Internet is working properly.
	Make sure to plug your USB telephone adapter into a dedicated USB port on your computer. Do not plug into a multiple port USB hub (USB splitter) that is not powered.
	In a few rare instances, the USB port on your computer may not have enough power. In these instances, try using a USB hub with its own external power supply.
I accidentally set my LCD language to Spanish or French, and I don't know how to change it back to English.	If you are using a firewall, it may prevent access to your nontraditional telephone service. Contact your service provider for more information.
	While the handset is not in use, press <b>MENU/SELECT</b> and then enter <b>*364#</b> to change the handset LCD language back to English.

# Limited Warranty

## What does this limited warranty cover?

The manufacturer of this VTech Product warrants to the holder of a valid proof of purchase ("Consumer" or "you") that the Product and all accessories provided in the sales package ("Product") are free from defects in material and workmanship, pursuant to the following terms and conditions, when installed and used normally and in accordance with the Product operating instructions. This limited warranty extends only to the Consumer for Products purchased and used in the United States of America and Canada.

## What will VTech do if the Product is not free from defects in materials and workmanship during the limited warranty period ("Materially Defective Product")?

During the limited warranty period, VTech's authorized service representative will replace at VTech's option, without charge, a Materially Defective Product. If we replace the Product, we may use new or refurbished replacement parts. If we choose to replace the Product, we may replace it with a new or refurbished Product of the same or similar design. We will retain defective parts, modules, or equipment. Replacement of the Product, at VTech's option, is your exclusive remedy. VTech will return the replacement Products to you in working condition. You should expect the replacement to take approximately 30 days.

## How long is the limited warranty period?

The limited warranty period for the Product extends for ONE (1) YEAR from the date of purchase. If VTech replaces a Materially Defective Product under the terms of this limited warranty, this limited warranty also applies to the replacement Product for a period of either (a) 90 days from the date the replacement Product is shipped to you or (b) the time remaining on the original one-year warranty; whichever is longer.

## What is not covered by this limited warranty?

This limited warranty does not cover:

1. Product that has been subjected to misuse, accident, shipping or other physical damage, improper installation, abnormal operation or

handling, neglect, inundation, fire, water or other liquid intrusion.

2. Product that has been subjected to contact with liquid, water, rain, extreme humidity or heavy perspiration, sand, dirt or the like; but then only to the extent the damage was not caused by incorrectly securing the waterproof handset's protective elements, for example, failing to properly close a seal), or such protective elements are damaged or missing (e.g. a cracked battery door), or subjecting a Product to conditions beyond its stated specifications or limits (e.g. 30 minutes in 1 meter of fresh water).
3. Product that has been damaged due to repair, alteration or modification by anyone other than an authorized service representative of VTech;
4. Product to the extent that the problem experienced is caused by signal conditions, network reliability, or cable or antenna systems;
5. Product to the extent that the problem is caused by use with non-VTech accessories;
6. Product whose warranty/quality stickers, product serial number plates or electronic serial numbers have been removed, altered or rendered illegible;
7. Product purchased, used, serviced, or shipped for repair from outside the United States of America or Canada, or used for commercial or institutional purposes (including but not limited to Products used for rental purposes);
8. Product returned without a valid proof of purchase (see item 2 below); or
9. Charges for installation or set up, adjustment of customer controls, and installation or repair of systems outside the unit.

## How do you get warranty service?

To obtain warranty service in the USA, please visit our website at [www.vtechphones.com](http://www.vtechphones.com) or call 1 (800) 595-9511.

To obtain warranty service in Canada, go to [phones.vtechcanada.com](http://phones.vtechcanada.com) or dial 1 (800) 267-7377.

**NOTE:** Before calling for service, please review the user's manual - a check of the Product's controls and features may save you a service call.

Except as provided by applicable law, you assume the risk of loss or damage during transit and transportation

and are responsible for delivery or handling charges incurred in the transport of the Product(s) to the service location. VTech will return replaced Product under this limited warranty. Transportation, delivery or handling charges are prepaid.

VTech assumes no risk for damage or loss of the Product in transit. If the Product failure is not covered by this limited warranty, or proof of purchase does not meet the terms of this limited warranty, VTech will notify you and will request that you authorize the cost of replacement prior to any further replacement activity. You must pay for the cost of replacement and return shipping costs for the replacement of Products that are not covered by this limited warranty.

## What must you return with the Product to get warranty service?

1. Return the entire original package and contents including the Product to the VTech service location along with a description of the malfunction or difficulty; and
2. Include a "valid proof of purchase" (sales receipt) identifying the Product purchased (Product model) and the date of purchase or receipt; and
3. Provide your name, complete and correct mailing address, and telephone number.

## Other limitations

This warranty is the complete and exclusive agreement between you and VTech. It supersedes all other written or oral communications related to this Product. VTech provides no other warranties for this Product. The warranty exclusively describes all of VTech's responsibilities regarding the Product. There are no other express warranties. No one is authorized to make modifications to this limited warranty and you should not rely on any such modification.

State/Provincial Law Rights: This warranty gives you specific legal rights, and you may also have other rights, which vary from state to state or province to province.

Limitations: Implied warranties, including those of fitness for a particular purpose and merchantability (an

unwritten warranty that the Product is fit for ordinary use) are limited to one year from the date of purchase. Some states/provinces do not allow limitations on how long an implied warranty lasts, so the above limitation may not apply to you. In no event shall VTech be liable for any indirect, special, incidental, consequential, or similar damages (including, but not limited to lost profits or revenue, inability to use the Product or other associated equipment, the cost of substitute equipment, and claims by third parties) resulting from the use of this Product. Some states/provinces do not allow the exclusion or limitation of incidental or consequential damages, so the above limitation or exclusion may not apply to you.

## Please retain your original sales receipt as proof of purchase

## Disclaimer and Limitation of Liability

VTech Communications, Inc. and its suppliers assume no responsibility for any damage or loss resulting from the use of this user's manual. VTech Communications, Inc. and its suppliers assume no responsibility for any loss or claims by third parties that may arise through the use of this product.

**Company:** VTech Communications, Inc.

**Address:** 9020 SW Washington Square Road - Ste 555 Tigard, OR 97223, United States

**Phone:** 1 (800) 595-9511 in the U.S. or 1 (800) 267-7377 in Canada

Go to [www.vtechphones.com](http://www.vtechphones.com) **(US)** to register your product for enhanced warranty support and the latest VTech product news.

Go to [phones.vtechcanada.com](http://phones.vtechcanada.com) **(Canada)** for the latest VTech product news.



Specifications are subject to change without notice.

© 2022 VTech Communications, Inc.

All rights reserved. v1.0. 01/22