

## **1. About Your L60 SES (T2277)**

1.1 What's in the box

1.2 Overview

1.3 Buttons Control

1.4 LED Indication

## **2. Preparing Your L60 SES (T2277)**

2.1 Important Tips Before Use

2.2 Preparation

2.3 Power On / Off

## **3. Using Your RoboVac with the eufy Clean App**

3.1 Download the App

3.2 Reset the Wi-Fi Connection

3.3 Quick Mapping and Floor Plan

3.4 Set Up No-Go Zone and Virtual Wall (Available on the App Only)

3.5 Select a Cleaning Mode

3.6 Select a Suction Power Level

3.7 Use RoboVac with Amazon Alexa / The Google Assistant

## **4. Cleaning and Maintenance**

4.1 Clean the Dust Box and Filter

4.2 Clean the Rolling Brush

4.3 Clean the Side Brush

4.4 Clean the Sensors and Charging Pins

4.5 Clean the Hair Collection Box

## **5. Troubleshooting**

## **6. Specifications**

# 1. About Your L60 SES (T2277)

## 1.1 What's in the box

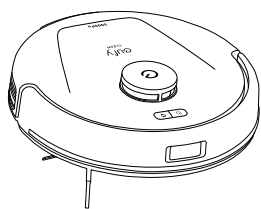

Main Unit

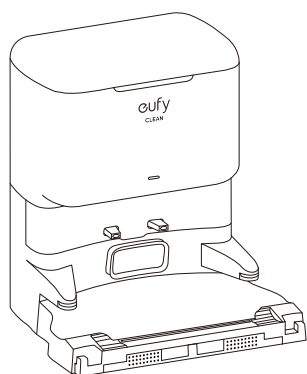

Self Empty Station and  
Power Cord

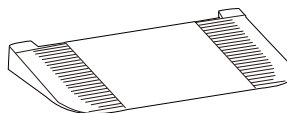

Documents



Detachable Base

## 1.2 Overview

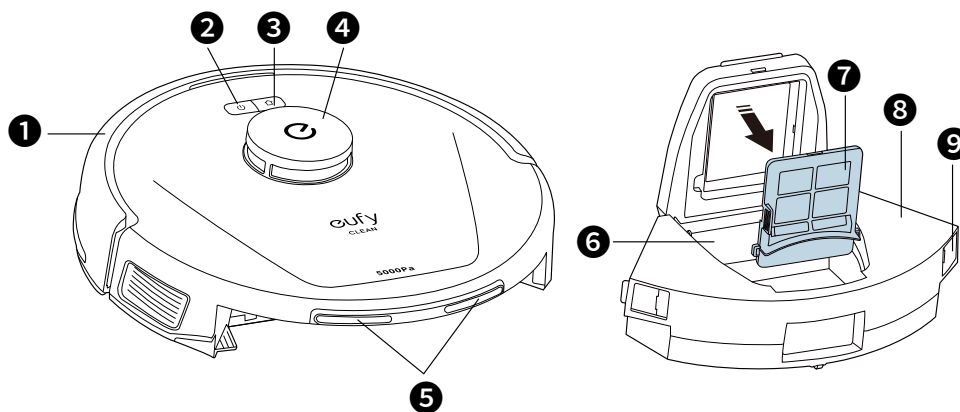

- ❶ Bumper
- ❷ Cleaning Start / Pause button
- ❸ Recharge Button
- ❹ 360° Lidar Navigation Sensor
- ❺ Charging Pins
- ❻ Back Flow Prevention Flap
- ❼ Filter
- ❽ Dust Box
- ❾ Dust Box Release Buttons (×2)

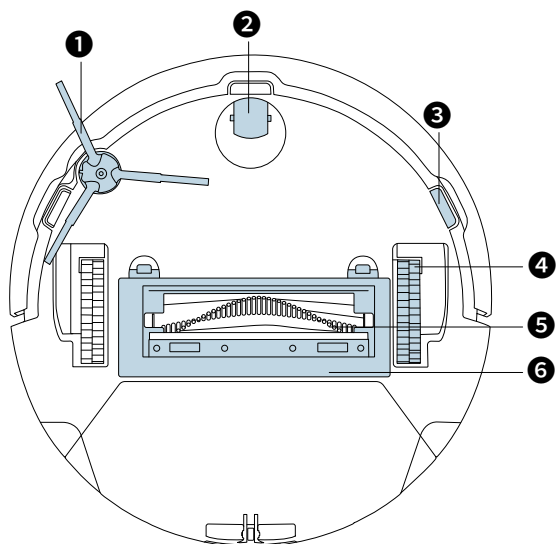

- ❶ Side Brush
- ❷ Swivel Wheel
- ❸ Anti-drop Sensors (×3)
- ❹ Wheels (×2)
- ❺ Rolling Brush
- ❻ Brush Guard

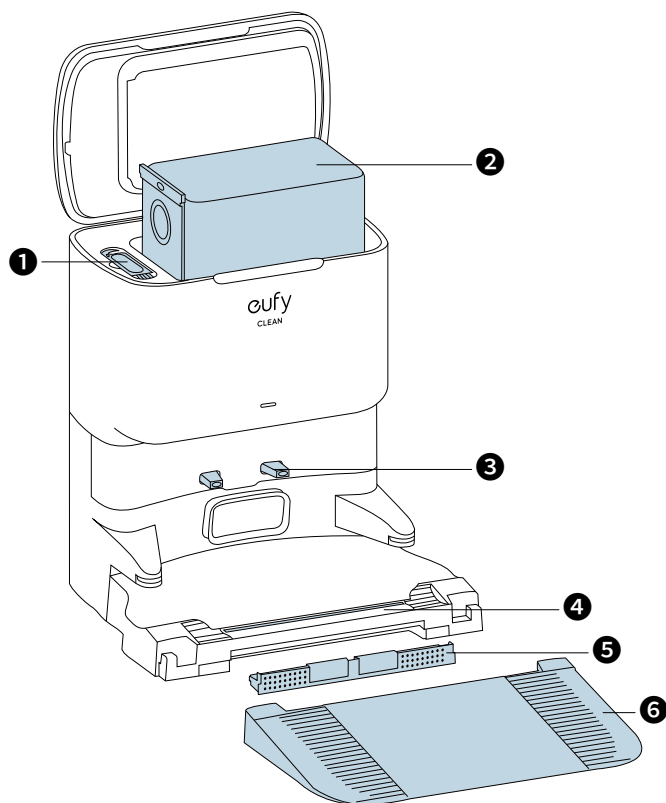

- ❶ Cleaning Tool
- ❷ Disposable Dust Bag
- ❸ Charging Pins
- ❹ Automatic Hair Detangling Slot\*
- ❺ Hair Collection Box
- ❻ Detachable Base

### \*How Hair Detangling Works

The Self Empty Station is equipped with an electric rolling blade, which automatically starts detangling hair on the rolling brush once RoboVac has returned to the station.

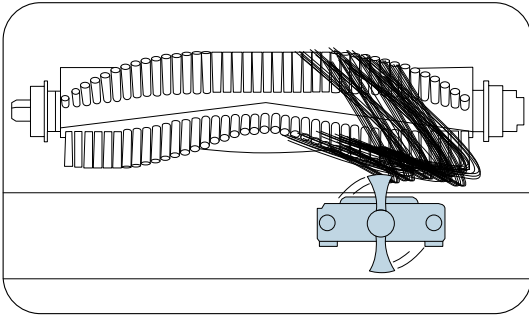

Every time RoboVac returns to the Self Empty Station, the hair cutting blade will be triggered to extend and start detangling the hair on the rolling brush. During the hair cutting process, if a child or pet accidentally lifts up RoboVac by more than 0.11 inch/ 3mm, the blade will stop working immediately and retract into the base to prevent accidental injury.







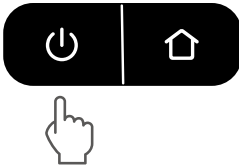
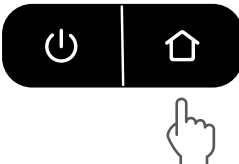
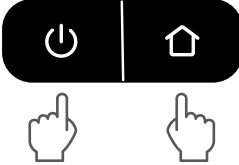

If there is a sudden power outage at your home, the Self Empty Station will detect the power failure and automatically retract the cutting blade into the station.

- 💡 • If RoboVac returns to the Self Empty Station with a low battery, the Station will hold off the hair detangling process until RoboVac is fully charged. Once RoboVac is fully powered, the Self Empty Station will perform the hair detangling task before RoboVac proceeds to a new cleaning task.

### 1.3 Buttons Control





	<ul style="list-style-type: none"><li>• Long press (3s): Power on or off</li><li>• Short press: Pause / finish the current task when working</li></ul>
	<ul style="list-style-type: none"><li>• Short press: Return RoboVac to the Self Empty Station</li><li>• Short press: Pause the current task when working</li><li>• Long press (3s): Enable or disable Child Safety Lock</li></ul>
	<ul style="list-style-type: none"><li>• Long press simultaneously (3s): Reset the Wi-Fi connection</li></ul>

## 1.4 LED Indication

Button	LED Indication	RoboVac Status
	<ul style="list-style-type: none"> <li>• Solid white</li> </ul>	<ul style="list-style-type: none"> <li>• Working normally</li> </ul>
	<ul style="list-style-type: none"> <li>• Pulsing white (When attached to Self Empty Station)</li> </ul>	<ul style="list-style-type: none"> <li>• Charging, battery level &gt; 12% (When fully charged for 1 minute, RoboVac switches to Sleep Mode)</li> </ul>
	<ul style="list-style-type: none"> <li>• Flashing white</li> </ul>	<ul style="list-style-type: none"> <li>• Returning to Self Empty Station</li> </ul>
	<ul style="list-style-type: none"> <li>• Flashing red slowly</li> </ul>	<ul style="list-style-type: none"> <li>• Error</li> <li>* Refer to the "Troubleshooting" section in this manual, check in-app instructions, or contact eufy Customer Service for solutions</li> <li>• In Standby mode and battery level &lt; 12%</li> </ul>
	<ul style="list-style-type: none"> <li>• Flashing white quickly</li> </ul>	<ul style="list-style-type: none"> <li>• Wi-Fi connection is being reset</li> </ul>
	<ul style="list-style-type: none"> <li>• Solid red</li> </ul>	<ul style="list-style-type: none"> <li>• RoboVac's Wi-Fi connection has dropped</li> </ul>
	<ul style="list-style-type: none"> <li>• Off</li> </ul>	<ul style="list-style-type: none"> <li>• RoboVac switches to Sleep Mode after being idle for 10 minutes</li> </ul>

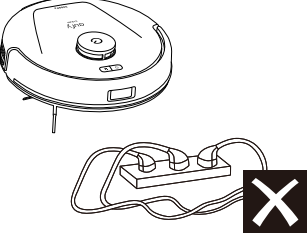
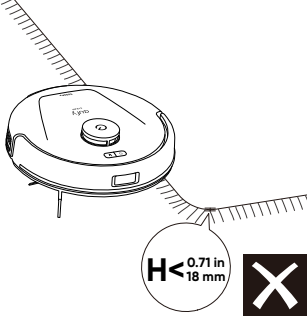
## 2. Preparing Your L60 SES (T2277)

### 2.1 Important Tips Before Use

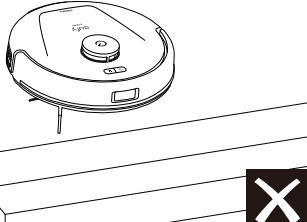
<b>A</b> 	<b>A.</b> Remove power cords and small objects from the floor that may entangle RoboVac.
<b>B</b> 	<b>B.</b> Fold tasseled edges of rugs underneath to prevent tangling RoboVac. Avoid cleaning high-pile rugs or rugs thicker than 0.71 in / 18 mm as they may cause RoboVac to malfunction.
<b>C</b> 	<b>C.</b> It is strongly recommended to place physical barriers or set a "No-Go" zone via the eufy Clean app in front of fireplaces, the edge of staircase, and certain areas (i.e. air vents) that may cause damage to RoboVac if entered.
<b>D</b> 	<b>D.</b> Avoid vacuuming large amounts of water as it may damage the device.
<b>E</b> 	<b>E.</b> RoboVac may climb on top of objects less than 0.79 in / 20 mm in height. Remove these objects if possible.
<b>F</b> 	<b>F.</b> Anti-drop sensors will prevent RoboVac from tumbling down stairs and steep drops in most cases. Sensors are less effective if dirty or used on carpeted / reflective floors. Place physical barriers or set a "No-Go" zone to block off areas where RoboVac may fall.

## 2.2 Preparation

1. Remove the foam blocks beside the bumper and all the protective films before use.

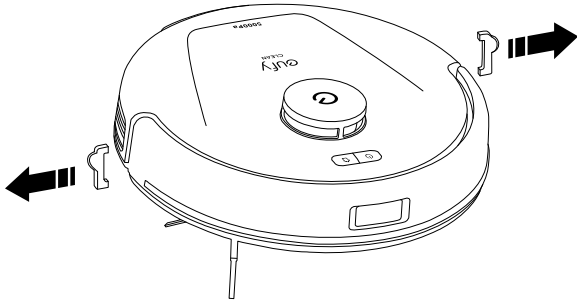

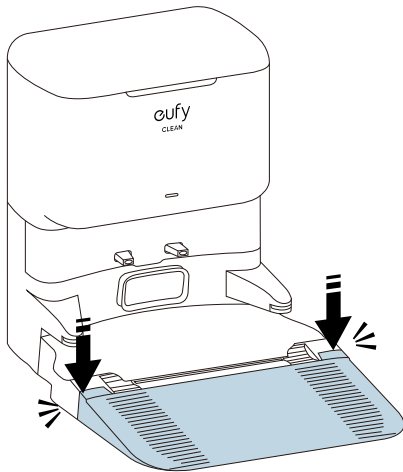

2. Install the detachable base by pressing down both sides of it firmly until you hear a click.

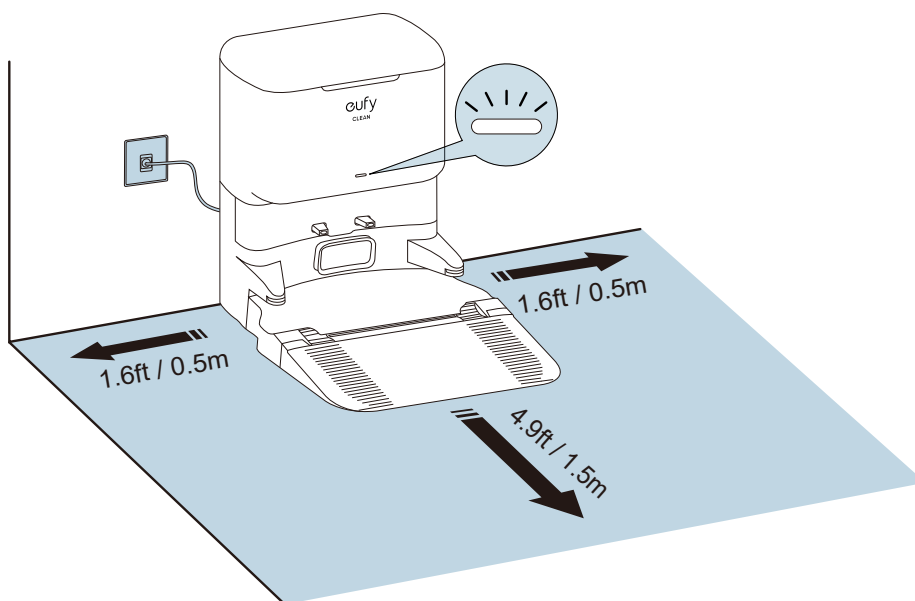

 • Make sure the detachable base is seamlessly connected to the Self Empty Station, otherwise RoboVac will fail to return to the Self Empty Station smoothly.

3. Install the Self Empty Station in a location that RoboVac can easily access. It is recommended to place it against a wall and on a hard, level surface rather than on rugs or carpets. Then connect the power cord to the Self Empty Station and a wall outlet.



 • At all times, please do not touch the automatic hair detangling slot with your hands.  
• Always keep the Self Empty Station plugged in, otherwise RoboVac will not automatically return to it.

4. Attach RoboVac to the Self Empty Station by aligning their charging pins.

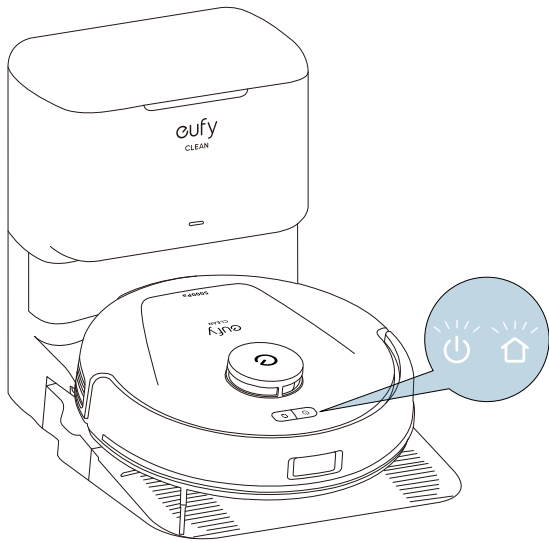

### Auto Recharge and Resume

RoboVac returns to the Self Empty Station automatically to recharge when:

- RoboVac has finished cleaning;
- Cleaning is not complete and the battery level becomes low; once recharged to 80% battery capacity, RoboVac will resume and finish the remaining cleaning.

-  Do not move the Self Empty Station during cleaning, otherwise RoboVac may fail to return for recharge. If failed, you have to manually attach it to the Self Empty Station. If the Self Empty Station is moved, start cleaning from the new location. RoboVac will automatically return when it has finished cleaning.
- Whenever RoboVac returns to the Self Empty Station, the Station will automatically start detangling the hair on the rolling brush. During this process, do not move the Self Empty Station or touch the hair detangling slot.

### 2.3 Power On / Off

Press and hold the power and recharge buttons for 3 seconds to power on or off.

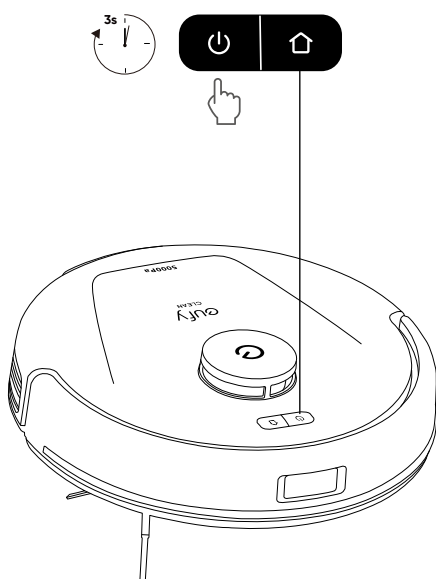

-  After powering on RoboVac, please wait for 20 seconds after the startup music sounds before proceeding to the next operation.

### 3. Using Your RoboVac with the eufy Clean App

To enjoy all the available features, it is recommended to control your RoboVac via the eufy Clean app.

#### Before you start, make sure:

- Your smartphone or tablet is running iOS 11 (or above) or Android 8.0 (or above).
- The 2.4GHz band or 5.0GHz band wireless signal is enabled on your wireless router.

#### 3.1 Download the App

1. Download the eufy Clean app from the App Store (iOS devices) or Google Play (Android devices), or by clicking the link: <https://dl-eufy.eufylife.com/qcdl/index.html?flow=eufy>
2. Open the app and create a user account.
3. Tap the "+" icon to add RoboVac to your eufy Clean account.
4. Follow the instructions in the app to set up the Wi-Fi connection.
  - After connecting successfully, you can control RoboVac via the app.
  - With the app, you can select cleaning modes, select cleaning at your desired suction power, schedule cleaning, view the system status, set up "No-Go" zones, receive notifications, and access additional features.

 • If RoboVac gets stuck in any space, tap **Find My Robot** in the app to find the device.

#### 3.2 Reset the Wi-Fi Connection

If you bump into issues when connecting your RoboVac to the eufy Clean app, you can try to reset the Wi-Fi connection. To reset the Wi-Fi connection, press and hold the two buttons simultaneously for 3 seconds until you hear a voice prompt.

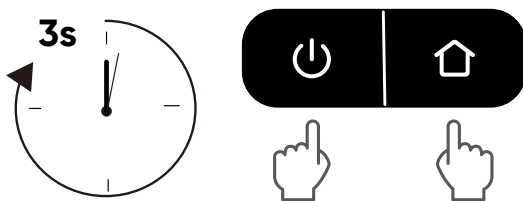

You will hear a voice prompt when the Wi-Fi connection has been reset, and the LED indicators on RoboVac will quickly flash red. Now you can follow the Wi-Fi instructions in the app to set up the Wi-Fi connection.

#### 3.3 Quick Mapping and Floor Plan

 • For a deep dive into how to use the Mapping feature, click the link below to explore more!  
(<https://support.eufy.com/s/product/a085g00000GiufvAAB/eufy-clean-l60-ses>)

Quick mapping helps RoboVac to learn the correct learning path and the environment of your home easily. A floor plan will be built after cleaning.

To create a complete floor plan:

1. Open your doors so that RoboVac can map each room. You can also block off certain areas that you don't want RoboVac to enter, which can improve the success rate of Quick Mapping.
2. Remove any objects that may be in the way or that might entangle RoboVac.

 • Do not remove the Self Empty Station after a floor plan is created.

#### 3.4 Set Up No-Go Zone and Virtual Wall (Available on the App Only)

With the eufy Clean app, you can set up a "No-Go Zone" or "Virtual Wall" as a restricted area. This eliminates the need to use physical barriers, including boundary strips. This feature is only designed for dividing the cleaning zones, not for isolating hazardous areas.

- No-Go Zone: RoboVac will not enter the zone to vacuum.
- Virtual Wall: RoboVac will not cross the virtual wall.

 • To set a virtual wall, RoboVac must initially perform a cleaning run to create a floor plan.

- Although a virtual wall is set, RoboVac may still enter the restricted zone due to repositioning failure or abnormal sensors.
- Moving the device or changing the environment may lose the virtual wall and cause the mapping to fail and rebuild.



### 3.7 Use RoboVac with Amazon Alexa / The Google Assistant

Amazon Alexa or the Google Assistant are smart voice control devices that enable you to control RoboVac with your voice.

**Before you start, make sure:**

- RoboVac is attached to the Self Empty Station to ensure there is enough power.
- RoboVac is connected with the eufy Clean app.
- You have an Amazon Alexa-enabled device (i.e. Amazon Echo, Echo Dot, Amazon Tap, Echo Show, or Echo Spot) or a device enabled with the Google Assistant (i.e. Google Home, Google Home Mini). These devices are sold separately.
- The Amazon Alexa app or Google Home app is already installed on your smart device, and you have created an account.

**To control RoboVac with Amazon Alexa or the Google Assistant:**

1. Open the eufy Clean app and find "Smart Integrations" in the top left.
2. Follow the on-screen instructions to complete the setup.

## 4. Cleaning and Maintenance

Prior to cleaning and maintaining, power off the device and unplug the power adapter. Any other servicing should be performed by an authorized service representative.

For optimal performance, follow the instructions below to clean and maintain RoboVac regularly. The cleaning and replacement frequency will depend on your RoboVac usage habits.

**Recommended Cleaning and Replacement Frequency**



Click the link below to shop for accessories:

[https://us.eufy.com/collections/ap-accessory?ref=navimenu\\_1\\_7\\_copy&Product%20Name=L60%20SES](https://us.eufy.com/collections/ap-accessory?ref=navimenu_1_7_copy&Product%20Name=L60%20SES)

RoboVac Part	Cleaning Frequency	Replacement Frequency
Dust Box	After each use	-
Filter	Once a week	Every 3 months
Side Brush	Once a month	Every 3-6 months (or when visibly worn)
Brush Guard	Once a month	Every 3-6 months (or when visibly worn)
Rolling Brush	Once a week	Every 6-12 months
Sensors	Once a month	-
Charging Pins	Once a month	-
Swivel Wheel	Once a month	-
Hair Collection Box	Once a month	-

## 4.1 Clean the Dust Box and Filter

- ① Press the release buttons on both sides to detach the dust box from RoboVac.
- ② Open the lid of the dust box.
- ③ Empty the dust box.
- ④ Take out the filter.
- ⑤ Dust off the remains on the filter.
- ⑥ Clean the filter with water.
- ⑦ Air dry the filter before next use.
- ⑧ Place the filter back to the dust box.
- ⑨ Close the dust box.
- ⑩ Reinstall the dust box onto RoboVac.

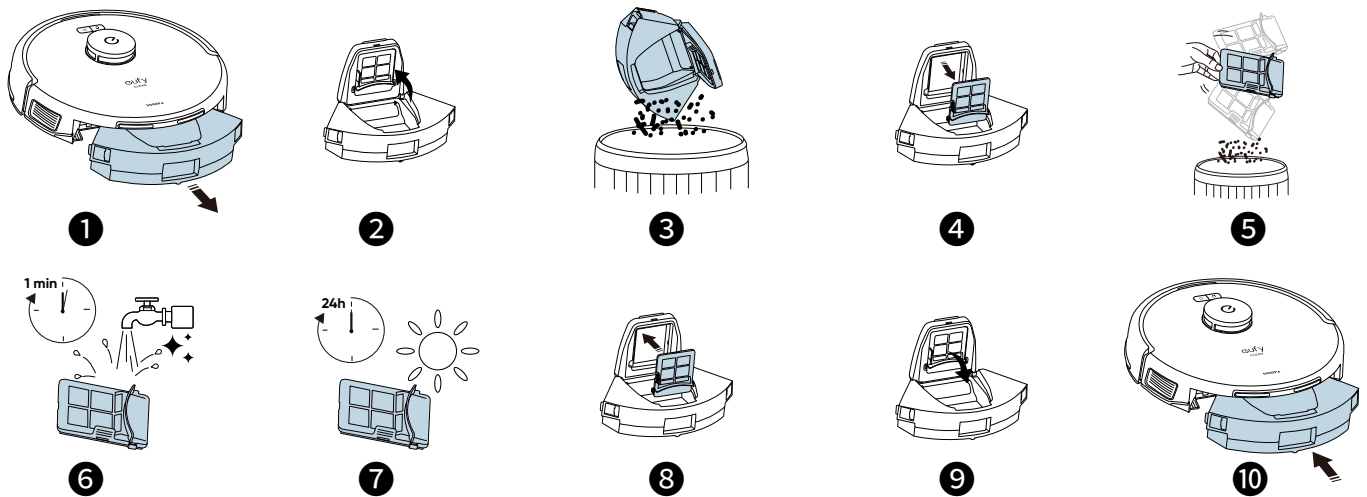

- ⚠ • When reinstalling the dust box, make sure you hear two clicks on both sides to confirm the dust box has been fixed in place.
- Do not remove the backflow prevention flap to ensure that debris does not spill out of the dust box during the cleaning process or when pulling out the dust box.

## 4.2 Clean the Rolling Brush

- ① Turn over the main unit, push the release tabs with both hands to unlock the brush guard.
- ② Take out the rolling brush. Clean the hair entangled on the rolling brush and debris with a scissor or cleaning tool.
- ③ Wash the rolling brush and brush guard with water.
- ④ Air dry the the rolling brush and brush guard before next use.
- ⑤ Reinstall the rolling brush by inserting the fixed protruding end first.
- ⑥ Push back the brush guard until you hear a click.

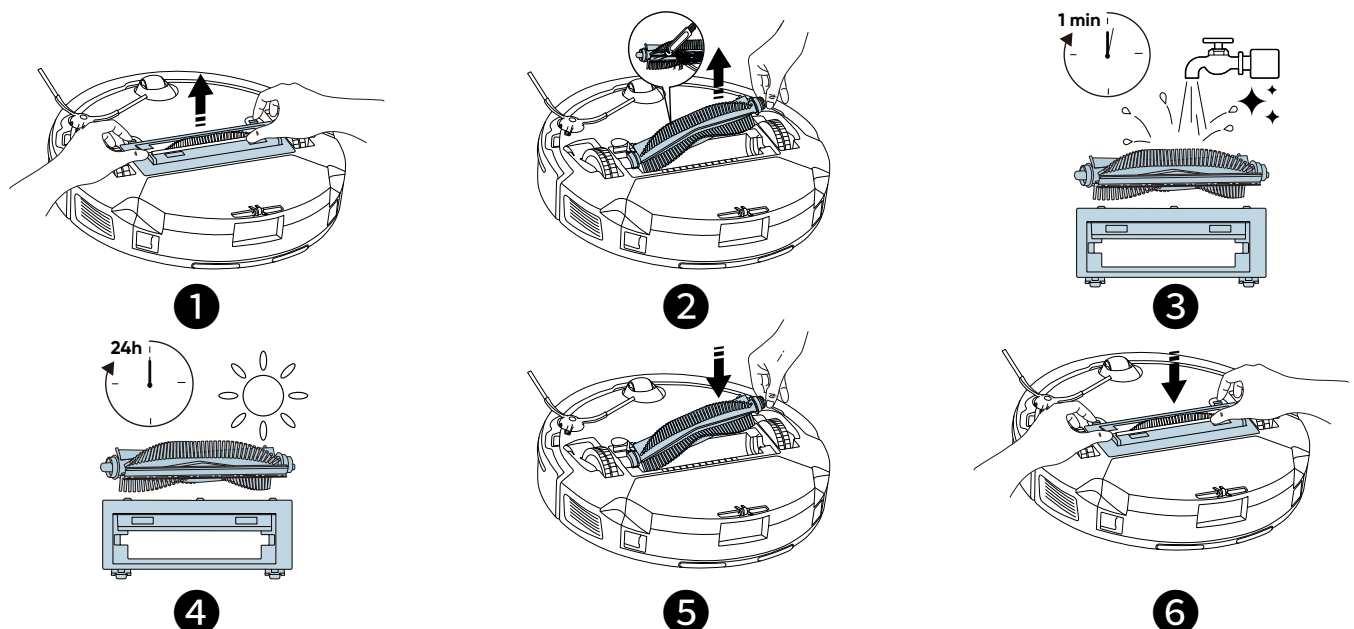

### 4.3 Clean the Side Brush

Foreign substances, such as hair, can easily get tangled in the side brush, so it is best to clean it regularly.

- ① Remove the side brush with a screwdriver.
- ② Carefully unwind and pull off any hair or substances that are wrapped between the main unit and the side brush.
- ③ Clean the side brush with water.
- ④ Air dry the side brush before next use.
- ⑤ Reinstall the side brush on the machine.

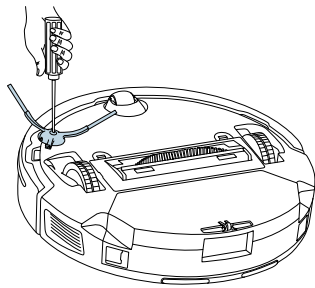

①

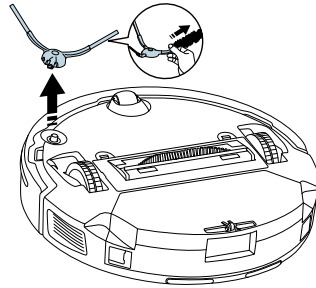

②

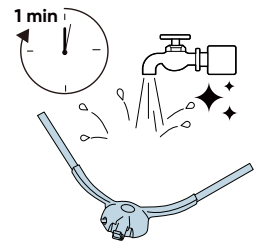

③

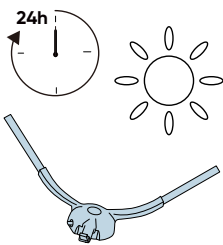

④

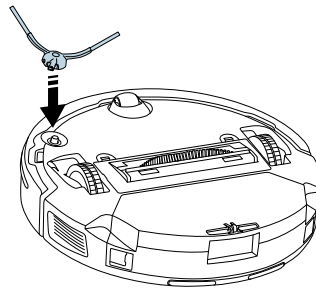

⑤

### 4.4 Clean the Sensors and Charging Pins

To maintain the best performance, clean the sensors and charging pins regularly.

- Dust off the sensors and charging pins using a cloth or cleaning brush.

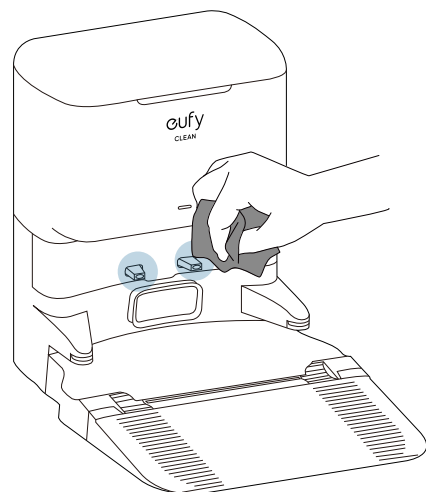
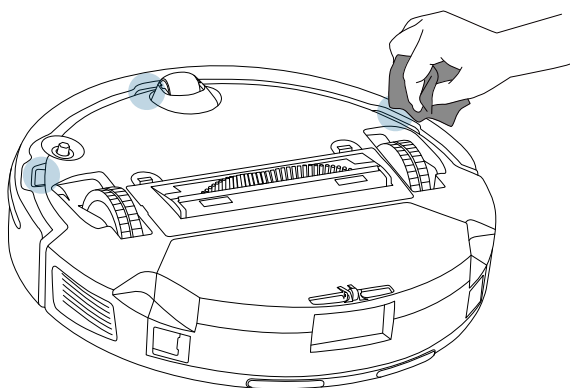

## 4.5 Clean the Hair Collection Box

- ① Remove the detachable base.
- ② Take out the hair collection box from the Self Empty Station.
- ③ Empty the hair collection box.
- ④ Wash the hair collection box with water.
- ⑤ Air dry the hair collection box before next use.
- ⑥ Reinstall the hair collection box back to the Self Empty Station.
- ⑦ Reinstall the detachable base.

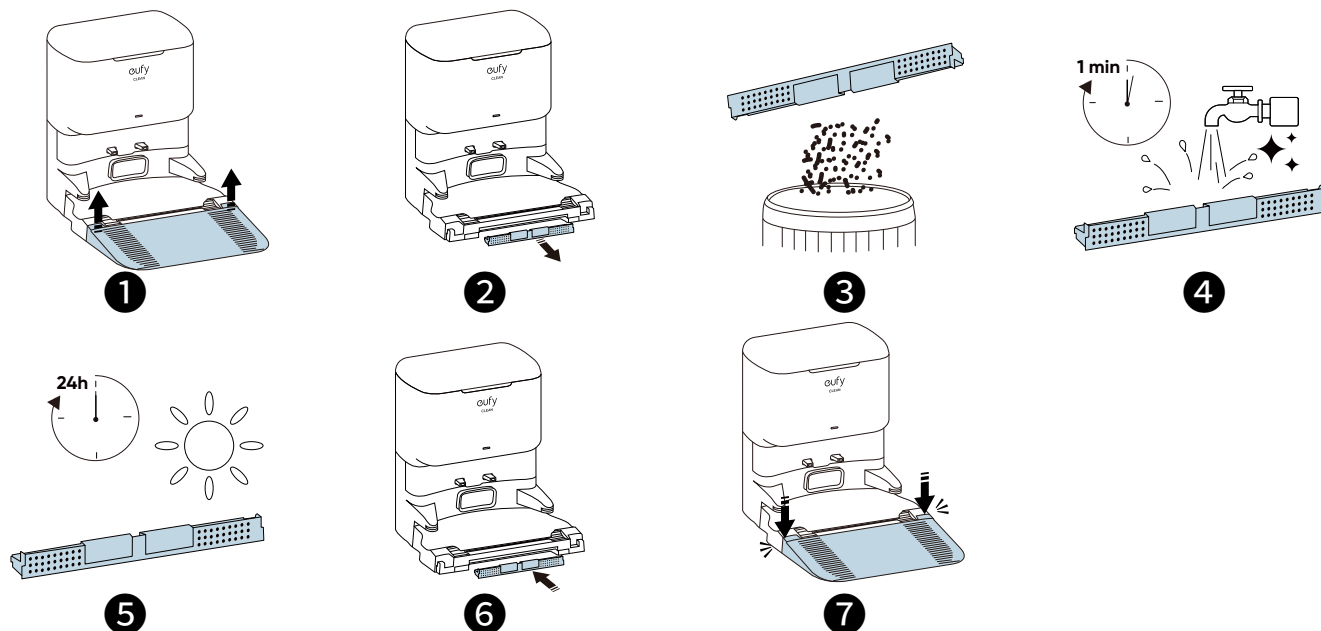

## 5. Troubleshooting

Here are just a few preliminary suggestions. If your problem persists or if you need further troubleshooting information, please visit <https://support.eufylife.com>, go to the eufy Clean app, or contact [support@eufy.com](mailto:support@eufy.com) for help.

Problems	Solutions
RoboVac will not turn on.	<ul style="list-style-type: none"> <li>• Press and hold on RoboVac for 3 seconds to turn it on. Make sure the battery is fully charged.</li> <li>• Make sure the battery is fully charged.</li> <li>• If it still has no response, turn RoboVac off and then turn it back on.</li> </ul>
RoboVac suddenly stops working.	<ul style="list-style-type: none"> <li>• Check if RoboVac is trapped or stuck on an obstacle.</li> <li>• Check if the battery level is too low.</li> <li>• If your problem persists, turn RoboVac off, wait for 5 seconds, and then turn it back on.</li> <li>• Check if RoboVac has alerted you with any voice prompts or LED indicators.</li> <li>• Open the eufy Clean app to check the specific error prompt, then refer to the Troubleshooting section of the manual for solutions.</li> </ul>
You cannot schedule cleanings.	<ul style="list-style-type: none"> <li>• Make sure the scheduled time has been set correctly. Check if the time zone in the eufy Clean app is consistent with that on your mobile device.</li> <li>• Make sure RoboVac is turned on and the battery is fully charged. Cleaning schedules are erased when RoboVac is powered off. If RoboVac is turned on without Internet access, cleaning schedules will not synchronize and must be reset via the app.</li> </ul>

Problems	Solutions
Suction power is weak.	<ul style="list-style-type: none"> <li>• Check if any obstructions are blocking the suction inlet.</li> <li>• Empty the dust box.</li> <li>• Check if the filter is wet due to water or other liquid on the floor. Air-dry the filter completely before use.</li> <li>• Check if the brush guard is correctly installed.</li> <li>• Check the suction power level previously selected in the eufy Clean app. Adjust the setting if necessary.</li> </ul>
RoboVac cannot be charged.	<ul style="list-style-type: none"> <li>• Make sure the Self Empty Station is powered on.</li> <li>• Dust off the charging pins with a dry cloth.</li> <li>• Check if there is any physical damage on RoboVac or the charging pins of Self Empty Station</li> <li>• Check if you can hear the "Charging" voice prompt when RoboVac is attached to the Self Empty Station</li> </ul>
RoboVac cannot return to the Self Empty Station	<ul style="list-style-type: none"> <li>• Remove objects within 1.6 ft / 0.5 m to the left and right sides and within 4.9 ft / 1.5 m of the front of the Self Empty Station.</li> <li>• Make sure the Self Empty Station is powered on.</li> <li>• Make sure the Self Empty Station is not placed on carpets.</li> <li>• Check if RoboVac is stuck on any objects.</li> <li>• Check if the sticker beneath the Self Empty Station has been removed, and the Self Empty Station has been firmly attached to the floor.</li> <li>• Clean the charging pins and sensors carefully with a soft dry cloth.</li> </ul>
RoboVac's movements or travel paths are abnormal.	<ul style="list-style-type: none"> <li>• Clean the sensors carefully with a soft dry cloth.</li> <li>• Restart RoboVac by turning RoboVac off and on.</li> </ul>
RoboVac cannot connect to a Wi-Fi network.	<ul style="list-style-type: none"> <li>• Make sure you entered the Wi-Fi password correctly.</li> <li>• Make sure your RoboVac, router, and phone are close enough to ensure a strong signal strength.</li> <li>• Make sure your Wi-Fi router supports the corresponding frequency band of RoboVac: 2.4/5.0GHz for L60 (T2277)</li> <li>• Reboot RoboVac and your router.</li> <li>• Try connecting RoboVac to a Wi-Fi network with another phone.</li> </ul>
You cannot control RoboVac with Amazon Alexa.	<ul style="list-style-type: none"> <li>• Check if there are any Internet connection problems.</li> <li>• Check whether you have installed the Amazon Alexa app onto your smart device and enabled "eufy Clean - RoboVac" Skill in the Amazon Alexa app. For details, refer to the "Smart Integrations" page in the eufy Clean App.</li> <li>• Make sure you have a eufy Clean account and have connected to RoboVac.</li> <li>• Make sure you are using the correct Alexa voice commands.</li> </ul>
You cannot control RoboVac with the Google Assistant.	<ul style="list-style-type: none"> <li>• Check if there are any Internet connection problems.</li> <li>• Check if you have installed the Google Home app onto your smart device and initiated the "eufy Clean" action in the Google Home app. For details, refer to the "Smart Integrations" page in the eufy Clean App.</li> <li>• Check if you are using the proper commands when talking to the Google Assistant. When making your request, start by saying the wake phrase "Ok Google".</li> <li>• Repeat your question. Speak clearly to the Google Assistant.</li> </ul>

## 6. Specifications

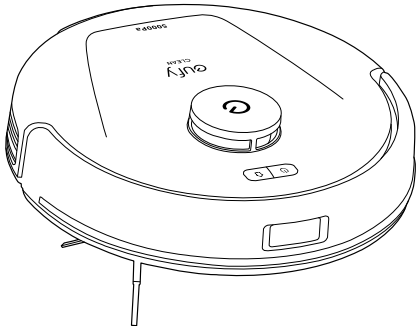
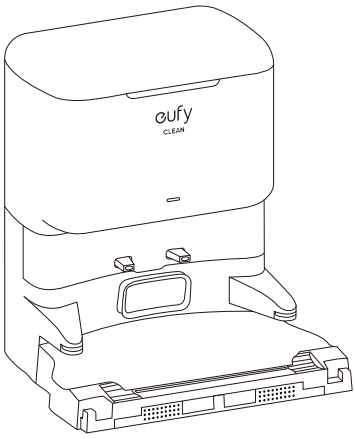
	<b>Input</b>	AC: 100V~240V/0.35A
	<b>Suction Power</b>	5,000Pa
	<b>Wi-Fi Connection</b>	2.4G/5G
	<b>Voice Control</b>	Alexa, Google assistant
	<b>Battery</b>	2600mAh
	<b>Dustbin Capacity</b>	260ml
	<b>Navigation</b>	iPath Laser Navigation
	<b>Climbing Height</b>	20mm
	<b>Product Size</b>	326*102*332mm
	<b>Input</b>	AC: 100V~240V/6A Max
	<b>Output</b>	DC: 20V/0.6A Max
	<b>Station Capacity</b>	2.5L
	<b>Product Size</b>	440*331*356mm