

CR1023

Digital Alarm Clock with USB Charger
THE BEST DECORATION FOR BEDROOM

CE FC RoHS Made in China

Version 1.0

Chapter 1 LOCATION OF CONTROLS

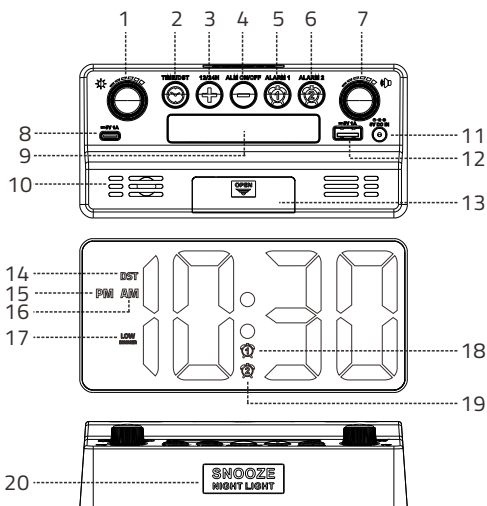

- | | |
|--------------------------------|--------------------------------------|
| 1. DISPLAY DIMMER KNOB | 2. TIME/DST BUTTON |
| 3. 12/24H BUTTON | 4. ALM ON/OFF BUTTON |
| 5. ALARM 1 BUTTON | 6. ALARM 2 BUTTON |
| 7. VOLUME KNOB | 8. TYPE-C CHARGING PORT |
| 9. NIGHT LIGHT | 10. SPEAKER |
| 11. DC IN JACK | 12. USB CHARGING PORT |
| 13. BACKUP BATTERY COMPARTMENT | 14. DST INDICATOR |
| 15. PM INDICATOR | 16. AM INDICATOR |
| 17. LOW DIMMER INDICATOR | 18. ALARM 1 INDICATOR |
| 19. ALARM 2 INDICATOR | 20. TOUCHSCREEN SNOOZE / NIGHT LIGHT |

Chapter 2 POWER SOURCES

1. Install 2pcs 1.5V "AAA" size batteries to the proper terminals in the battery compartment to memorize the time setting and the alarm will ring in case of power outage.
NOTE: Batteries are not included and don't support time display or any other functions
2. Connect the adapter line to DC jack, then plug into a 100~240V AC wall power outlet.

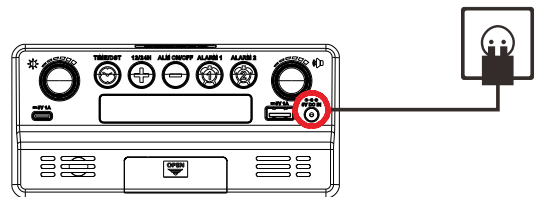









Chapter 3 TIME SETTING

1. Press button once, the **6:30** hour display indicator light starts flickering on the screen.
2. Press or button to set the hour, and press to confirm.
3. After step 2, minute display start flickering, press or button to set the minute.
4. Press button to save time or wait for another 10 seconds to confirm automatically.

12H/24H time format setting

Hold press button to change 12H/24H time format.

Chapter 4 ALARM SETTING

1. Press the  button one time, the  indicator light on and flickering along with hour display  on the screen.
2. Press  or  button to set the hour, and press  to confirm.
3. After step 2, minute display start flickering, press  or  button to set the minute.
4. Press  button to save setting or wait for another 10 seconds to confirm automatically.







ALARM 2 setting same as ALARM 1

Alarm Ring Volume Setting

There is 7 volume levels,  rotate left to turn up, right to turn down. Adjust the volume for your preference.

Turn off Alarm

When alarm goes off:

1. Press  button to temporarily turn off alarm for 9 minutes. Alarm will ring every next 9 minutes.
2. Press  button to turn off alarm for 24 hours. The alarm indicator  or  is still on, which means alarm is still activated and will ring after 24 hours.
3. When alarm is off, press  or  button to active the alarm, setting will be the same as last time

- 03 -

Chapter 5 NIGHT LIGHT

Touch the  button to turn on the night light.

Press the  button again to turn off the night light

Chapter 6 DIMMER

Rotate the DIMMER  button to adjust the display to a comfortable brightness.

There is 7 dimmer levels, rotate left to turn up, right to turn down. Adjust the brightness for your preference.

NOTE : Rotate the button to the end of right, LOW DIMMER indicator display on screen, gone by 20 seconds. Time will be display again when you rotate the button to the left.













Chapter 7 DST

Hold press  button to switch DST function. DST indicator will turn on.

Hold press  button again to turn off DST function. DST indicator will turn off.

- 05 -

Cancel Alarm

1. Hold press  button to turn off alarm 1 and alarm 2 permanently. And corresponding indicator  and  will turn off.
2. Hold press  button, just turn off alarm 1 permanently,  indicator will turn off.
3. Hold press  button, just turn off alarm 2 permanently,  indicator will turn off.
4. If alarm 1 goes off, then hold press  or , just turn off alarm 1 permanently,  indicator will turn off .
5. If alarm 2 goes off, then hold press  or , just turn off alarm 2 permanently,  indicator will turn off.

- 04 -

Chapter 8 USB & TYPE-C CHARGING

Plug charging cable into device such as phone or tablet.

Device can charge both your phone or tablet at the same time.

The maximum charge current is 1 Ampere.

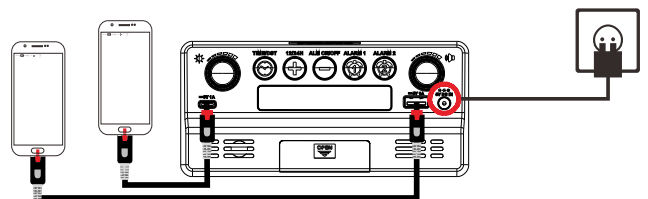

- 06 -