



# **ET-7750 User's Guide**



---

# Contents

<b>ET-7750 User's Guide</b> .....	<b>13</b>
<b>Your Ink Tank System</b> .....	<b>14</b>
<b>Product Basics</b> .....	<b>15</b>
Using the Control Panel .....	15
Control Panel Buttons and Lights .....	16
Using the LCD Screen .....	17
Adjusting Control Panel Position .....	17
Changing LCD Screen Language.....	18
Turning On Quiet Mode .....	18
Product Parts Locations .....	18
Product Parts - Top.....	19
Product Parts - Front .....	20
Product Parts - Inside .....	22
Product Parts - Back.....	23
The Power Off and Sleep Timers .....	23
Changing the Power Off Timer Setting from the Control Panel.....	24
Changing the Sleep Timer Setting from the Control Panel .....	24
Epson Connect Solutions for Smartphones, Tablets, and More .....	25
Setting Up Epson Connect Services.....	26
Using Epson Email Print .....	27
Using the Epson iPrint Mobile App .....	27
Using the Epson Creative Print Mobile App.....	28
Using Epson Remote Print .....	28
Using Epson Scan to Cloud.....	29
Using AirPrint .....	30
Using Google Cloud Print.....	30
Setting Up Google Cloud Print on a Chromebook .....	31
Using the Mopria Print Service .....	32
Android Printing Using the Epson Print Enabler .....	33
Using Fire OS Printing .....	33

Using Windows 10 Mobile Printing .....	34
Using Epson Print and Scan App with Windows Tablets .....	35
<b>Wi-Fi or Wired Networking</b> .....	<b>36</b>
Network Security Recommendations .....	36
Wi-Fi Infrastructure Mode Setup.....	37
Selecting Wireless Network Settings from the Control Panel .....	38
Wi-Fi Direct Mode Setup .....	40
Enabling Wi-Fi Direct Mode .....	40
Changing the Wi-Fi Direct Mode Password .....	42
Wi-Fi Protected Setup (WPS).....	43
Using WPS to Connect to a Network .....	44
Printing a Network Status Sheet.....	44
Changing or Updating Network Connections .....	45
Accessing the Web Config Utility .....	46
Changing a USB Connection to a Wi-Fi Connection.....	46
Changing a Wi-Fi Connection to a Wired Network Connection.....	46
Connecting to a New Wi-Fi Router .....	47
Disabling Wi-Fi Features .....	47
<b>Loading Paper</b> .....	<b>49</b>
Loading Paper in Cassette 1 (Upper Cassette) .....	49
Loading Paper in Cassette 2 (Lower Cassette) .....	54
Loading Paper and Envelopes in the Rear Paper Feed Slot .....	59
Selecting the Paper Settings for Each Source - Control Panel .....	64
Paper or Media Type Settings - Control Panel.....	66
Turning Off the Paper Setting Alert.....	66
Paper Loading Capacity .....	67
Available Epson Papers .....	69
Borderless Paper Type Compatibility .....	71
Paper or Media Type Settings - Printer Software .....	72
<b>Placing Originals on the Product</b> .....	<b>74</b>
Placing Originals on the Scanner Glass .....	74

<b>Copying</b> .....	<b>76</b>
Copying Documents or Photos.....	76
Paper Type Settings - Copying.....	77
Paper Size Settings - Copying.....	78
Copying Options.....	78
Copying and Restoring Photos.....	81
<b>Printing from a Computer</b> .....	<b>83</b>
Printing with Windows.....	83
Selecting Basic Print Settings - Windows.....	83
Paper Source Options - Windows.....	86
Print Quality Options - Windows.....	86
Multi-Page Printing Options - Windows.....	87
Selecting Double-sided Printing Settings - Windows.....	87
Double-sided Printing Options - Windows.....	89
Print Density Adjustments - Windows.....	90
Selecting Additional Layout and Print Options - Windows.....	91
Custom Color Correction Options - Windows.....	93
Image Options and Additional Settings - Windows.....	94
Header/Footer Settings - Windows.....	95
Selecting a Printing Preset - Windows.....	96
Selecting Extended Settings - Windows.....	97
Extended Settings - Windows.....	98
Printing Your Document or Photo - Windows.....	99
Checking Print Status - Windows.....	101
Selecting Default Print Settings - Windows.....	101
Changing the Language of the Printer Software Screens.....	102
Changing Automatic Update Options.....	104
Printing with the Built-in Epson Driver - Windows 10 S.....	105
Selecting Print Settings - Windows 10 S.....	105
Printing on a Mac.....	109
Selecting Basic Print Settings - Mac.....	110
Paper Source Options - Mac.....	114
Print Quality Settings - Mac.....	114

Print Options - Mac .....	115
Selecting Page Setup Settings - Mac .....	115
Selecting Print Layout Options - Mac.....	116
Selecting Double-sided Printing Settings - Mac.....	117
Double-sided Printing Options and Adjustments - Mac.....	118
Managing Color - Mac .....	119
Color Matching and Color Options - Mac .....	120
Selecting Printing Preferences - Mac .....	121
Printing Preferences - Mac.....	122
Printing Your Document or Photo - Mac .....	123
Checking Print Status - Mac.....	123
Cancelling Printing Using a Product Button.....	124
<b>Scanning .....</b>	<b>125</b>
Starting a Scan.....	125
Starting a Scan Using the Product Control Panel .....	125
Scan to Memory Card Options .....	127
Changing Default Scan Job Settings .....	128
Starting a Scan Using the Epson Scan 2 Icon .....	128
Starting a Scan from a Scanning Program.....	131
Scanning from Smart Devices .....	133
Scanning in Epson Scan 2 .....	133
Additional Scanning Settings - Main Settings Tab .....	136
Additional Scanning Settings - Advanced Settings Tab .....	136
Saving Scanned Documents as a Searchable PDF.....	137
<b>Using Memory Cards with Your Product .....</b>	<b>140</b>
Inserting a Memory Card .....	140
Memory Card Types .....	141
Memory Card File Specifications .....	141
Removing a Memory Card.....	142
Printing from a Memory Card .....	142
Viewing and Printing Photos.....	143
Viewing and Printing Photos From the LCD Screen.....	143
Print Setting Options - Memory Card .....	145

Photo Adjustment Options - Memory Card.....	146
Printing Photo Layouts from a Memory Card.....	148
Photo Layout Options .....	150
Printing Photo Greeting Cards.....	151
Creating and Printing a Greeting Card Template .....	151
Printing a Greeting Card from a Template.....	152
Transferring Photos on a Memory Card .....	153
Setting Up File Sharing for Photo Transfers from Your Computer .....	153
Transferring Photos from a Memory Card to Your Computer .....	154
<b>Using an External Device with Your Product .....</b>	<b>156</b>
Printing from a Camera .....	156
Selecting Print and Photo Adjustment Settings .....	156
Print Settings - Camera.....	159
Photo Adjustments - Camera.....	161
Connecting and Printing from a Camera.....	162
Printing from a Camera Wirelessly .....	163
Viewing or Printing from a USB Flash Drive or External Device .....	164
USB Device File Specifications .....	164
Connecting and Using a USB Flash Drive or External Device .....	164
<b>Printing Personalized Projects.....</b>	<b>166</b>
Printing Coloring Book Pages .....	166
Printing Personalized Note Paper .....	167
Printing Lined Paper, Graph Paper, and Music Sheets .....	169
Printing Calendar Pages .....	170
<b>Printing on CDs/DVDs.....</b>	<b>172</b>
CD/DVD Printing Features .....	172
Loading a CD/DVD.....	172
Removing a Printed CD/DVD .....	175
Placing a CD/DVD on the Scanner Glass.....	176
Copying onto a CD/DVD .....	176
Printing Photos from a Memory Card Onto a CD/DVD .....	177
Printing a Jewel Case Insert from a Memory Card .....	179
Printing on CDs/DVDs from a Computer .....	180

Starting Epson Print CD - Windows .....	181
Printing Your CD/DVD Design - Windows .....	182
Starting Epson Print CD - Mac .....	183
Printing Your CD/DVD Design - Mac .....	184
<b>Refilling Ink .....</b>	<b>186</b>
Ink Safety Precautions .....	186
Check Ink Levels .....	187
Checking Ink Levels on Your Product.....	188
Checking Ink Levels with Windows.....	188
Checking Ink Levels - Mac.....	190
Disabling Special Offers with Windows .....	192
Purchase Epson Ink and Maintenance Box.....	193
Ink Bottle and Maintenance Box Part Numbers .....	193
Refilling the Ink Tanks .....	193
Replacing the Maintenance Box.....	199
<b>Adjusting Print Quality .....</b>	<b>203</b>
Print Head Maintenance.....	203
Print Head Nozzle Check.....	203
Checking the Nozzles Using the Product Control Panel .....	204
Checking the Nozzles Using a Computer Utility .....	206
Print Head Cleaning .....	208
Cleaning the Print Head Using the Product Control Panel .....	209
Cleaning the Print Head Using a Computer Utility .....	211
Power Cleaning .....	213
Power Cleaning Using the Product Control Panel.....	213
Power Cleaning Using a Computer Utility .....	214
Print Head Alignment .....	216
Aligning the Print Head Using the Product Control Panel .....	216
Cleaning the Paper Path .....	218
Cleaning the Rear Paper Feed Path Using the Cleaning Sheet .....	219
Cleaning the Printer Head Path.....	220
Checking the Number of Sheets.....	222
Checking the Sheet Counter - Windows .....	222

Checking the Sheet Counter - Mac.....	223
<b>Cleaning and Transporting Your Product .....</b>	<b>225</b>
Cleaning Your Product .....	225
Transporting Your Product .....	225
<b>Solving Problems .....</b>	<b>230</b>
Checking for Software Updates.....	230
Product Status Messages .....	231
Message Appears Prompting You to Reset Ink Levels.....	233
Running a Product Check .....	233
Resetting Control Panel Defaults .....	235
Solving Setup Problems .....	236
Noise After Filling the Ink.....	236
Software Installation Problems .....	236
Control Panel Setup Problems .....	237
Solving Network Problems .....	237
Product Cannot Connect to a Wireless Router or Access Point .....	237
Network Software Cannot Find Product on a Network.....	238
Product Does Not Appear in Mac Printer Window .....	239
Cannot Print Over a Network.....	240
Cannot Scan Over a Network .....	241
Solving Copying Problems .....	242
Product Makes Noise, But Nothing Copies.....	242
Product Makes Noise When It Sits for a While.....	242
Solving Paper Problems.....	243
Paper Feeding Problems.....	243
Paper Jam Problems Inside the Product .....	244
Paper Jam Problems in the Paper Cassette.....	246
Paper Jam Problems in the Rear Cover .....	247
Paper Ejection Problems .....	249
Solving Problems Printing from a Computer.....	249
Nothing Prints .....	250
Product Icon Does Not Appear in Windows Taskbar .....	250
Printing is Slow .....	251

Solving Page Layout and Content Problems .....	252
Inverted Image.....	253
Too Many Copies Print .....	253
Blank Pages Print .....	253
Incorrect Margins on Printout.....	254
Border Appears on Borderless Prints .....	254
Incorrect Characters Print.....	255
Incorrect Image Size or Position .....	255
Slanted Printout .....	256
Solving Print Quality Problems .....	256
White or Dark Lines in Printout .....	257
Blurry or Smearred Printout .....	258
Faint Printout or Printout Has Gaps .....	259
Grainy Printout.....	260
Incorrect Colors .....	261
Solving Scanning Problems .....	262
Scanning Software Does Not Operate Correctly .....	262
Cannot Start Epson Scan 2 .....	263
Solving Scanned Image Quality Problems .....	264
Image Consists of a Few Dots Only.....	264
Line of Dots Appears in All Scanned Images.....	265
Straight Lines in an Image Appear Crooked .....	265
Image is Distorted or Blurry .....	265
Image Colors are Patchy at the Edges .....	266
Image is Too Dark .....	266
Back of Original Image Appears in Scanned Image .....	266
Ripple Patterns Appear in an Image .....	266
Image is Scanned Upside-Down .....	267
Scanned Image Colors Do Not Match Original Colors .....	267
Scan Area is Not Adjustable in Thumbnail Preview .....	267
Scanned Image Edges are Cropped .....	268
Solving Memory Card Problems.....	268
Memory Card Does Not Fit Into a Slot .....	268

Cannot View or Print Photos from a Memory Card or Device .....	268
Cannot Transfer Photos to or from a Memory Card or Device .....	269
Solving CD/DVD Problems.....	269
CD/DVD Jam Problems.....	269
Image Not Centered on CD/DVD.....	270
Ink Smears on CD/DVD.....	270
Faint Image on CD/DVD .....	270
Uninstall Your Product Software.....	271
Uninstalling Product Software - Windows .....	271
Uninstalling Product Software - Mac.....	272
Where to Get Help.....	273
<b>Technical Specifications .....</b>	<b>274</b>
Windows System Requirements .....	274
Mac System Requirements .....	275
Paper Specifications .....	275
Printable Area Specifications .....	276
Scanning Specifications .....	279
Ink Specifications .....	279
Memory Card Specifications .....	280
External USB Device Specifications.....	281
Dimension Specifications .....	281
Electrical Specifications .....	282
Environmental Specifications .....	282
Interface Specifications .....	282
Network Interface Specifications.....	283
Safety and Approvals Specifications .....	284
<b>Notices .....</b>	<b>285</b>
Important Safety Instructions.....	285
General Product Safety Instructions .....	285
Wireless Connection Safety Instructions .....	287
LCD Screen Safety Instructions.....	287
FCC Compliance Statement.....	287
Binding Arbitration and Class Waiver .....	288

Trademarks .....	291
Copyright Notice.....	292
A Note Concerning Responsible Use of Copyrighted Materials.....	293
Default Delay Times for Power Management for Epson Products .....	293
Copyright Attribution .....	293

---

## **ET-7750 User's Guide**

Welcome to the ET-7750 *User's Guide*.

For a printable PDF copy of this guide, [click here](#).

---

## Your Ink Tank System

You should visually check the ink levels in the product's ink tanks regularly. For optimum printing results, refill the ink tanks to the upper line at least once a year.

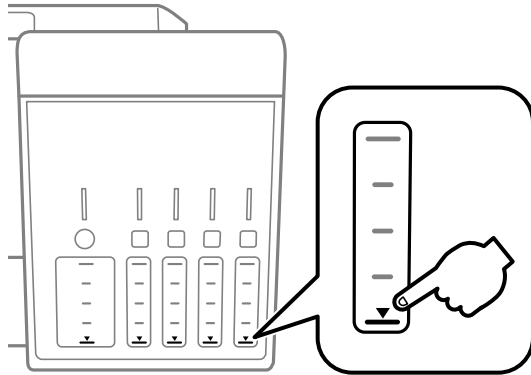

**Note:** The product has a low ink alert system. The accuracy of this system depends on the user refilling the ink tanks correctly. The product cannot directly measure the ink levels in the tanks; instead it estimates the amount of ink remaining by internally monitoring ink usage. The low ink alert system may generate inaccurate messages if the ink tanks are not refilled according to these instructions.

Visually check the ink levels in the product's ink tanks to confirm the actual ink levels. Continued use of the product when the ink is expended could damage the product.

To refill the ink tanks and reset the ink levels, click the link below.

### **Related topics**

[Refilling Ink](#)

---

## Product Basics

See these sections to learn about the basic features of your product.

[Using the Control Panel](#)

[Product Parts Locations](#)

[The Power Off and Sleep Timers](#)

[Epson Connect Solutions for Smartphones, Tablets, and More](#)

[Using AirPrint](#)

[Using Google Cloud Print](#)

[Using the Mopria Print Service](#)

[Android Printing Using the Epson Print Enabler](#)

[Using Fire OS Printing](#)

[Using Windows 10 Mobile Printing](#)

[Using Epson Print and Scan App with Windows Tablets](#)

## Using the Control Panel

See these sections to learn about the control panel and select control panel settings.

[Control Panel Buttons and Lights](#)

[Using the LCD Screen](#)

[Adjusting Control Panel Position](#)

[Changing LCD Screen Language](#)

[Turning On Quiet Mode](#)

**Parent topic:** [Product Basics](#)

## Control Panel Buttons and Lights

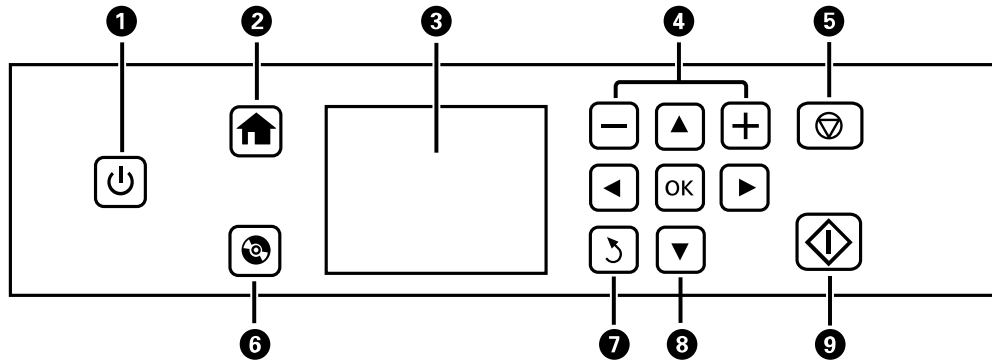

- 1    ⏻ power button and light
- 2    🏠 home button
- 3    LCD screen
- 4    + and - buttons
- 5    ⌫ cancel button
- 6    📀 CD button
- 7    ↶ back button
- 8    Arrow buttons and **OK** button
- 9    ⏪ start button

**Parent topic:** [Using the Control Panel](#)

## Using the LCD Screen

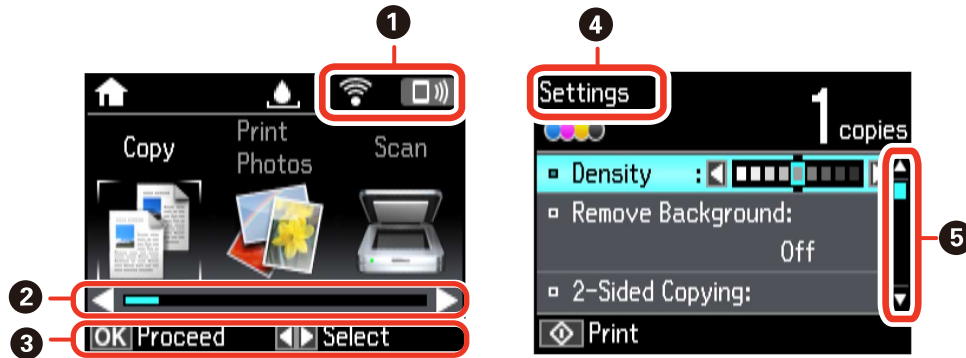

- 1 Displays the network status
- 2 You can scroll left and right when these arrows are displayed
- 3 Displays available button options
- 4 Screen name
- 5 You can scroll up and down when these arrows are displayed

To view a list of the icons and a description of their use, select **Help** > **Icon List** on the LCD screen.

**Parent topic:** [Using the Control Panel](#)

## Adjusting Control Panel Position

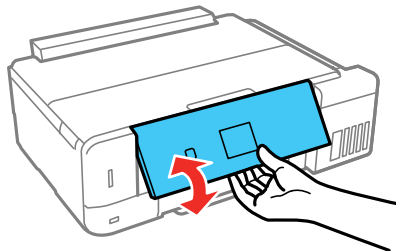

You can adjust the position of the control panel to make it easier to access. Raise or lower it to the desired angle as shown.



Parent topic: [Using the Control Panel](#)

## Changing LCD Screen Language

You can change the language used on the LCD screen.



1. Press the  home button, if necessary.
2. Press the arrow buttons to select **Settings** and press the **OK** button.
3. Select **Printer Setup** and press the **OK** button.
4. Select **Language** and press the **OK** button.
5. Select a language and press the **OK** button.
6. Press the  home button to exit.

Parent topic: [Using the Control Panel](#)

## Turning On Quiet Mode

You can reduce the noise the product makes by turning on the Quiet Mode setting.

**Note:** Turning on this setting may reduce print speed.

1. Press the  home button, if necessary.
2. Press the arrow buttons to select **Settings** and press the **OK** button.
3. Select **Printer Setup** and press the **OK** button.
4. Select **Quiet Mode** and press the **OK** button.
5. Select **On** and press the **OK** button.
6. Press the  home button to exit.

Parent topic: [Using the Control Panel](#)

## Product Parts Locations

See these sections to identify the parts on your product.

[Product Parts - Top](#)

[Product Parts - Front](#)

[Product Parts - Inside](#)

[Product Parts - Back](#)

Parent topic: [Product Basics](#)

## Product Parts - Top

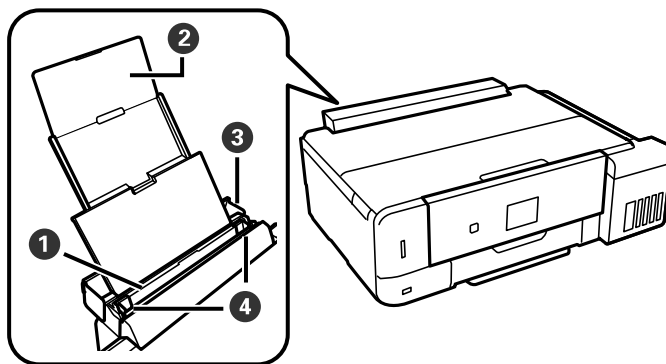

- 1 Rear paper feed slot
- 2 Rear paper feed support
- 3 Rear paper feed slot cover
- 4 Rear paper feed edge guides

Parent topic: [Product Parts Locations](#)

## Product Parts - Front

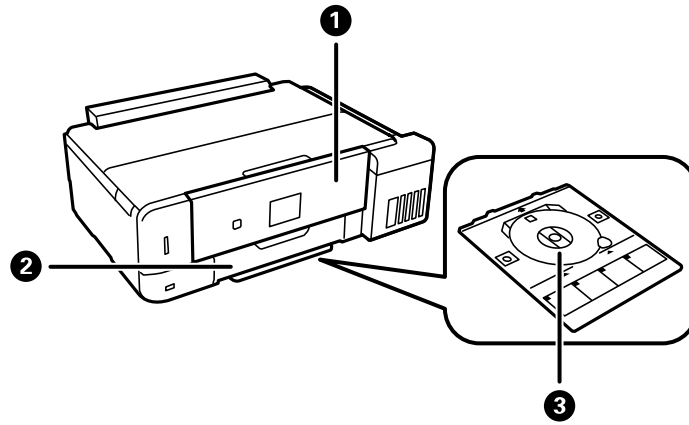

- 1 Control panel
- 2 Front cover
- 3 CD/DVD tray

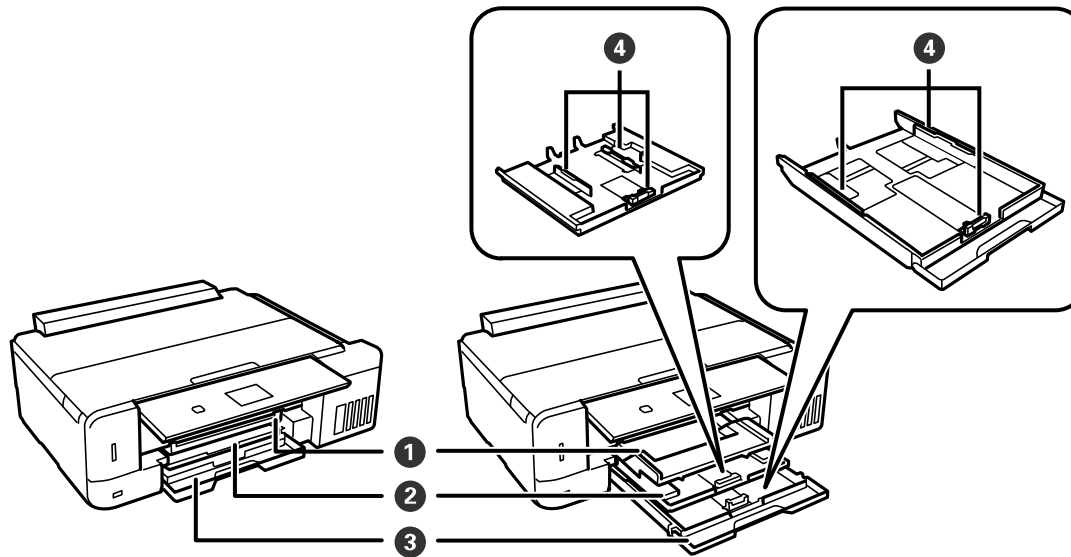

- 1 Output tray
- 2 Cassette 1 (upper cassette)
- 3 Cassette 2 (lower cassette)
- 4 Cassette edge guides

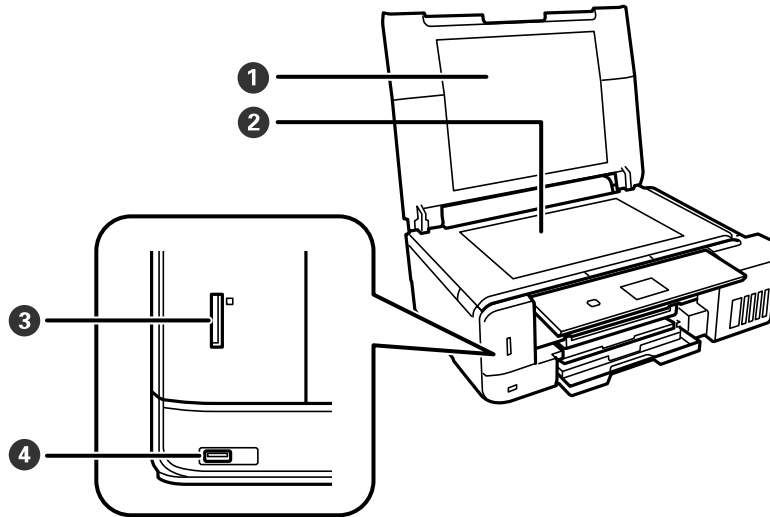

- 1 Document cover
- 2 Scanner glass
- 3 Memory card slot
- 4  USB Type A port for external devices

Parent topic: [Product Parts Locations](#)

## Product Parts - Inside

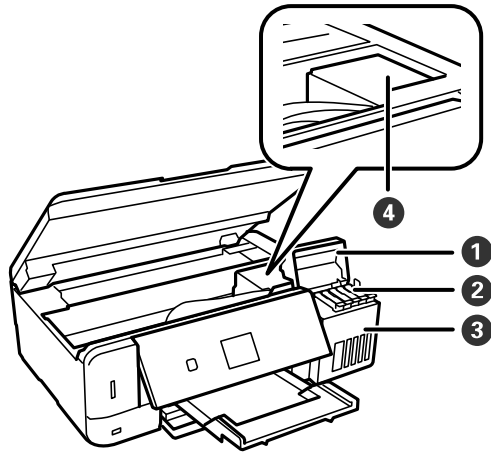

- 1 Ink tank cover
- 2 Ink tanks
- 3 Ink tank unit
- 4 Print head

**Parent topic:** [Product Parts Locations](#)

## Product Parts - Back

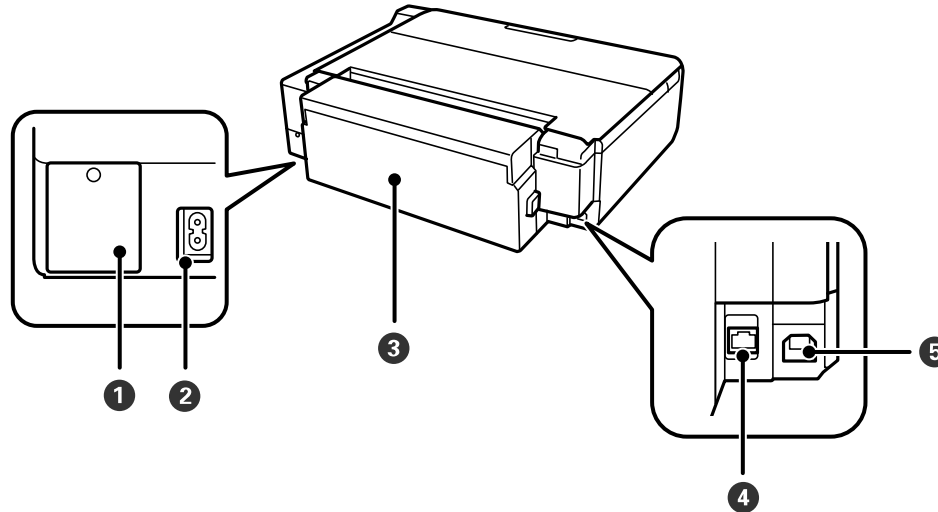

- 1 Maintenance box cover
- 2 AC inlet
- 3 Rear cover
- 4 **USB** port
- 5 **LAN** port

Parent topic: [Product Parts Locations](#)

## The Power Off and Sleep Timers

The product enters sleep mode or turns off automatically if it is not used for a period of time. You can adjust the time period before power management begins, but increasing the time reduces the product's energy efficiency.

[Changing the Power Off Timer Setting from the Control Panel](#)

[Changing the Sleep Timer Setting from the Control Panel](#)

Parent topic: [Product Basics](#)

## Changing the Power Off Timer Setting from the Control Panel

You can use the product's control panel to change the time period before the printer turns off automatically.

1. Press the **⬆️** home button, if necessary.
2. Press the arrow buttons to select **Settings** and press the **OK** button.
3. Select **Printer Setup** and press the **OK** button.
4. Select **Power Off Timer** and press the **OK** button.

You see this screen:



5. Select the length of time after which you want the product to automatically turn off when it is not in use and press the **OK** button.
6. Press the **⬆️** home button to exit.

**Parent topic:** [The Power Off and Sleep Timers](#)

## Changing the Sleep Timer Setting from the Control Panel

You can use the product's control panel to change the time period before the product enters sleep mode.

1. Press the **⬆️** home button, if necessary.
2. Press the arrow buttons to select **Settings** and press the **OK** button.
3. Select **Printer Setup** and press the **OK** button.

4. Select **Sleep Timer** and press the **OK** button.

You see this screen:



5. Select the time period you want before the product goes to sleep and press the **OK** button.
6. Press the **home** button to exit.

**Parent topic:** [The Power Off and Sleep Timers](#)

## Epson Connect Solutions for Smartphones, Tablets, and More

Use your smartphone, tablet, or computer to print and scan documents, photos, emails, and web pages from your home, office, or even across the globe.

**Note:** If you are using your Epson product with the Windows 10 S operating system, you cannot use the software described in this section. You also cannot download and install any Epson product software from the Epson website for use with Windows 10 S; you must obtain software only from the Windows Store.

Print from anywhere with these Epson Connect solutions:

- Epson Email Print
- Epson iPrint Mobile App
- Epson Remote Print

Scan and send a file as an email or upload it to an online service directly from your Epson product with Epson Scan to Cloud or the Epson iPrint Mobile App.

[Setting Up Epson Connect Services](#)  
[Using Epson Email Print](#)  
[Using the Epson iPrint Mobile App](#)  
[Using the Epson Creative Print Mobile App](#)  
[Using Epson Remote Print](#)  
[Using Epson Scan to Cloud](#)

**Parent topic:** [Product Basics](#)

## Setting Up Epson Connect Services

If you did not activate your product's email address for use with Epson Connect when you set up your product, you can activate it using the product control panel.

1. Press the  home button, if necessary.
2. Press the arrow buttons to select **Settings** and press the **OK** button.
3. Select **Epson Connect Services** and press the **OK** button.

You see this screen:

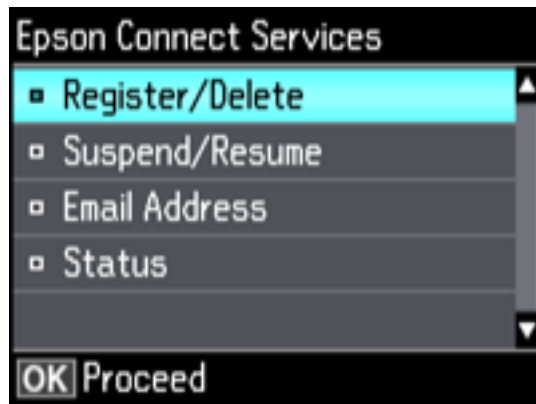

4. Select **Register/Delete** and press the **OK** button.
5. Select **Yes** and press the **OK** button.
6. Follow the instructions on the screen to activate your product's email address.

**Parent topic:** [Epson Connect Solutions for Smartphones, Tablets, and More](#)

## Using Epson Email Print

With Epson Email Print, you can print from any device that can send email, such as your smartphone, tablet, or laptop. Just activate your product's unique email address. When you want to print, attach a PDF, Microsoft Office document, or photo to an email and send it to your product. Both the email and the attachments will print automatically.

1. Connect your product to your network. See the link below.
2. If you did not already set up Email Print when you installed your product software, see the link below to use your product control panel to activate your unique email address. Or visit [epson.com/connect](http://epson.com/connect) (U.S), [epson.ca/connect](http://epson.ca/connect) (Canada), or [epsonconnect.com](http://epsonconnect.com) (Caribbean) to learn more about Email Print, create your Epson Connect account, and register your product to the Epson Connect service.
3. Now you are ready to send and print emails to your product's Email Print address.

**Note:** Go to [epsonconnect.com](http://epsonconnect.com) and log into your Epson Connect account to personalize your product's email, adjust print settings, and set up other Epson Connect services.

**Parent topic:** [Epson Connect Solutions for Smartphones, Tablets, and More](#)

### Related tasks

[Setting Up Epson Connect Services](#)

### Related topics

[Wi-Fi or Wired Networking](#)

## Using the Epson iPrint Mobile App

Use this free Apple and Android app to print and scan with networked Epson products. Epson iPrint lets you print PDFs, Microsoft Office documents, photos, and web pages over a wireless network. You can scan and save a file on your device, send it as an email, or upload it to an online service such as Box, Dropbox, Evernote, or Google Drive.

1. Connect your product to your wireless network. See the link below.
2. Visit [epson.com/connect](http://epson.com/connect) (U.S), [epson.ca/connect](http://epson.ca/connect) (Canada), or [epson.com.jm/connect](http://epson.com.jm/connect) (Caribbean) to learn more about Epson iPrint and check the compatibility of your mobile device.
3. Download Epson iPrint from the Apple App Store or Google Play.
4. Connect your mobile device to the same wireless network as your product.
5. Open Epson iPrint and select your Epson product.

Now you are ready to print or scan with your mobile device and your Epson product.

**Parent topic:** [Epson Connect Solutions for Smartphones, Tablets, and More](#)

**Related topics**

[Wi-Fi or Wired Networking](#)

## Using the Epson Creative Print Mobile App

Use this free Apple and Android app to do the following:

- Access and print your mobile device photos, including Instagram and Facebook photos
- Create custom greeting cards and stationery
- Print onto CD/DVDs
- Turn photos into coloring book templates

**Note:** Not all features may be supported by your product.

1. Connect your product to your wireless network. See the link below.
2. Visit [epson.com/connect](http://epson.com/connect) (U.S), [epson.ca/connect](http://epson.ca/connect) (Canada), or [epson.com.jm/connect](http://epson.com.jm/connect) (Caribbean) to learn more about Epson Creative Print and check the compatibility of your mobile device and your Epson product.
3. Download Epson Creative Print from the Apple App Store or Google Play.
4. Connect your mobile device to the same wireless network that your product is using.
5. Open Epson Creative Print.

Now you are ready to get creative with your mobile device and your Epson product.

**Parent topic:** [Epson Connect Solutions for Smartphones, Tablets, and More](#)

**Related topics**

[Wi-Fi or Wired Networking](#)

## Using Epson Remote Print

With Epson Remote Print software, you can print from your laptop or desktop computer to an Epson Email-enabled product anywhere in the world.

1. Connect your Epson product to your wireless network. See the link below.

2. If you did not already set up an Epson Connect account when you installed your product software, visit [epsonconnect.com](http://epsonconnect.com) to create your account and register your product to the Epson Connect service.

**Note:** Make a note of your product's email address.

3. Visit [epsonconnect.com](http://epsonconnect.com) to learn more about Remote Print and how to download the Remote Print Driver software.
4. Download and install the Remote Print software.
5. Enter the email address and optional access key of your Epson product during Remote Print setup.
6. Now you are ready to print remotely. Select the print command in your laptop or desktop computer application and choose the Remote Print option for your Epson product.

**Parent topic:** [Epson Connect Solutions for Smartphones, Tablets, and More](#)

#### **Related topics**

[Wi-Fi or Wired Networking](#)

## **Using Epson Scan to Cloud**

The Epson Scan to Cloud service allows you to scan and send a file as an email or upload it to an online service directly from your Epson product. Register an email address or online services such as Box, DropBox, Evernote, or Google Drive with your Epson Connect account.

1. Connect your Epson product to your network. See the link below.
2. If you did not already set up an Epson Connect account when you installed your product software, visit [epsonconnect.com](http://epsonconnect.com) to create your account and register your product to the Epson Connect service.

**Note:** Make a note of your product's email address and password.

3. Visit [epsonconnect.com](http://epsonconnect.com) to sign into your account with the email address and password you selected.
4. Select your product, select **Scan to Cloud**, and select **Destination List**.
5. Click **Add**, then follow the instructions on the screen to create your destination list.
6. Now you are ready to use Scan to Cloud. Select the setting for scanning to Scan to Cloud on your Epson product control panel.

**Parent topic:** [Epson Connect Solutions for Smartphones, Tablets, and More](#)

## Related topics

[Wi-Fi or Wired Networking](#)

## Using AirPrint

AirPrint enables instant wireless printing from iPhone, iPad, and iPod touch with the latest version of iOS, and Mac with the latest version of OS X or macOS.



**Note:** If you disabled paper configuration messages on your product control panel, you cannot use AirPrint. See the link below to enable the messages, if necessary.

1. Load paper in your product.
2. Set up your product for wireless printing. See the link below.
3. Connect your Apple device to the same wireless network that your product is using.
4. Print from your device to your product.

**Note:** For details, see the AirPrint page on the Apple website.

**Parent topic:** [Product Basics](#)

## Related topics

[Wi-Fi or Wired Networking](#)

## Using Google Cloud Print

With a Google Account, you can print from your Apple or Android device to your Epson product. You can also print from Chromebooks and the Google Chrome browser without drivers or cables.

1. Connect your Epson product to your wireless network. See the link below.
2. Note your product's IP address by checking your network status. See the link below.
3. Connect your computer or your Apple or Android device to the same wireless network as your Epson product.
4. Enter your product's IP address into the address bar of a web browser.

5. Select the **Google Cloud Print Services** option.

**Note:** If you don't see the **Google Cloud Print Services** option, turn your product off and back on. If the option still doesn't appear, select the **Firmware Update** option and follow the on-screen instructions to update your product.

6. Click **Register**.
7. Select the checkbox to agree to the Usage Advisory and click **Next**.
8. Click **OK** to launch the sign-in page.  
A separate browser window opens.
9. Enter your Google Account username and password and click **Sign in**, or, if you don't have an account, click **Sign up for a new Google Account** and follow the on-screen instructions.
10. Click **Finish printer registration** to complete setup and print a test page.

Your product is now linked to your Google Account and can be accessed from any Chromebook, computer, Apple or Android device with Internet access. Visit [Epson Support for Google Cloud Print \(U.S\)](#) or [Epson Support for Google Cloud Print \(Canada\)](#) for more information on using Google Cloud Print, or the [Google Cloud Print](#) website for a list of [supported apps](#).

[Setting Up Google Cloud Print on a Chromebook](#)

**Parent topic:** [Product Basics](#)

**Related tasks**

[Printing a Network Status Sheet](#)

**Related topics**

[Wi-Fi or Wired Networking](#)

## Setting Up Google Cloud Print on a Chromebook

With a Google Account, you can print from a Chromebook without drivers or cables.

1. Connect your Epson product to your wireless network. See the link below.
2. Turn on your Chromebook and connect it to the same wireless network as your product.

**Note:** See your Chromebook's documentation for details on connecting to a network.

3. Do one of the following:
  - Click **Add to Cloud Print** in the notification that appears in the corner of your Chromebook screen.  
  
**Note:** If you do not see a notification, check to see if a number appears in the status area at the lower-right corner of the screen. Click this number to open the notifications menu, then click **Add to Cloud Print**.
  - Open a web browser and enter **chrome://devices** in the address bar. Skip to step 4.
  - If you see a registration confirmation screen instead, click **Register**.
4. Click **Add Device**.
5. Click the **Register** button that appears next to your product.
6. Click **Register** on the confirmation screen. Your product's LCD screen displays a confirmation message.
7. Select **OK** or press the **OK** button on your product to confirm the Google Cloud Print connection and print a test page.

Your product is now linked to your Google Account and can be accessed from any Chromebook, iPhone, or Android phone with Internet access. Visit [Epson Support for Google Cloud Print \(U.S\)](#) or [Epson Support for Google Cloud Print \(Canada\)](#) for more information on using Google Cloud Print, or the [Google Cloud Print](#) website for a list of [supported apps](#).

**Parent topic:** [Using Google Cloud Print](#)

**Related topics**

[Wi-Fi or Wired Networking](#)

## Using the Mopria Print Service

You can use the Mopria Print Service to print from your Android phone or tablet (Android v4.4 or later) to your Epson product or any Mopria-certified product from other manufacturers. You can download the Mopria Print Service from Google Play.

**Note:** For details on the Mopria Print Service, [click here](#) (U.S) or [click here](#) (Canada).

1. Connect your Epson product to your wireless network. See the link below.

2. On your Android device, download the Mopria Print Service from Google Play.

**Note:** On some Samsung Galaxy devices, Mopria may come preinstalled.

3. Go to **Settings** on your Android device, select **Printing**, and enable the Mopria Print Service.
4. Connect your Android device to the same wireless network as your product.
5. Now you are ready to print. From an Android application such as Chrome or Gmail, tap the menu icon and select **Print**. Then select **All printers**, select your Epson product, adjust your print settings, and print.

**Parent topic:** [Product Basics](#)

**Related topics**

[Wi-Fi or Wired Networking](#)

## Android Printing Using the Epson Print Enabler

You can wirelessly print your documents, emails, photos, and web pages right from your Android phone or tablet (Android v4.4 or later). With a few taps, your Android device will discover your nearby Epson product and print.

1. Connect your Epson product to your wireless network. See the link below.
2. On your Android device, download the Epson Print Enabler plug-in from Google Play.
3. Go to **Settings** on your Android device, select **Printing**, and enable the Epson plug-in.
4. Connect your Android device to the same wireless network as your product.
5. Now you are ready to print. From an Android application such as Chrome or Gmail, tap the menu icon and print whatever is on the screen.

**Note:** If you do not see your product, tap **All Printers** and select your product.

**Parent topic:** [Product Basics](#)

**Related topics**

[Wi-Fi or Wired Networking](#)

## Using Fire OS Printing

You can wirelessly print from Amazon Fire tablets and phones to your nearby networked Epson product. There is no software to download, no drivers to install, and no cables to connect. With just a few taps in

Email, Calendar, Contacts, and WPS Office, you can send whatever is on the screen to an Epson product.

1. Connect your Epson product to your wireless network. See the link below.
2. Connect your Amazon device to the same wireless network as your product.
3. Now you are ready to print. From your Amazon application, tap the print option and select your product to print whatever is on the screen.

**Note:** If you see a message telling you that a plug-in is required, tap **OK** and tap **Download**. If your Amazon Fire product uses Fire OS 5 and above, your device automatically uses the built-in Mopria Print Service app to print.

Visit [epson.com/connect](http://epson.com/connect) (U.S), [epson.ca/connect](http://epson.ca/connect) (Canada), or [epson.com.jm/connect](http://epson.com.jm/connect) (Caribbean) to learn more about Fire OS Printing (one of many Epson Connect Partner Solutions) and check the compatibility of your mobile device.

**Parent topic:** [Product Basics](#)

**Related topics**

[Wi-Fi or Wired Networking](#)

## Using Windows 10 Mobile Printing

You can wirelessly print from Windows 10 Mobile tablets and phones to your nearby networked Epson product. There is no software to download, no drivers to install, and no cables to connect. Look for the print option in your Windows 10 application to send whatever is on the screen to an Epson product.

1. Connect your Epson product to your wireless network. See the link below.
2. Connect your Windows 10 Mobile device to the same wireless network as your product.
3. Now you are ready to print. From your Windows 10 application, tap the print option and select your product to print whatever is on the screen.

Visit [epson.com/connect](http://epson.com/connect) (U.S), [epson.ca/connect](http://epson.ca/connect) (Canada), or [epson.com.jm/connect](http://epson.com.jm/connect) (Caribbean) to learn more about Windows 10 Mobile Printing (one of many Epson Connect Partner Solutions) and check the compatibility of your mobile device.

**Parent topic:** [Product Basics](#)

**Related topics**

[Wi-Fi or Wired Networking](#)

## Using Epson Print and Scan App with Windows Tablets

You can use this free app to print photos and scan from your Windows (Windows 8 or higher) Surface RT or Pro tablet with networked Epson products. Epson Print and Scan App allows you to scan and capture images right to your tablet or to Microsoft OneDrive.

**Note:** The Epson Print and Scan App does not support Windows 10 Mobile printing.

1. Connect your Epson product to your wireless network. See the link below.
2. Download Epson Print and Scan App from the Microsoft Windows Store.
3. Connect your Windows tablet to the same wireless network as your product.
4. Open Epson Print and Scan App and select your Epson product.

Now you are ready to print photos or scan.

Visit [epson.com/connect](http://epson.com/connect) (U.S), [epson.ca/connect](http://epson.ca/connect) (Canada), or [epson.com.jm/connect](http://epson.com.jm/connect) (Caribbean) to learn more about Epson Print and Scan App.

**Parent topic:** [Product Basics](#)

**Related topics**

[Wi-Fi or Wired Networking](#)

---

## Wi-Fi or Wired Networking

See these sections to use your product on a Wi-Fi or wired network.

[Network Security Recommendations](#)

[Wi-Fi Infrastructure Mode Setup](#)

[Wi-Fi Direct Mode Setup](#)

[Wi-Fi Protected Setup \(WPS\)](#)

[Printing a Network Status Sheet](#)

[Changing or Updating Network Connections](#)

## Network Security Recommendations

To help deter unauthorized access to your product over a network, you should protect your network environment using appropriate security measures.

Security measures such as these can help deter threats such as loss of user data, use of telephone and fax lines, and other intrusions:

- **Enable security on your wireless LAN**

Enable the appropriate security on the wireless LAN you plan to use with your product. Network security such as a network password can deter interception of traffic over the wireless LAN. Your router may already have a default password enabled by your Internet service provider (ISP). See your ISP and router documentation for instructions on how to change the default password and better secure your network.

- **Connect your product only to a network protected by a firewall**

Connecting your product directly to the Internet may leave it vulnerable to security threats. Instead, connect it to a router or other network connection protected by a firewall. Your router may already have a firewall set up by your Internet service provider; check with your ISP for confirmation. For best results, set up and use a private IP address for your network connection.

- **Change the default administrator password on your product**

If your product has an option to set an administrator password, change the default administrator password to deter access by unauthorized users to personal data stored on your product, such as IDs, passwords, and contact lists.

Parent topic: [Wi-Fi or Wired Networking](#)

## Wi-Fi Infrastructure Mode Setup

You can set up your product to communicate with your computer using a wireless router or access point. The wireless router or access point can be connected to your computer over a wireless or wired network.

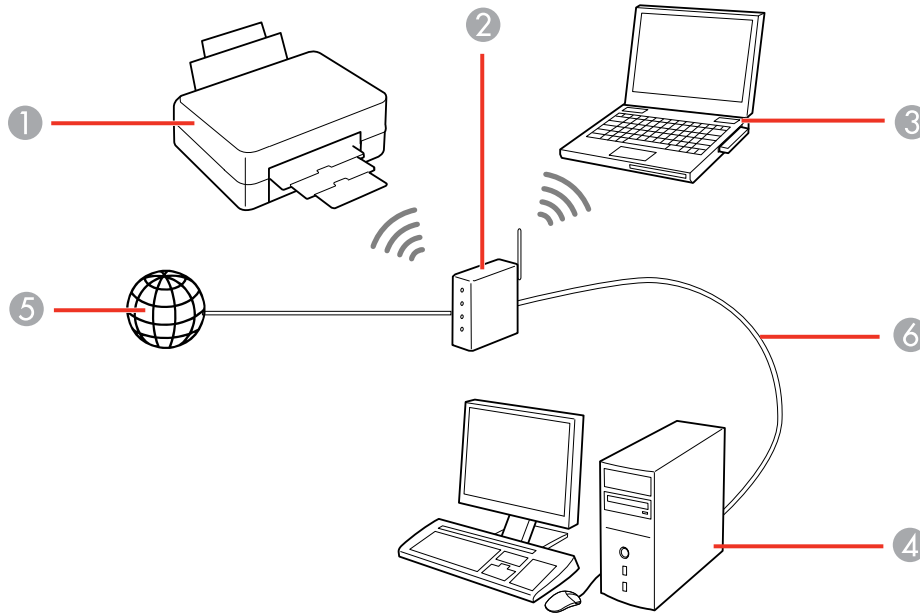

- 1 Epson product
- 2 Wireless router or access point
- 3 Computer with a wireless interface
- 4 Computer
- 5 Internet
- 6 Ethernet cable (used only for wired connection to the wireless router or access point)

[Selecting Wireless Network Settings from the Control Panel](#)

**Parent topic:** [Wi-Fi or Wired Networking](#)

## Selecting Wireless Network Settings from the Control Panel

You can select or change wireless network settings using your product control panel.

To install your product on a wireless network, follow the instructions on the *Start Here* sheet and install the necessary software. The installer program guides you through network setup.

1. Press the **⬆** home button, if necessary.
2. Press the arrow buttons to select **Wi-Fi Setup** and press the **OK** button.
3. Press the **OK** button to select **Wi-Fi (Recommended)**.
4. Press the **OK** button.

You see this screen:

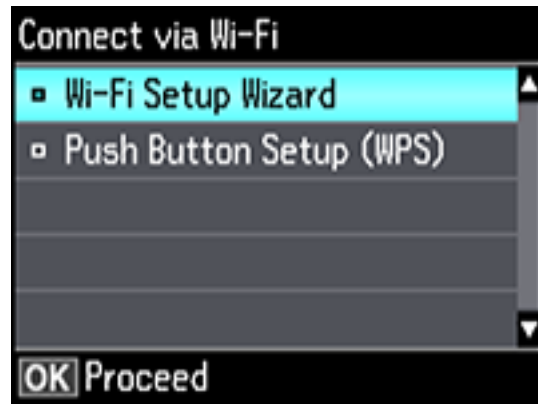

5. Select **Wi-Fi Setup Wizard** and press the **OK** button.
6. Press the up or down arrow buttons to select the name of your wireless network and press the **OK** button. If you do not see your wireless network's name, you can enter it manually.

**Note:** To enter the wireless network name manually, select **Other Networks** and press the **OK** button. Enter your network name as described in the next step.

7. Enter your wireless password (or network name and then password).



- Press the arrow buttons to highlight a character or a function button displayed on the keypad. Then press the **OK** button to select it.
  - To change the case of letters or select symbols, select **AB12** (uppercase), **ab12** (lowercase), or **Symbol** and press the **OK** button. Then highlight a number or symbol and press the **OK** button to select it.
  - To enter a space, select **Space** and press the **OK** button.
  - To delete characters, select the back arrow and press the **OK** button.
  - When you finish entering characters, select **Done** and press the **OK** button.
8. Press the **OK** button to confirm Wi-Fi settings.
  9. If you want to print a network status report, select **Yes** and press the **OK** button. (Otherwise, select **No**.)

Your product should now be connected to the network.

**Note:** If the Wi-Fi connection symbol does not appear on the LCD screen, you may have selected the wrong network name or entered the password incorrectly. Repeat these steps to try again.

**Parent topic:** [Wi-Fi Infrastructure Mode Setup](#)

**Related topics**

[Changing or Updating Network Connections](#)

## Wi-Fi Direct Mode Setup

You can set up your product to communicate directly with your computer or another device without requiring a wireless router or access point.

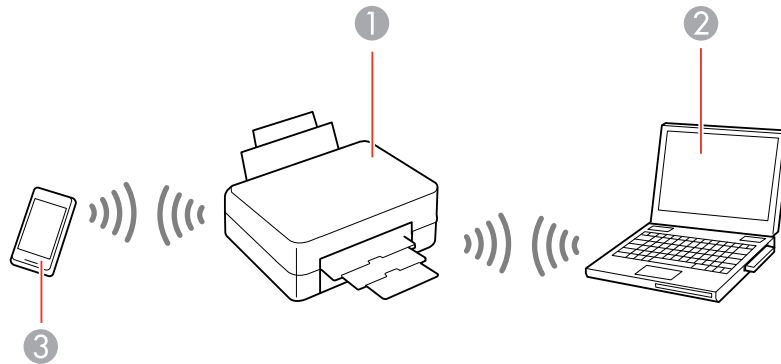

- 1 Epson product
- 2 Computer with a wireless interface
- 3 Other wireless device

Your product enters access point mode and the product itself acts as the network access point for up to 4 devices. When operating in this mode, your product displays the Wi-Fi Direct connection symbol on the LCD screen.

**Note:** Connected devices cannot communicate with each other via the connection to your product.

[Enabling Wi-Fi Direct Mode](#)

**Parent topic:** [Wi-Fi or Wired Networking](#)

## Enabling Wi-Fi Direct Mode

You can enable Wi-Fi Direct mode to allow direct communication between your product and computer or other devices without a wireless router or access point.

1. Press the  home button, if necessary.
2. Press the arrow buttons to select **Wi-Fi Setup** and press the **OK** button.

3. Press the arrow buttons to select **Wi-Fi Direct** and press the **OK** button.
4. Press the **OK** button.
5. Press the **OK** button again.
6. Press the **OK** button to confirm the Wi-Fi settings.

You see a screen like this:

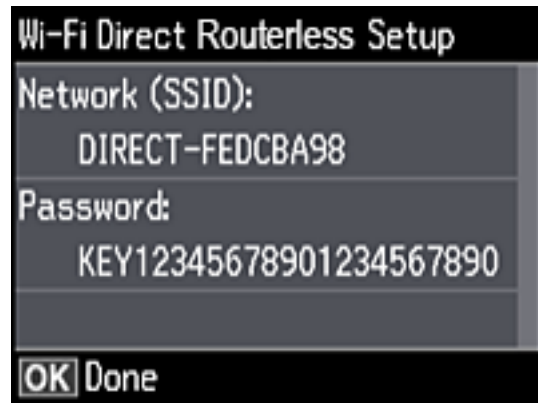

7. Press the **OK** button.
8. Press the **OK** button to exit.

You see the  connection symbol on the LCD screen and should be able to connect to your product directly from your computer or device, and then print. If you are printing from a computer, make sure you installed the network software as described on the *Start Here* sheet.

**Note:** Make a note of the SSID and password that appear.

If the  connection symbol is not displayed on the LCD screen, Wi-Fi Direct mode is not enabled. Repeat these steps to try again.

[Changing the Wi-Fi Direct Mode Password](#)

**Parent topic:** [Wi-Fi Direct Mode Setup](#)

## Changing the Wi-Fi Direct Mode Password

You can change the Wi-Fi Direct Mode password from the product's control panel.

1. Press the **⬆️** home button, if necessary.
2. Press the arrow buttons to select **Wi-Fi Setup** and press the **OK** button.
3. Press the arrow buttons to select **Wi-Fi Direct** and press the **OK** button.
4. Press the **OK** button.
5. Press the **OK** button again.
6. Press the right arrow button to select **Modify**.

**Note:** If you have already connected devices or computers to your product via Wi-Fi Direct, they will be disconnected when you change the password.

7. Select **Yes**.
8. Enter a new password.

**Note:** The password must be at least 8 and no more than 22 characters long.



- Press the arrow buttons to highlight a character or a function button displayed on the keypad. Then press the **OK** button to select it.

- To change the case of letters or select symbols, select **AB12** (uppercase), **ab12** (lowercase), or **Symbol** and press the **OK** button. Then highlight a number or symbol and press the **OK** button to select it.
  - To enter a space, select **Space** and press the **OK** button.
  - To delete characters, select the back arrow and press the **OK** button.
  - When you finish entering characters, select **Done** and press the **OK** button.
9. Press the **OK** button to confirm the Wi-Fi settings.

You see a screen like this:

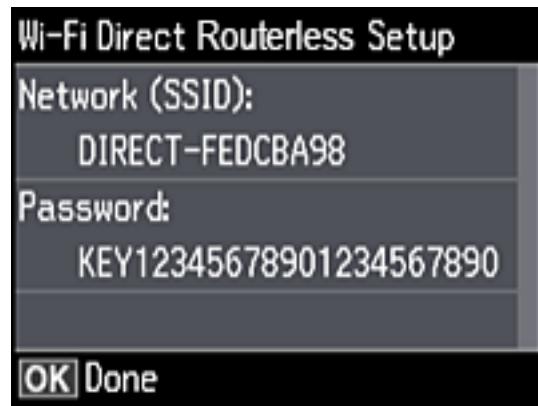

10. Press the **OK** button.
11. Press the **OK** button to exit.

**Parent topic:** [Enabling Wi-Fi Direct Mode](#)

## Wi-Fi Protected Setup (WPS)

If your network uses a WPS-enabled wireless router or access point, you can quickly connect your product to the network using Wi-Fi Protected Setup (WPS).

**Note:** To check if your router is WPS-enabled, look for a button labeled **WPS** on your router or access point. If there is no hardware button, there may be a virtual WPS button in the software for the device. Check your network product documentation for details.

[Using WPS to Connect to a Network](#)

Parent topic: [Wi-Fi or Wired Networking](#)

## Using WPS to Connect to a Network

If you have a WPS-enabled wireless router or access point, you can use Wi-Fi Protected Setup (WPS) to connect your product to the network.

1. On the product, press the  home button, if necessary.
2. Press the arrow buttons to select **Settings** and press the **OK** button.
3. Select **Network Settings** and press the **OK** button.
4. Select **Wi-Fi Setup** and press the **OK** button.



5. Select **Push Button Setup (WPS)** and press the **OK** button.
6. Follow the instructions on the LCD screen to complete WPS setup.

Your product should now display a WiFi symbol on the LCD screen. If it does not, repeat these steps to try again.

Parent topic: [Wi-Fi Protected Setup \(WPS\)](#)

## Printing a Network Status Sheet

You can print a network status sheet to help you determine the causes of any problems you may have using your product on a network. Make sure paper is loaded in the cassette.

1. Press the  home button, if necessary.

2. Press the arrow buttons to select **Settings** and press the **OK** button.
3. Select **Network Settings** and press the **OK** button.
4. Select **Network Status** and press the **OK** button.

You see a screen like this:

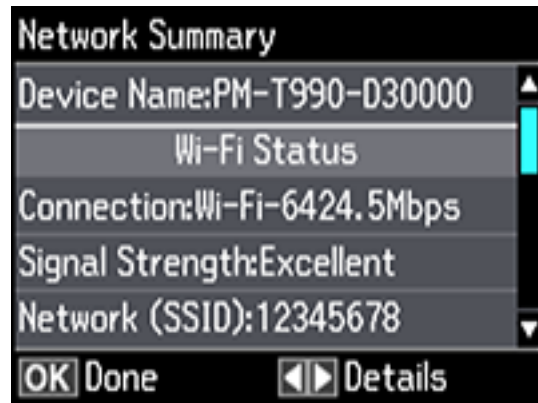

**Note:** If you are connected to a network, the signal strength is also displayed.

5. Press the left or right arrow button to view additional options.
6. Press the up or down arrow buttons to select **Print Status Sheet** and press the **OK** button.
7. Press the  start button to print the network status sheet.

(Press the  cancel button if you want to cancel the operation.)

Examine the settings shown on the network status sheet to diagnose any problems you have.

**Parent topic:** [Wi-Fi or Wired Networking](#)

## Changing or Updating Network Connections

See these sections to change or update how your product connects to a network.

[Accessing the Web Config Utility](#)

[Changing a USB Connection to a Wi-Fi Connection](#)

[Changing a Wi-Fi Connection to a Wired Network Connection](#)

[Connecting to a New Wi-Fi Router](#)

## [Disabling Wi-Fi Features](#)

**Parent topic:** [Wi-Fi or Wired Networking](#)

### **Accessing the Web Config Utility**

You can select your product's network settings and confirm its operating status using a web browser. You do this by accessing your product's built-in Web Config utility from a computer or other device that is connected to the same network as your product.

1. Print a network status sheet.
2. Locate the IP address for your product that is listed on the network status sheet.
3. On a computer or other device connected to the same network as your product, open a web browser.
4. Enter your product's IP address into the address bar.

You see the available Web Config utility options.

**Parent topic:** [Changing or Updating Network Connections](#)

#### **Related tasks**

[Printing a Network Status Sheet](#)

### **Changing a USB Connection to a Wi-Fi Connection**

If you have already connected your product to your computer using a USB connection, you can change to a Wi-Fi connection.

1. Disconnect the USB cable from your product.
2. Uninstall your product software.
3. Download and install your product software from the Epson website using the instructions on the *Start Here* sheet.

**Parent topic:** [Changing or Updating Network Connections](#)

#### **Related concepts**

[Uninstall Your Product Software](#)

### **Changing a Wi-Fi Connection to a Wired Network Connection**

If you have already connected your product to your computer wirelessly, you can change to a wired network connection if necessary.

1. Disable your product's Wi-Fi features.

2. Connect one end of an Ethernet network cable to the product's **LAN** port.
3. Connect the other end to any available LAN port on your router or access point.
4. Uninstall your product software.
5. Download and install your product software from the Epson website.
6. Follow the on-screen instructions to install the software.
7. When you see the Select Your Connection screen, select **Wired network connection**.
8. If you see a Select Setup Option screen, select **Set up printer for the first time**.
9. Continue following the rest of the on-screen instructions.

**Parent topic:** [Changing or Updating Network Connections](#)

#### **Related tasks**

[Disabling Wi-Fi Features](#)

## **Connecting to a New Wi-Fi Router**

If you change the wireless router you have been using on your network, you need to update your product's Wi-Fi connection to the new router.

**Note:** If you switch to a 5 GHz wireless router, set the router to operate in dual band (2.4 GHz and 5 GHz) mode. See your router documentation for instructions.

1. Do one of the following:
  - **Windows:** Uninstall your product software.
  - **Mac:** Go to the next step.
2. Download and install your product software from the Epson website using the instructions on the *Start Here* sheet.

**Parent topic:** [Changing or Updating Network Connections](#)

#### **Related concepts**

[Uninstall Your Product Software](#)

## **Disabling Wi-Fi Features**

You may need to disable your product's Wi-Fi features if you change your network connection type or need to solve a problem with your network connection.

**Note:** Before disabling Wi-Fi features, make a note of your product's SSID (network name) and password, and any network settings selected for the Epson Connect services you may use.

1. Press the **⬆** home button, if necessary.
2. Press the arrow buttons to select **Settings** and press the **OK** button.
3. Select **Network Settings** and press the **OK** button.
4. Select **Wi-Fi Setup** and press the **OK** button.

You see this screen:



5. Select **Disable Wi-Fi** and press the **OK** button.
6. Select **Yes** and press the **OK** button to disable Wi-Fi.

**Parent topic:** [Changing or Updating Network Connections](#)

---

# Loading Paper

Before you print, load paper for the type of printing you will do.

[Loading Paper in Cassette 1 \(Upper Cassette\)](#)

[Loading Paper in Cassette 2 \(Lower Cassette\)](#)

[Loading Paper and Envelopes in the Rear Paper Feed Slot](#)

[Selecting the Paper Settings for Each Source - Control Panel](#)

[Turning Off the Paper Setting Alert](#)

[Paper Loading Capacity](#)

[Available Epson Papers](#)

[Borderless Paper Type Compatibility](#)

[Paper or Media Type Settings - Printer Software](#)

## Loading Paper in Cassette 1 (Upper Cassette)

You can load photo paper in these sizes in the upper paper cassette:

- 3.5 × 5 inches (89 × 127 mm)
- 4 × 6 inches (102 × 152 mm)
- 5 × 7 inches (127 × 178 mm)
- 16:9 wide (4 × 7.1 inches [102 × 181 mm])
- A6 (4.1 × 5.8 inches [105 × 148 mm])

**Note:** Do not remove or insert the paper cassette during printing.

1. Close the output tray, if necessary.

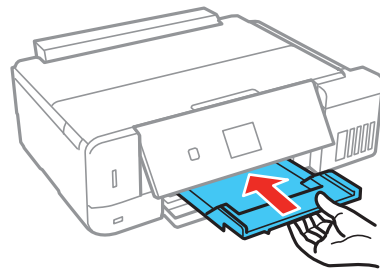

**Note:** As you slide in the output tray, there may be slight resistance and noise. This is normal.

2. Raise the control panel.

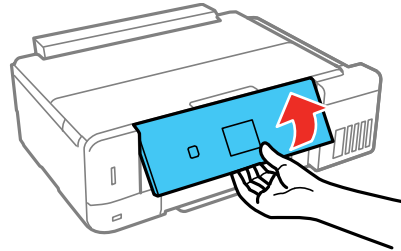

3. Open the front cover.

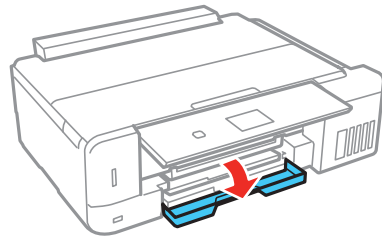

4. Pull out the upper paper cassette. The upper cassette is labeled as shown.

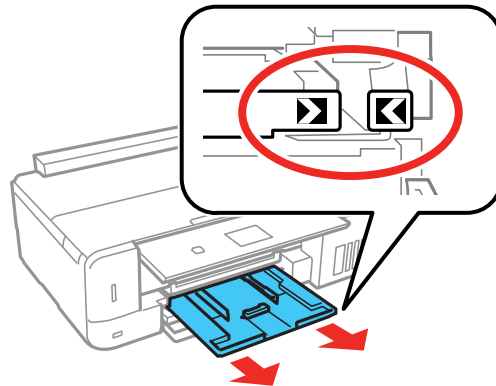

**Note:** If the cassette is too far inside the product to reach, turn off your product and turn it back on again to reset the cassette's position.

5. Slide the edge guides outward.

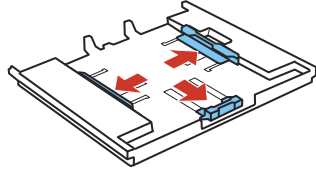

6. Set the front edge guide to the position for the paper size you are using.

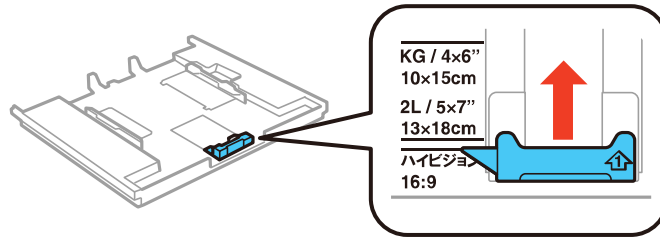

7. Insert paper in the cassette with the glossy or printable side facedown.

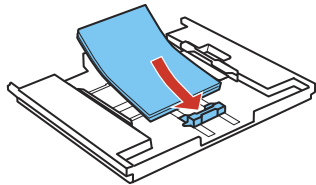

**Note:** Make sure the paper is loaded against the front edge guide and does not extend beyond the triangle symbol at the rear of the cassette.

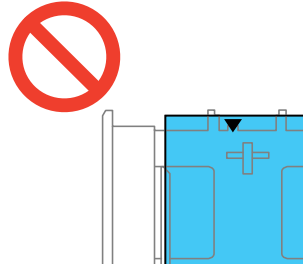

8. Slide the side edge guides against the paper, but not too tightly.

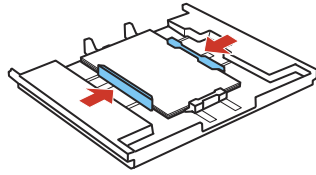

**Note:** Make sure the paper fits under the tabs on the edge guides.

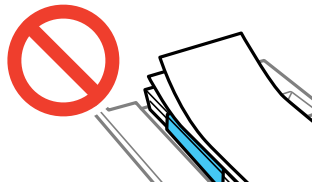

9. Keeping the cassette flat, insert it into your product until the arrow marks on the tray and product line up.

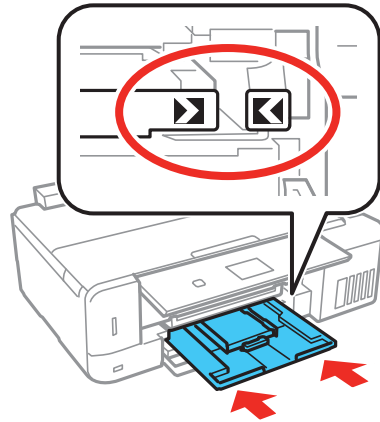

10. Lower the control panel and pull out the output tray.

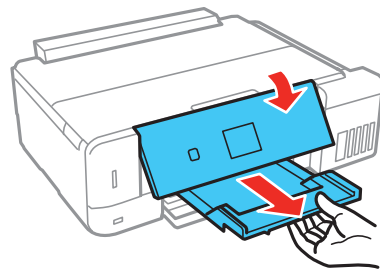

11. Select the size and type of paper you just loaded on the product LCD screen.

Always follow these paper loading guidelines:

- Load only the recommended number of sheets.
- Load paper short edge first and printable side facedown.
- Make sure the paper is under the tabs on the edge guides and not sticking out from the end of the cassette.
- Check the paper package for any additional loading instructions.

**Parent topic:** [Loading Paper](#)

**Related references**

[Paper Loading Capacity](#)

[Paper or Media Type Settings - Control Panel](#)

**Related tasks**

[Loading Paper in Cassette 2 \(Lower Cassette\)](#)

[Loading Paper and Envelopes in the Rear Paper Feed Slot](#)

## Loading Paper in Cassette 2 (Lower Cassette)

You can load paper up to this size in the lower paper cassette: Legal (8.5 × 14 inches [216 × 356 mm]).

**Note:** Do not remove or insert the paper cassette during printing.

1. Close the output tray, if necessary.

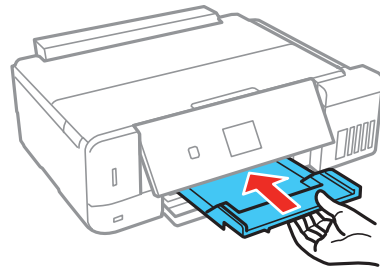

**Note:** As you slide in the output tray, there may be slight resistance and noise. This is normal.

2. Raise the control panel.

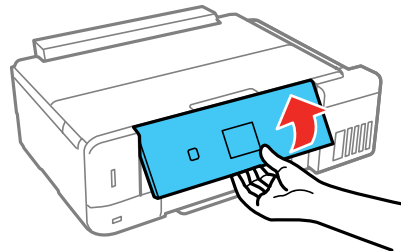

3. Open the front cover.

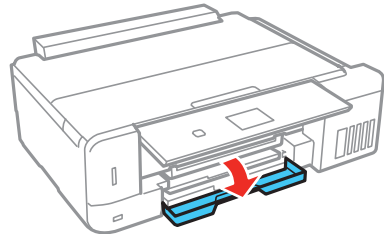

4. Pull on the front cover to pull out the lower paper cassette.

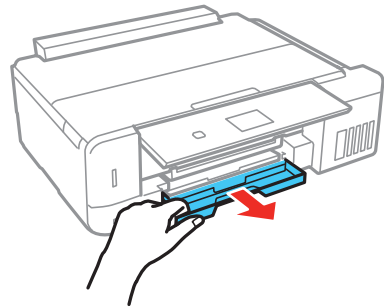

5. Slide the edge guides outward.

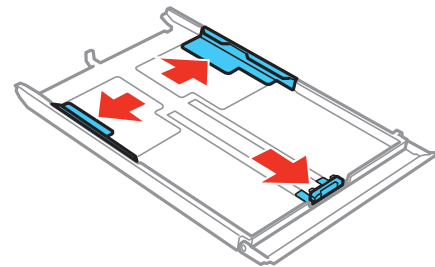

6. Set the front edge guide to the paper size you are using.

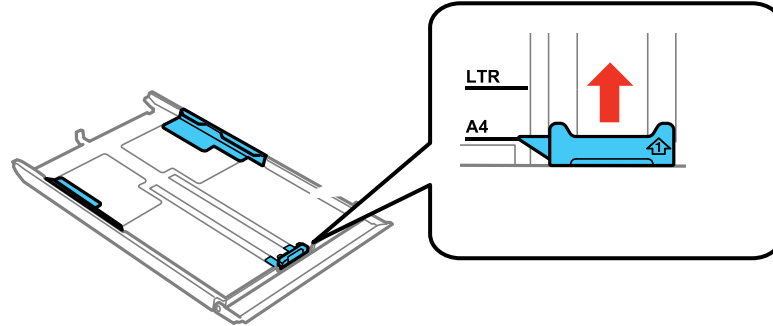

7. Do one of the following:

- Insert paper with the glossy or printable side face down.

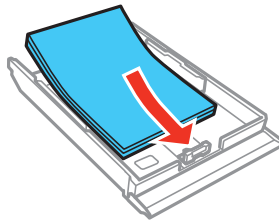

- Insert up to 10 envelopes, printable side down and flap edge left, as shown.

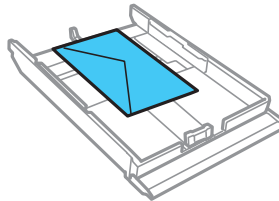

- For legal-size paper, remove the CD/DVD tray from the product. Press the button on the cassette and extend it as shown. Load paper with the glossy or printable side facedown.

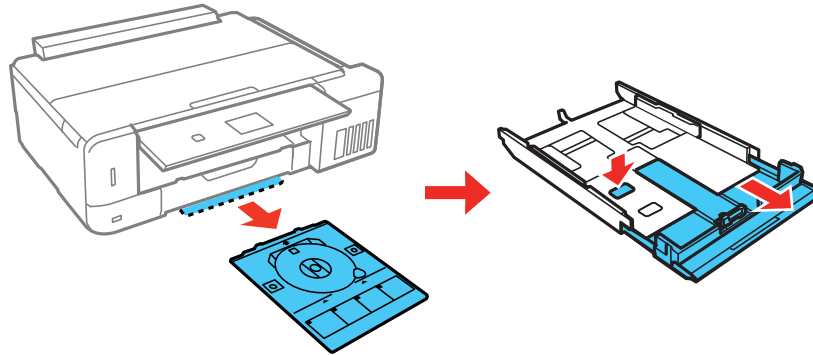

**Note:** Make sure the paper is loaded against the front edge guide and does not extend beyond the triangle symbol at the rear of the cassette.

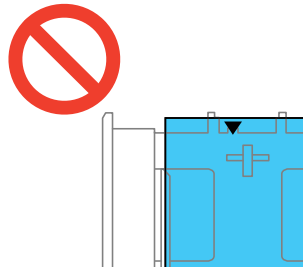

8. Slide the side edge guides against the paper, but not too tightly.

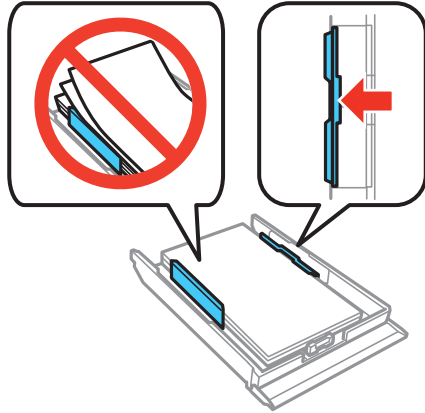

**Note:** Make sure the paper fits under the tabs on the edge guides.

9. Keep the cassette flat as you insert it into your product.

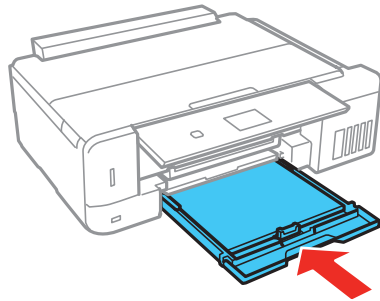

**Note:** Leave enough space in front of the product for the paper to be fully ejected.

10. Lower the control panel and pull out the output tray.

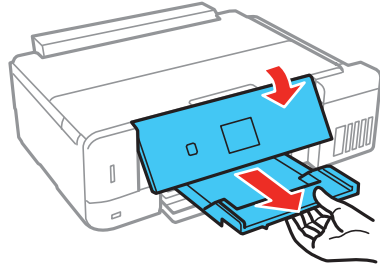

11. Select the size and type of paper you just loaded on the product LCD screen.

Always follow these paper loading guidelines:

- Load only the recommended number of sheets.
- Load paper short edge first and printable side down.
- Make sure the paper is under the tabs on the edge guides and not sticking out from the end of the cassette.
- If you have trouble loading a stack of envelopes, press each envelope flat before loading it or load one envelope at a time.
- If print quality declines when printing multiple envelopes, try loading one envelope at a time.
- Check the paper package for any additional loading instructions.

**Parent topic:** [Loading Paper](#)

**Related references**

[Paper Loading Capacity](#)

[Paper or Media Type Settings - Control Panel](#)

**Related tasks**

[Loading Paper in Cassette 1 \(Upper Cassette\)](#)

[Loading Paper and Envelopes in the Rear Paper Feed Slot](#)

## Loading Paper and Envelopes in the Rear Paper Feed Slot

You can load 10 sheets of paper or envelopes in the rear paper feed slot.

1. Raise the control panel.

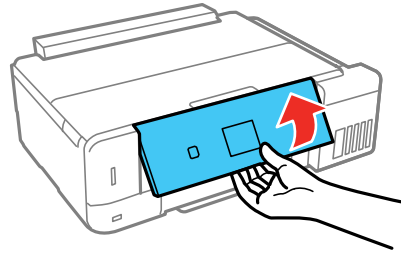

2. Open the front cover.

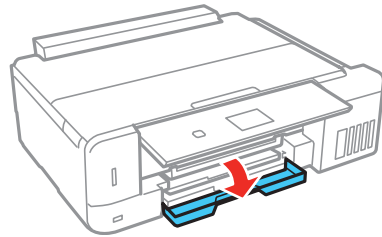

3. Pull out the output tray and lower the control panel.

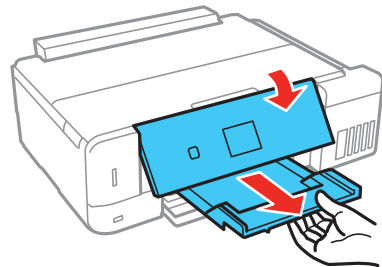

4. Open the rear paper feed slot cover.

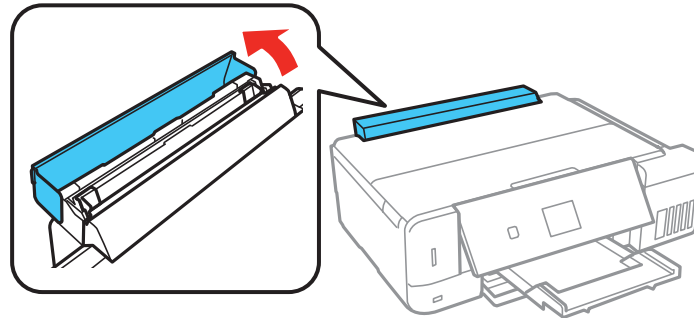

5. Extend the rear paper feed support and then tilt it backwards.

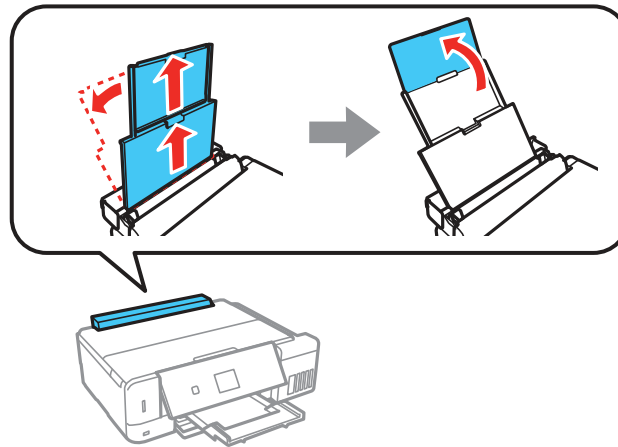

6. Slide out the edge guides.

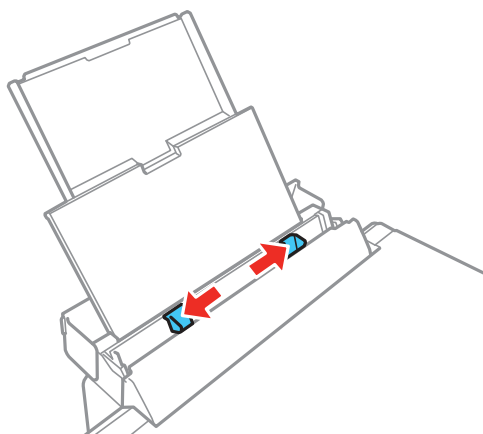

7. Do one of the following:

- Load paper with the printable side faceup at the center of the rear paper feed slot.

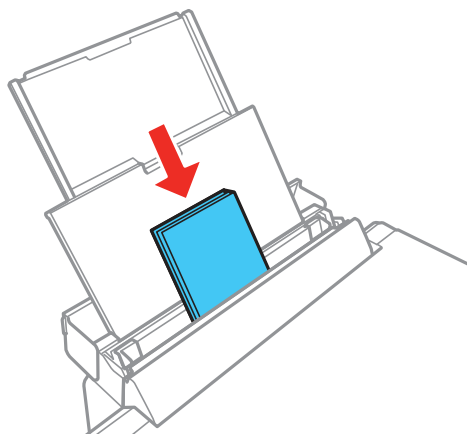

- Load envelopes short edge first with the flap facing down and the flap edge to the left at the center of the rear paper feed slot.

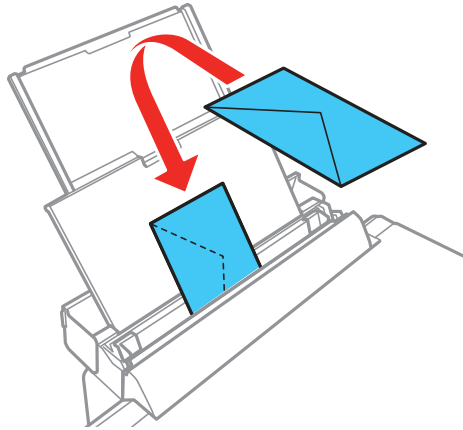

8. Slide the edge guides against the paper or envelopes, but not too tightly.

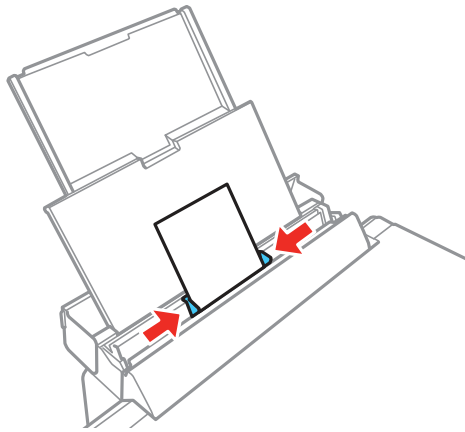

9. Confirm the paper size and type displayed on the LCD screen and make any changes, if necessary.

Always follow these paper loading guidelines:

- Do not load more than the maximum number of sheets or envelopes specified for the paper type.
- Load paper short edge first, no matter which way your document faces.
- Load the printable side faceup.

- Load letterhead or pre-printed paper top edge first.
- Check the paper package for any additional loading instructions.

**Note:** You can load a sheet of binder paper with holes on one of the long edges, but not for automatic 2-sided printing.

**Parent topic:** [Loading Paper](#)

**Related references**

[Paper Loading Capacity](#)

[Paper or Media Type Settings - Control Panel](#)

**Related tasks**

[Loading Paper in Cassette 1 \(Upper Cassette\)](#)

[Loading Paper in Cassette 2 \(Lower Cassette\)](#)

## Selecting the Paper Settings for Each Source - Control Panel

You can change the default paper size and paper type for each source using the control panel on the product.

1. Press the  home button, if necessary.
2. Press the arrow buttons to select **Settings** and press the **OK** button.
3. Select **Printer Setup** and press the **OK** button.
4. Select **Paper Source Setting** and press the **OK** button.

You see this screen:

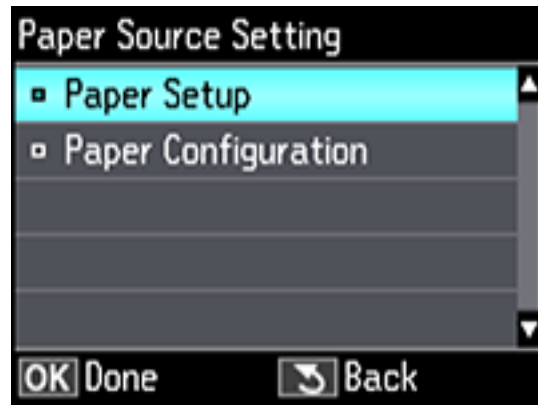

**Note:** To turn off the automatic display of the paper settings selection screen after paper is loaded in the cassettes, set the **Paper Configuration** setting to **Off**.

5. Select **Paper Setup** and press the **OK** button.
6. Select the paper source you want to change.
7. Select **Paper Size**.
8. Select the paper size you loaded.
9. Select **Paper Type**.
10. Select the paper type you loaded.
11. Press the ↩ back button to select another paper source to change, or press the 🏠 home button to exit.

[Paper or Media Type Settings - Control Panel](#)

**Parent topic:** [Loading Paper](#)

## Paper or Media Type Settings - Control Panel

For this paper	Select this Paper Type setting
Plain paper Epson Bright White Paper Epson Iron-on Cool Peel Transfer paper Epson Photo Quality Self-adhesive Sheets	<b>Plain Paper</b>
Epson Ultra Premium Photo Paper Glossy	<b>Ultra Glossy</b>
Epson Premium Photo Paper Glossy	<b>Prem. Glossy</b>
Epson Photo Paper Glossy	<b>Glossy</b>
Epson Presentation Paper Matte	<b>Presentation Matte</b>
Epson Premium Photo Paper Semi-gloss	<b>Prem. Semi-Gloss</b>
Epson Ultra Premium Photo Paper Luster	<b>Ultra Luster</b>
Epson Premium Presentation Paper Matte Epson Premium Presentation Paper Matte Double-sided Epson Ultra Premium Presentation Paper Matte Epson Brochure & Flyer Paper Matte Double-sided	<b>Prem. Matte</b>
Epson Velvet Fine Art Paper	<b>Velvet Fine Art Paper</b>
Envelopes	<b>Envelope</b>

Parent topic: [Selecting the Paper Settings for Each Source - Control Panel](#)

## Turning Off the Paper Setting Alert

The Paper Setting Alert warns you when the paper settings do not match the paper you loaded. You can turn off this feature from the product's control panel.

1. Press the  home button, if necessary.
2. Press the arrow buttons to select **Settings** and press the **OK** button.
3. Select **Guide Functions** and press the **OK** button.

You see this screen:

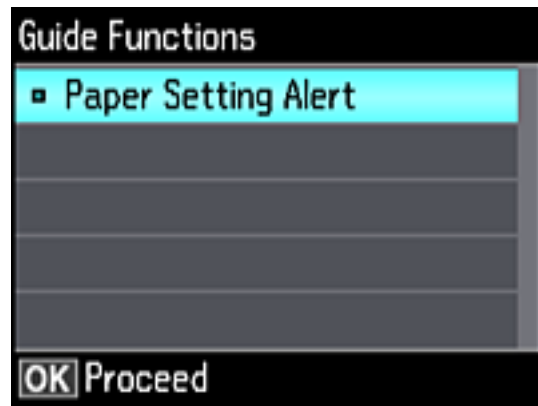

4. Select **Paper Setting Alert** and press the **OK** button.
5. Select **Off** and press the **OK** button.
6. Press the **⬆** home button to exit.

Parent topic: [Loading Paper](#)

## Paper Loading Capacity

See the table here for the loading capacity of the paper cassettes and rear paper feed slot.

Paper type	Load up to this many sheets		
	Cassette 1 (upper cassette)	Cassette 2 (lower cassette)	Rear Paper Feed Slot
Plain paper	20 sheets	Half Letter (5.5 × 8.5 inches [140 × 216 mm]), Letter (8.5 × 11 inches [216 × 279 mm]), A4 (8.3 × 11.7 inches [210 × 297 mm]), or Legal (8.5 × 14 inches [216 × 356 mm]) size: Up to the line indicated by the triangle symbol on the edge guide  A6 (4.1 × 5.8 inches [105 × 148 mm]): 20 sheets	10 sheets
Epson Bright White Paper	—	80 sheets	10 sheets
Epson Presentation Paper Matte Epson Premium Presentation Paper Matte Epson Ultra Premium Presentation Paper Matte	—	20 sheets	5 sheets
Epson Photo Paper Glossy Epson Premium Photo Paper Glossy Epson Ultra Premium Photo Paper Glossy Epson Premium Photo Paper Semi-gloss Epson Ultra Premium Photo Paper Luster	20 sheets	20 sheets	5 sheets

Paper type	Load up to this many sheets		
	Cassette 1 (upper cassette)	Cassette 2 (lower cassette)	Rear Paper Feed Slot
Epson Premium Presentation Paper Matte Double-sided Epson Photo Quality Self-adhesive Sheets Epson Iron-on Cool Peel Transfer paper Epson Brochure & Flyer Paper Matte Double-sided	—	1 sheet	1 sheet
Epson Velvet Fine Art Paper	—	—	1 sheet
Envelopes	—	10 envelopes	5 envelopes

Parent topic: [Loading Paper](#)

## Available Epson Papers

You can purchase genuine Epson ink and paper at [epson.com](http://epson.com) (U.S. sales) or [epson.ca](http://epson.ca) (Canadian sales). You can also purchase supplies from an Epson authorized reseller. To find the nearest one, call 800-GO-EPSON (800-463-7766) in the U.S. or 800-807-7766 in Canada.

Paper Type	Size	Part number	Sheet count
Epson Bright White Paper	Letter (8.5 × 11 inches [216 × 279 mm])	S041586	500
Epson Photo Paper Glossy	4 × 6 inches (102 × 152 mm)	S041809	50
		S042038	100
	Letter (8.5 × 11 inches [216 × 279 mm])	S041141	20
		S041649	50
11 × 17 inches (279 × 432 mm)	S041271	100	
	S041156	20	

<b>Paper Type</b>	<b>Size</b>	<b>Part number</b>	<b>Sheet count</b>
Epson Premium Photo Paper Glossy	4 × 6 inches (102 × 152 mm)	S041808	40
		S041727	100
	5 × 7 inches (127 × 178 mm)	S041464	20
	8 × 10 inches (203 × 254 mm)	S041465	20
	Letter (8.5 × 11 inches [216 × 279 mm])	S042183	25
		S041667	50
	11 × 17 inches (279 × 432 mm)	S041290	20
	A3 (11.7 × 16.5 inches [297 × 420 mm])	S041288	20
Epson Ultra Premium Photo Paper Glossy	4 × 6 inches (102 × 152 mm)	S042181	60
		S042174	100
	5 × 7 inches (127 × 178 mm)	S041945	20
	8 × 10 inches (203 × 254 mm)	S041946	20
	Letter (8.5 × 11 inches [216 × 279 mm])	S042182	25
		S042175	50
Epson Ultra Premium Photo Paper Luster	Letter (8.5 × 11 inches [216 × 279 mm])	S041405	50
	A3 (11.7 × 16.5 inches [297 × 420 mm])	S041406	50
Epson Velvet Fine Art Paper	Letter (8.5 × 11 inches [216 × 279 mm])	S041636	20
Epson Premium Photo Paper Semi-gloss	4 × 6 inches (102 × 152 mm)	S041982	40
	Letter (8.5 × 11 inches [216 × 279 mm])	S041331	20

Paper Type	Size	Part number	Sheet count
Epson Presentation Paper Matte	Letter (8.5 × 11 inches [216 × 279 mm])	S041062	100
	Legal (8.5 × 14 inches [216 × 356 mm])	S041067	100
	11 × 17 inches (279 × 432 mm)	S041070	100
Epson Premium Presentation Paper Matte	8 × 10 inches (203 × 254 mm)	S041467	50
	Letter (8.5 × 11 inches [216 × 279 mm])	S041257 S042180	50 100
	A3 (11.7 × 16.5 inches [297 × 420 mm])	S041260	50
Epson Premium Presentation Paper Matte Double-sided	Letter (8.5 × 11 inches [216 × 279 mm])	S041568	50
Epson Ultra Premium Presentation Paper Matte	Letter (8.5 × 11 inches [216 × 279 mm])	S041341	50
	A3 (11.7 × 16.5 inches [297 × 420 mm])	S041343	50
Epson Brochure & Flyer Paper Matte Double-sided	Letter (8.5 × 11 inches [216 × 279 mm])	S042384	150
Epson Photo Quality Self-adhesive Sheets	A4 (8.3 × 11.7 inches [210 × 297 mm])	S041106	10
Epson Iron-on Cool Peel Transfer paper	Letter (8.5 × 11 inches [216 × 279 mm])	S041153	10

Parent topic: [Loading Paper](#)

## Borderless Paper Type Compatibility

You can print borderless photos on compatible paper types in compatible sizes:

### Borderless Paper Types

- Epson Photo Paper Glossy

- Epson Premium Photo Paper Glossy
- Epson Ultra Premium Photo Paper Glossy
- Epson Premium Photo Paper Semi-gloss
- Epson Premium Presentation Paper Matte
- Epson Premium Presentation Paper Matte Double-sided

**Borderless Paper Sizes**

- 4 × 6 inches (102 × 152 mm)
- 5 × 7 inches (127 × 178 mm)
- 8 × 10 inches (203 × 254 mm)
- Letter (8.5 × 11 inches [216 × 279 mm])
- A4 (8.3 × 11.7 inches [210 × 297 mm])

Parent topic: [Loading Paper](#)

**Paper or Media Type Settings - Printer Software**

For this paper	Select this paper Type or Media Type setting
Plain paper Epson Bright White Paper Epson Iron-on Cool Peel Transfer paper Epson Photo Quality Self-adhesive Sheets	Plain Paper/Bright White Paper
Epson Ultra Premium Photo Paper Glossy	Ultra Premium Photo Paper Glossy
Epson Premium Photo Paper Glossy	Premium Photo Paper Glossy
Epson Photo Paper Glossy	Photo Paper Glossy
Epson Presentation Paper Matte	Presentation Paper Matte
Epson Premium Photo Paper Semi-gloss	Premium Photo Paper Semi-Gloss
Epson Ultra Premium Photo Paper Luster	Ultra Premium Photo Paper Luster

For this paper	Select this paper Type or Media Type setting
Epson Premium Presentation Paper Matte Epson Premium Presentation Paper Matte Double-sided Epson Ultra Premium Presentation Paper Matte Epson Brochure & Flyer Paper Matte Double-sided	Premium Presentation Paper Matte
Epson Velvet Fine Art Paper	Velvet Fine Art Paper
Envelopes	Envelope

**Note:** The settings listed here are available only when printing from your computer; they do not apply to your product's control panel settings.

**Parent topic:** [Loading Paper](#)

---

## Placing Originals on the Product

Follow the instructions here to place your original documents or photos on the product.

**Caution:** Do not place anything on top of your product or use its cover as a writing surface to avoid damaging it.

[Placing Originals on the Scanner Glass](#)

**Related topics**

[Copying](#)

[Scanning](#)

## Placing Originals on the Scanner Glass

You can place originals up to this size on the scanner glass: Letter (8.5 × 11 inches [216 × 279 mm]) or A4 (8.3 × 11.7 inches [210 × 297 mm]).

1. Open the document cover.

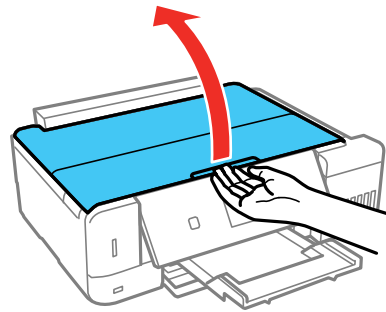

2. Place your original facedown on the scanner glass with the top of the original facing into the corner shown. Slide the original to the edges of the indicated corner.

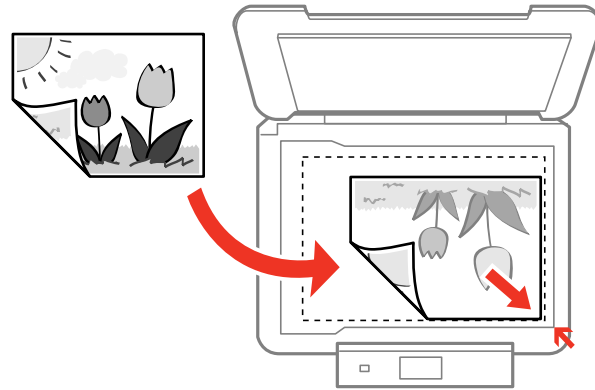

**Note:** You can place multiple originals on the scanner glass. Just make sure they are at least 0.20 inch (5 mm) away from each other and from the edge of the scanner glass.

3. If you are copying two book pages onto one sheet, place the book as shown to copy the first page, then turn the book as shown to copy the second page.

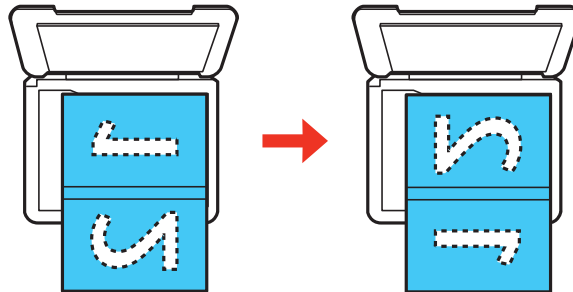

4. Close the document cover gently to keep your original in place.

**Parent topic:** [Placing Originals on the Product](#)

---

## Copying

See the information here to copy documents or photos using your product.

**Note:** Copies may not be exactly the same size as your originals.

[Copying Documents or Photos](#)

[Copying and Restoring Photos](#)

### Copying Documents or Photos

You can copy documents or photos onto various sizes and types of paper, including Epson special papers.

1. Place your original document or photo on the scanner glass.
2. Load the paper you want to print on.

**Note:** Load only the recommended number of sheets.

3. Press the arrow buttons to select **Copy** and press the **OK** button.



4. To print more than one copy, press the **+** or **-** button to select the number (up to 99).
5. Press the right or left arrow button to select **Color** or **B&W**.

6. To view and change additional copy settings, press the down arrow button to select **Settings > Paper and Copy Settings** and press the **OK** button.
7. When you are ready to copy, press the  start button.

**Note:** To cancel copying, press the  cancel button.

[Paper Type Settings - Copying](#)

[Paper Size Settings - Copying](#)

[Copying Options](#)

**Parent topic:** [Copying](#)

**Related references**

[Available Epson Papers](#)

**Related tasks**

[Placing Originals on the Scanner Glass](#)

**Related topics**

[Loading Paper](#)

## Paper Type Settings - Copying

Select a **Paper Type** setting that matches the paper you loaded.

Paper type loaded	Paper Type setting
Plain paper Epson Bright White Paper Epson Iron-on Cool Peel Transfer paper Epson Photo Quality Self-adhesive Sheets	<b>Plain Paper</b>
Epson Presentation Paper Matte	<b>Presentation Matte</b>
Epson Premium Presentation Paper Matte Epson Premium Presentation Paper Matte Double-sided Epson Ultra Premium Presentation Paper Matte	<b>Prem. Matte</b>
Epson Premium Photo Paper Glossy Epson Ultra Premium Photo Paper Luster	<b>Prem. Glossy</b>

Paper type loaded	Paper Type setting
Epson Ultra Premium Photo Paper Glossy	Ultra Glossy
Epson Photo Paper Glossy	Glossy
Epson Premium Photo Paper Semi-gloss	Prem. Semi-Gloss
Epson Velvet Fine Art Paper	Velvet Fine Art Paper

Parent topic: [Copying Documents or Photos](#)

## Paper Size Settings - Copying

Select the **Paper Size** setting that matches the paper you loaded.

**Note:** You can copy only on these paper sizes.

- 4 × 6 inches (102 × 152 mm)
- 5 × 7 inches (127 × 178 mm)
- 8 × 10 inches (203 × 254 mm)
- A4 (8.3 × 11.7 inches [210 × 297 mm])
- Letter (8.5 × 11 inches [216 × 279 mm])
- 11 × 17 inches (279 × 432 mm)
- A3 (11.7 × 16.5 inches [297 × 420 mm])

Parent topic: [Copying Documents or Photos](#)

## Copying Options

Select the copying options you want to use for your copies.

**Note:** Not all options or settings may be available, depending on other copying settings.

Copying option	Available settings	Description
Density	Varying levels	Adjusts the lightness or darkness of copies

<b>Copying option</b>	<b>Available settings</b>	<b>Description</b>
<b>Remove Background</b>	<b>Off</b>	Removes or lightens the background color (may not remove very dark or vivid colors)
	<b>On</b>	
<b>2-Sided Copying</b>	<b>1&gt;1-Sided</b>	Uses the duplexer to make 2-sided copies
	<b>1&gt;2-Sided</b>	
<b>Layout</b>	<b>With Border</b>	Leaves a small margin around the image
	<b>Borderless</b>	Expands the image to the edge of the paper (slight cropping may occur)
	<b>A4, 2-up Copy</b>	Copies 2 originals onto a single A4-size sheet
	<b>Letter, 2-up Copy</b>	Copies 2 originals onto a single letter-size sheet
	<b>A4, Book/2-up</b>	Copies 2 pages of a book or magazine onto a single A4-size sheet
	<b>Letter, Book/2-up</b>	Copies 2 pages of a book or magazine onto a single letter-size sheet
<b>Reduce/Enlarge</b>	<b>Custom Size</b>	Automatically sizes the image by the percentage you select
	<b>Actual Size</b>	Copies at 100% size
	<b>Auto Fit Page</b>	Automatically sizes the image to fit the selected paper size setting
	<b>Letter-&gt;4x6in</b> and other conversions	Automatically converts from one size to another
<b>Paper Size</b>	Various sizes	Selects the paper size for the copy printout
<b>Paper Type</b>	Various types	Adjusts printer settings for the selected paper type

Copying option	Available settings	Description
<b>Paper Source</b>	<b>Cassette 1</b>	Copies onto paper loaded in Cassette 1 (upper cassette)
	<b>Cassette 2</b>	Copies onto paper loaded in Cassette 2 (lower cassette)
	<b>Rear Paper Feed Slot</b>	Copies onto paper loaded in the rear paper feed slot (only one sheet at a time)
<b>Document Type</b>	<b>Text</b>	Copies a text document
	<b>Text &amp; Image</b>	Copies a document that includes text and images
	<b>Photo</b>	Copies a photograph
<b>Quality</b>	<b>Draft</b>	Provides lower quality for draft copies (plain paper only)
	<b>Standard</b>	Provides good quality for most copies
	<b>Best</b>	Provides the highest quality for special copies
<b>Document Orientation</b>	<b>Portrait</b>	Specifies the orientation of your originals (available only when <b>1&gt;2-Sided</b> is selected)
	<b>Landscape</b>	
<b>Binding Margin</b>	<b>Left Edge</b>	Specifies the binding edge of your double-sided copies (available only when <b>1&gt;2-Sided</b> is selected)
	<b>Top Edge</b>	
<b>Expansion</b>	<b>Standard</b>	Adjusts the amount of expansion for printing borderless photos (available only when <b>Borderless</b> is selected)
	<b>Medium</b>	
	<b>Minimum</b>	
<b>Dry Time</b>	<b>Standard</b>	Provides longer drying time for 2-sided copies, if smudges or marks appear on the front of the paper when you print on the second side
	<b>Long</b>	
	<b>Longer</b>	

Parent topic: [Copying Documents or Photos](#)

### Related references

[Paper Type Settings - Copying](#)

[Paper Size Settings - Copying](#)

## Copying and Restoring Photos

You can restore the colors in faded photos as you copy them.

1. Load photo paper in the product.
2. Press the  home button, if necessary.
3. Press the arrow buttons to select **More Functions** and press the **OK** button.
4. Select **Copy/Restore Photos** and press the **OK** button.

You see this screen:



5. Select **On** and press the **OK** button.
6. Place up to two original photos on the product.

**Note:** Press the up or down arrow buttons for instructions on placing your photos on the product.

7. Press the  start button.
8. Press the **+** or **-** button to select one or more copies of the photo (up to 99).
9. If you placed two originals on the scanner, press the left or right arrow button to view the second original, then press **+** or **-** button to select one or more copies of the photo (up to 99).

10. To select settings for the photos, press the down arrow button.
11. Do one or more of the following:
  - To change the display setting for the LCD screen, select **Display Mode**, press the **OK** button, and select the setting you want.
  - To change the print settings, select **Paper and Copy Settings**, press the **OK** button, and select the necessary settings.
  - To adjust the copy image, select **Photo Adjustments**, press the **OK** button, and select the necessary settings.
  - To add a black-and-white filter, select **Filter**, press the **OK** button, and select **B&W**.
  - To crop or zoom into your photo, select **Crop/Zoom**, press the **OK** button, and press the **+** or **-** and arrow buttons to adjust the image area.
12. When you are ready to print, press the  start button.

**Note:** To cancel copying, press the  cancel button.

**Parent topic:** [Copying](#)

**Related references**

[Paper Type Settings - Copying](#)

[Paper Size Settings - Copying](#)

[Copying Options](#)

**Related tasks**

[Placing Originals on the Scanner Glass](#)

**Related topics**

[Loading Paper](#)

---

# Printing from a Computer

Before printing from your computer, make sure you have set up your product and installed its software as described on the *Start Here* sheet.

**Note:** If you have an Internet connection, it is a good idea to check for updates to your product software on Epson's support website. If you see a Software Update screen, select **Enable automatic checking** and click **OK**. The update scans your system to see if you have the latest product software. Follow the on-screen instructions.

[Printing with Windows](#)

[Printing with the Built-in Epson Driver - Windows 10 S](#)

[Printing on a Mac](#)

[Cancelling Printing Using a Product Button](#)

## Printing with Windows

You can print with your product using any Windows application, as described in these sections.

**Note:** If you are using your Epson product with the Windows 10 S operating system, you cannot use the software described in this section. You also cannot download and install any Epson product software from the Epson website for use with Windows 10 S; you must obtain software only from the Windows Store.

[Selecting Basic Print Settings - Windows](#)

[Selecting Double-sided Printing Settings - Windows](#)

[Selecting Additional Layout and Print Options - Windows](#)

[Selecting a Printing Preset - Windows](#)

[Selecting Extended Settings - Windows](#)

[Printing Your Document or Photo - Windows](#)

[Selecting Default Print Settings - Windows](#)

[Changing Automatic Update Options](#)

**Parent topic:** [Printing from a Computer](#)

## Selecting Basic Print Settings - Windows

Select the basic settings for the document or photo you want to print.

1. Open a photo or document for printing.
2. Select the print command in your application.

**Note:** You may need to select a print icon on your screen, the **Print** option in the **File** menu, or another command. See your application's help utility for details.

3. If necessary, select your product name as the printer you want to use.

**Note:** You may also need to select **Properties** or **Preferences** to view your print settings.

You see the Main tab of your printer settings window:

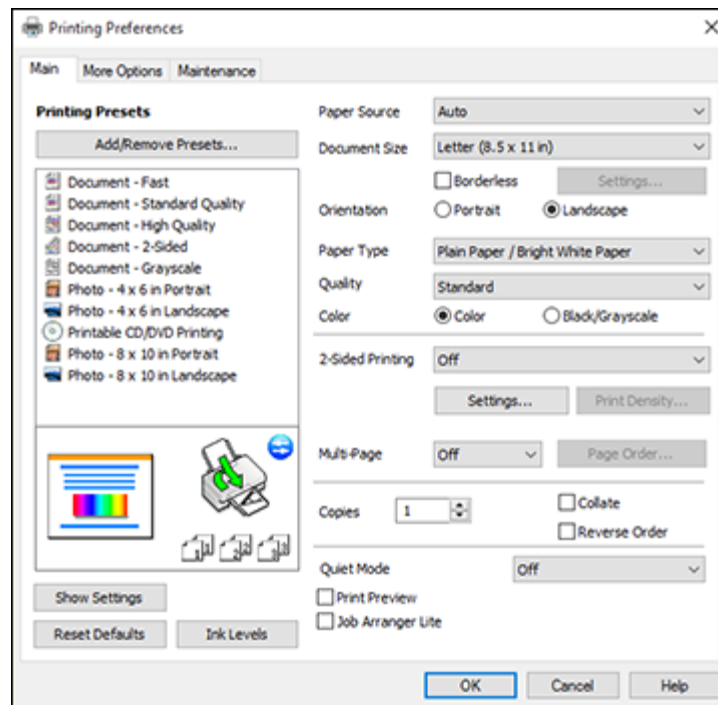

4. For the **Paper Source** setting, select where you loaded the paper you want to print on.

5. Select the size of the paper you loaded as the **Document Size** setting.

**Note:** You can also select the **User-Defined** setting to create a custom paper size, but you cannot use the **Borderless** setting.

6. If you are printing a borderless photo, select **Borderless**. You can click **Settings** to access additional options for borderless printing.

**Note:** You must select a compatible borderless paper type and size to print without borders. Check the borderless paper compatibility list for details.

7. Select the orientation of your document.

**Note:** If you are printing an envelope, select **Landscape**.

8. Select the type of paper you loaded as the **Paper Type** setting.

**Note:** The setting may not exactly match the name of your paper. Check the paper type settings list for details.

9. Select the **Quality** setting that matches the print quality you want to use.

10. Select a Color option:

- To print a color document or photo, select the **Color** setting.
- To print text and graphics in black or shades of gray, select the **Black/Grayscale** setting.

11. To print on both sides of the paper, select a **2-Sided Printing** option.

12. To print multiple pages on one sheet of paper, or print one image on multiple sheets of paper, select one of the settings in the **Multi-Page** menu and select the printing options you want.

13. To print multiple copies and arrange their print order, select the **Copies** options.

14. To reduce noise during printing when you select **Plain Paper/Bright White Paper**, turn on **Quiet Mode** (printing will be slower).

15. To preview your job before printing, select **Print Preview**.

16. To save your print job as a project that can be modified and combined with other print jobs, select **Job Arranger Lite**.

[Paper Source Options - Windows](#)

[Print Quality Options - Windows](#)

[Multi-Page Printing Options - Windows](#)

**Parent topic:** [Printing with Windows](#)

**Related references**

[Paper or Media Type Settings - Printer Software](#)

[Borderless Paper Type Compatibility](#)

**Related tasks**

[Selecting Double-sided Printing Settings - Windows](#)

[Printing Your Document or Photo - Windows](#)

**Paper Source Options - Windows**

You can select any of the available options in the Paper Source menu to print on the paper loaded in that source.

**Auto**

Automatically selects the paper source based on the selected paper size.

**Cassette 1**

Selects the paper in cassette 1 as the paper source.

**Cassette 2**

Selects the paper in cassette 2 as the paper source.

**Cassette 1 > Cassette 2**

Selects the paper in cassette 1 as the paper source and automatically switches to cassette 2 when cassette 1 is empty.

**Rear Paper Feed Slot**

Selects the paper in the rear feed slot as the paper source.

**CD/DVD Tray**

Selects the CD or DVD loaded in the CD/DVD tray.

**Parent topic:** [Selecting Basic Print Settings - Windows](#)

**Print Quality Options - Windows**

You can select any of the available Quality options to fine-tune the quality of your print. Some settings may be unavailable, depending on the paper type and border setting you have chosen.

**Draft**

For draft printing on plain paper.

**Standard**

For everyday text and image printing.

## High

For photos and graphics with high print quality.

## More Settings

Opens a window that lets you choose among levels of speed and quality.

Parent topic: [Selecting Basic Print Settings - Windows](#)

## Multi-Page Printing Options - Windows

You can select any of the available options in the Multi-Page menu to set up your multi-page print job.

### 2-Up and 4-Up

Prints 2 or 4 pages on one sheet of paper. Click the **Page Order** button to select page layout and border options.

### 2×1 Poster, 2×2 Poster, 3×3 Poster, 4×4 Poster

Prints one image on multiple sheets of paper to create a larger poster. Click the **Settings** button to select image layout and guideline options.

Parent topic: [Selecting Basic Print Settings - Windows](#)

## Selecting Double-sided Printing Settings - Windows

You can print on both sides of the paper by selecting one of the **2-Sided Printing** options on the Main tab.

**Note:** Some options may be pre-selected or unavailable, depending on other settings you have chosen or if you are accessing the product over a network.

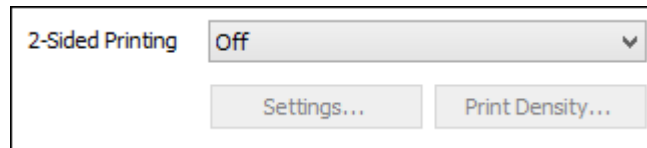

1. Select one of the following options for **2-Sided Printing**:
  - **Auto (Long-edge binding)** to print your double-sided print job by automatically flipping the paper on the long edge.
  - **Auto (Short-edge binding)** to print your double-sided print job by automatically flipping the paper on the short edge.
2. Click the **Settings** button.

You see this window:

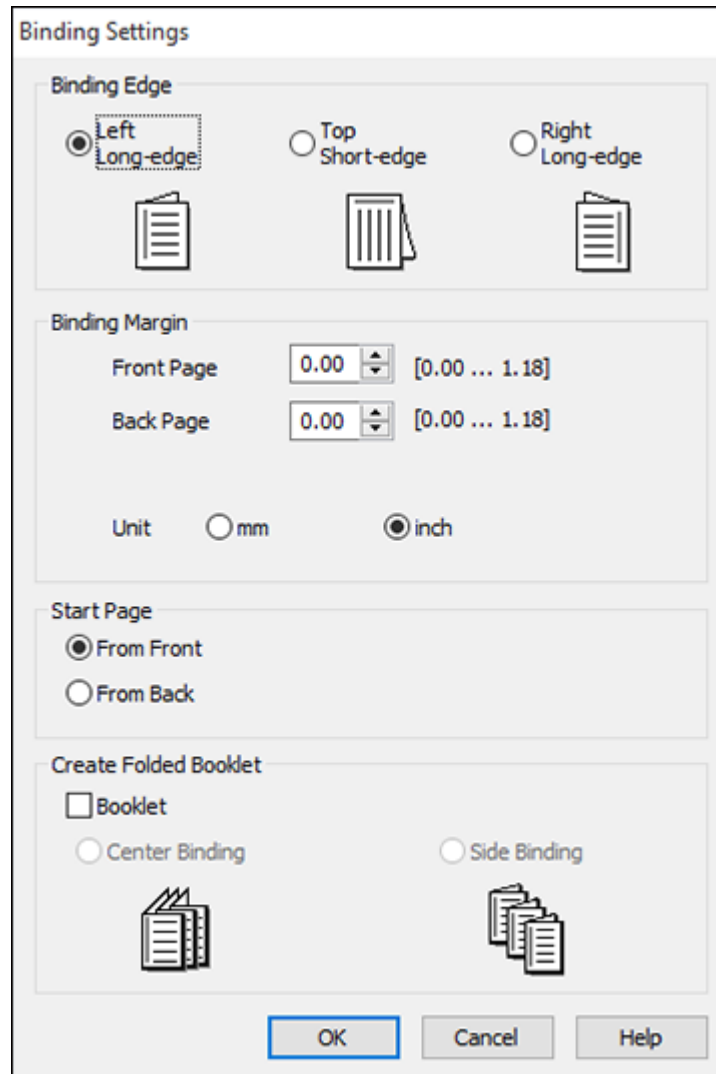

3. Select the double-sided printing options you want to use.
4. Click **OK** to return to the Main tab.

5. Click the **Print Density** button.

You see this window:

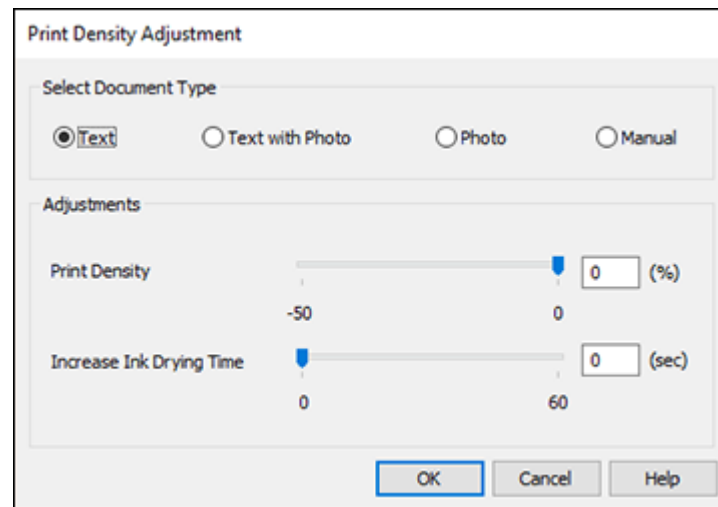

6. Select the type of document you are printing as the Document Type setting. The software automatically sets the **Adjustments** options for that document type.
7. If necessary, select the **Adjustments** options you want to use.
8. Click **OK** to return to the Main tab.
9. Print a test copy of your double-sided document to test the selected settings.
10. Follow any instructions displayed on the screen during printing.

[Double-sided Printing Options - Windows](#)

[Print Density Adjustments - Windows](#)

**Parent topic:** [Printing with Windows](#)

#### **Related tasks**

[Selecting Basic Print Settings - Windows](#)

#### **Double-sided Printing Options - Windows**

You can select any of the available options on the Binding Settings window to set up your double-sided print job.

**Binding Edge Options**

Select a setting that orients double-sided print binding in the desired direction.

**Binding Margin Options**

Select options that define a wider margin to allow for binding.

**Start Page**

Selects whether printing starts on the front or back page.

**Create Folded Booklet Options**

Select the **Booklet** checkbox and a binding option to print double-sided pages as a booklet.

**Parent topic:** [Selecting Double-sided Printing Settings - Windows](#)

**Print Density Adjustments - Windows**

You can select any of the available options on the Print Density Adjustment window to adjust the print quality of your double-sided print job.

**Print Density**

Sets the level of ink coverage for double-sided printing.

**Increase Ink Drying Time**

Sets the amount of time required for drying ink after printing on one side of the paper before printing the other side in double-sided printing to prevent ink smearing.

**Parent topic:** [Selecting Double-sided Printing Settings - Windows](#)

## Selecting Additional Layout and Print Options - Windows

You can select a variety of additional layout and printing options for your document or photo on the More Options tab.

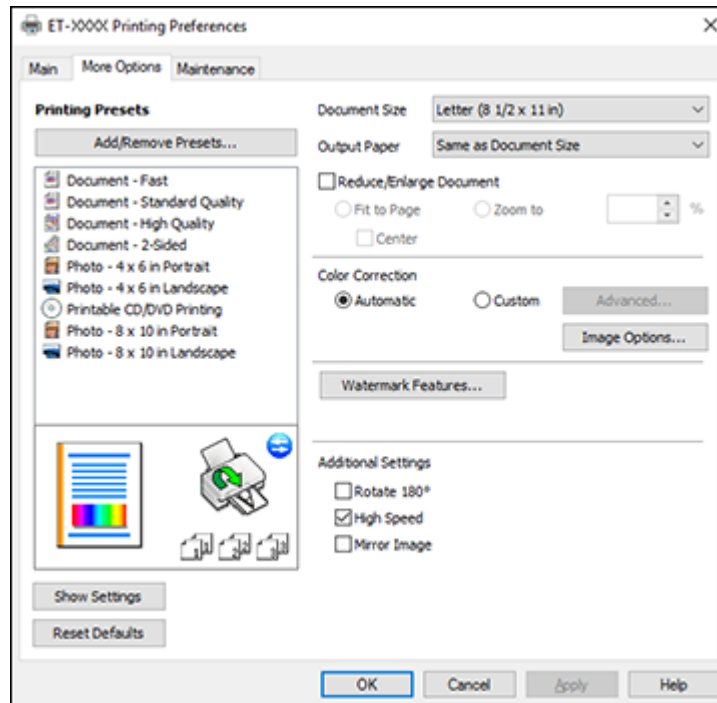

1. To change the size of your printed document or photo, select the **Reduce/Enlarge Document** checkbox and select one of these sizing options:
  - Select the **Fit to Page** option to size your image to fit the paper you loaded. Select the size of your document or photo as the **Document Size** setting, and the size of your paper as the **Output Paper** setting. If you want to center your image on the paper, select the **Center** option.
  - Select the **Zoom to** option to reduce or enlarge your document or photo by a specific percentage. Select the percentage in the % menu.
2. Select one of the following Color Correction options:
  - Select **Automatic** to automatically adjust the sharpness, brightness, contrast, and color saturation for your image.

- Select **Custom** and click the **Advanced** button to manually adjust the color correction settings or turn off color management in your printer software.
- Select **Image Options** to access additional settings for improving printed images.

**Note:** You can also select **Color Universal Print** settings.

3. To add the following features, click the **Watermark Features** button:

- **Watermark:** adds a visible watermark to your printout
- **Header/Footer:** adds information such as the date and time to the top or bottom of your printout

**Note:** Click the **Settings** button to customize the text and location of the header or footer.

4. Select any of the Additional Settings options to customize your print.

[Custom Color Correction Options - Windows](#)

[Image Options and Additional Settings - Windows](#)

[Header/Footer Settings - Windows](#)

**Parent topic:** [Printing with Windows](#)

## Custom Color Correction Options - Windows

You can select any of the available options in the Color Correction window to customize the image colors for your print job.

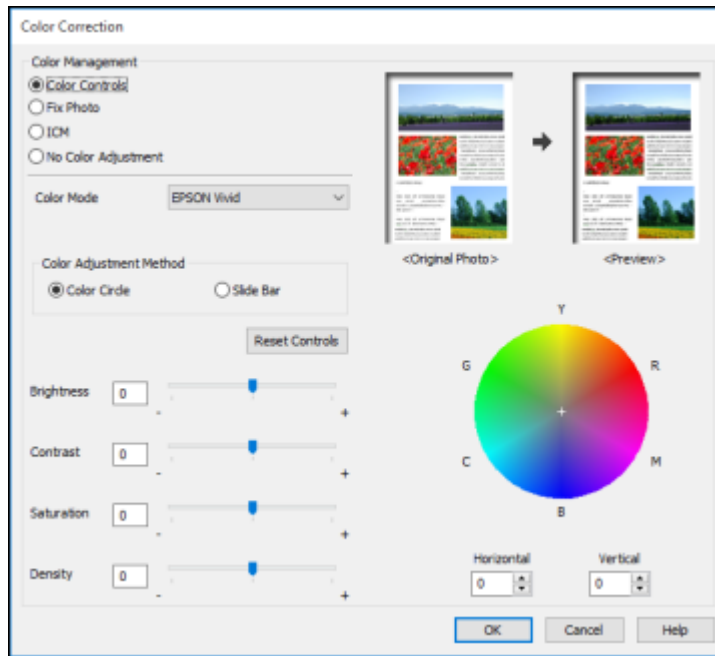

### Color Controls

Lets you select a **Color Mode** setting, individual settings for **Brightness**, **Contrast**, **Saturation**, and **Density**, and individual color tones. Depending on the selected color mode, you can also adjust the midtone density using the **Gamma** setting.

### Fix Photo

Improves the color, contrast, and sharpness of flawed photos.

**Note:** Fix Photo uses a sophisticated face recognition technology to optimize photos that include faces. For this to work, both eyes and the nose must be visible in the subject's face. If your photo includes a face with an intentional color cast, such as a statue, you may want to turn off **Fix Photo** to retain the special color effects.

**ICM**

Lets you manage color using installed color printing profiles.

**No Color Adjustment**

Turns off color management in your printer software so you can manage color using only your application software.

**Parent topic:** [Selecting Additional Layout and Print Options - Windows](#)

**Image Options and Additional Settings - Windows**

You can select any of the Image Options and Additional Settings to customize your print. Some options may be pre-selected or unavailable, depending on other settings you have chosen.

**Image Options****Emphasize Text**

Adjusts the weight of printed text to increase readability.

**Emphasize Thin Lines**

Adjusts the weight of printed lines to increase visibility.

**Edge Smoothing**

Smooths jagged edges in low-resolution images such as screen captures or images from the Web.

**Fix Red-Eye**

Reduces or removes red-eye in photos.

**Print Text in Black**

Prints colored text in black.

**For Color Text**

Prints colored text on a background pattern or underlined.

**For Color Graphs and Images**

Prints colored graphics and images with overlay patterns.

**For Color Text, Graphs, and Images**

Prints colored text, graphics, and images with overlay patterns.

**Enhancement Options**

Specifies Color Universal Print enhancement settings for text, graphics, and images.

**Additional Settings Options****Rotate 180°**

Prints the image rotated 180° from its original orientation.

**High Speed**

Speeds up printing but may reduce print quality.

**Mirror Image**

Flips the printed image left to right.

**Parent topic:** [Selecting Additional Layout and Print Options - Windows](#)

**Header/Footer Settings - Windows**

You can select any of the Header/Footer Settings options to add headers or footers when you print. The items are available to print at the top or bottom of your pages, in either the left, right, or center of the page.

**Note:** These settings are not saved with your document.

Top Left	Top Center	Top Right
User Name	None	Date/Time
Bottom Left	Bottom Center	Bottom Right
None	None	None

Reset Defaults OK Cancel Help

You can select to print the following information:

- User Name
- Computer Name
- Date
- Date/Time
- Collate Number (copy number)

**Note:** The user name, computer name, date, and time come from the Windows Control Panel on your computer.

**Parent topic:** [Selecting Additional Layout and Print Options - Windows](#)

## Selecting a Printing Preset - Windows

For quick access to common groups of print settings, you can select a printing preset on the Main or More Options tab.

**Note:** You can create your own preset by clicking the **Add/Remove Presets** button.

1. Click the **Main** or **More Options** tab.

You see the available **Printing Presets** on the left:

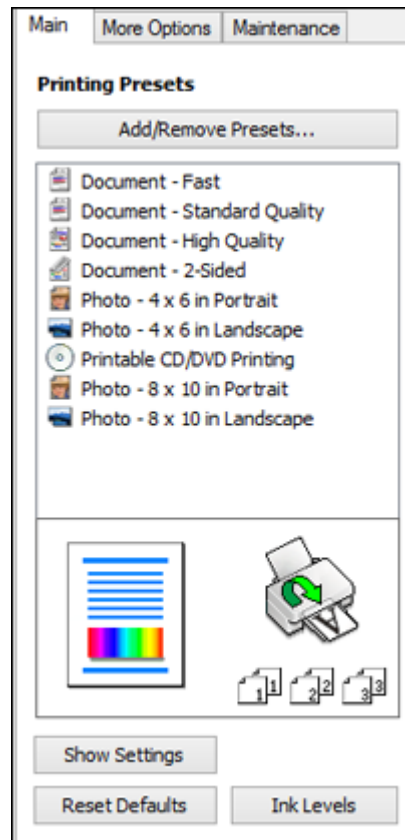



2. Place your cursor over one of the **Printing Presets** to view its list of settings.

3. Click on a preset to change its settings, or use any of the available options on the screen to control your printing presets.
4. To choose a preset for printing, select it.
5. Click **OK**.

**Parent topic:** [Printing with Windows](#)

## Selecting Extended Settings - Windows

You can select additional settings that apply to all the print jobs you send to your product.

1. Access the Windows Desktop and right-click the  icon for your product in the right side of the Windows taskbar, or click the up arrow and right-click .
2. Select **Printer Settings**.
3. Click the **Maintenance** tab.

You see the maintenance options:

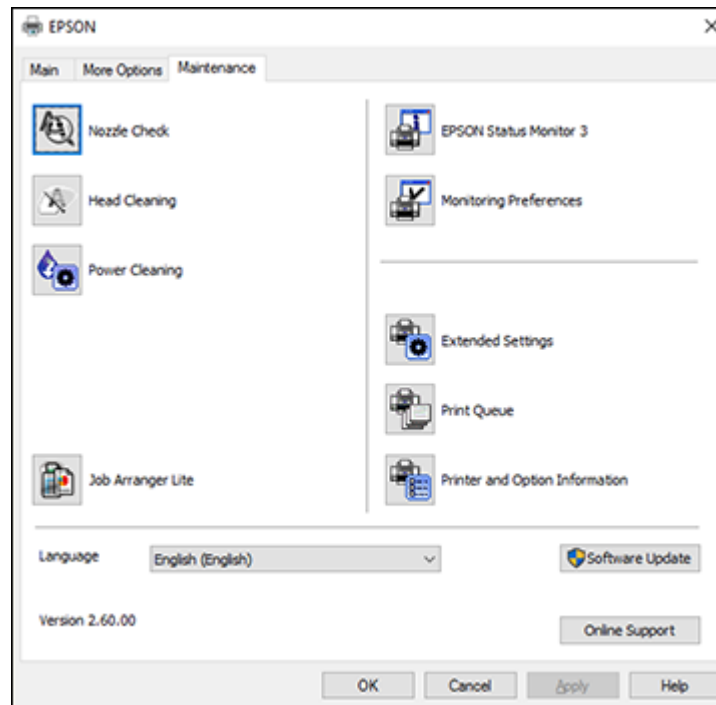

4. Click the **Extended Settings** button.

You see this window:

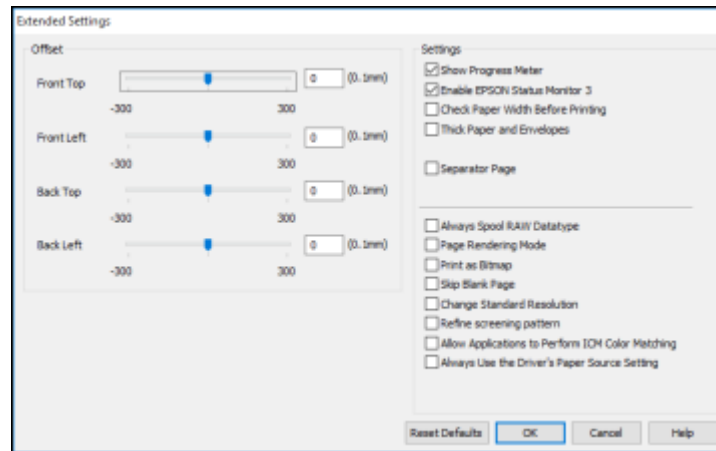

5. Select any of the extended settings to customize your print.
6. Click **OK** to close the Extended Settings window.
7. Click **OK** to close the printer software window.

### [Extended Settings - Windows](#)

**Parent topic:** [Printing with Windows](#)

### **Extended Settings - Windows**

You can select from these settings on the Extended Settings window.

#### **Show Progress Meter**

Displays the progress of print jobs as they are being printed.

#### **Enable EPSON Status Monitor 3**

Enables product monitoring for ink and paper supplies and other issues.

#### **Check Paper Width Before Printing**

Prevents printing beyond the edges of the paper if the paper size setting is incorrect; may reduce print speed.

#### **Thick Paper and Envelopes**

Prevents ink from smearing when you print on envelopes or other thick paper.

**Separator Page**

Before each document, prints a separator page containing the title, user, date, and time.

**Always Spool RAW Datatype**

Increases print speed and may solve other printing problems.

**Page Rendering Mode**

Increases print speed when printing is extremely slow or the print head stops during printing.

**Print as Bitmap**

Increases print speed when printing is extremely slow or the print head stops during printing, and other settings do not help.

**Skip Blank Page**

Ensures that your product does not print pages that contain no text or images.

**Change Standard Resolution**

Reduces the resolution of print data to correct printing problems.

**Refine screening pattern**

Prints graphics with a finer screening pattern.

**Allow Applications to Perform ICM Color Matching**

Allows applications to perform ICM color matching.

**Always Use the Driver's Paper Source Setting**

Prints using the paper source setting in the printer driver, rather than the setting in your application.

Parent topic: [Selecting Extended Settings - Windows](#)

## Printing Your Document or Photo - Windows

Once you have selected your print settings, you are ready to save your settings and print.

1. Click **OK** to save your settings.

You see your application's Print window, such as this one:

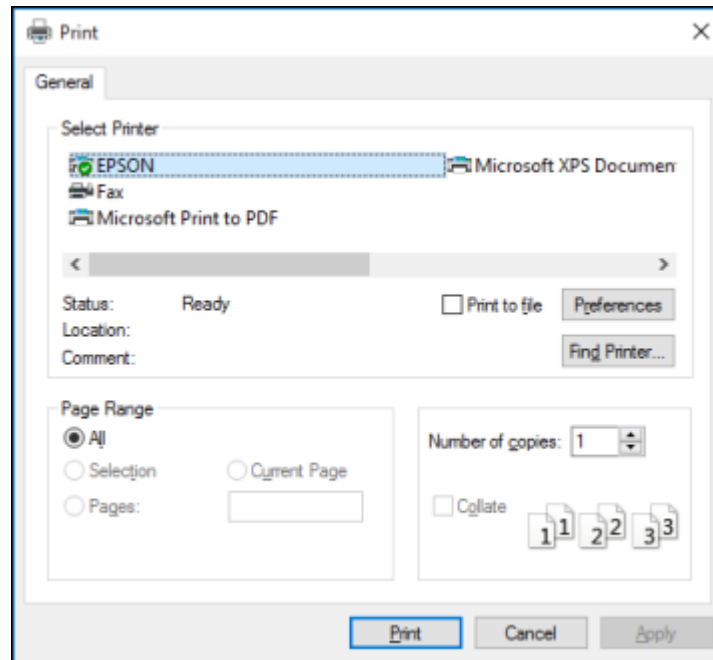

2. Click **OK** or **Print** to start printing.

[Checking Print Status - Windows](#)

**Parent topic:** [Printing with Windows](#)

## Checking Print Status - Windows

During printing, you see this window showing the progress of your print job. It allows you to control printing and check ink status.

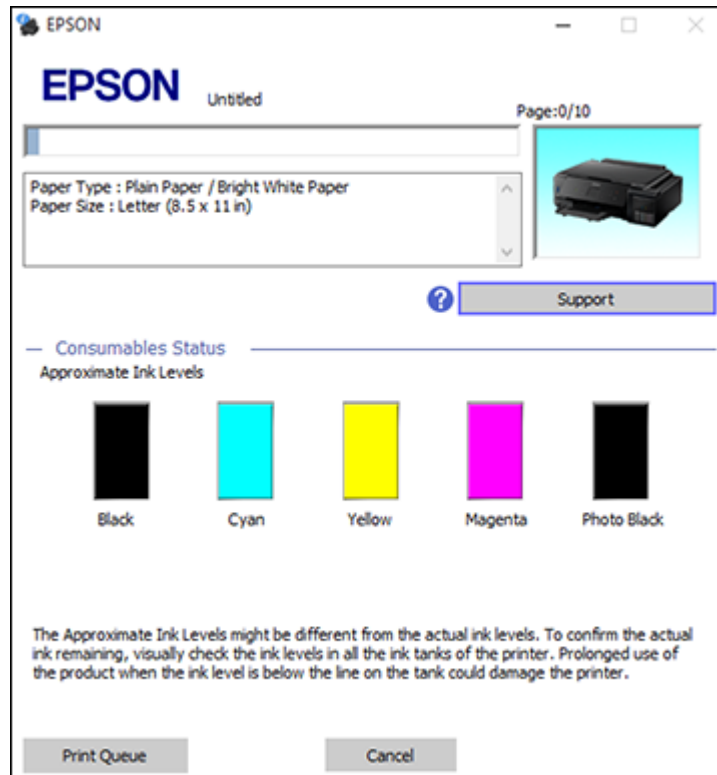



- To cancel printing, click **Cancel**.
- To see print jobs lined up for printing, click **Print Queue**.

**Parent topic:** [Printing Your Document or Photo - Windows](#)

## Selecting Default Print Settings - Windows

When you change your print settings in a program, the changes apply only while you are printing in that program session. If you want to change the print settings you use in all your Windows programs, you can select new default print settings.

1. Access the Windows Desktop and right-click the  icon for your product in the right side of the Windows taskbar, or click the up arrow and right-click .
2. Select **Printer Settings**.

You see the printer settings window:

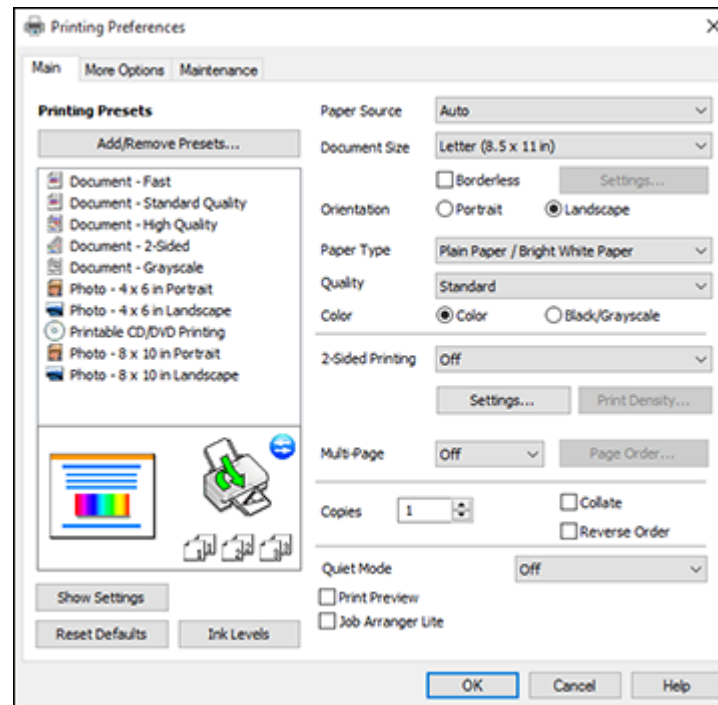

3. Select the print settings you want to use as defaults in all your Windows programs.
4. Click **OK**.



These settings are now the defaults selected for printing. You can still change them as needed for printing in any program session.

[Changing the Language of the Printer Software Screens](#)

**Parent topic:** [Printing with Windows](#)

## Changing the Language of the Printer Software Screens

You can change the language used on the Windows printer software screens.

1. Access the Windows Desktop and right-click the  icon for your product in the right side of the Windows taskbar, or click the up arrow and right-click .
2. Select **Printer Settings**.  
You see the printer settings window.
3. Click the **Maintenance** tab.  
You see the maintenance options:

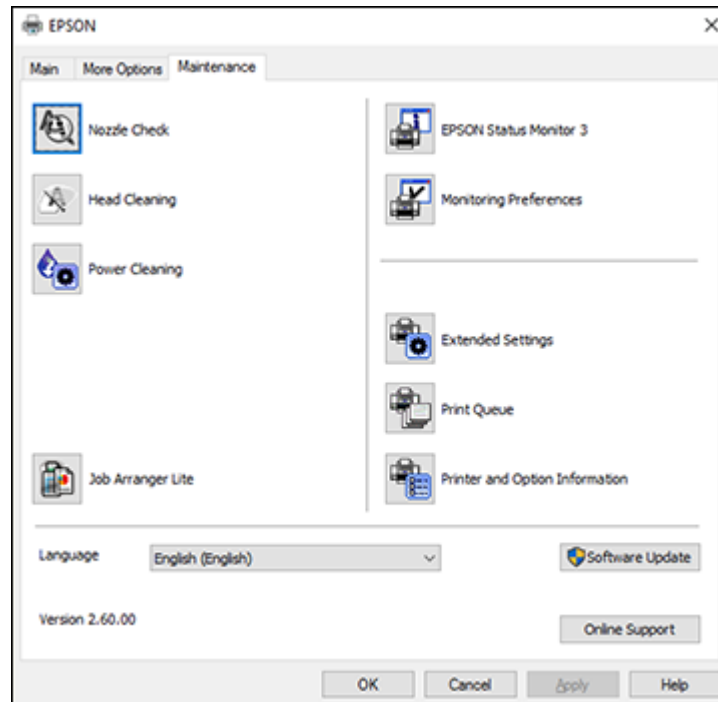



4. Select the language you want to use as the **Language** setting.
5. Click **OK** to close the printer software window.

The printer software screens appear in the language you selected the next time you access them.

**Parent topic:** [Selecting Default Print Settings - Windows](#)

## Changing Automatic Update Options

Your printer software for Windows automatically checks for updates to the product software. You can change how often the software checks for updates or disable this feature.

1. Access the Windows Desktop and right-click the  icon for your product in the right side of the Windows taskbar, or click the up arrow and right-click .
2. Select **Software Update Settings**.

You see this window:

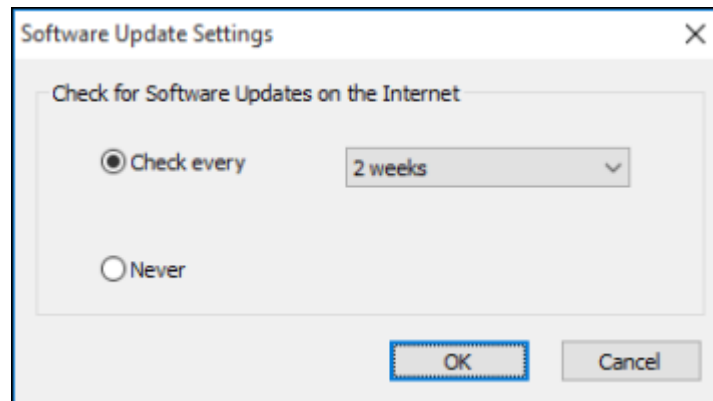

3. Do one of the following:
  - To change how often the software checks for updates, select a setting in the **Check every** menu.
  - To disable the automatic update feature, select the **Never** option.
4. Click **OK** to exit.

**Note:** If you choose to disable the automatic update feature, you can check for updates manually.

**Parent topic:** [Printing with Windows](#)

### **Related tasks**

[Checking for Software Updates](#)

## Printing with the Built-in Epson Driver - Windows 10 S

You can print with the built-in Epson printer driver using any printing program on Windows 10 S, as described in these sections.

**Note:** The built-in Epson driver in Windows 10 S does not include all the available print settings for your product. To print with additional settings, download and install the Epson Print and Scan utility from the Windows Store. You cannot download and install any Epson product software from the Epson website for use with Windows 10 S; you must obtain software only from the Windows Store.

[Selecting Print Settings - Windows 10 S](#)

**Parent topic:** [Printing from a Computer](#)

### Selecting Print Settings - Windows 10 S

Select the settings for your print job in your Windows 10 S application.

1. Open a photo or document for printing.
2. Select the print command in your application.

**Note:** You may need to select a print icon on your screen, the **Print** option in the **File** menu, or another command. See your application's help utility for details.

3. If necessary, select your product name as the printer you want to use.

**Note:** You may also need to select **Properties** or **Preferences** to view your print settings.

You see a window like this:

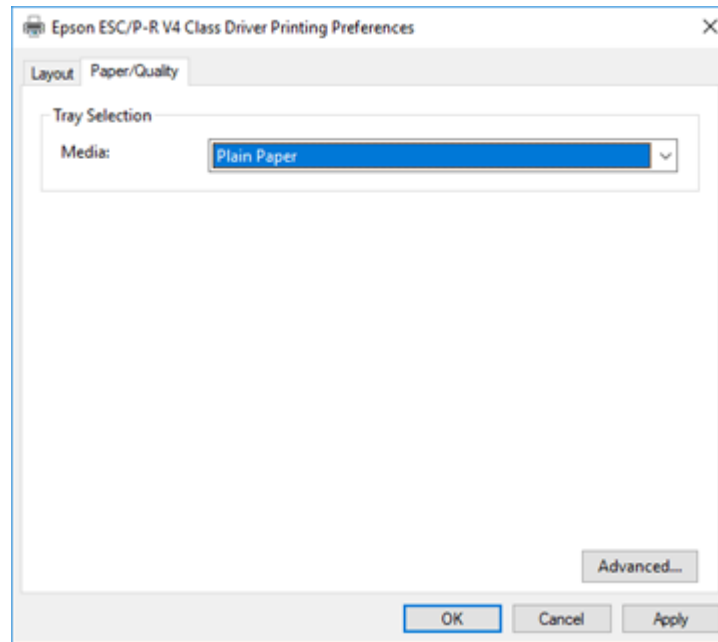

4. Select the type of paper you loaded as the **Media** setting.

**Note:** The setting may not exactly match the name of your paper. Check the paper type settings list for details.

5. Click the **Advanced** button.

You see a window like this:

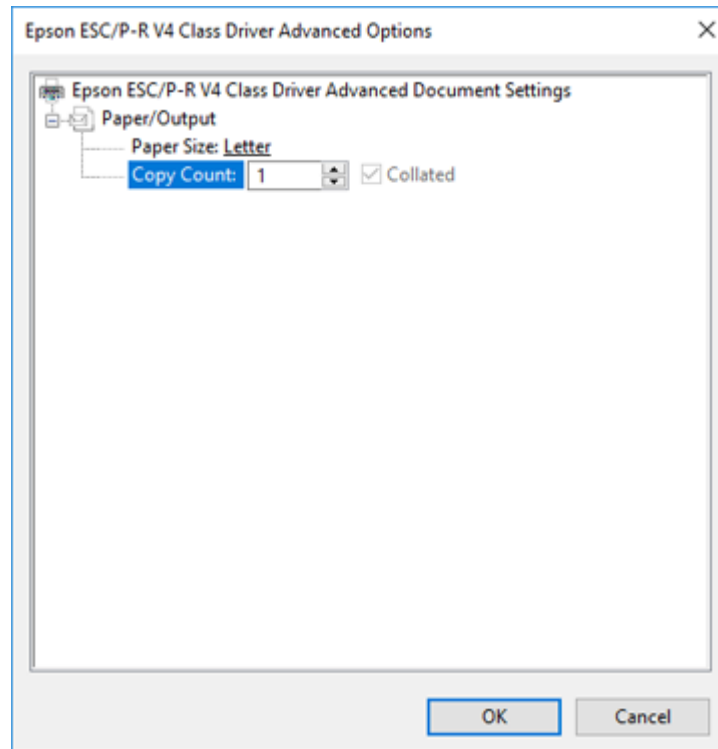

6. Select the size of the paper you loaded as the **Paper Size** setting.
7. To print multiple copies, select or enter the number as the **Copy Count** setting.
8. To print multiple copies of multi-page documents in sets, select the **Collated** checkbox.
9. Click **OK**.

You return to the printing preferences window.

10. Select the **Layout** tab.

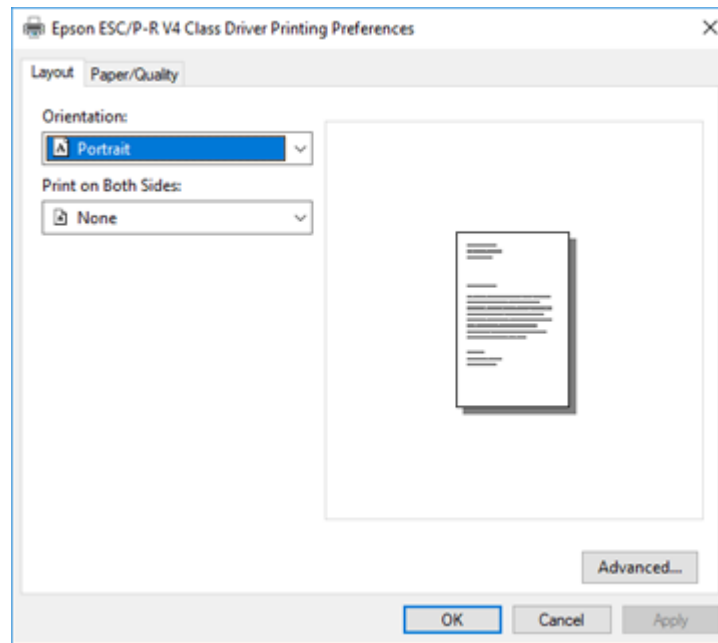

11. Select the orientation of your document as the **Orientation** setting.

- To printing double-sided, select one of the **Print on Both Sides** options, depending on how you want to orient the page layout. The icon next to each option shows the layout.

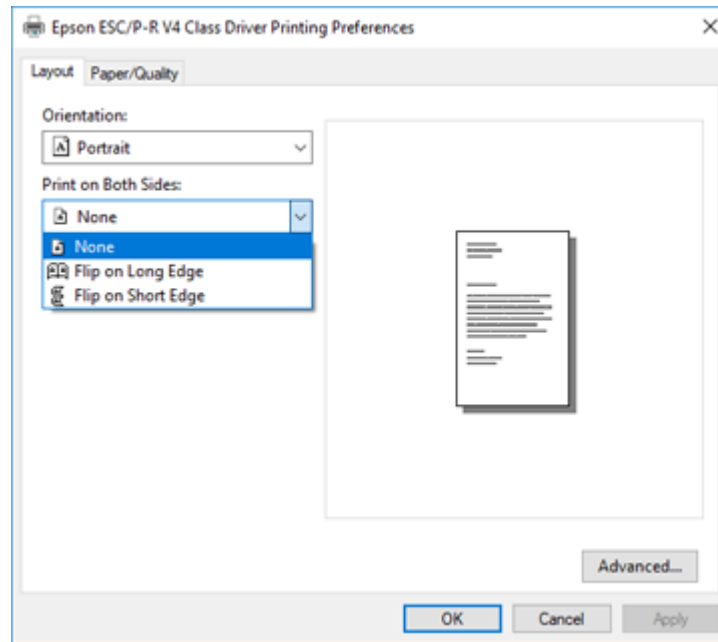

- Click **OK** to save your settings.

You see your application's **Print** window.

- Click **OK** or **Print** to start printing.

**Parent topic:** [Printing with the Built-in Epson Driver - Windows 10 S](#)

## Printing on a Mac

You can print with your product using any Mac printing program, as described in these sections.

**Note:** If you have an Internet connection, it is a good idea to check for updates to your product software on Epson's support website.

[Selecting Basic Print Settings - Mac](#)

[Selecting Page Setup Settings - Mac](#)

- [Selecting Print Layout Options - Mac](#)
  - [Selecting Double-sided Printing Settings - Mac](#)
  - [Managing Color - Mac](#)
  - [Selecting Printing Preferences - Mac](#)
  - [Printing Your Document or Photo - Mac](#)
- Parent topic:** [Printing from a Computer](#)

## Selecting Basic Print Settings - Mac

Select the basic settings for the document or photo you want to print.

1. Open a photo or document for printing.
2. Select the print command in your application.

**Note:** You may need to select a print icon on your screen, the **Print** option in the File menu, or another command. See your application's help utility for details.

3. Select your product as the **Printer** setting.

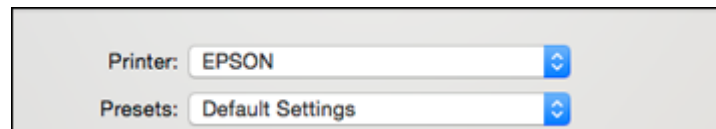

4. If necessary, click the arrow next to the Printer setting or the **Show Details** button to expand the print window.

You see the expanded printer settings window for your product:

The image shows a printer settings dialog box for an EPSON printer. The settings are as follows:

- Printer: EPSON
- Presets: Default Settings
- Copies: 1
- Pages:  All,  From: 1 to: 1
- Paper Size: US Letter (216 by 279 mm)
- Orientation: Portrait (selected), Landscape
- Preview: Preview
- Auto Rotate:  Show Notes:
- Scale:  100 %  Scale to Fit
- Print Entire Image:  Fill Entire Paper:
- Copies per page: 1

Buttons: Cancel, Print

**Note:** The print window may look different, depending on your version of the Mac operating system and the application you are using.

5. Select the **Copies** and **Pages** settings as necessary.

**Note:** If you do not see these settings in the print window, check for them in your application before printing.

6. Select the page setup options: **Paper Size** and **Orientation**.

**Note:** If you do not see these settings in the print window, check for them in your application before printing. They may be accessible by selecting **Page Setup** from the File menu.

7. Select any application-specific settings that appear on the screen, such as those shown in the image above for the Preview application.
8. Select **Print Settings** from the pop-up menu.

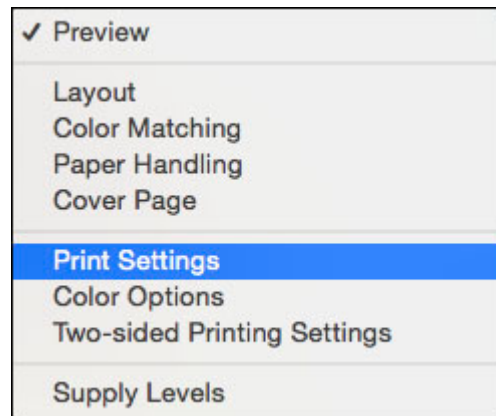

You see these settings:

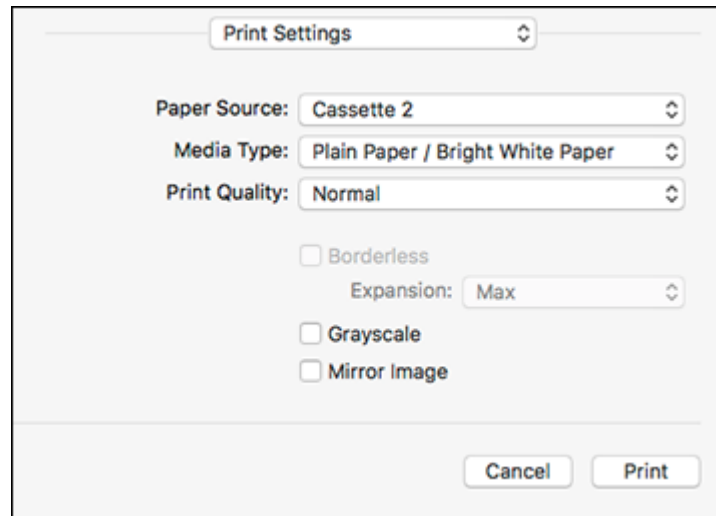

9. Select the **Paper Source** you wish to print from.
10. Select the type of paper you loaded as the **Media Type** setting.

**Note:** The setting may not exactly match the name of your paper. Check the paper type settings list for details.

11. Select the **Print Quality** setting you want to use.
12. Select any of the available print options.

[Paper Source Options - Mac](#)

[Print Quality Settings - Mac](#)

[Print Options - Mac](#)

**Parent topic:** [Printing on a Mac](#)

#### **Related references**

[Paper or Media Type Settings - Printer Software](#)

#### **Related tasks**

[Selecting Page Setup Settings - Mac](#)

## [Printing Your Document or Photo - Mac](#)

### **Paper Source Options - Mac**

You can select any of the available options in the Paper Source menu to print from paper loaded in that source.

#### **Auto Select**

Automatically selects the paper source based on the selected paper size.

#### **Cassette 1**

Selects the paper in cassette 1 as the paper source.

#### **Cassette 2**

Selects the paper in cassette 2 as the paper source.

#### **Rear Paper Feed Slot**

Selects the paper in the rear feed slot as the paper source.

**Parent topic:** [Selecting Basic Print Settings - Mac](#)

### **Print Quality Settings - Mac**

You can select any of the **Print Quality** settings to fine-tune the quality of your print. Some settings may be unavailable, depending on the paper type and border setting you have chosen.

#### **Draft**

For draft printing on photo paper.

#### **Fast Economy**

For the fastest printing with draft quality.

#### **Economy**

For fast printing with reduced quality.

#### **Normal**

For everyday text and image printing.

#### **Fine**

For text and graphics with good quality and print speed.

#### **Quality**

For photos and graphics with good quality and print speed.

#### **Best Quality**

For the best print quality, but the slowest print speed.

**Parent topic:** [Selecting Basic Print Settings - Mac](#)

## Print Options - Mac

You can select any of the print options to customize your print. Some options may be unavailable, depending on other settings you have chosen.

### Expansion

If you selected a borderless paper size setting, this option adjusts the image expansion settings to control printing at the edges of borderless prints.

### Grayscale

Prints text and graphics in black or shades of gray.

### Mirror Image

Lets you flip the printed image horizontally.

**Note:** If you select the **Min** option for the Expansion setting, you may see white borders on your printed photo.

Parent topic: [Selecting Basic Print Settings - Mac](#)

## Selecting Page Setup Settings - Mac

Depending on your application, you may be able to select the paper size and orientation settings from the print window.

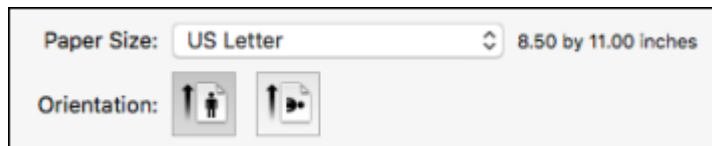

**Note:** If you do not see these settings in the print window, check for them in your application before printing. They may be accessible by selecting **Page Setup** from the File menu.

1. Select the size of the paper you loaded as the **Paper Size** setting. If you are printing a borderless photo, select the **Borderless** checkbox or a paper size with a **Borderless** option. You can also select a custom setting to create a custom paper size, but the Quality setting will be limited to **Normal**.

**Note:** You must select a compatible borderless paper type and size to print without borders. Check the borderless paper compatibility list for details.

2. Select the orientation of your document or photo as shown in the print window.

**Note:** If you are printing an envelope, select the  icon.

**Note:** You can reduce or enlarge the size of the printed image by selecting **Paper Handling** from the pop-up menu and selecting a scaling option.

**Parent topic:** [Printing on a Mac](#)

**Related references**

[Borderless Paper Type Compatibility](#)

## Selecting Print Layout Options - Mac

You can select a variety of layout options for your document or photo by selecting **Layout** from the pop-up menu on the print window.

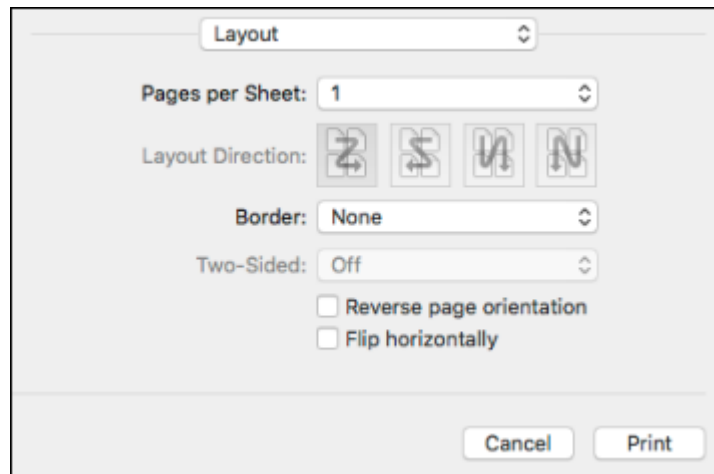

- To print multiple pages on one sheet of paper, select the number of pages in the **Pages per Sheet** pop-up menu. To arrange the print order of the pages, select a **Layout Direction** setting.
- To print borders around each page on the sheet, select a line setting from the **Border** pop-up menu.
- To invert or flip the printed image, select the **Reverse page orientation** or **Flip horizontally** settings.

**Parent topic:** [Printing on a Mac](#)

## Selecting Double-sided Printing Settings - Mac

You can print on both sides of the paper by selecting **Two-sided Printing Settings** from the pop-up menu on the print window.

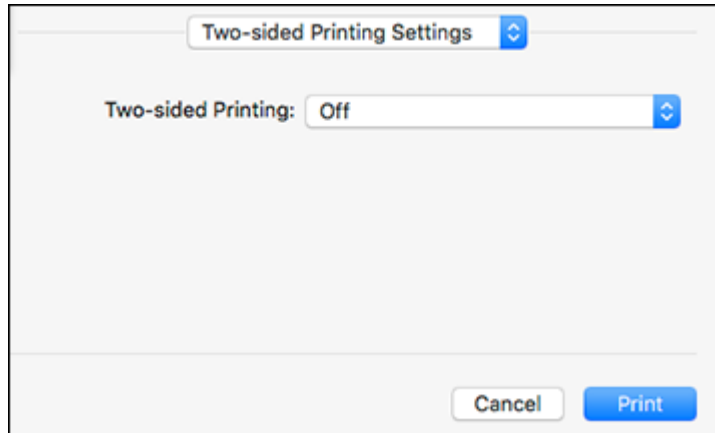

**Note:** Some options may be pre-selected or unavailable, depending on other settings you have chosen or if you are accessing the product over a network. This screen may be different, depending on the Mac OS version you are using.

1. Select one of the **Two-sided Printing** options.

2. Select the type of document you are printing as the **Document Type** setting. The software automatically sets the Adjustments options for that document type.

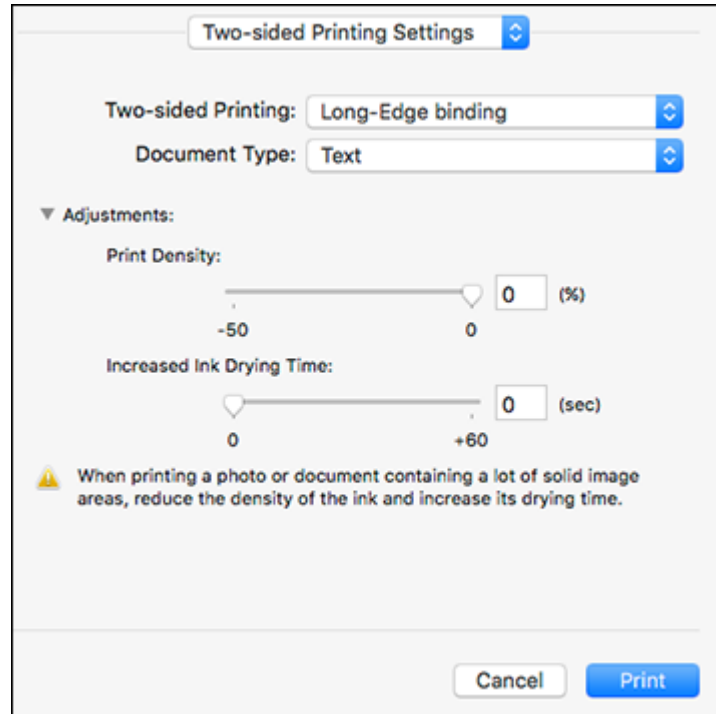

3. If necessary, customize the Adjustments settings as instructed on the screen.
4. Print a test copy of your double-sided document to test the selected settings.
5. Follow any instructions displayed on the screen during printing.

[Double-sided Printing Options and Adjustments - Mac](#)

**Parent topic:** [Printing on a Mac](#)

### **Double-sided Printing Options and Adjustments - Mac**

You can select any of the available options in the **Two-sided Printing Settings** or **Output Settings** pop-up menu to set up your double-sided print job.

## Two-sided Printing Options

### Long-Edge binding

Orients double-sided printed pages to be bound on the long edge of the paper.

### Short-Edge binding

Orients double-sided printed pages to be bound on the short edge of the paper.

## Adjustments

### Print Density

Sets the level of ink coverage for double-sided printing.

### Increased Ink Drying Time

Sets the amount of time required for drying ink after printing on one side of the paper before printing the other side in double-sided printing.

Parent topic: [Selecting Double-sided Printing Settings - Mac](#)

## Managing Color - Mac

You can adjust the Color Matching and Color Options settings to fine-tune the colors in your printout, or turn off color management in your printer software.

1. Select **Color Matching** from the pop-up menu in the print window.

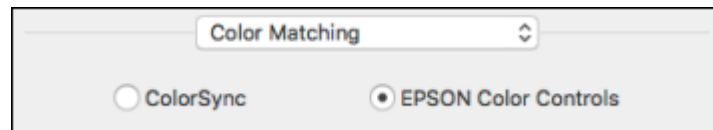

2. Select one of the available options.

3. Select **Color Options** from the pop-up menu in the print window.

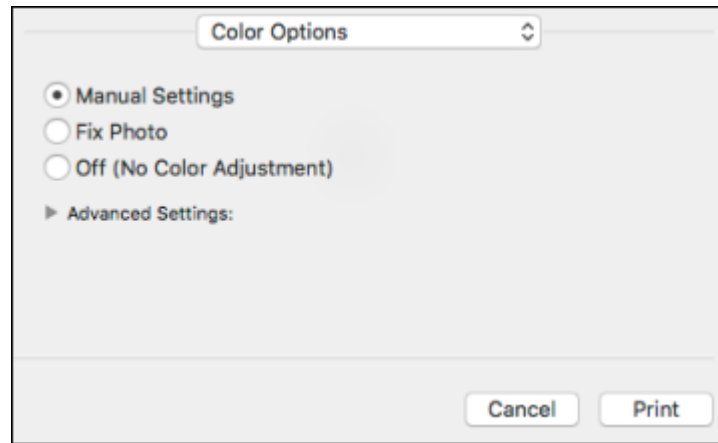

**Note:** The available settings on the Color Options menu depend on the option you selected on the Color Matching menu.

4. Select one of the available options.

[Color Matching and Color Options - Mac](#)

**Parent topic:** [Printing on a Mac](#)

### **Color Matching and Color Options - Mac**

You can select from these settings on the **Color Matching** and **Color Options** menus.

#### **Color Matching Settings**

##### **EPSON Color Controls**

Lets you manage color using controls in your printer software or turn off color management.

##### **ColorSync**

Prints using standard color profiles for your product and paper to help match image colors. You can customize the conversion method and filter settings on the ColorSync pop-up menu in the print window.

## Color Options Settings

### Manual Settings

Lets you select manual color adjustments. Click the arrow next to **Advanced Settings** and select settings for **Brightness**, **Contrast**, **Saturation**, and individual color tones. You can also select a color **Mode** setting for printing photos and graphics and the **Fix Red-Eye** setting to reduce or remove red-eye in photos. Depending on the selected color mode, you can also adjust the midtone density using the **Gamma** setting.

### Fix Photo

Improves the color, contrast, and sharpness of flawed photos. Click the arrow next to **Advanced Settings** and select the **Fix Red-Eye** setting to reduce or remove red-eye in photos.

**Note:** Fix Photo uses a sophisticated face recognition technology to optimize photos that include faces. For this to work, both eyes and the nose must be visible in the subject's face. If your photo includes a face with an intentional color cast, such as a statue, you may want to turn off **Fix Photo** to retain the special color effects.

### Off (No Color Adjustment)

Turns off color management in your printer software so you can manage color using only your application software.

**Note:** An ICC profile is required if color management is turned off.

Parent topic: [Managing Color - Mac](#)

## Selecting Printing Preferences - Mac

You can select printing preferences that apply to all the print jobs you send to your product.

1. In the Apple menu or the Dock, select **System Preferences**.
2. Select **Print & Fax**, **Print & Scan**, or **Printers & Scanners**, select your product, and select **Options & Supplies**.
3. Select **Driver** or **Options**.

You see a screen like this:

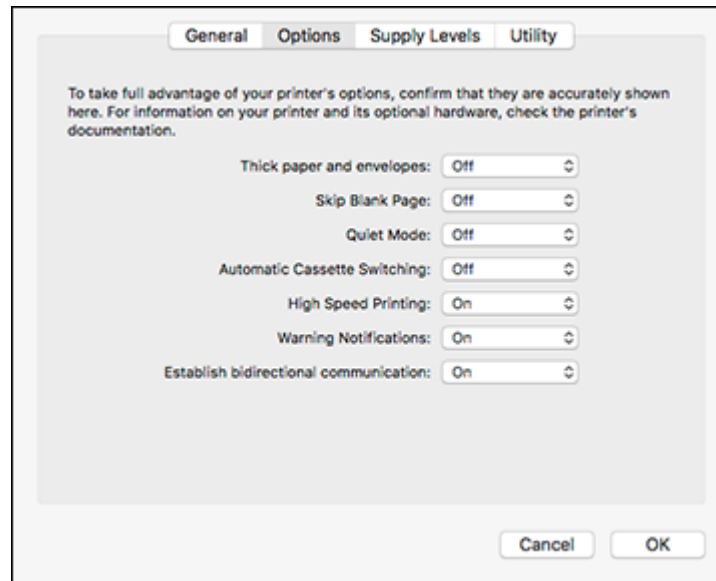

4. Select any of the available printing preferences.
5. Click **OK**.

[Printing Preferences - Mac](#)

Parent topic: [Printing on a Mac](#)

### Printing Preferences - Mac

You can select from these settings on the **Options** or **Driver** tab.

#### **Thick Paper and Envelopes**

Prevents ink from smearing when you print on envelopes or other thick paper.

#### **Skip Blank Page**

Ensures that your product does not print pages that contain no text or images.

#### **Quiet Mode**

Lessens noise during printing but may decrease print speed.

#### **Automatic Cassette Switching**

Automatically switches to the other cassette when one of the cassettes runs out of paper.

**High Speed Printing**

Speeds up printing but may reduce print quality.

**Warning Notifications**

Lets you choose whether or not to receive warning notifications from the printer software for various operating conditions.

**Establish bidirectional communication**

Allows the product to communicate with the computer. Do not change the default setting unless you experience issues when using a shared printing pool.

**Parent topic:** [Selecting Printing Preferences - Mac](#)

**Printing Your Document or Photo - Mac**

Once you have selected your print settings, you are ready to print.

Click **Print** at the bottom of the print window.

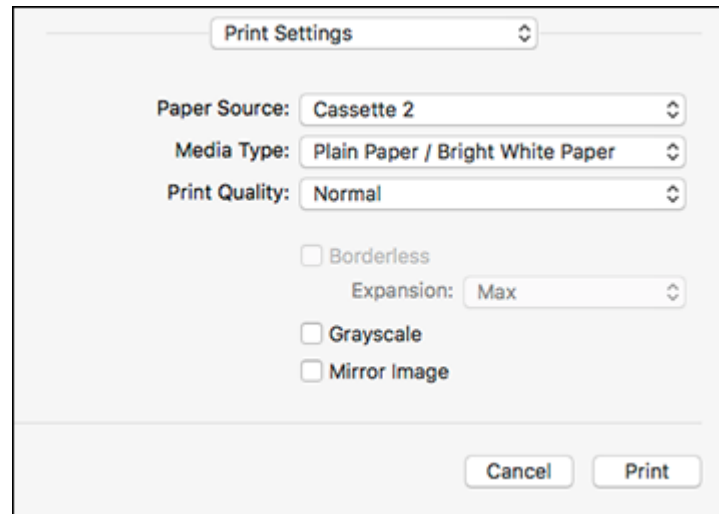

[Checking Print Status - Mac](#)



**Parent topic:** [Printing on a Mac](#)

**Checking Print Status - Mac**

During printing, you can view the progress of your print job, control printing, and check ink status.

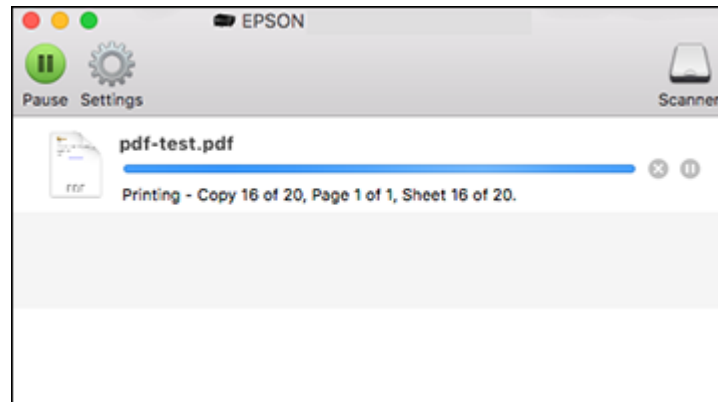
1. Click the printer icon when it appears in the Dock.  
You see the print status window:



2. Select the following options as necessary for your Mac OS version:
  - To cancel printing, click the print job and click  or **Delete**.
  - To pause a print job, click the print job and click  or **Hold**. To resume a print job, click the paused print job and click  or **Resume**.
  - To pause printing for all queued print jobs, click **Pause** or **Pause Printer**.
  - To display other printer information, click **Settings** or **Supply Levels**.

Parent topic: [Printing Your Document or Photo - Mac](#)

## Cancelling Printing Using a Product Button

If you need to cancel printing, press the  cancel button on your product.

Parent topic: [Printing from a Computer](#)

---

# Scanning

You can scan your originals and save them as digital files.

[Starting a Scan](#)

[Scanning in Epson Scan 2](#)

## Starting a Scan

After placing your originals on your product for scanning, start scanning using one of these methods.

[Starting a Scan Using the Product Control Panel](#)

[Starting a Scan Using the Epson Scan 2 Icon](#)

[Starting a Scan from a Scanning Program](#)

[Scanning from Smart Devices](#)

**Parent topic:** [Scanning](#)

## Starting a Scan Using the Product Control Panel

You can scan an image to your computer using your product's control panel buttons.

Your product automatically selects suitable default scan settings, but you can view or change them as necessary.

1. Make sure you installed the product software and connected the product to your computer or network.

**Note:** Restart your computer after installing the product software to enable scanning from the control panel. Also make sure the Event Manager program is not being blocked by your firewall or security software.

2. Press the  home button, if necessary.
3. Press the arrow buttons to select **Scan** and press the **OK** button.

You see a screen like this:



4. Select a scan option and press the **OK** button.
  - **Scan to Memory Card** saves your scan file on a memory card and lets you select the file format, quality, and other settings.
  - **Scan to Cloud** sends your scanned files to a destination that you have registered with Epson Connect.

**Note:** To use this feature, you must have registered a cloud account with Epson Connect.
  - **Scan to Computer (JPEG)** saves your scan as a JPEG file to your computer or as an image capture on a Mac.
  - **Scan to Computer (PDF)** saves your scan as a PDF file to your computer or as an image capture on a Mac.
  - **Scan to Computer (Email)** scans your original and attaches it to a message in your e-mail program. You can select the e-mail program you want to use and resize your image, if necessary, from an option screen on your computer.

**Note:** This works with MAPI-type email such as Microsoft Outlook, Windows Live Mail, Mac Mail, and Entourage, but not web-based email such as Gmail.
- **Scan to Computer (WSD)** lets you manage wireless scanning in Windows.

**Note:** To use this feature, you must first set up WSD (Web Services for Devices) on the computer you want to scan to.

5. To scan to your PC, select how you connected your product to your computer:
  - If your product is connected directly to your computer with a USB cable, select **USB Connection**.
  - If your product is connected to your computer over a network, select the computer name from the list.
6. Press the  start button to start scanning.

[Scan to Memory Card Options](#)

[Changing Default Scan Job Settings](#)

Parent topic: [Starting a Scan](#)

### Scan to Memory Card Options

Select the **Scan to Memory Card** options you want to use.



Scan to Memory Card setting	Available options	Description
Format	JPG PDF	<b>JPG:</b> for photos <b>PDF:</b> for documents
Color	Color B&W	Select color or black-and-white scans
Scan Area	Letter A4 Auto Cropping Max Area	Selects the page size for documents or special settings for photos. <b>Auto Cropping:</b> for photos with dark edges <b>Max Area:</b> for most photos
Document	Text Photograph	Selects the type of original you are scanning
Resolution	200 dpi 300 dpi 600 dpi	<b>200 dpi:</b> for e-mailing or posting on the web <b>300 dpi:</b> for printing or OCR <b>600 dpi:</b> for highest quality printing

Scan to Memory Card setting	Available options	Description
<b>Contrast</b>	Various levels	Decrease or increase image contrast
<b>Document Orientation</b>	<b>Portrait</b> <b>Landscape</b>	Specifies the orientation of your originals

Parent topic: [Starting a Scan Using the Product Control Panel](#)

### Changing Default Scan Job Settings

You can view or change the default scan job settings your product uses when you scan to your computer. You do this using the Event Manager program.



1. Do one of the following to open Event Manager:
  - **Windows 10:** Click  and select **EPSON Software > Event Manager**.
  - **Windows 8.x:** Navigate to the **Apps** screen and select **Event Manager**.
  - **Windows (other versions):** Click  or **Start > All Programs** or **Programs > EPSON Software > Event Manager**.
  - **Mac:** Open the **Applications** folder, click **Epson Software**, and select **Event Manager**.
2. Open the **Scanner** (Windows) or **Select Scanner** (Mac) drop-down list and select your product, if necessary.
3. Click **Make Job Settings**.
4. Open the **Edit Job Settings** drop-down list and select the scan job settings you want to view or change.
5. Change the settings as necessary.
6. Click **OK**.
7. Click **Close** to close the Event Manager window.

Parent topic: [Starting a Scan Using the Product Control Panel](#)

### Starting a Scan Using the Epson Scan 2 Icon

You can start the Epson Scan 2 program to select scan settings, scan, and save the scanned image to a file.

**Note:** If you are using your Epson product with the Windows 10 S operating system, you cannot use the software described in this section. You also cannot download and install any Epson product software from the Epson website for use with Windows 10 S; you must obtain software only from the Windows Store.

- **Windows 10:** Click  and select **EPSON > Epson Scan 2**.
- **Windows 8.x:** Navigate to the **Apps** screen and select **Epson Scan 2**.
- **Windows (other versions):** Click  or **Start**, and select **All Programs** or **Programs**. Select **EPSON > Epson Scan 2 > Epson Scan 2**.
- **Mac:** Open the **Applications** folder, open the **Epson Software** folder, and select **Epson Scan 2**.

You see an Epson Scan 2 window like this:

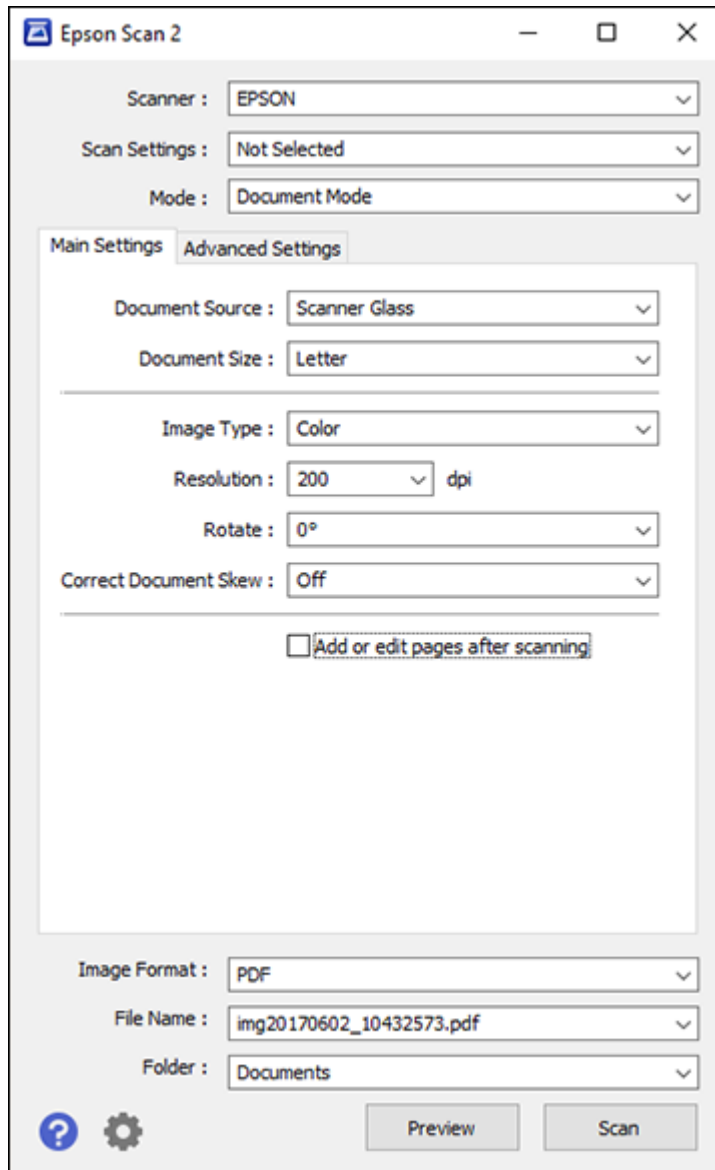

Parent topic: [Starting a Scan](#)

## Starting a Scan from a Scanning Program

You can start Epson Scan 2 from a TWAIN-compliant scanning program to select scan settings, scan, and open the scanned image in the program.

**Note:** If you are using your Epson product with the Windows 10 S operating system, you cannot use the software described in this section. You also cannot download and install any Epson product software from the Epson website for use with Windows 10 S; you must obtain software only from the Windows Store.

1. Open your scanning program and select its scanning option. (See your scanning program help for instructions.)
2. Select your product.

**Note:** In certain programs, you may need to select your product as the "source" first. If you see a **Select Source** option, choose it and select your product. With Windows, do not select a **WIA** option for your product; it will not work correctly.

You see an Epson Scan 2 window like this:

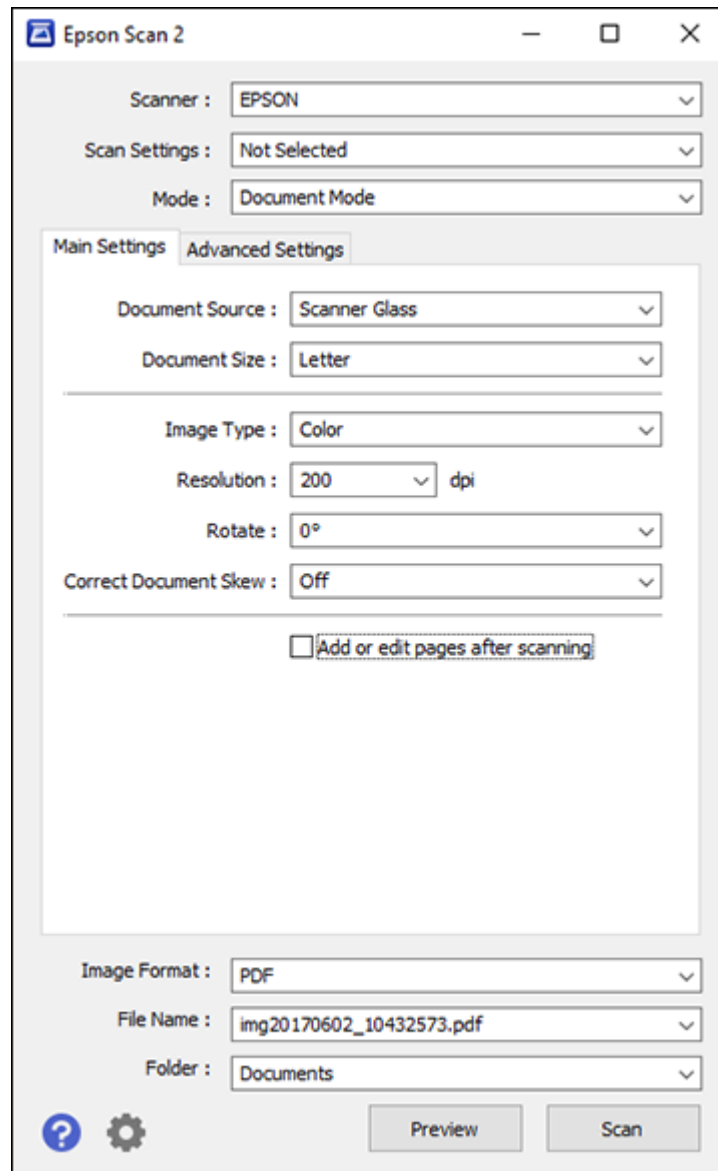

**Parent topic:** [Starting a Scan](#)

## Scanning from Smart Devices

Using the Epson iPrint application, you can use your iOS or Android smartphone or tablet to scan original documents or photos on your networked product and save them as digital files on your device.

Follow the link here for more information on Epson iPrint.

**Parent topic:** [Starting a Scan](#)

### Related tasks

[Using the Epson iPrint Mobile App](#)

## Scanning in Epson Scan 2

Epson Scan 2 automatically scans your document and saves the scanned file in PDF format in your operating system's Documents or My Documents folder, or opens it in your scanning program. You can select settings, preview, and change the scanned file settings as necessary.

**Note:** If you are using your Epson product with the Windows 10 S operating system, you cannot use the software described in this section. You also cannot download and install any Epson product software from the Epson website for use with Windows 10 S; you must obtain software only from the Windows Store.

1. Start Epson Scan 2.

You see this window:

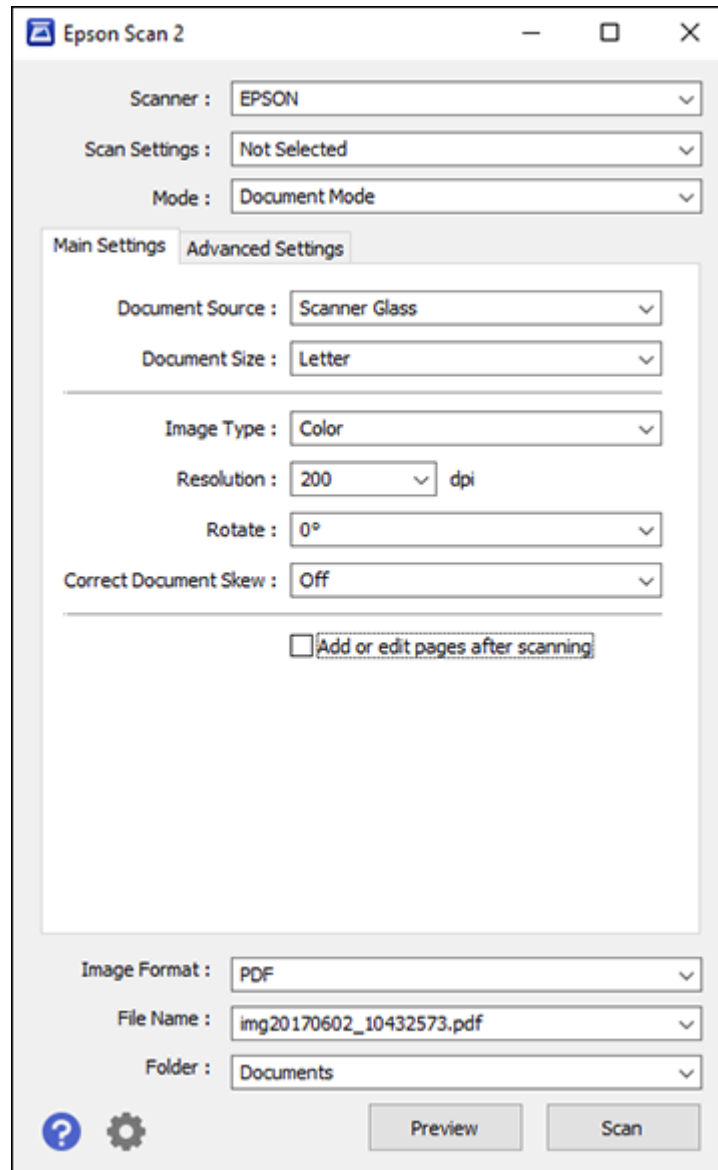

2. Select the **Mode** setting that matches the type of original you are scanning.
3. Select the **Document Source** setting that matches where you placed your original.
4. Select the **Document Size** setting that matches the size of your original. You can select **Customize** to enter a custom size, if necessary.
5. Select the image type of your original and how you want it scanned as the **Image Type** setting.
6. Select the **Resolution** setting you want to use for your scan.
7. Select the **Rotate** setting to rotate the scanned image.
8. Select the **Correct Document Skew** setting to correct skewed originals, image contents, or both.
9. Click the **Preview** button.

Epson Scan 2 previews your original and displays the results in the Epson Scan 2 window.

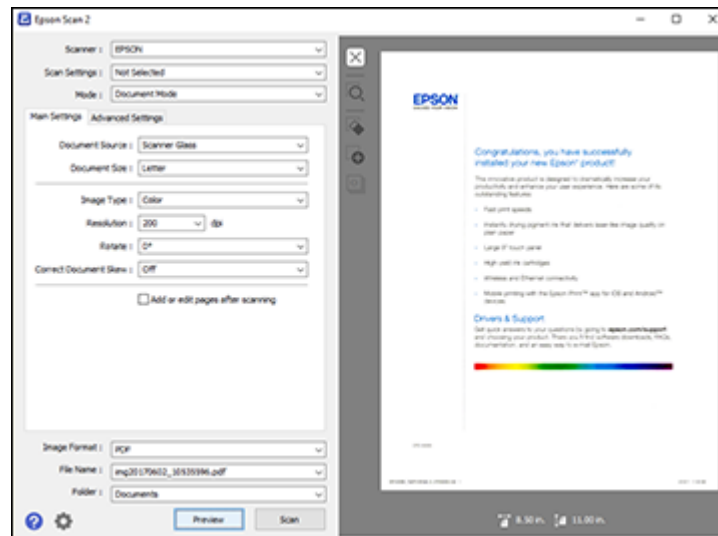

10. Do one of the following:
  - If you're scanning in Document Mode, select any of the additional settings that you want to use on the Main Settings tab.
  - If you're scanning in Photo Mode, select the **Color Management** and **Thumbnail Options** settings as necessary.
11. Click the **Advanced Settings** tab and select any settings that you want to use.

12. Select the format in which you want to save your scanned file as the **Image Format** setting. If necessary, select **Options** and select any desired format options.
13. Enter the file name for your scanned file in the **File Name** field. If necessary, select **Settings** to modify the file name settings.
14. Select the location in which you want to save your scanned file as the **Folder** setting. If necessary, select **Select** to create a new folder.
15. Click **Scan**.

The product scans your original and saves the scanned file in the location you specified.

[Additional Scanning Settings - Main Settings Tab](#)

[Additional Scanning Settings - Advanced Settings Tab](#)

[Saving Scanned Documents as a Searchable PDF](#)

**Parent topic:** [Scanning](#)

## Additional Scanning Settings - Main Settings Tab

You can select these additional scanning settings on the Epson Scan 2 Main Settings tab. Not all adjustment settings may be available, depending on other settings you have chosen.

### **Correct Document Skew**

Corrects skewed originals, image contents, or both.

### **Add or edit pages after scanning**

Lets you add, remove, or edit the pages in a job, including rotating pages and changing the page order.

**Note:** To save multiple pages in a single file, you must select a file format that supports multiple pages such as **PDF** or **Multi-TIFF**. If you select another file format, each scanned image or page is saved as a separate file.

**Parent topic:** [Scanning in Epson Scan 2](#)

## Additional Scanning Settings - Advanced Settings Tab

You can select these additional scanning settings on the Epson Scan 2 Advanced Settings tab. Not all adjustment settings may be available, depending on other settings you have chosen.

### **Remove Background**

Removes the background of the originals.

**Text Enhancement**

Sharpens the appearance of letters in text documents.

**Auto Area Segmentation**

Makes black and white images clearer and text recognition more accurate by separating the text from the graphics.

**Threshold**

Adjusts the level at which black areas in text and line art are delineated, improving text recognition in OCR (Optical Character Recognition) programs.

**Color Enhance**

Enhances the shades of the color you select in the scanned image. This setting is available only if you select **Grayscale** or **Black & White** as the Image Type setting.

**Brightness**

Adjusts the overall lightness and darkness of the scanned image.

**Contrast**

Adjusts the difference between the light and dark areas of the overall scanned image.

**Gamma**

Adjusts the midtone density of the scanned image.

**Unsharp Mask**

Makes the edges of certain image areas clearer. Turn off this option to leave softer edges.

**Descreening**

Removes the ripple pattern that might appear in subtly shaded image areas, such as skin tones. This option improves results when scanning magazines or newspapers. (The results of descreening do not appear in the preview image, only in your scanned image.)

**Edge Fill**

Corrects shadowing around the edges of the image by filling the shadows with black or white.

**Dual Image Output**

Scans the original image twice using different output settings (Windows only).

Parent topic: [Scanning in Epson Scan 2](#)

## **Saving Scanned Documents as a Searchable PDF**

You can scan a document and save the text in a searchable PDF. In a searchable PDF, text is recognized using Optical Character Recognition (OCR) and then embedded in the scanned original.

**Note:** The required Epson Scan 2 OCR Component is installed automatically when you install your product software as instructed on the *Start Here* sheet. If you install your scanner software programs individually, be sure to also install this component if you want to perform OCR.

1. Load your original in the product for scanning.
2. Start Epson Scan 2.
3. Select your scan settings.
4. Click **Preview** and adjust the area you want to scan, if necessary.
5. Select **Searchable PDF** as the Image Format setting.
6. Select **Options** from the Image Format list.

You see this window:

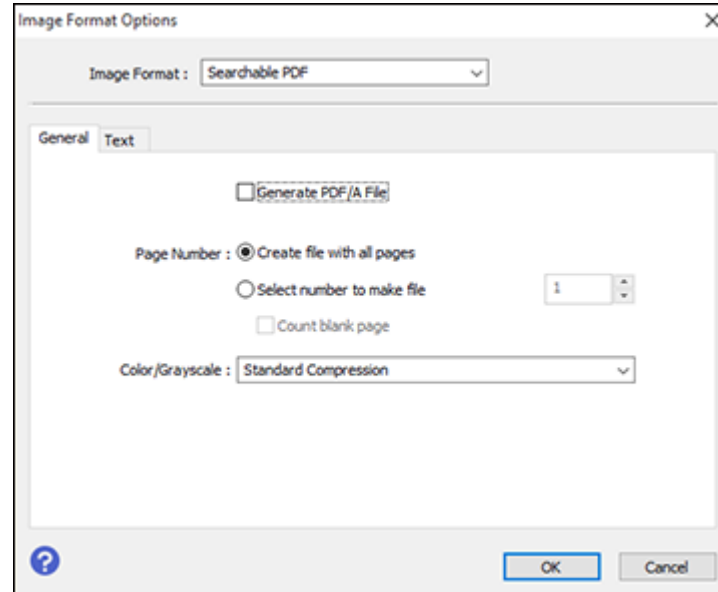

7. Select any of the options on the **General** tab.
8. Select the **Text** tab.
9. Make sure the language used in the document text is selected as the **Text Language** setting.
10. Click **OK**.

11. Confirm the File Name setting and select a **Folder** setting for your document.
12. Click **Scan**.

The scanned image is saved as a searchable PDF.

**Parent topic:** [Scanning in Epson Scan 2](#)

---

# Using Memory Cards with Your Product

Follow the instructions here to work with a memory card inserted into your product.

[Inserting a Memory Card](#)

[Printing from a Memory Card](#)

[Transferring Photos on a Memory Card](#)

## Inserting a Memory Card

Insert only one memory card at a time into the memory card slot on your product.

1. Make sure the memory card and the files on it are compatible with your product before inserting the card.
2. Insert your memory card into the slot, making sure the card is oriented correctly.

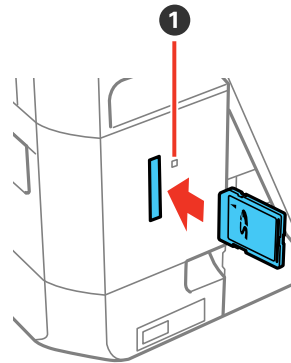

1 Memory card access light

**Note:** Do not force the card all the way into the slot. Insert it only until it meets resistance.

The memory card access light flashes and then stays lit.

**Caution:** Do not remove the memory card or turn off your product while the memory card access light is flashing, or you may lose data from the memory card.

[Memory Card Types](#)  
[Memory Card File Specifications](#)  
[Removing a Memory Card](#)

**Parent topic:** [Using Memory Cards with Your Product](#)

## Memory Card Types

You can insert these types of memory cards in your product.

**Note:** Cards marked with an asterisk (\*) require an adapter; consult your adapter documentation for details on using it.

You can insert the following cards in the memory card slot:

- SD: 2GB
- SDHC: 32GB
- SDXC: 64GB
- miniSD\*: 2GB
- miniSDHC\*: 32GB
- microSD\*: 2GB
- microSDHC\*: 32GB
- microSDXC\*: 64GB

**Parent topic:** [Inserting a Memory Card](#)

## Memory Card File Specifications

You can insert memory cards in your product containing files that meet these specifications.

<b>File format</b>	JPEG with the Exif version 2.3 standard (taken with digital camera using DCF (Design rule for Camera File system) version 1.0 or 2.0 compliant)
<b>Image size</b>	80 × 80 pixels to 10200 × 10200 pixels
<b>File size</b>	Up to 2GB
<b>Number of files</b>	Up to 9990

**Note:** DCF 2.0 files stored in a camera's built-in memory are not supported.

**Parent topic:** [Inserting a Memory Card](#)

## Removing a Memory Card

After you finish working with a memory card, check to make sure it is safe to remove it from your product.

**Caution:** Do not remove a memory card or turn off your product while the memory card access light is flashing or you may lose data from the memory card.

1. Make sure the memory card access light is not flashing.

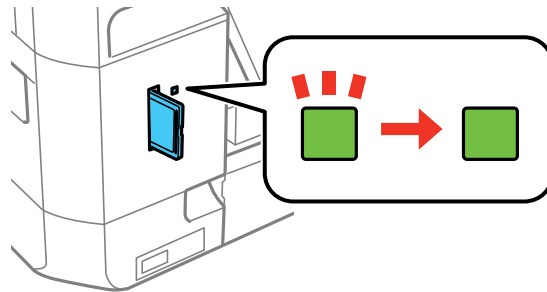

2. If your product is connected to your computer using a USB cable, do one of the following:
  - **Windows:** Open the **My Computer**, **Computer**, **Windows Explorer**, or **File Explorer** utility. Then right-click the name of your memory card (listed as a removable disk) and select **Eject**.
  - **Mac:** Drag the removable disk icon for your memory card from the desktop or computer window into the trash.
3. Push in the memory card, then pull it straight out of its slot.

**Parent topic:** [Inserting a Memory Card](#)

## Printing from a Memory Card

See these sections to print photos from a memory card inserted into your product:

[Viewing and Printing Photos](#)

[Printing Photo Layouts from a Memory Card](#)

[Printing Photo Greeting Cards](#)

**Parent topic:** [Using Memory Cards with Your Product](#)

## Viewing and Printing Photos

See these sections to view and print photos displayed on your product's LCD screen.

[Viewing and Printing Photos From the LCD Screen](#)

[Print Setting Options - Memory Card](#)

[Photo Adjustment Options - Memory Card](#)

**Parent topic:** [Printing from a Memory Card](#)

### Viewing and Printing Photos From the LCD Screen

You can select photos for printing as you view them on the LCD screen.

1. Press the  home button, if necessary.
2. Press the arrow buttons to select **Print Photos** and press the **OK** button.

A photo on your memory card is displayed:



3. Press the right or left arrow button to scroll through your photos and display one that you want to view or print.
4. Press the + or – button to select one or more copies of the photo (up to 99).
5. To view and select additional photos for printing, repeat the steps above.
6. To view additional settings, press the down arrow button.

You see this screen:

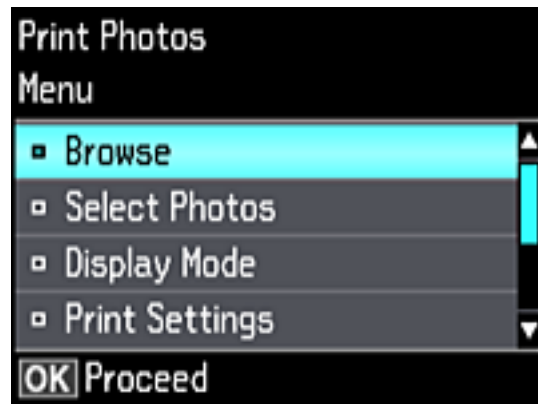

7. Do one of the following:
  - To locate photos by date, select **Browse**, press the **OK** button twice, and select the photos you want.
  - To change the selected photos and number of copies to print, select **Select Photos**, press the **OK** button, and select the necessary settings.
  - To change the display setting for the LCD screen, select **Display Mode**, press the **OK** button, and select the setting you want.
  - To change the print settings, select **Print Settings**, press the **OK** button, and select the necessary settings.
  - To change the appearance (e.g., brightness and contrast) of your printed photos, select **Photo Adjustments**, press the **OK** button, and select the necessary settings.
  - To apply a sepia tone or black-and-white filter to the viewed or printed photo, select **Filter**, press the **OK** button, and select the necessary settings.
  - To crop or zoom into your photo, select **Crop/Zoom**, press the **OK** button, and press the **+** or **-** button to adjust the image area or the **⬆** home button to rotate the crop area. When you are finished, press the **OK** button twice.
8. When you are ready to print, press the **⬅** start button.

**Note:** To cancel printing, press the **⏏** cancel button.

**Parent topic:** [Viewing and Printing Photos](#)

**Related references**

[Photo Adjustment Options - Memory Card](#)

[Print Setting Options - Memory Card](#)

**Print Setting Options - Memory Card**

Select the **Print Settings** options you want to use when printing photos displayed on the LCD screen.

**Note:** To return to the default print settings, press the  cancel button, select **No**, and press the **OK** button.

<b>Print settings</b>	<b>Available options</b>	<b>Description</b>
<b>Paper Size</b>	Various paper sizes	Indicates the size of paper you have loaded
<b>Paper Type</b>	Various paper types	Indicates the type of paper you have loaded; see the list of paper types for copying (available options depend on the selected <b>Paper Size</b> setting)
<b>Paper Source</b>	<b>Cassette 1</b>	Prints onto paper loaded in Cassette 1 (upper cassette)
	<b>Cassette 2</b>	Prints onto paper loaded in Cassette 2 (lower cassette)
	<b>Cassette 1&gt;Cassette 2</b>	Prints onto paper loaded in Cassette 1 and then onto paper loaded in Cassette 2 when the first cassette is empty (load the same size and type of paper in both cassettes when selecting this option)
	<b>Rear Paper Feed Slot</b>	Prints onto paper loaded in the rear paper feed slot
<b>Borderless</b>	<b>Borderless</b>	Expands the image to the edge of the paper (slight cropping may occur)
	<b>With Border</b>	Leaves a small margin around the image
<b>Quality</b>	<b>Draft</b>	Provides lower quality for draft printing
	<b>Standard</b>	Provides good quality for most prints
	<b>Best</b>	Provides the highest quality for important prints

Print settings	Available options	Description
<b>Expansion</b>	<b>Standard</b>	Expands images correctly for most borderless prints
	<b>Medium</b>	Expands images slightly less for borderless prints
	<b>Minimum</b>	Expands images the least for borderless prints (you may see some white border)
<b>Date</b>	Various date formats	Prints the date the photo was taken on the photo in the format you select
<b>Print Info. On Photos</b>	<b>Off</b>	Turns off this setting
	<b>Camera Text</b>	Prints text that you added in your camera
	<b>Landmark</b>	Prints location information embedded in a photo by cameras that have a built-in GPS feature
<b>Fit Frame</b>	<b>On</b>	Automatically crops the photo to fit into the selected photo layout
	<b>Off</b>	Turns off automatic cropping
<b>Bidirectional</b>	<b>On</b>	Prints at normal speed
	<b>Off</b>	Slows down printing to improve print quality

**Parent topic:** [Viewing and Printing Photos](#)

**Related references**

[Photo Adjustment Options - Memory Card](#)

[Paper Type Settings - Copying](#)

[Paper Size Settings - Copying](#)

**Related tasks**

[Viewing and Printing Photos From the LCD Screen](#)

**Photo Adjustment Options - Memory Card**

Select the **Photo Adjustment** options you want to use when viewing and printing photos displayed on the LCD screen. The modifications affect only the printed copy of the photo, not the original file.

Photo Adjustment settings	Available options	Description
<b>Fix Photo</b>	<b>Fix Photo On</b>	Automatically adjusts the brightness, contrast, and saturation of the photo based on the <b>Scene Detection</b> setting that is selected.
	<b>Fix Photo Off</b>	Turns off automatic adjustments; see <b>Note</b> below
	<b>P.I.M.</b>	Uses your camera's PRINT Image Matching or Exif Print adjustments
<b>Scene Detection</b>	<b>Automatic</b>	Optimizes the <b>Fix Photo</b> adjustments for specific types of photos; select the option that best matches your photo content
	<b>People</b>	
	<b>Landscape</b>	
	<b>Night Scene</b>	
<b>Fix Red-Eye</b>	<b>Off - Current</b>	Automatically fixes the red-eye effect in photos
	<b>On - Current</b>	
<b>Brightness</b>	Various settings	Adjust individual qualities in your photo
<b>Contrast</b>		
<b>Sharpness</b>		
<b>Saturation</b>		

**Note:** **Fix Photo** uses a sophisticated face recognition technology to optimize photos that include faces. For this to work, both eyes and the nose must be visible in the subject's face. If your photo includes a face with an intentional color cast, such as a statue, you may want to turn off **Fix Photo** to retain the special color effects.

**Parent topic:** [Viewing and Printing Photos](#)

**Related references**

[Print Setting Options - Memory Card](#)

**Related tasks**

[Viewing and Printing Photos From the LCD Screen](#)

## Printing Photo Layouts from a Memory Card

You can print one or more photos from a memory card in special layouts on various sizes of photo paper.

1. Load photo paper in your product.
2. Press the **⬆** home button, if necessary.
3. Press the arrow buttons to select **More Functions** and press the **OK** button.
4. Select **Photo Layout Sheet** and press the **OK** button.

You see this screen:

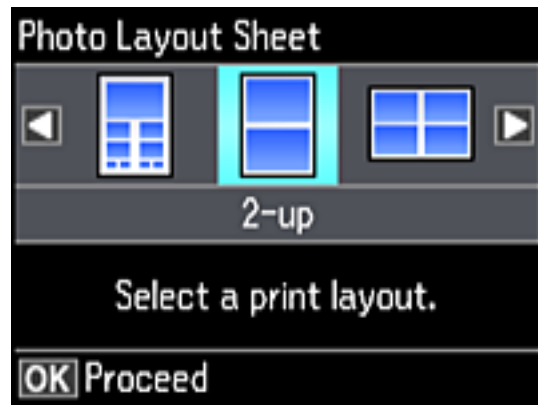

5. Select one of the layout options and press the **OK** button.

You see this screen:

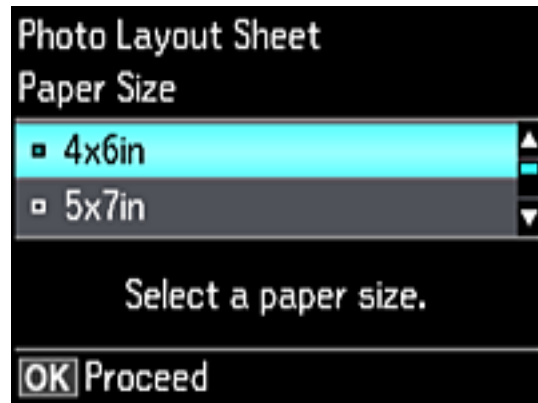

6. Select the **Paper Size** setting that matches the paper you loaded and press the **OK** button.
7. Select the **Paper Type** setting that matches the paper you loaded and press the **OK** button.

Depending on the layout you selected, you may see this screen:

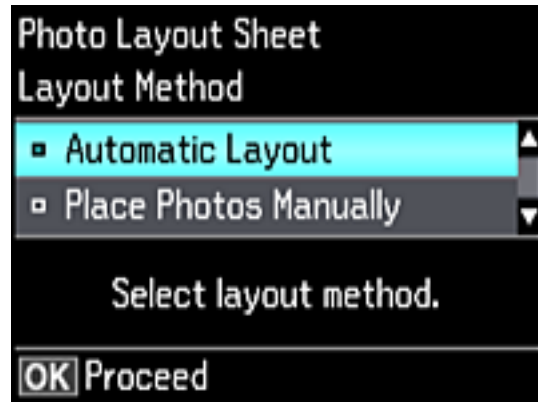

8. If you see the screen above, do one of the following:
  - To allow your product to place photos in the layout automatically, select **Automatic Layout** and press the **OK** button. Press the **+** button to select a photo to print. If you need to deselect a photo, press the **-** button. Press the **OK** button when you're finished.

- To place photos in the layout manually, select **Place Photos Manually** and press the **OK** button. Press the arrow buttons to change layout options, pressing the **OK** button to confirm each photo placement.

**Note:** If the product does not automatically advance to the next screen when you finish placing your photos, press the arrow buttons to select **Finished** and press the **OK** button.

9. If you want to change the print settings for the photo layout sheet, press the up or down arrow button to select **Menu** and press the **OK** button.
10. Press the **+** or **-** button to select one or more copies of each photo layout sheet (up to 99).
11. Press the **OK** button.
12. To print more than one copy of the photo layout sheet, press the **+** or **-** button to select the number (up to 99).
13. When you are ready to print, press the  start button.

**Note:** To cancel printing, press the  cancel button.

### [Photo Layout Options](#)

**Parent topic:** [Printing from a Memory Card](#)

#### **Related references**

[Paper Type Settings - Copying](#)

[Paper Size Settings - Copying](#)

#### **Related topics**

[Loading Paper](#)

### **Photo Layout Options**

Select the layout you want to use when printing your photos in a layout.

#### **Picture Package**

Prints one photo in multiple sizes on one sheet.

#### **2-up, 4-up, 8-up, or 20-up**

Print 2, 4, 8, or 20 photos on one sheet.

#### **Upper ½ or Lower ½**

Print one photo in the upper or lower half of the sheet.

**Photo ID**

Prints 4 ID-sized photos on one sheet.

**Jewel Upper**

Prints one photo on the upper half of a folded jewel case insert.

**Jewel Index**

Prints 24 to 48 thumbnail images on a folded jewel case insert.

**Parent topic:** [Printing Photo Layouts from a Memory Card](#)

## Printing Photo Greeting Cards

You can create custom greeting cards using photos on your memory card or other device, and add your own handwritten or printed text.

First you select your photo and print a template on plain paper. Then you fill out the template, add your message, and print your cards.

[Creating and Printing a Greeting Card Template](#)

[Printing a Greeting Card from a Template](#)

**Parent topic:** [Printing from a Memory Card](#)

### Creating and Printing a Greeting Card Template

Before you start, make sure plain paper is loaded and your memory card is inserted.

1. Press the  home button, if necessary.
2. Press the arrow buttons to select **More Functions** and press the **OK** button.
3. Select **Print Photo Greeting Card** and press the **OK** button.



4. Select **Select Photo and Print Template** and press the **OK** button.
5. Press the left or right arrow button to select the photo you want and press the **OK** button.
6. Select **Letter** to print three cards on one letter-size sheet or **4x6in** to print one card. Then press the **OK** button.
7. Select the type of paper you plan to use and press the **OK** button.
8. Select the other print settings as necessary, pressing the **OK** button after each selection.
9. When you are ready to print your greeting card template on plain paper, press the  $\diamond$  start button.

**Parent topic:** [Printing Photo Greeting Cards](#)

#### **Related tasks**

[Printing a Greeting Card from a Template](#)

### **Printing a Greeting Card from a Template**

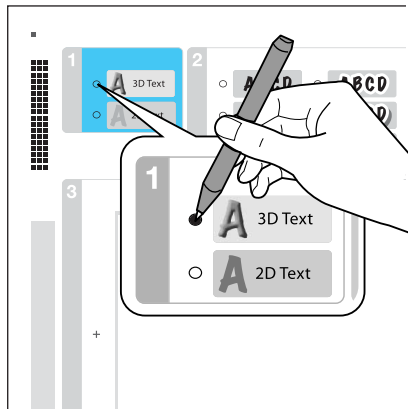

After your greeting card template is printed, you fill it out to create your card and add your message.

1. Use a dark pen or pencil to fill in the circles and select the Text Style and Text Effects.



2. Add your greeting card message within the box. You can write it in by hand, print a message and paste it into the box, or draw a picture.

**Note:** When adding text, place it in the direction that your photo faces.

3. Load photo paper either in Cassette 2 (lower) for this size: Letter (8.5 × 11 inches [216 × 279 mm]), or in Cassette 1 (upper) for this size: 4 × 6 inches (102 × 152 mm).
4. Select **Print Greeting Cards from Template** and press the **OK** button. (If you do not see the option, press the  home button and select **More Functions > Print Photo Greeting Card > Print Greeting Cards from Template.**)
5. Follow the instructions on the LCD screen to place the template facedown on the scanner glass with the blue triangle facing into the front right corner.
6. Close the document cover and press the **OK** button.
7. To print more than one copy, press the **+** or **-** button to select the number (up to 99).
8. When you are ready to print, press the  start button.

**Note:** To cancel printing, press the  cancel button.

When you finish printing, cut your greeting cards apart, if necessary.

**Parent topic:** [Printing Photo Greeting Cards](#)

**Related tasks**

[Creating and Printing a Greeting Card Template](#)

## Transferring Photos on a Memory Card

You can transfer photos to and from a memory card inserted into a memory card slot on your product.

[Setting Up File Sharing for Photo Transfers from Your Computer](#)

[Transferring Photos from a Memory Card to Your Computer](#)

**Parent topic:** [Using Memory Cards with Your Product](#)

## Setting Up File Sharing for Photo Transfers from Your Computer

Before you transfer photos from a computer to a memory card inserted into a memory card slot on your product, you may need to set up your product's file sharing settings.

**Caution:** Remove the memory card before you change this setting or you may lose data from the memory card. Do not remove a memory card or turn off your product while the memory card access light is flashing or you may lose data from the memory card.

1. Remove any memory cards from the product.

2. Press the  home button, if necessary.
3. Press the arrow buttons to select **Settings** and press the **OK** button.
4. Select **File Sharing Setup** and press the **OK** button.
5. Select your connection type and press the **OK** button.

**Parent topic:** [Transferring Photos on a Memory Card](#)

#### **Related tasks**

[Removing a Memory Card](#)

## **Transferring Photos from a Memory Card to Your Computer**

You can transfer photos to and from a memory card inserted into a memory card slot on your product and a computer connected to your product.

**Note:** Do not transfer photos to and from a memory card while you are printing from the memory card.

1. Make sure your product is connected to a computer.
2. Insert a memory card into a memory card slot on your product.
3. Do one of the following to access your memory card files from your computer:
  - **Windows:** Open the **Computer**, **My Computer**, **Windows Explorer**, or **File Explorer** utility, then select the removable disk icon.
  - **Mac with a USB connection:** Look for the removable disk icon on your desktop or computer window, then select it.
  - **Mac with a network connection:** Select the hard drive icon on your desktop or computer window, select your product in the **SHARED** section of the sidebar (you may need to widen the sidebar to see the name), then select the **MEMORYCARD** icon.
4. Select the folder that contains your photos.
5. Drag the photos you want to transfer to the desired folder on your computer or on your memory card.

**Note:** Your product's LCD screen does not update to display new photos transferred to the memory card. Wait until the memory card access light stops flashing, then remove and insert the memory card to update the photos displayed.

**Parent topic:** [Transferring Photos on a Memory Card](#)

**Related tasks**

[Inserting a Memory Card](#)

---

# Using an External Device with Your Product

Follow the instructions in these sections to use your product with an external device, such as a camera, smartphone, or other device.

[Printing from a Camera](#)

[Viewing or Printing from a USB Flash Drive or External Device](#)

## Printing from a Camera

If you have a digital camera that supports PictBridge printing, you can print your photos directly from the camera. Check your camera manual to see if it is compatible.

**Note:** Your photos must be in JPG format and sized from 80 × 80 to 10200 × 10200 pixels. Epson cannot guarantee the compatibility of your camera. Some combinations of paper type, size, and layout may not be supported, depending on your camera and the product settings.

[Selecting Print and Photo Adjustment Settings](#)

[Connecting and Printing from a Camera](#)

[Printing from a Camera Wirelessly](#)

**Parent topic:** [Using an External Device with Your Product](#)

## Selecting Print and Photo Adjustment Settings

Before printing from your camera, you can make image adjustments and select the print settings for your photos. Image adjustments affect only the printed copy of the photo, not the original file.

1. Press the  home button, if necessary.

2. Press the arrow buttons to select **Settings** and press the **OK** button.

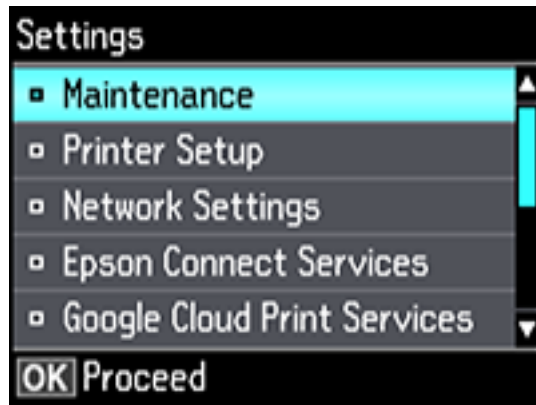

3. Select **External Device Setup** and press the **OK** button.

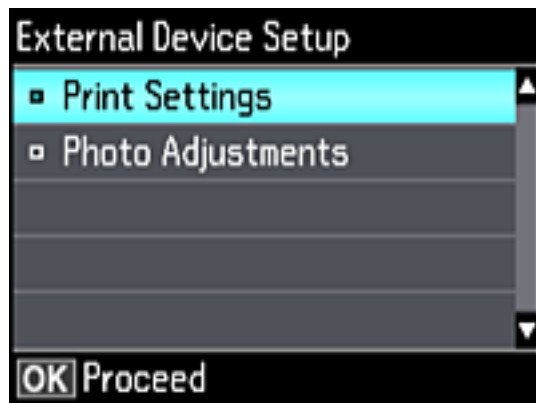

4. Select **Print Settings** and press the **OK** button.

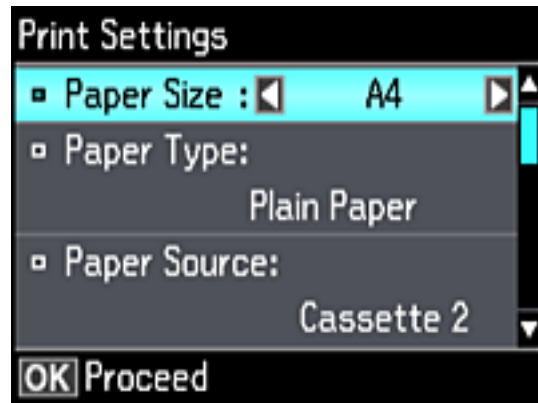

5. Select the print settings you want to use.
6. When you are done, press the ↩ back button.
7. Select **Photo Adjustments** and press the **OK** button.



8. Select the photo adjustments you want to use, then press the 🏠 home button to exit.  
After you select settings, you are ready to connect your camera and print your photos.  
[Print Settings - Camera](#)

[Photo Adjustments - Camera](#)

**Parent topic:** [Printing from a Camera](#)

**Related tasks**

[Connecting and Printing from a Camera](#)

**Print Settings - Camera**

Select these print settings options when printing photos from your camera.

<b>Print settings</b>	<b>Available options</b>	<b>Description</b>
<b>Paper Size</b>	Various paper sizes	Indicates the size of paper you have loaded
<b>Paper Type</b>	Various paper types	Indicates the type of paper you have loaded; see the list of paper types for copying (available options depend on the selected <b>Paper Size</b> setting)
<b>Paper Source</b>	<b>Cassette 1</b>	Prints onto paper loaded in Cassette 1 (upper cassette)
	<b>Cassette 2</b>	Prints onto paper loaded in Cassette 2 (lower cassette)
	<b>Cassette 1 &gt; Cassette 2</b>	Prints onto paper loaded in Cassette 1 and then onto paper loaded in Cassette 2 when the first cassette is empty (load the same size and type of paper in both cassettes when selecting this option)
	<b>Rear Paper Feed</b>	Prints onto paper loaded in the rear paper feed slot

<b>Print settings</b>	<b>Available options</b>	<b>Description</b>
<b>Layout</b>	<b>Borderless</b>	Expands the image to the edge of the paper (slight cropping may occur)
	<b>With Border</b>	Leaves a small margin around the image
	<b>Picture Package</b>	Prints one photo in multiple sizes on one sheet
	<b>1-up, 2-up, 4-up, 8-up, 20-up, and 80-up, Variety</b>	Prints the selected number of photos on one sheet or CD/DVD
	<b>Upper ½ or Lower ½</b>	Prints one photo in the upper or lower half of the sheet
	<b>Photo ID</b>	Prints 4 ID-sized photos on one sheet
	<b>Jewel Upper</b>	Prints one photo on the upper half of a folded jewel case insert
	<b>Jewel Index</b>	Prints 24 to 48 thumbnail images on a folded jewel case insert
<b>Quality</b>	<b>Draft</b>	Provides lower quality for draft printing
	<b>Standard</b>	Provides good quality for most prints
	<b>Best</b>	Provides the highest quality for important prints
<b>Expansion</b>	<b>Standard</b>	Expands images correctly for most borderless prints
	<b>Medium</b>	Expands images slightly less for borderless prints
	<b>Minimum</b>	Expands images the least for borderless prints (you may see some white border)
<b>Date</b>	<b>Off</b>	Does not print the date on which the photo was taken
	<b>On</b>	Prints the date on which the photo was taken
<b>Print Info. on Photos</b>	<b>Camera Text</b>	Prints text that you added in your camera
	<b>Landmark</b>	Prints location information embedded in a photo by cameras that have a built-in GPS feature
	<b>Off</b>	Prints no information on photos

Print settings	Available options	Description
<b>Fit Frame</b>	<b>On</b>	Automatically crops the photo to fit into the selected photo layout
	<b>Off</b>	Turns off automatic cropping
<b>Bidirectional</b>	<b>On</b>	Prints at normal speed
	<b>Off</b>	Slows down printing to improve print quality
<b>CD Inner/Outer</b>	Range of measurements	Selects inner and outer diameter for printing on CDs/DVDs from your camera
<b>CD Density</b>	<b>Standard</b>	Adjusts the print density when printing on CDs/DVDs from your camera
	<b>Darker</b>	
	<b>Darkest</b>	

Parent topic: [Selecting Print and Photo Adjustment Settings](#)

**Related references**

[Paper Type Settings - Copying](#)

[Paper Size Settings - Copying](#)

**Photo Adjustments - Camera**

Select these photo adjustment options when printing photos from your camera. The modifications affect only the printed copy of the photo, not the original file.

Photo Adjustments settings	Available options	Description
<b>Fix Photo</b>	<b>Fix Photo On</b>	Automatically adjusts the brightness, contrast, and saturation of the photo based on the <b>Scene Detection</b> setting that is selected
	<b>Fix Photo Off</b>	Turns off automatic adjustments; see <b>Note</b> below
	<b>P.I.M</b>	Uses your camera's PRINT Image Matching or Exif Print adjustments

Photo Adjustments settings	Available options	Description
<b>Scene Detection</b>	<b>Automatic</b>	Optimizes the <b>Fix Photo</b> adjustments for specific types of photos; select the option that best matches your photo content
	<b>People</b>	
	<b>Landscape</b>	
	<b>Night Scene</b>	
<b>Fix Red-Eye</b>	<b>Off</b>	Does not automatically fix the red-eye effect in photos
	<b>On</b>	Automatically fixes the red-eye effect in photos
<b>Filter</b>	<b>Off</b>	Turns off the filter setting
	<b>Sepia</b>	Applies a sepia tone filter to the viewed or printed photo
	<b>B&amp;W</b>	Applies a black-and-white filter to the viewed or printed photo
<b>Brightness</b>	Various settings	Adjust individual qualities in your photo
<b>Contrast</b>		
<b>Sharpness</b>		
<b>Saturation</b>		

**Note:** **Fix Photo** uses a sophisticated face recognition technology to optimize photos that include faces. For this to work, both eyes and the nose must be visible in the subject's face. If your photo includes a face with an intentional color cast, such as a statue, you may want to turn off **Fix Photo** to retain the special color effects.

Parent topic: [Selecting Print and Photo Adjustment Settings](#)

## Connecting and Printing from a Camera

Before you connect your camera, make sure the product is turned on but not printing.

1. Remove any memory cards from the product.
2. Load the paper you want to use for printing.

3. Connect the USB cable that came with your camera to the  USB port on the front of your product.

**Note:** You cannot use the USB port to transfer images from your camera to your computer.

4. Turn on your camera.
5. Follow the instructions that came with your camera to select and print your photos.

When you finish printing, turn off your camera and disconnect it from the product.

**Parent topic:** [Printing from a Camera](#)

**Related tasks**

[Removing a Memory Card](#)

**Related topics**

[Loading Paper](#)

## Printing from a Camera Wirelessly

You can print photos from a digital camera using a wireless connection. Make sure your digital camera can connect to a network and is PictBridge compatible (DPS over IP).

1. Remove any memory cards from the product.
2. Load the paper you want to use for printing.
3. Turn on your camera.
4. Set up the camera's wireless network connection. See the documentation that came with your camera for details.

**Note:** Connect the camera to the same network that your product uses. You can print a Network Status sheet to view your product's network settings.

5. Follow the instructions that came with your camera to select and print your photos.

When you finish printing, turn off your camera and disconnect it from the network.

**Parent topic:** [Printing from a Camera](#)

**Related tasks**

[Printing a Network Status Sheet](#)

[Removing a Memory Card](#)

## Viewing or Printing from a USB Flash Drive or External Device

You can view and print photos from a USB flash drive or other external USB device, such as an external hard drive or CD/DVD burner.

**Note:** Make sure the files on your device are compatible with the product.

[USB Device File Specifications](#)

[Connecting and Using a USB Flash Drive or External Device](#)

**Parent topic:** [Using an External Device with Your Product](#)

**Related tasks**

[Viewing and Printing Photos From the LCD Screen](#)

## USB Device File Specifications

You can print external device files that meet these specifications.

<b>File format</b>	JPEG with the Exif version 2.3 standard (taken with digital camera using DCF (Design rule for Camera File system) version 1.0 or 2.0 compliant)
<b>Image size</b>	80 × 80 pixels to 10200 × 10200 pixels
<b>File size</b>	Up to 2GB
<b>Number of files</b>	Up to 9990

**Note:** DCF 2.0 files stored in a camera's built-in memory are not supported.

**Parent topic:** [Viewing or Printing from a USB Flash Drive or External Device](#)

## Connecting and Using a USB Flash Drive or External Device

Before you connect your flash drive or external device, make sure the product is turned on but not printing.

**Note:** Epson cannot guarantee the compatibility of your drive.

1. Remove any memory cards from the product.
2. Load the paper you want to use for printing.

3. Insert your USB flash drive or the USB cable that came with your device into the  USB port on the front of your product.
4. Insert storage media (such as a CD) into your drive, if necessary.
5. Select the photos to print from the LCD screen.

When you finish printing, make sure the access light on the device is not flashing, then remove or disconnect it from the product.

**Caution:** Do not remove the USB device or turn off the product when the access light is flashing, or you may lose photos on the device.

**Parent topic:** [Viewing or Printing from a USB Flash Drive or External Device](#)

**Related tasks**

[Removing a Memory Card](#)

[Viewing and Printing Photos From the LCD Screen](#)

**Related topics**

[Loading Paper](#)

---

## Printing Personalized Projects

You can print calendars, lined paper, graph paper, or stationery with a photo background.

[Printing Coloring Book Pages](#)

[Printing Personalized Note Paper](#)

[Printing Lined Paper, Graph Paper, and Music Sheets](#)

[Printing Calendar Pages](#)

### Printing Coloring Book Pages

You can create a coloring book page from a photo on your memory card, or from a photo or drawing placed on the scanner glass.

1. Load one of these types of paper in either Letter (8.5 × 11 inches [216 × 279 mm]) or A4 (8.3 × 11.7 inches [210 × 297 mm]) size:
  - Plain paper
  - Epson Bright White Paper
  - Epson Presentation Paper Matte
  - Epson Premium Presentation Paper Matte
2. Insert a memory card or place a photo or drawing on the scanner glass.
3. Press the  home button, if necessary.
4. Press the arrow buttons to select **More Functions** and press the **OK** button.



5. Select **Coloring Book** and press the **OK** button.
6. Select one of the following settings:
  - **Photo or Drawing on Scanner Glass** to print a design from an original placed facedown on the scanner glass, in the front right corner
  - **Photo on Memory Card** to print a design from a memory card inserted in your product, then select a photo
7. Press the **OK** button twice.
8. Press the left or right arrow button to select the size and type of paper that you loaded.
9. Press the down arrow button to select **Paper Source** and select where you loaded your paper.
10. If necessary, adjust the following settings:
  - **Density** to make the print lighter or darker
  - **Line Detection** to change the amount of detail in the print
11. When you are ready to print, press the  start button.

**Note:** To cancel printing, press the  cancel button.

**Parent topic:** [Printing Personalized Projects](#)

**Related tasks**

[Placing Originals on the Scanner Glass](#)

[Inserting a Memory Card](#)

**Related topics**

[Loading Paper](#)

## Printing Personalized Note Paper

You can print lined or unlined note paper with one of your own photos in the background.

1. Load plain paper in either Letter (8.5 × 11 inches [216 × 279 mm]) or A4 (8.3 × 11.7 inches [210 × 297 mm]) size.
2. Insert a memory card into your product's memory card slot.
3. Press the  home button, if necessary.

4. Press the arrow buttons to select **More Functions** and press the **OK** button.



5. Select **Personal Stationery** and press the **OK** button.
6. Select **Writing Papers** and press the **OK** button.



7. Select one of the layout options and press the **OK** button.

**Note:** View the images for each option to preview the design layout.

8. Select the size of paper you loaded and press the **OK** button.

9. Select the photo you want to use for your note paper and press the **OK** button.

**Note:** To rotate the layout for your note paper, press the down arrow button.

10. When you see a message asking you to load paper, press the **OK** button.
11. To print more than one sheet, press the **+** or **-** button to select the number (up to 99).
12. When you are ready to print, press the **◇** start button.

**Note:** To cancel printing, press the **⊖** cancel button.

**Parent topic:** [Printing Personalized Projects](#)

**Related tasks**

[Inserting a Memory Card](#)

**Related topics**

[Loading Paper](#)

## Printing Lined Paper, Graph Paper, and Music Sheets

You can print music sheets and wide-rule or narrow-rule notebook paper and graph paper.

1. Load plain paper in either Letter (8.5 × 11 inches [216 × 279 mm]) or A4 (8.3 × 11.7 inches [210 × 297 mm]) size.
2. Press the **🏠** home button, if necessary.
3. Press the arrow buttons to select **More Functions** and press the **OK** button.



4. Select **Personal Stationery** and press the **OK** button.
5. Select **Lined Papers** and press the **OK** button.



6. Select one of the layout options and press the **OK** button.
- Note:** View the images for each option to preview the design layout.
7. Select the size of paper you loaded and press the **OK** button.
  8. When you see a message asking you to load paper, press the **OK** button.
  9. To print more than one sheet, press the **+** or **-** button to select the number (up to 99).
  10. When you are ready to print, press the **◇** start button.

**Note:** To cancel printing, press the **⊖** cancel button.

**Parent topic:** [Printing Personalized Projects](#)

**Related topics**

[Loading Paper](#)

## Printing Calendar Pages

You can create and print a weekly or monthly calendar page from your product.

1. Load plain paper in either Letter (8.5 × 11 inches [216 × 279 mm]) or A4 (8.3 × 11.7 inches [210 × 297 mm]) size.

2. Press the  home button, if necessary.
3. Select **More Functions** and press the **OK** button.



4. Select **Personal Stationery** and press the **OK** button.
5. Select **Calendar** and press the **OK** button.
6. Select one of the format options and press the **OK** button.

**Note:** View the images for each option to preview the design layout.

7. If you chose **Monthly**, select the year and month, and press the **OK** button.
8. Select the type of paper to print on and press the **OK** button.
9. When you see a message asking you to load paper, press the **OK** button.
10. To print more than one sheet, press the **+** or **-** button to select the number (up to 99).
11. When you are ready to print, press the  start button.

**Note:** To cancel printing, press the  cancel button.

**Parent topic:** [Printing Personalized Projects](#)

#### **Related topics**

[Loading Paper](#)

---

## Printing on CDs/DVDs

Follow the instructions in this section to print a design onto ink jet-printable CDs or DVDs to create a custom label.

[CD/DVD Printing Features](#)

[Loading a CD/DVD](#)

[Removing a Printed CD/DVD](#)

[Placing a CD/DVD on the Scanner Glass](#)

[Copying onto a CD/DVD](#)

[Printing Photos from a Memory Card Onto a CD/DVD](#)

[Printing a Jewel Case Insert from a Memory Card](#)

[Printing on CDs/DVDs from a Computer](#)

### CD/DVD Printing Features

You can use any of the following features to print custom CD/DVD/Blu-ray Disc labels and accessories:

- Copy an existing label onto a new CD/DVD/Blu-ray Disc
- Use your product's control panel to print photos from a memory card onto a CD/DVD/Blu-ray Disc
- Print text and images from your computer using the Epson Print CD software

**Parent topic:** [Printing on CDs/DVDs](#)

#### Related tasks

[Copying onto a CD/DVD](#)

[Printing Photos from a Memory Card Onto a CD/DVD](#)

[Printing a Jewel Case Insert from a Memory Card](#)

#### Related topics



[Printing on CDs/DVDs from a Computer](#)

### Loading a CD/DVD

You can print on any compatible, ink jet-printable CDs or DVDs, including Blu-ray Discs.

**Caution:** Do not insert the CD/DVD tray while the product is printing, copying, or performing other operations. Otherwise, your product may be damaged or the surface of the CD/DVD may become dirty or scratched.

**Note:** If you are using discs where the printable area extends to within 0.16 inch (4 mm) of the center hole, you may need to adjust the inner diameter setting using the control panel or Epson Print CD software.

1. Burn your files, music, or video onto your disc before printing on it.
2. Press the  home button, if necessary.
3. Press the  CD button, select **Load CD/DVD**, and press the **OK** button.
4. When you see a message asking if you want to prepare for CD loading, select **Yes** and press the **OK** button.
5. Raise the control panel all the way up.

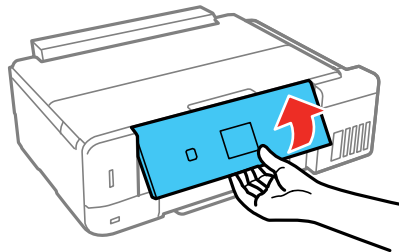

6. Make sure nothing is on the output tray, then close it.

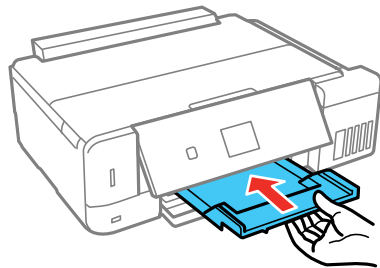

7. Close the front cover.

8. Remove the CD/DVD tray from the bottom of the product.

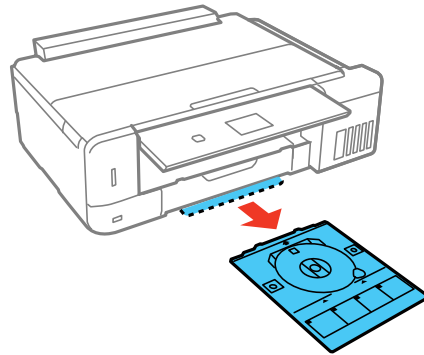

9. Place a CD or DVD on the CD/DVD tray with the printable side faceup, and insert the tray into the slot above the output tray.

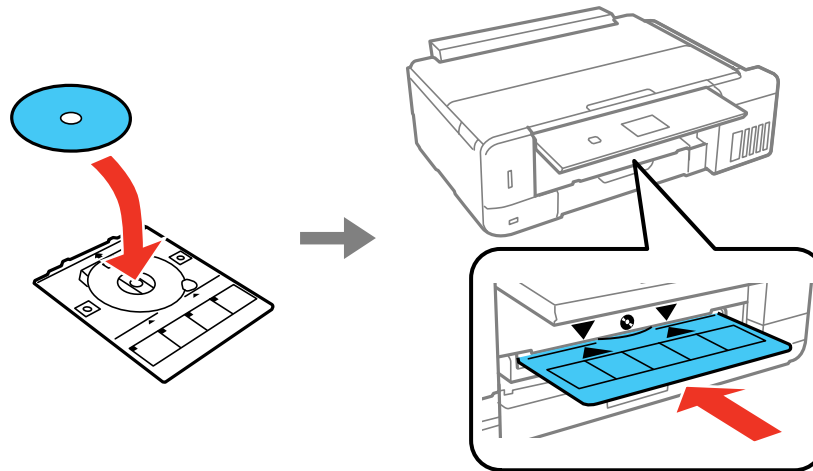

**Note:** Make sure the ▲ marks on the tray and the ▼ marks on the product line up.

10. Press the **OK** button.

**Caution:** Do not turn off the product with a CD or DVD loaded in it. Always remove the disc first.

Parent topic: [Printing on CDs/DVDs](#)

## Removing a Printed CD/DVD

After your CD or DVD is printed, the tray extends automatically.

1. Pull the CD/DVD tray out of the product and remove your CD or DVD from the tray.

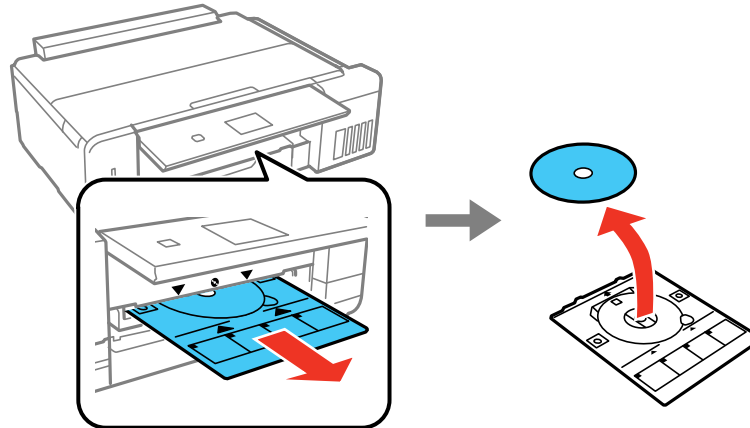

2. Insert the CD/DVD tray into the storage slot on the bottom of the product.

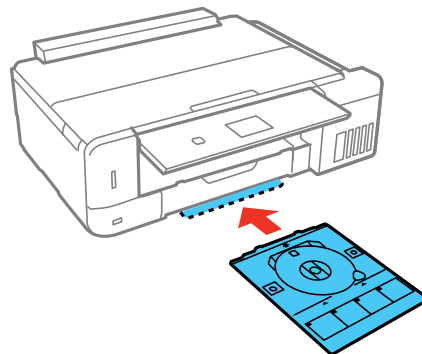

**Caution:** After printing, handle the CD or DVD carefully. You may need to wait up to 24 hours for the ink to dry fully before inserting it in a drive, depending on the type of disc you used. Keep printed discs away from moisture and direct sunlight.

Parent topic: [Printing on CDs/DVDs](#)

## Placing a CD/DVD on the Scanner Glass

You can place a CD or DVD on the scanner glass and copy the label design onto another CD or DVD.

1. Open the document cover.
2. Place your CD or DVD facedown in the center of the scanner glass.

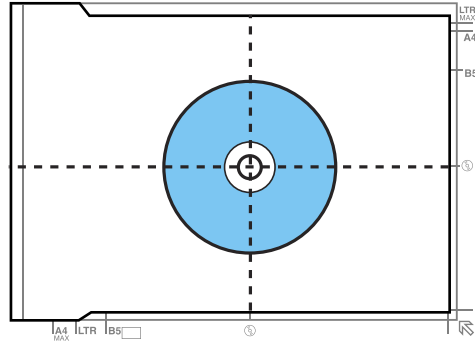



3. Close the document cover gently to keep your disc in place.

Parent topic: [Printing on CDs/DVDs](#)

## Copying onto a CD/DVD

You can copy a printed photo or CD/DVD label directly onto an ink jet-printable CD or DVD. If you want, you can first print a test design on plain paper.

1. Load the CD, DVD, or plain paper you want to print on.
2. Press the  home button, if necessary.
3. Press the  CD button.
4. Select **CD/DVD Copy** and press the **OK** button.
5. Follow the instructions on the LCD screen to place your original CD, DVD, or photo on the scanner glass and press the **OK** button.
6. If necessary, adjust the inner and outer diameter of your CD as shown on the screen, and press the **OK** button.

You see this screen:

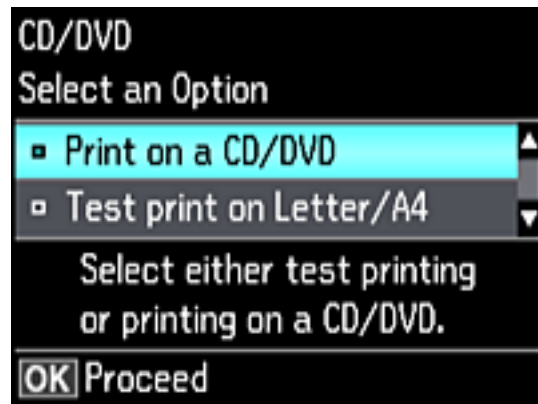

7. Select one of the options shown on the screen and press the **OK** button. If printing a test print on plain paper, press the **OK** button again.
8. Select any copy settings as needed.
9. When you are ready to print, press the  $\diamond$  start button.

**Note:** To cancel printing, press the  $\odot$  cancel button.

**Parent topic:** [Printing on CDs/DVDs](#)

**Related tasks**

[Loading a CD/DVD](#)

[Placing a CD/DVD on the Scanner Glass](#)

[Placing Originals on the Scanner Glass](#)

## Printing Photos from a Memory Card Onto a CD/DVD

You can print one or more photos from a memory card directly onto a CD/DVD. If you want, you can first print a test design on plain paper.

1. Insert a memory card into a memory card slot on your product.
2. Load the CD, DVD, or plain paper you want to print on.
3. Press the  $\uparrow$  home button, if necessary.

4. Press the  CD button.
5. Select **Print on CD/DVD** and press the **OK** button.

You see this screen:



6. Select one of the layout options and press the **OK** button.
7. Follow the instructions on the screen to select your photo or photos.
8. When you see the screen to adjust the inner and outer diameter of your CD or DVD, adjust the settings if necessary, and press the **OK** button.

You see this screen:

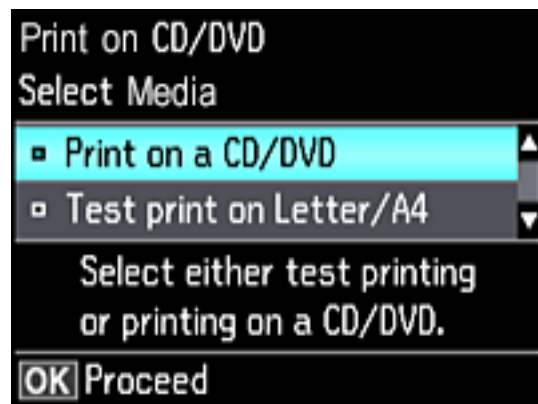

9. Select one of the options shown on the screen and press the **OK** button. If printing a test print on plain paper, press the **OK** button again.
10. When you are ready to print, press the  start button.

**Note:** To cancel printing, press the  cancel button.

**Parent topic:** [Printing on CDs/DVDs](#)

**Related tasks**

[Inserting a Memory Card](#)

[Loading a CD/DVD](#)

## Printing a Jewel Case Insert from a Memory Card

You can print a photo from a memory card on a CD/DVD jewel case insert. Your product automatically resizes the photo to fit, but you can also print multiple thumbnail images formatted to fit on a jewel case insert. After the insert is printed, you can cut and fold it to fit.

1. Insert a memory card into a memory card slot on your product.
2. Load the paper you want to print on.
3. Press the  home button, if necessary.
4. Press the arrow buttons to select **More Functions** and press the **OK** button.



5. Select **Photo Layout Sheet** and press the **OK** button.

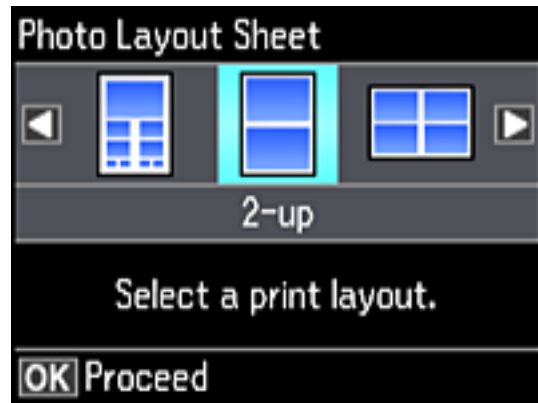

6. Select one of the following options and press the **OK** button:
  - **Jewel Upper** to print one photo on the upper half of the insert.
  - **Jewel Index** to print 24 or 48 thumbnail images on the insert.
7. Select your paper size and type, and press the **OK** button.
8. Follow the instructions on the LCD display to select your photos and set the number of copies.
9. When you are ready to print, press the  start button.

**Note:** To cancel printing, press the  cancel button.

10. After your insert is printed, cut and fold it following the crop lines.

**Parent topic:** [Printing on CDs/DVDs](#)

**Related tasks**

[Inserting a Memory Card](#)

**Related topics**

[Loading Paper](#)

## Printing on CDs/DVDs from a Computer

Before printing directly on CDs or DVDs from your computer, make sure you have set up your product as described on the *Start Here* sheet and installed the Epson Print CD software.

**Note:** If you are using your Epson product with the Windows 10 S operating system, you cannot use the software described in this section. You also cannot download and install any Epson product software from the Epson website for use with Windows 10 S; you must obtain software only from the Windows Store.

[Starting Epson Print CD - Windows](#)

[Printing Your CD/DVD Design - Windows](#)

[Starting Epson Print CD - Mac](#)

[Printing Your CD/DVD Design - Mac](#)

**Parent topic:** [Printing on CDs/DVDs](#)

## Starting Epson Print CD - Windows

You can use Epson Print CD to design your disc by importing photos, adding text, and creating special effects.

1. Select the Epson Print CD icon on your Windows Desktop.

You see a screen like this:

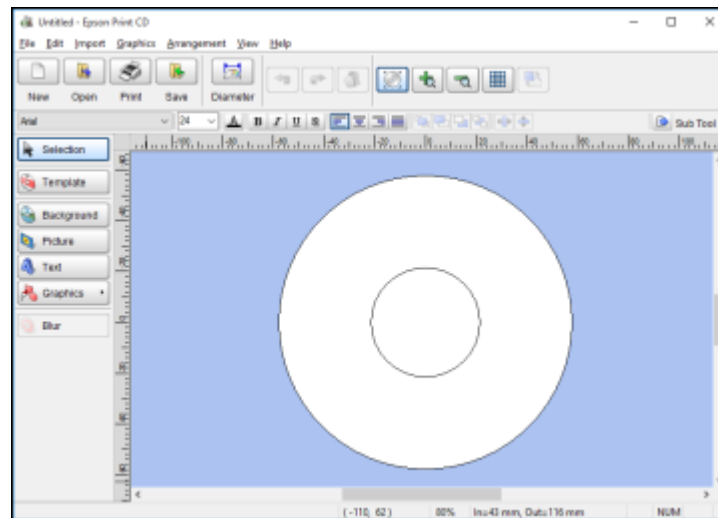

2. Use the buttons on the left side of the screen to select a pre-designed template or add a background image, picture, text, or graphic elements. For more information, select the **Help** menu.

3. When you are finished creating your design, click **Save** and save your design file.

**Parent topic:** [Printing on CDs/DVDs from a Computer](#)

### Related tasks

[Printing Your CD/DVD Design - Windows](#)

## Printing Your CD/DVD Design - Windows

After you create your design, you can print it on paper to test it, then print it on the CD or DVD that contains your data, photos, video, or music. Make sure the disc is loaded for printing before you start.

1. Open your file in Epson Print CD and click **Print**.

You see a screen like this:

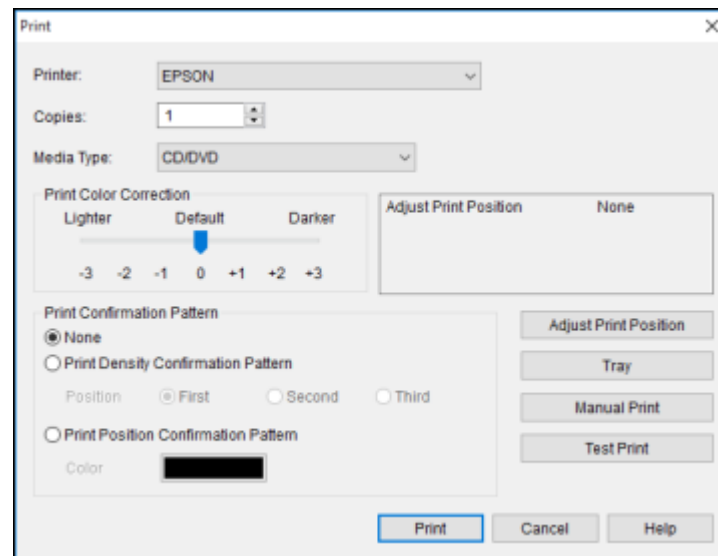

2. Make sure your product is selected as the **Printer** setting.
3. To see how your design will look without printing on the disc, click **Test Print** and follow the instructions on the screen.
4. When you are ready to print on the disc, click the **Print** button on the screen.
5. Click **Print**.

**Note:** If you need to adjust the print position or print quality, see the Epson Print CD Help utility for instructions.

**Parent topic:** [Printing on CDs/DVDs from a Computer](#)

**Related tasks**

[Starting Epson Print CD - Windows](#)

## Starting Epson Print CD - Mac

You can use Epson Print CD to design your disc by importing photos, adding text, and creating special effects.

1. Open the Epson Print CD program in the **Applications > Epson Software > Print CD** folder on your Mac.

You see a screen like this:

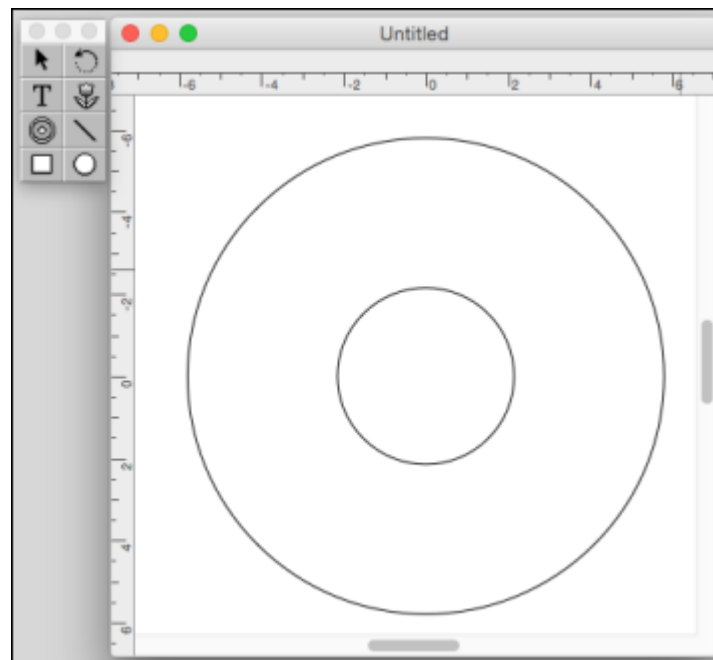

2. Use the icons on the left side of the screen to add a background image, picture, text, or graphic elements.

3. When you are finished creating your design, make sure you save it.

**Parent topic:** [Printing on CDs/DVDs from a Computer](#)

### Related tasks

[Printing Your CD/DVD Design - Mac](#)

## Printing Your CD/DVD Design - Mac

After you create your design, you can print it on paper to test it, then print it on the CD or DVD that contains your data, photos, video, or music. Make sure the disc is loaded for printing before you start.

1. Open your file in Epson Print CD and select **Print** from the File menu.

You see a screen like this:

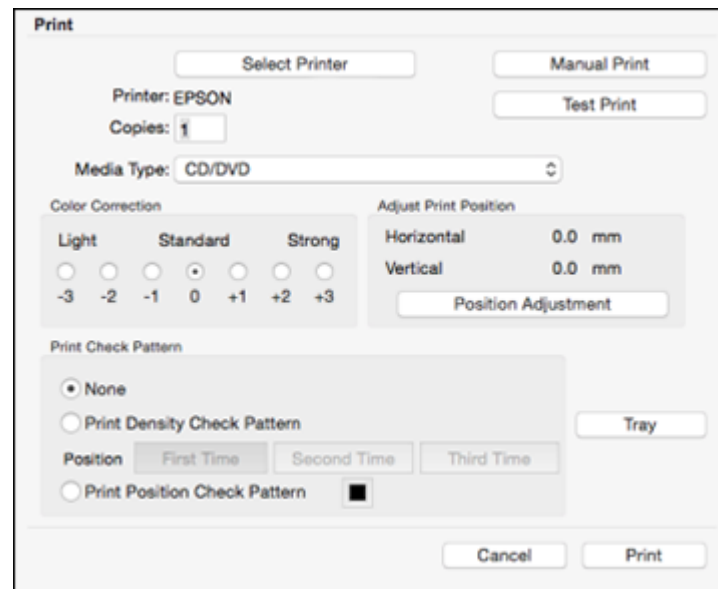

2. Make sure your product is selected as the **Printer** setting.
3. To see how your design will look without printing on the disc, select **Test Print** and follow the instructions on the screen.
4. When you are ready to print on the disc, click the **Print** button on the screen.

**Note:** If you need to adjust the print position or print quality, see the Epson Print CD Help utility for instructions.

**Parent topic:** [Printing on CDs/DVDs from a Computer](#)

**Related tasks**

[Starting Epson Print CD - Mac](#)

---

## Refilling Ink

When the ink level is below the lower line on an ink tank, you need to refill it.

Before checking the ink level or refilling an ink tank as described here, be sure to read the ink safety precautions.

**Caution:** If the ink level is below the lower line on the ink tank, fill it to the upper line on the ink tank. Continued use of the product when the ink level is below the lower line on the tank could damage the product.

[Ink Safety Precautions](#)

[Check Ink Levels](#)

[Purchase Epson Ink and Maintenance Box](#)

[Refilling the Ink Tanks](#)

[Replacing the Maintenance Box](#)

## Ink Safety Precautions

**Note:** The product has a low ink alert system. The accuracy of this system depends on the user refilling the ink tanks correctly. The product cannot directly measure the ink levels in the tanks; instead it estimates the amount of ink remaining by internally monitoring ink usage. The low ink alert system may generate inaccurate messages if the ink tanks are not refilled according to these instructions.

As a precaution, perform regular visual inspections of the ink tanks to ensure ink levels do not fall below the lower line. Continued use of the product when the ink level is below the lower line on the tank could damage the product.

### Ink Handling Precautions

- Keep ink bottles and the ink tank unit out of the reach of children. Do not allow children to drink from or handle the ink bottles and bottle caps.
- Do not tilt or shake an ink bottle after opening it; otherwise, ink may leak.
- If ink gets on your skin, wash it thoroughly with soap and water. If ink gets into your eyes, flush them immediately with water. If ink gets into your mouth, spit it out immediately. Seek medical advice if problems persist.
- Do not squeeze the ink bottles.

## **Ink Refilling Precautions**

- Use ink bottles with the correct part number for this product.
- Do not mix with other Epson ink types.
- The use of non-Epson ink may cause damage that is not covered by Epson's warranty, and under certain circumstances, may cause erratic product behavior.
- This product requires careful handling of ink. Ink may splatter when the ink tanks are filled or refilled with ink. If ink gets on your clothes or belongings, it may not come off.
- Do not open the ink bottle package until you are ready to fill an ink tank. Ink bottles are vacuum packed to maintain reliability. If you leave an ink bottle unpacked for a long time before using it, print quality may be affected.
- If the ink level is below the lower line on the ink tank, refill the ink. Continued use of the product when the ink level is below the lower line on the ink tank could damage the product.
- Epson recommends filling an ink tank to the upper line before resetting the ink level.
- After bringing an ink bottle inside from a cold storage site, allow it to warm up at room temperature for at least three hours before using it.
- Store ink bottles in a cool, dark place.
- Store the ink bottles in the same environment as the product. When storing or transporting an opened ink bottle, do not tilt the bottle and do not subject it to impacts or temperature changes. Otherwise, ink may leak even if the cap on the ink bottle is tightened securely. Be sure to keep the ink bottle upright when tightening the cap, and take measures to prevent ink from leaking when you transport the bottle.

## **Ink Bottle and Ink Tank Information**

- To maintain optimum print head performance, some ink is consumed from all ink tanks during printing and when performing maintenance operations, such as cleaning the print head.
- The ink bottles may contain recycled materials, but this does not affect product function or performance.
- When printing in monochrome or grayscale, color ink may be used instead of black ink, depending on the paper type or print quality settings. This is because a mixture of color inks is used to create black.

**Parent topic:** [Refilling Ink](#)

## **Check Ink Levels**

Your product and its printing software will let you know when an ink tank is low or expended.

[Checking Ink Levels on Your Product](#)

[Checking Ink Levels with Windows](#)  
[Checking Ink Levels - Mac](#)  
[Disabling Special Offers with Windows](#)

**Parent topic:** [Refilling Ink](#)

## Checking Ink Levels on Your Product

To confirm the actual ink levels, visually check the ink levels in the product's ink tanks. Make sure the ink levels are above the lower lines on the ink tanks.

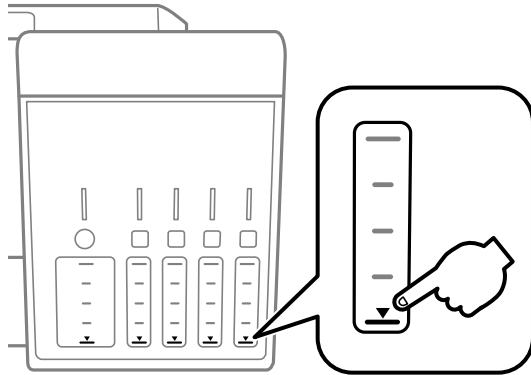



**Note:** The product has a low ink alert system. The accuracy of this system depends on the user refilling the ink tanks correctly. The product cannot directly measure the ink levels in the tanks; instead it estimates the amount of ink remaining by internally monitoring ink usage. The low ink alert system may generate inaccurate messages if the ink tanks are not refilled according to these instructions.

As a precaution, perform regular visual inspections of the ink tanks to ensure ink levels do not fall below the lower line. Continued use of the product when the ink level is below the lower line on the tank could damage the product.

**Parent topic:** [Check Ink Levels](#)

## Checking Ink Levels with Windows

A low ink reminder appears if you try to print when ink is low, and you can check your ink levels at any time using a utility on your Windows computer.

1. To check your ink levels, access the Windows Desktop and double-click the  icon for your product in the right side of the Windows taskbar, or click the up arrow and double-click .

You see a window like this:



2. Refill any ink tank as needed.

**Note:** The ink levels displayed are an estimate and may differ from the actual ink remaining in the ink tanks. To confirm the actual remaining ink, visually check the ink levels in the ink tanks. Continued use of the product when the ink level is below the lower line on the tank could damage the product.

**Parent topic:** [Check Ink Levels](#)

**Related references**

[Ink Safety Precautions](#)

**Related topics**

[Refilling Ink](#)

## Checking Ink Levels - Mac

You can check your ink levels using a utility on your Mac.

1. In the Apple menu or the Dock, select **System Preferences**. Select **Print & Fax**, **Print & Scan**, or **Printers & Scanners**, select your product, and select **Options & Supplies**. Select **Utility** and select **Open Printer Utility**.
2. Select **EPSON Status Monitor**.

You see a window like this:

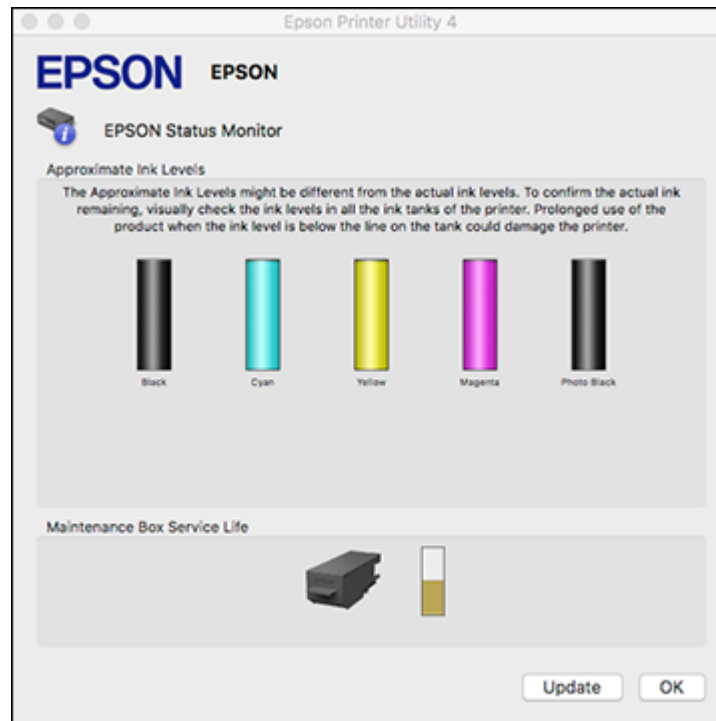

3. Refill any ink tank as needed.

**Note:** To update or refresh the displayed ink levels, click **Update**.

**Note:** The ink levels displayed are an estimate and may differ from the actual ink remaining in the ink tanks. To confirm the actual remaining ink, visually check the ink levels in the ink tanks. Continued use of the product when the ink level is below the lower line on the tank could damage the product.

**Parent topic:** [Check Ink Levels](#)

**Related references**



[Ink Safety Precautions](#)

## Related topics

[Refilling Ink](#)

## Disabling Special Offers with Windows

You can disable special offers messages from Epson using a utility on your Windows computer.

1. Access the Windows Desktop and right-click the  icon for your product in the right side of the Windows taskbar, or click the up arrow and right-click . Select **Monitoring Preferences**.

You see this window:

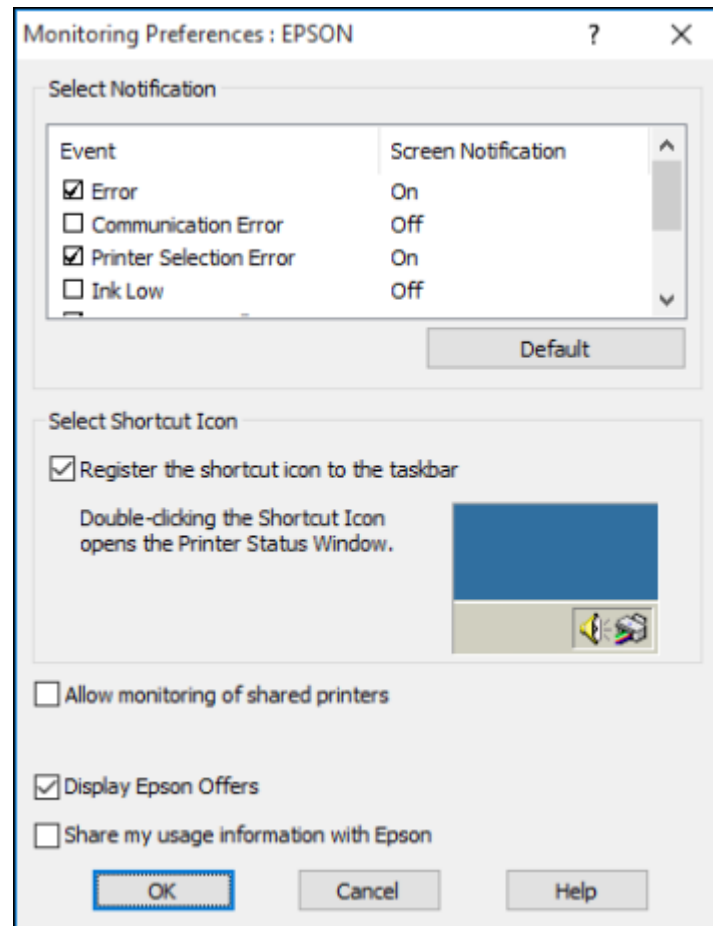

2. To disable promotional offers, deselect the **Display Epson Offers** checkbox.

**Parent topic:** [Check Ink Levels](#)

## Purchase Epson Ink and Maintenance Box

You can purchase genuine Epson ink, maintenance boxes, and paper at [epson.com](http://epson.com) (U.S. sales) or [epson.ca](http://epson.ca) (Canadian sales). You can also purchase supplies from an Epson authorized reseller. To find the nearest one, call 800-GO-EPSON (800-463-7766) in the U.S. or 800-807-7766 in Canada.

**Note:** This product is designed to work with genuine Epson inks. Non-Epson ink or any other ink not specified for this printer could cause damage not covered by Epson's warranties.

The included initial ink bottles must be used for printer setup and are not for resale. The printer ships with full ink bottles and part of the ink from the first bottles is used to charge the print head. Yields vary considerably based on images printed, print settings, paper type, frequency of use and temperature.

[Ink Bottle and Maintenance Box Part Numbers](#)

**Parent topic:** [Refilling Ink](#)

## Ink Bottle and Maintenance Box Part Numbers

Use these part numbers when you order or purchase new ink bottles or a new maintenance box. Use the ink by the date printed on the package.

Ink color	Part number
Black	512
Cyan	512
Magenta	512
Yellow	512
Photo Black	512

**Maintenance box part number:** T04D000

**Parent topic:** [Purchase Epson Ink and Maintenance Box](#)

## Refilling the Ink Tanks

Make sure you have new ink bottles handy and have read the ink safety precautions before you begin.

You can continue to use the product even if one or more ink tanks are not filled all the way. However, for the most accurate ink level monitoring, fill all the ink tanks up to the top line.

**Note:** The product has a low ink alert system. The accuracy of this system depends on the user refilling the ink tanks correctly. The product cannot directly measure the ink levels in the tanks; instead it estimates the amount of ink remaining by internally monitoring ink usage. The low ink alert system may generate inaccurate messages if the ink tanks are not refilled according to these instructions.

As a precaution, perform regular visual inspections of the ink tanks to ensure ink levels do not fall below the lower line. Continued use of the product when the ink level is below the lower line on the tank could damage the product.

**Caution:** Wear disposable gloves while refilling the ink tanks to avoid staining your hands. If ink spills, wipe it off immediately with a damp towel to avoid permanent stains. If ink gets on your clothes or belongings, it may not come off.

1. Turn on your product.
2. Lift up the scanner unit.

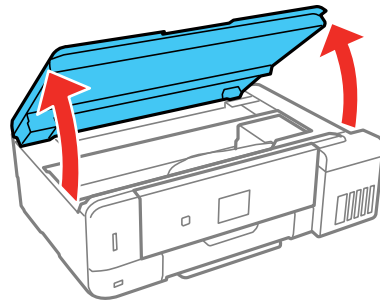

3. Open the ink tank cover, then open the cap for the ink tank you are going to fill.

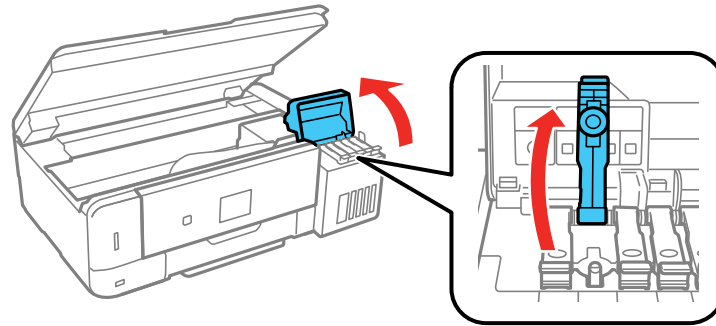

4. Hold the ink bottle upright and slowly turn the bottle cap to remove it.

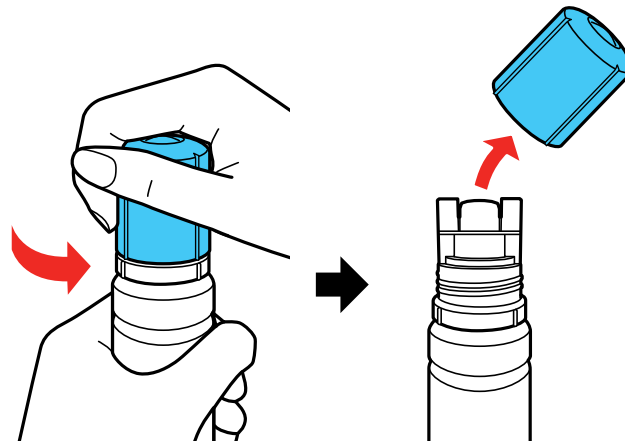

**Caution:** Do not shake or squeeze the bottle. Do not touch the top of the bottle after its cap is removed.

**Warning:** If ink gets on your skin, wash it thoroughly with soap and water. If ink gets into your eyes, flush them immediately with water. If ink gets into your mouth, spit it out immediately. Seek medical advice if problems persist. Keep the ink bottles out of the reach of children and do not drink the ink.

5. Position the top of the ink bottle along the slot in front of the filling port, then slowly stand the bottle up to insert it.

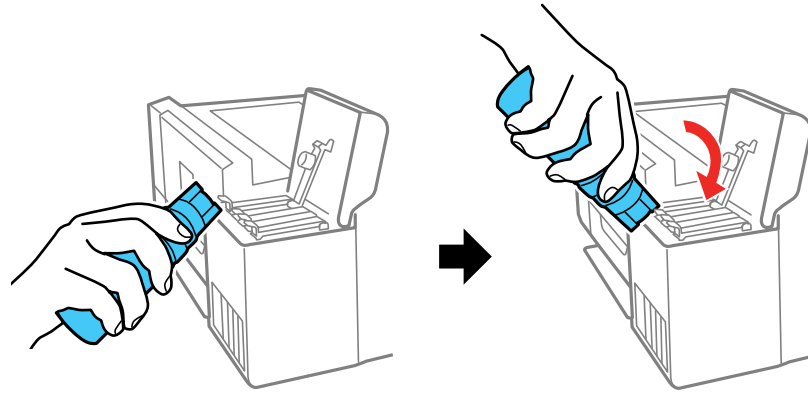

**Note:** Refer to the color-coded sticker on the ink tank unit to identify the color of each tank. Do not force the bottles into position; they are keyed for each color.

6. Wait for the ink to fill the tank. Do not squeeze the bottle. Ink flows into the tank and stops automatically when the ink is filled to the upper line.

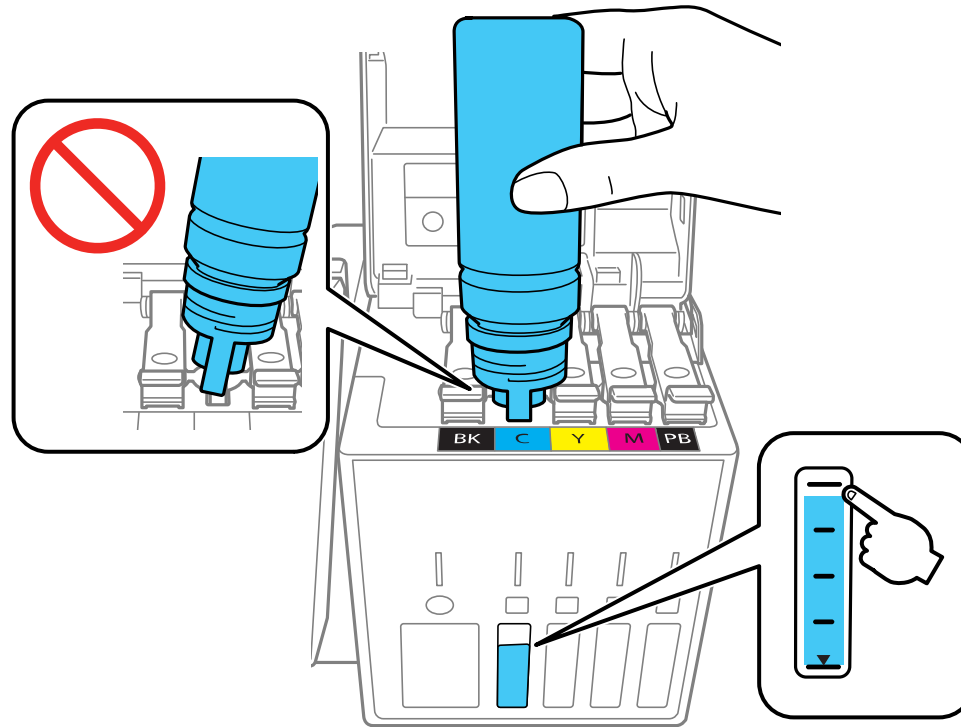

**Note:** If ink does not flow from the bottle, lift and reinsert the bottle.

7. When the ink tank is full, remove the ink bottle and securely close the ink tank cap.

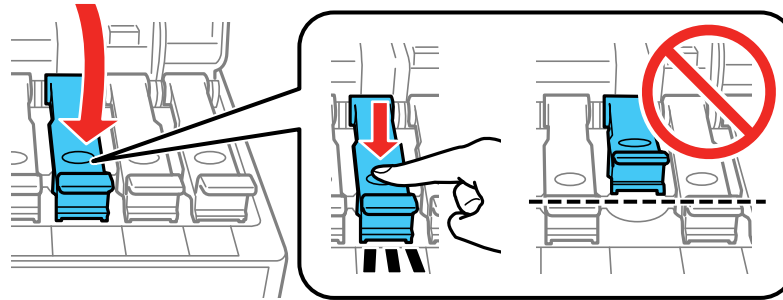

**Note:** If any ink remains in the bottle, replace the bottle cap and tighten it. Store the bottle upright for later use.

8. Repeat the previous steps as necessary for each ink tank you need to refill.
9. Close the ink tank cover, then close the scanner unit.

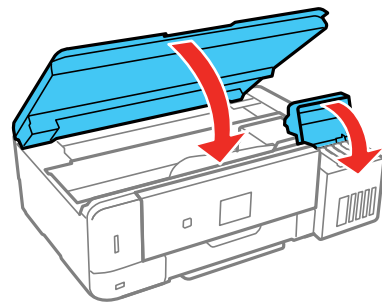

10. Press the **OK** button on the product control panel to proceed. Follow the on-screen instructions to reset the ink level for the color you refilled.

**Parent topic:** [Refilling Ink](#)

**Related concepts**

[Purchase Epson Ink and Maintenance Box](#)

## Replacing the Maintenance Box

Make sure you have a new maintenance box before you begin.

**Caution:** Do not reuse a maintenance box that has been removed and left uninstalled for more than a week. Keep the maintenance box away from direct sunlight.

1. Remove the new maintenance box from its package.

**Caution:** Do not touch the green chip on the maintenance box. Doing so may prevent normal operation and printing.

2. Using a flat-tipped screwdriver, remove the screw on the maintenance box cover and remove the cover.

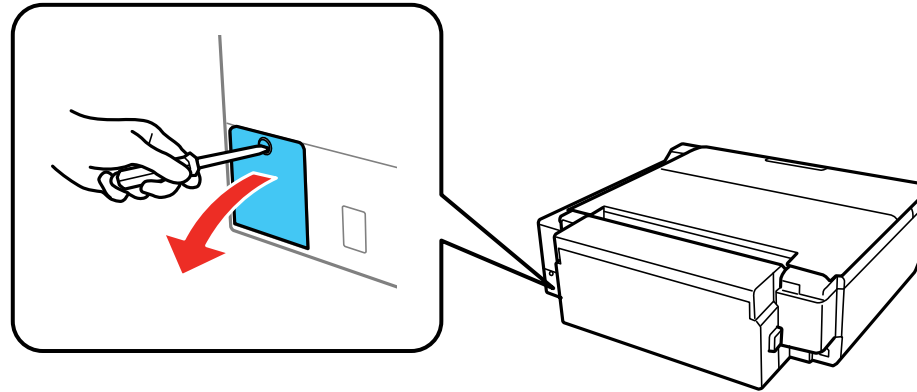

3. Remove the used maintenance box.

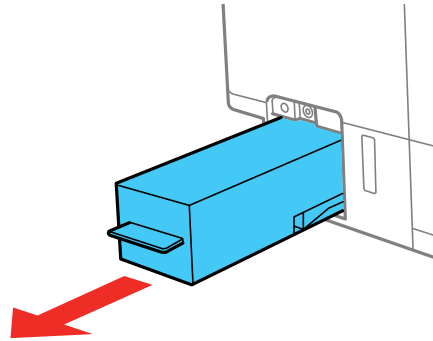

**Note:** Do not tilt the used maintenance box or take it apart.

**Caution:** Do not touch the areas shown below on the maintenance box; otherwise, ink may leak.

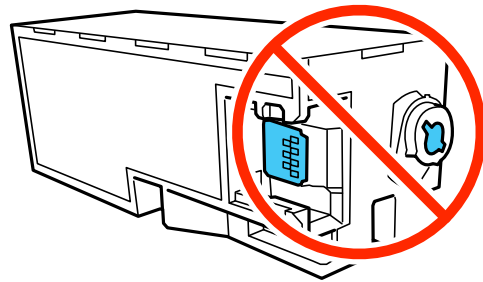

**Warning:** If ink gets on your skin, wash it thoroughly with soap and water. If ink gets into your eyes, flush them immediately with water. If ink gets into your mouth, spit it out immediately. Keep the maintenance box out of the reach of children and do not drink the ink.

4. Place the used maintenance box in the plastic bag that came with the new maintenance box. Seal the bag and dispose of it carefully.

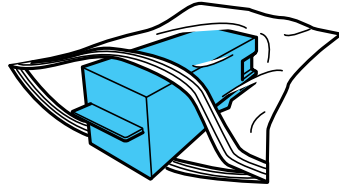

5. Insert the new maintenance box and push it all the way in.

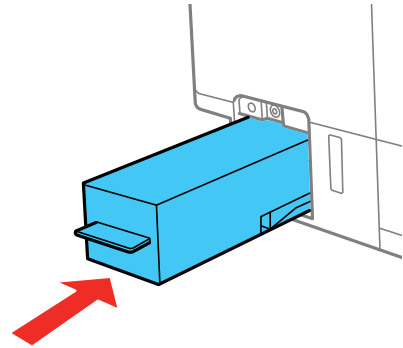

6. Reattach the maintenance box cover and tighten the screw.

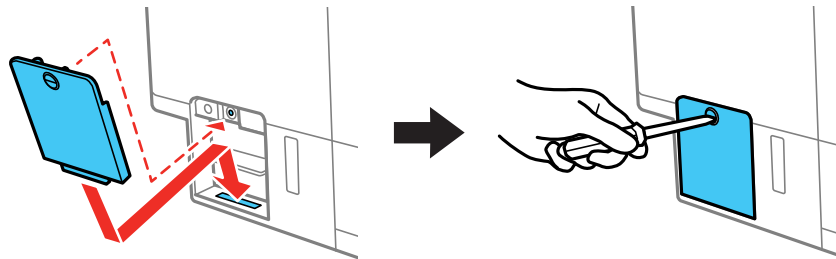

7. Press the **OK** button on the product control panel to resume operation.

Parent topic: [Refilling Ink](#)

**Related references**

[Ink Bottle and Maintenance Box Part Numbers](#)

---

## Adjusting Print Quality

If your print quality declines, you may need to run a utility to clean or align the print head.

If running these utilities does not solve the problem, you may need to run a Power Cleaning or clean the paper or printer head path.

[Print Head Maintenance](#)

[Print Head Alignment](#)

[Cleaning the Paper Path](#)

[Cleaning the Rear Paper Feed Path Using the Cleaning Sheet](#)

[Cleaning the Printer Head Path](#)

[Checking the Number of Sheets](#)

### Print Head Maintenance

If your printouts become too light, or you see dark or light bands across them, you may need to clean the print head nozzles. Cleaning uses ink, so clean the nozzles only if print quality declines.

You can check for clogged nozzles before you clean them so you don't clean them unnecessarily.

**Note:** You cannot clean the print head if the ink level has reached the lower line on the ink tank, and may not be able to clean it when the ink level in any of the tanks is low. You must refill the ink tank first.

If you still see white or dark lines or missing nozzles in your printouts, even after cleaning the print head several times, you can run a Power Cleaning.

[Print Head Nozzle Check](#)

[Print Head Cleaning](#)

[Power Cleaning](#)

**Parent topic:** [Adjusting Print Quality](#)

**Related topics**

[Refilling Ink](#)

### Print Head Nozzle Check

You can print a nozzle check pattern to check for clogged nozzles.

[Checking the Nozzles Using the Product Control Panel](#)

[Checking the Nozzles Using a Computer Utility](#)

Parent topic: [Print Head Maintenance](#)

### Checking the Nozzles Using the Product Control Panel

You can check the print head nozzles using the control panel on your product.

1. Make sure there are no errors on the LCD screen, the CD/DVD tray is not inserted for printing, and the output tray is extended.
2. Load a few sheets of plain paper in the product.
3. Press the  home button, if necessary.
4. Press the arrow buttons to select **Settings** and press the **OK** button.
5. Select **Maintenance** and press the **OK** button.

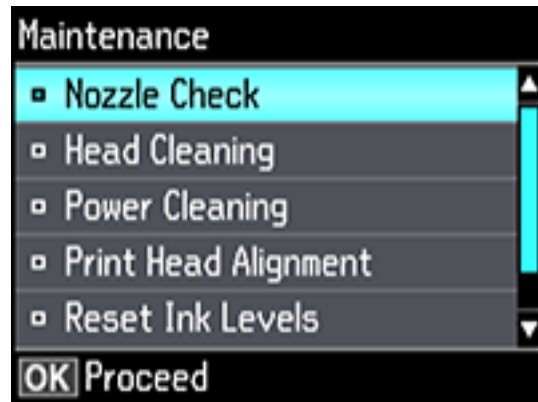

6. Press the **OK** button to select **Nozzle Check**.

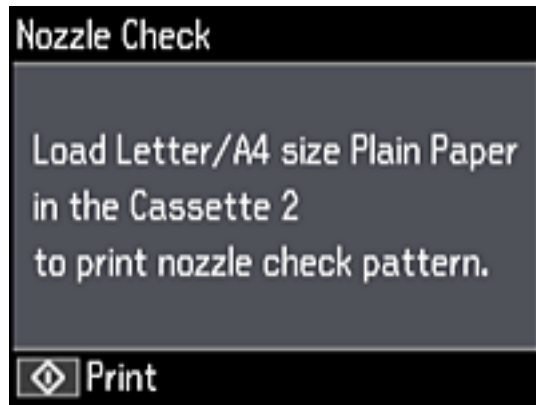

7. Press the  start button.  
The nozzle check pattern is printed.
8. Check the printed pattern to see if there are gaps in the lines.

**Print head is clean**

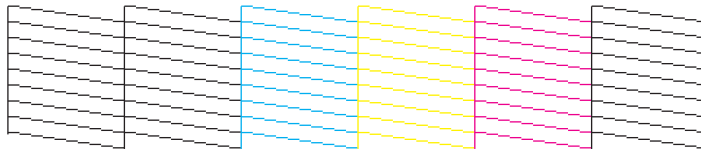

**Print head needs cleaning**

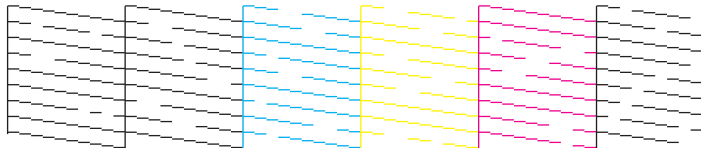

9. Do one of the following:
  - If there are no gaps, the print head is clean. Press the up arrow button to select **OK**.
  - If there are gaps or the pattern is faint, press the down arrow button to select **NG**. Follow the instructions on the screen to clean the print head.

If you don't see any improvement after cleaning the print head up to 3 times, turn the product off and wait at least 12 hours. Then try cleaning the print head again. If quality still does not improve, run a Power Cleaning. If there is still no improvement, contact Epson support.

**Parent topic:** [Print Head Nozzle Check](#)

#### **Related tasks**

[Cleaning the Print Head Using the Product Control Panel](#)

[Power Cleaning Using the Product Control Panel](#)



[Checking the Nozzles Using a Computer Utility](#)

#### **Related topics**

[Loading Paper](#)

### **Checking the Nozzles Using a Computer Utility**

You can check the print head nozzles using a utility on your Windows or Mac computer.

1. Make sure there are no errors on the LCD screen, the CD/DVD tray is not inserted for printing, and the output tray is extended.
2. Load a few sheets of plain paper in the product.
3. Do one of the following:
  - **Windows:** Access the Windows Desktop and right-click the  icon for your product in the right side of the Windows taskbar, or click the up arrow and right-click .
  - **Mac:** In the Apple menu or the Dock, select **System Preferences**. Select **Print & Fax**, **Print & Scan**, or **Printers & Scanners**, select your product, and select **Options & Supplies**. Select **Utility** and select **Open Printer Utility**.
4. Select **Nozzle Check**.

You see a window like this:

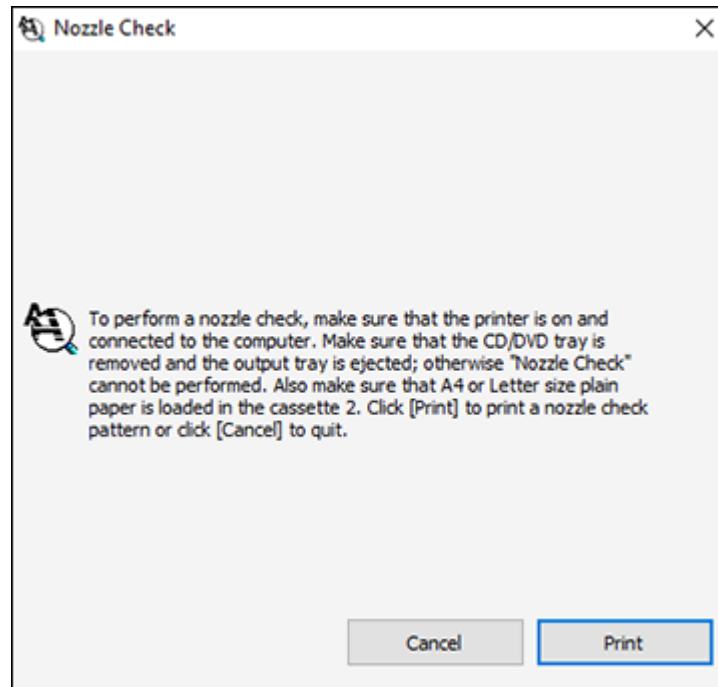

5. Click **Print**.

6. Check the printed pattern to see if there are gaps in the lines.

#### **Print head is clean**

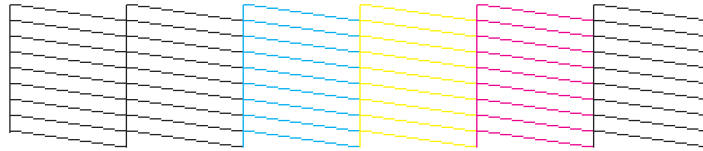

#### **Print head needs cleaning**

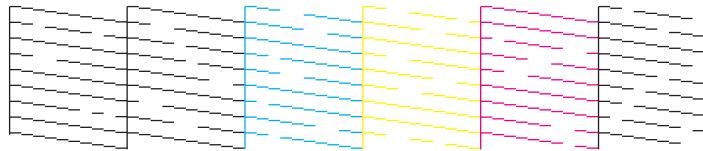

7. If there are no gaps, click **Finish**.

If there are gaps or the pattern is faint, clean the print head.

If you don't see any improvement after cleaning the print head up to 3 times, turn the product off and wait at least 12 hours. Then try cleaning the print head again. If quality still does not improve, run a Power Cleaning. If there is still no improvement, contact Epson support.

**Parent topic:** [Print Head Nozzle Check](#)

#### **Related tasks**

[Cleaning the Print Head Using a Computer Utility](#)

[Power Cleaning Using a Computer Utility](#)

[Checking the Nozzles Using the Product Control Panel](#)

#### **Related topics**

[Loading Paper](#)

## **Print Head Cleaning**

If print quality has declined and the nozzle check pattern indicates clogged nozzles, you can clean the print head.

**Note:** You cannot clean the print head if the ink level has reached the lower line on the ink tank, and may not be able to clean it when the ink level in any of the tanks is low. You must refill the ink tank first.

[Cleaning the Print Head Using the Product Control Panel](#)

[Cleaning the Print Head Using a Computer Utility](#)

**Parent topic:** [Print Head Maintenance](#)

### **Cleaning the Print Head Using the Product Control Panel**

You can clean the print head nozzles using the control panel on your product.

1. Make sure there are no errors on the LCD screen, the CD/DVD tray is not inserted for printing, and the output tray is extended.
2. Load a few sheets of plain paper in the product.
3. Press the  home button, if necessary.
4. Press the arrow buttons to select **Settings** and press the **OK** button.
5. Select **Maintenance** and press the **OK** button.

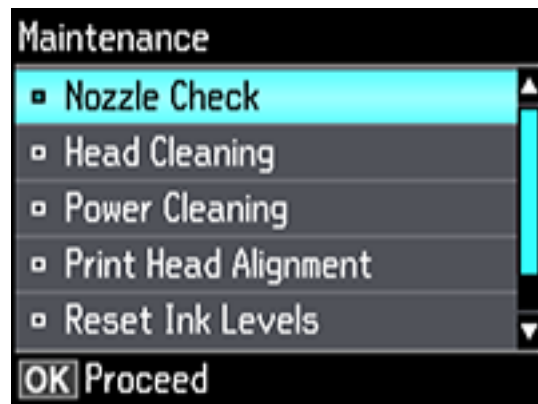

6. Select **Head Cleaning** and press the **OK** button.

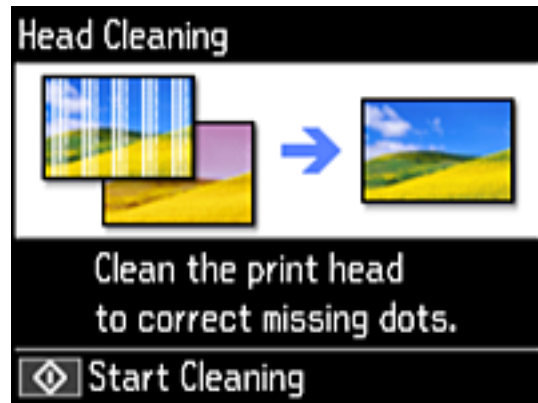

7. Press the  start button to clean the print head. You see a message on the LCD screen during the cleaning cycle.

**Caution:** Never turn off the product during a cleaning cycle or you may damage it.

When the cleaning cycle is finished, you see a completion message on the LCD screen.

8. Select **Check** and press the **OK** button.
9. Press the  start button to print a nozzle check pattern and confirm that the print head is clean.

If you don't see any improvement after cleaning the print head up to 3 times, turn off the product and wait at least 12 hours. Then try cleaning the print head again. If quality still does not improve, run a Power Cleaning. If there is still no improvement, contact Epson support.

**Parent topic:** [Print Head Cleaning](#)

#### **Related tasks**

[Checking the Nozzles Using the Product Control Panel](#)

[Power Cleaning Using the Product Control Panel](#)



[Cleaning the Print Head Using a Computer Utility](#)

#### **Related topics**

[Loading Paper](#)

## Cleaning the Print Head Using a Computer Utility

You can clean the print head using a utility on your Windows or Mac computer.

1. Make sure there are no errors on the LCD screen, the CD/DVD tray is not inserted for printing, and the output tray is extended.
2. Load a few sheets of plain paper in the product.
3. Do one of the following:
  - **Windows:** Access the Windows Desktop and right-click the  icon for your product in the right side of the Windows taskbar, or click the up arrow and right-click .
  - **Mac:** In the Apple menu or the Dock, select **System Preferences**. Select **Print & Fax**, **Print & Scan**, or **Printers & Scanners**, select your product, and select **Options & Supplies**. Select **Utility** and select **Open Printer Utility**.
4. Select **Head Cleaning**.

You see a window like this:

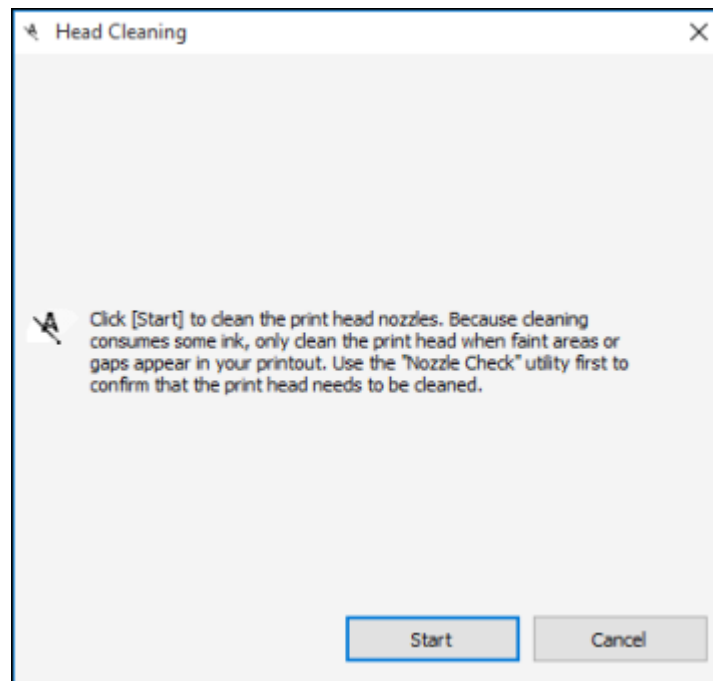

5. Click **Start** to begin the cleaning cycle.

**Caution:** Never turn off the product during a cleaning cycle or you may damage it.

6. When the cleaning cycle is finished, you can check to see if the nozzles are clean; click **Print Nozzle Check Pattern** and click **Print**.
7. Check the printed pattern to see if there are gaps in the lines.

#### **Print head is clean**

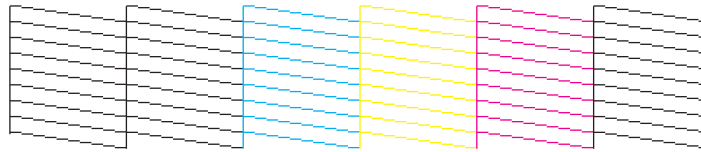

#### **Print head needs cleaning**

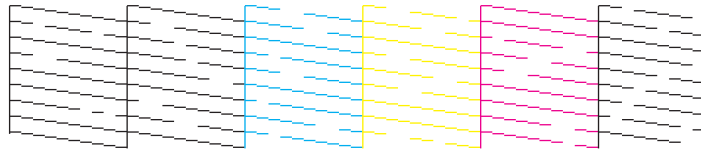

- If there are no gaps, click **Finish**.
- If there are gaps or the pattern is faint, click **Clean** to clean the print head again.

If you don't see any improvement after cleaning the print head up to 3 times, turn off the product and wait at least 12 hours. Then try cleaning the print head again. If quality still does not improve, run a Power Cleaning. If there is still no improvement, contact Epson support.

**Parent topic:** [Print Head Cleaning](#)

#### **Related tasks**

[Checking the Nozzles Using a Computer Utility](#)

[Power Cleaning Using a Computer Utility](#)

[Cleaning the Print Head Using the Product Control Panel](#)

## Related topics

[Loading Paper](#)

## Power Cleaning

If you still see white or dark lines or missing nozzles in your printouts, even after cleaning the print head several times, you can run a Power Cleaning.

If you do not see improvement after running a Power Cleaning, turn off the product and wait at least 12 hours before running another Power Cleaning.

**Caution:** Running a Power Cleaning consumes a lot of ink, so you should run it only if necessary. Make sure each ink tank is at least one-third full before running a Power Cleaning, or it may damage the product.

**Caution:** Power Cleaning may cause the ink pads to reach their capacity sooner. When an ink pad reaches the end of its service life, the product stops printing and you must contact Epson for support.

[Power Cleaning Using the Product Control Panel](#)

[Power Cleaning Using a Computer Utility](#)

**Parent topic:** [Print Head Maintenance](#)

### Power Cleaning Using the Product Control Panel

You can run a Power Cleaning using the control panel on your product.

**Note:** After a Power Cleaning, you must turn off the product and wait at least 12 hours before running another Power Cleaning.

1. Turn off the product.
2. Visually check the ink levels and make sure each ink tank is at least one-third full.

**Caution:** If you run a Power Cleaning when the ink levels are low, you may damage the product.

3. Hold down the  power button, the **OK** button, and the down arrow button at the same time until the Power Cleaning screen appears.
4. Follow the on-screen instructions to run the Power Cleaning.
5. When Power Cleaning is finished, run a nozzle check.

**Parent topic:** [Power Cleaning](#)

## Related tasks



[Checking the Nozzles Using the Product Control Panel](#)

[Power Cleaning Using a Computer Utility](#)

### Power Cleaning Using a Computer Utility

You can run a Power Cleaning using a utility on your Windows or Mac computer.

**Note:** After running a Power Cleaning, you must turn off the product and wait at least 12 hours before running another Power Cleaning.

1. Make sure there are no errors on the LCD screen and the output tray is extended.
2. Load a few sheets of plain paper in the product.
3. Do one of the following:
  - **Windows:** Access the Windows Desktop and right-click the  icon for your product in the right side of the Windows taskbar, or click the up arrow and right-click . Select **Printer Settings** and click the **Maintenance** tab.
  - **Mac:** In the Apple menu or the Dock, select **System Preferences**. Select **Print & Fax**, **Print & Scan**, or **Printers & Scanners**, select your product, and select **Options & Supplies**. Select **Utility** and select **Open Printer Utility**.
4. Select **Power Cleaning**.

You see a window like this:

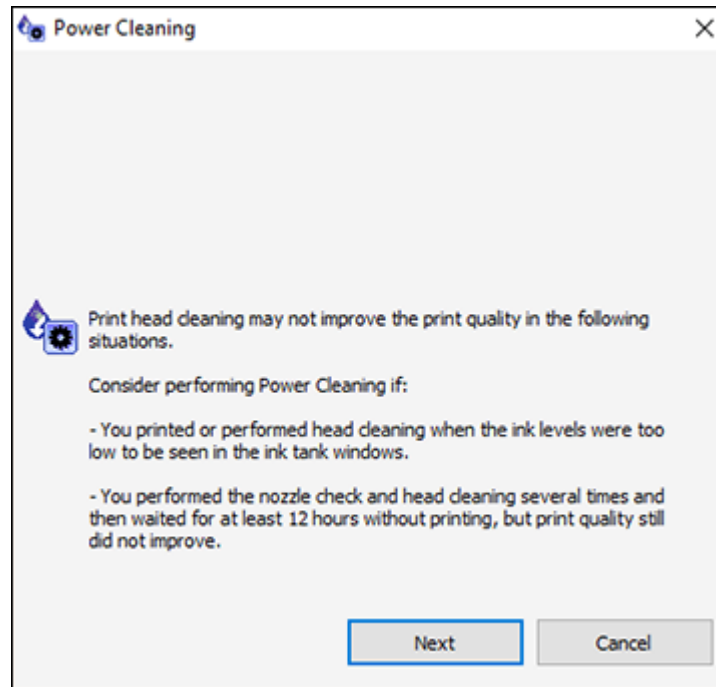

5. Follow the on-screen instructions to run a Power Cleaning.
6. When Power Cleaning is finished, run a nozzle check.

If the print quality did not improve, turn off the printer and wait at least 12 hours before running another Power Cleaning.

If the print quality does not improve after running the Power Cleaning utility multiple times, contact Epson for support.

**Parent topic:** [Power Cleaning](#)

**Related tasks**

[Checking the Nozzles Using a Computer Utility](#)

[Power Cleaning Using the Product Control Panel](#)

## Print Head Alignment

If your printouts become grainy or blurry, you notice misalignment of vertical lines, or you see dark or light horizontal bands, you may need to align the print head.

**Note:** Banding may also occur if your print head nozzles need cleaning.

[Aligning the Print Head Using the Product Control Panel](#)

**Parent topic:** [Adjusting Print Quality](#)

### Aligning the Print Head Using the Product Control Panel

You can align the print head using the control panel on your product.

1. Make sure there are no errors on the LCD screen, the CD/DVD tray is not inserted for printing, and the output tray is extended.
2. Load a few sheets of plain paper in the product.
3. Press the  home button, if necessary.
4. Press the arrow buttons to select **Settings** and press the **OK** button.
5. Select **Maintenance** and press the **OK** button.

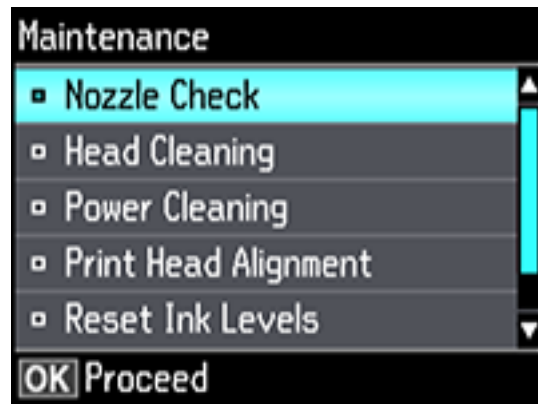

6. Select **Print Head Alignment** and press the **OK** button.

7. Do one of the following:
  - Select **Vertical Alignment** and press the **OK** button.
  - Select **Horizontal Alignment**, select **Color** or **B&W**, and press the **OK** button.

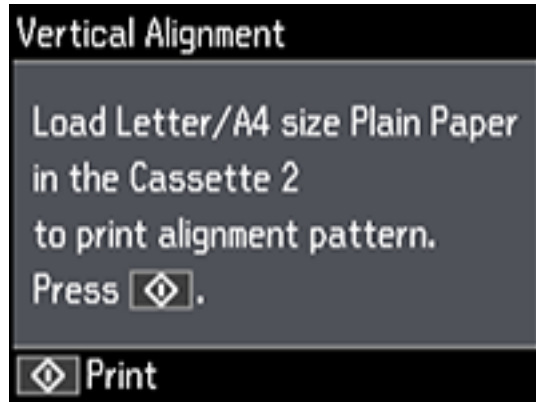

8. Press the [Start Button] to print an alignment sheet.

**Note:** Do not cancel printing while you are printing a head alignment pattern.

9. Check the printed pattern and select the number representing the most solid printed pattern for each set on the LCD screen.

**Vertical alignment**

#1

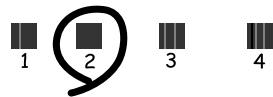

## Horizontal alignment



10. Press the **OK** button when you are finished.

**Parent topic:** [Print Head Alignment](#)

### Related topics

[Loading Paper](#)

## Cleaning the Paper Path

If you see ink on the back of a printout, you can clean the paper path to remove any excess ink.

1. Make sure the CD/DVD tray is not inserted for printing and the output tray is extended.
2. Load a few sheets of plain paper in the product.
3. Use the product control panel to make a copy, but without placing a document on the scanner glass.

**Note:** Make sure there is no dust or stains on the scanner glass or document cover.

4. Check the back of the ejected paper to see if it is clean.
5. Repeat as necessary until the paper comes out clean.

**Parent topic:** [Adjusting Print Quality](#)

### Related topics

[Copying](#)

[Loading Paper](#)

## Cleaning the Rear Paper Feed Path Using the Cleaning Sheet

If your paper does not feed correctly, clean the paper path inside the printer using the cleaning sheet that came with your product. The cleaning sheet should only be used to clean the rear paper feed.

**Caution:** Do not use tissues to clean inside the product; lint from tissues may clog the print head nozzles.

1. Make sure there is no paper in the rear paper feed slot and the output tray is extended.
2. Press the  home button, if necessary.
3. Press the arrow buttons to select **Maintenance** and press the **OK** button.
4. Press the down arrow button to select **Paper Guide Cleaning (Rear)** and press the **OK** button.
5. Follow the on-screen instructions to clean the paper path.
6. Remove the protective sheet from the cleaning sheet.
7. Load the cleaning sheet into the rear paper feed slot and slide the edge guides against the sheet. Make sure you insert the cleaning sheet with the cut corner at the lower right as shown.

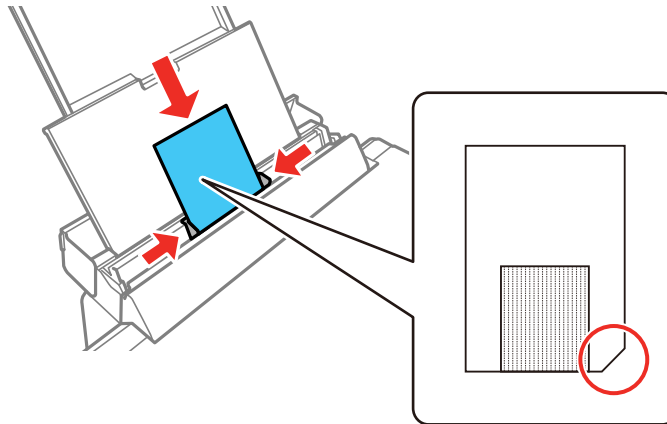

8. Press the  start button to feed the cleaning sheet through the product.
9. Check the cleaning sheet when it comes out of the product. You can repeat the previous steps up to three times as necessary (the cleaning sheet loses its effectiveness when used three times or more).

**Parent topic:** [Adjusting Print Quality](#)

## Cleaning the Printer Head Path

If the print quality has not improved after cleaning and aligning the print head and cleaning the paper path, the printer head path inside the printer may be smeared with ink.

To clean the printer head path, use the following:

- Several cotton swabs
- ¼ cup (59 ml) water containing 2 to 3 drops of mild dish detergent
- A small flashlight

**Caution:** Do not use any other liquid to clean the printer head path or you may damage your product.

1. Turn off the product.
2. Unplug the power cable.
3. Disconnect any connected cables.
4. Lift up the scanner unit.

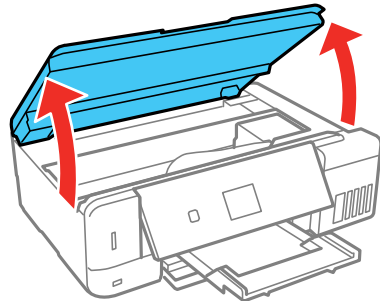

- Using the flashlight, check the translucent film shown here for ink smears.

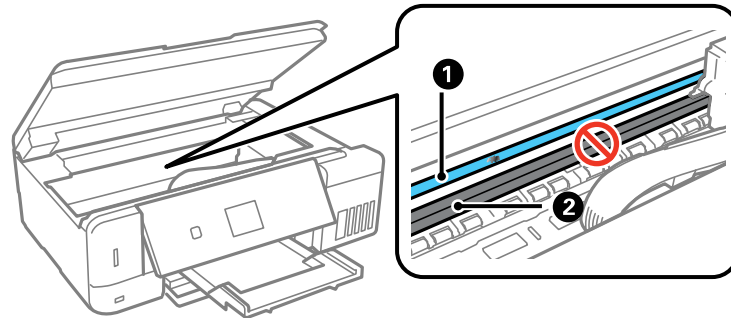

- 1 Translucent film
- 2 Print head rail

**Caution:** Do not touch the print head rail or wipe the grease off of it. You may not be able to print.

- Moisten a cotton swab with the water and detergent mixture and squeeze out any excess moisture, then lightly wipe the ink off the translucent film.

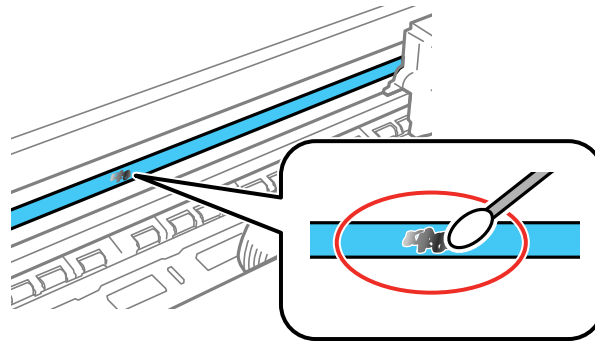

**Caution:** Do not press too hard on the film or you may dislocate the anchor springs and damage your product.

- Use a new, dry cotton swab to dry the translucent film.

8. Repeat steps 6 and 7 as necessary to clean all ink smears.
9. When the translucent film is dry, close the scanner unit.
10. Reconnect any disconnected cables, plug in the power cord, and turn on the product.

**Parent topic:** [Adjusting Print Quality](#)

## Checking the Number of Sheets

You can view an option that displays the number of sheets of paper that have fed through the product.



[Checking the Sheet Counter - Windows](#)

[Checking the Sheet Counter - Mac](#)

**Parent topic:** [Adjusting Print Quality](#)

## Checking the Sheet Counter - Windows

You can check the number of sheets of paper that have fed through the product by checking the sheet counter.

1. Access the Windows Desktop and right-click the  icon for your product in the right side of the Windows taskbar, or click the up arrow and right-click .
2. Select **Printer Settings**.
3. Click the **Maintenance** tab.
4. Select **Printer and Option Information**.

You see this window:

Printer and Option Information

Printer ID

ID

Option information has already been stored. Therefore, you do not need to enter any information.

Number of Sheets of Paper Fed into the Printer

The number of sheets is displayed when EPSON Status Monitor 3 is enabled.

Total Sheets

Borderless Sheets

5. After checking the number of sheets fed into the printer, click **OK** to close the window.

**Note:** The number of sheets is displayed only when Epson Status Monitor 3 is enabled.

**Parent topic:** [Checking the Number of Sheets](#)

## Checking the Sheet Counter - Mac

You can check the number of sheets of paper that have fed through the product by checking the sheet counter.

1. In the Apple menu or the Dock, select **System Preferences**. Select **Print & Fax**, **Print & Scan**, or **Printers & Scanners**, select your product, and select **Options & Supplies**. Select **Utility** and select **Open Printer Utility**.
2. Select **Printer and Option Information**.

You see this window:

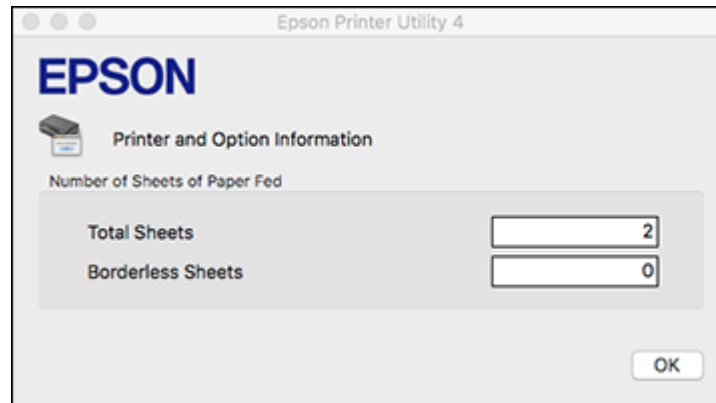

3. After checking the number of sheets fed into the printer, click **OK** to close the window.

**Parent topic:** [Checking the Number of Sheets](#)

---

# Cleaning and Transporting Your Product

See these sections if you need to clean or transport your product.

[Cleaning Your Product](#)

[Transporting Your Product](#)

## Cleaning Your Product

To keep your product working at its best, you should clean it several times a year.

Close the output tray, front cover, and rear paper feed cover when you are not using the product to protect it from dust.

**Caution:** Do not use a hard brush, alcohol, or paint thinner to clean the product or you may damage it. Do not use oil or other lubricants inside the product or let water get inside it.

1. Turn off the product.
2. Unplug the power cable.
3. Disconnect any connected cables.
4. Remove all the paper.
5. Clean the scanner glass with a soft, lint-free cloth (microfiber is recommended), moistened with a little glass cleaner.

**Caution:** Do not spray glass cleaner directly on the glass and do not press the glass surface with any force.

6. Clean the outer case and control panel with a soft, dry cloth. Do not use liquid or chemical cleansers.

**Parent topic:** [Cleaning and Transporting Your Product](#)

## Transporting Your Product

If you need to store your product or transport it some distance, prepare it for transportation as described here.

**Caution:** During transportation and storage, follow these guidelines:

- Avoid tilting the product, placing it vertically, or turning it upside down; otherwise ink may leak.

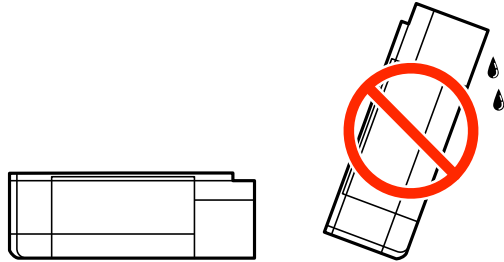

- When storing or transporting an opened ink bottle, do not tilt the bottle and do not subject it to impacts or temperature changes. Otherwise, ink may leak even if the cap on the ink bottle is tightened securely. Be sure to keep the ink bottle upright when tightening the cap, and take measures to prevent ink from leaking when transporting the ink bottles.
  - Do not put opened ink bottles in the box with the product.
  - Do not carry the product by its control panel; this may damage the product.
1. Turn off the product.
  2. Remove all the paper from the product.
  3. Unplug the power cable.
  4. Disconnect any connected cables.
  5. Lift up the scanner unit and check to see if the print head is in the far right position (the home position). If not, turn on the product, wait for the print head to move to the far right, then turn the product off again.

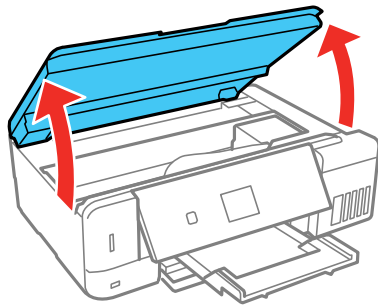

- Secure the print head to the case with tape.

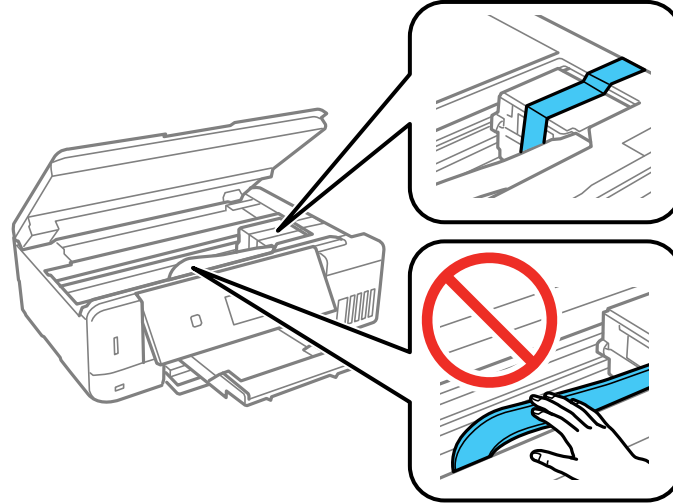

**Caution:** Do not place tape on the white flat cable inside the product; otherwise, you may damage your product.

- Open the ink tank cover. Make sure the ink tap caps are securely closed and close the ink tank cover.

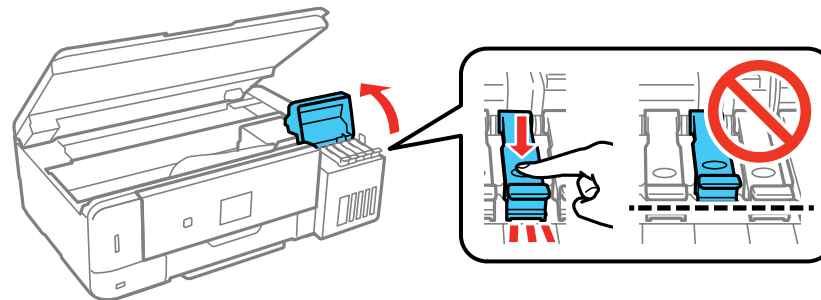

8. Lower the scanner unit.

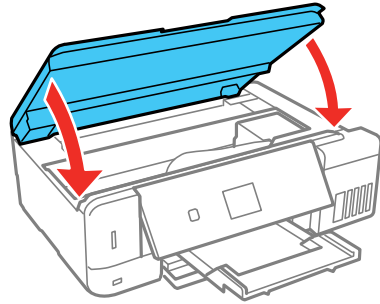

9. Close the rear paper feed support and rear paper feed cover. Close the output tray and the front cover, then lower the control panel.

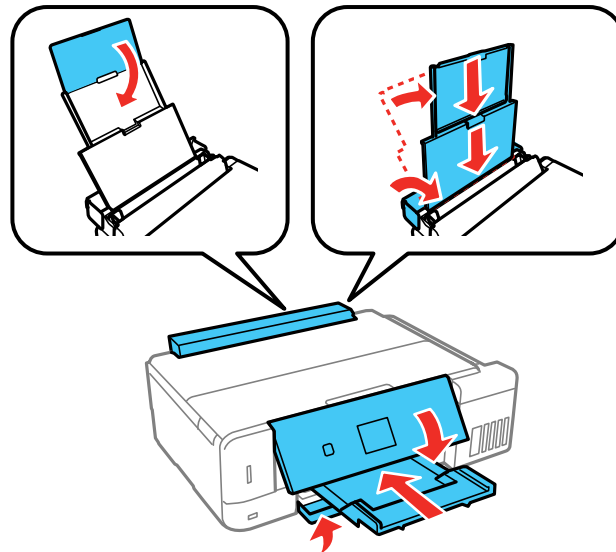

10. Place the product in its original packaging materials, if possible, or use equivalent cushioning around the product.

Be sure to remove the tape from the print head before turning on your product. If print quality has declined when you print again, clean and align the print head.

**Parent topic:** [Cleaning and Transporting Your Product](#)

**Related concepts**

[Print Head Cleaning](#)

[Print Head Alignment](#)

---

# Solving Problems

Check these sections for solutions to problems you may have using your product.

[Checking for Software Updates](#)

[Product Status Messages](#)

[Message Appears Prompting You to Reset Ink Levels](#)

[Running a Product Check](#)

[Resetting Control Panel Defaults](#)

[Solving Setup Problems](#)

[Solving Network Problems](#)

[Solving Copying Problems](#)

[Solving Paper Problems](#)

[Solving Problems Printing from a Computer](#)

[Solving Page Layout and Content Problems](#)

[Solving Print Quality Problems](#)

[Solving Scanning Problems](#)

[Solving Scanned Image Quality Problems](#)

[Solving Memory Card Problems](#)



[Solving CD/DVD Problems](#)

[Uninstall Your Product Software](#)

[Where to Get Help](#)

## Checking for Software Updates

Periodically, it's a good idea to check Epson's support website for free updates to your product software. Visit [epson.com/support](http://epson.com/support) (U.S.), [epson.ca/support](http://epson.ca/support) (Canada), or [epson.com.jm/support](http://epson.com.jm/support) (Caribbean) and select your product.

- **Windows:** Your printer software automatically checks for updates. You can also manually update the software by selecting **Software Update** here:
  - Accessing the Windows Desktop and right-clicking the  icon for your product in the right side of the Windows taskbar, or clicking the up arrow and right-clicking .
  - On the **Maintenance** tab in the printer settings window

You can also update the software by selecting **EPSON Software Updater** in the **EPSON** or **EPSON Software** program group, accessible by the **Start** button, or on the **Start** or **Apps** screens, depending on your version of Windows.

- **OS X:** You can manually update the software by opening the **Applications > Epson Software** folder and selecting **EPSON Software Updater**.
- **macOS 10.12.x:** You can manually update the software by opening the **App Store**, selecting **Updates**, searching for a software update option for Epson Software, and selecting **Update**.

**Parent topic:** [Solving Problems](#)

**Related tasks**

[Changing Automatic Update Options](#)

## Product Status Messages

You can often diagnose problems with your product by checking the messages on its LCD screen. You can also see help information and how-to instructions on the screen. Press the  home button, if necessary, select **Help** and press the **OK** button.

LCD screen message	Condition/solution
Operation canceled. An error occurred while saving.	A memory card or external storage device may be damaged. Make sure the memory card or external device is inserted correctly and meets the specifications for the product.
Printer error. Turn the power off and on again. For details, see documentation.	A fatal error has occurred. Turn the product off and then back on again. If the error continues, check for a paper jam. If there is no paper jam, contact Epson for support.
Communication error. Check if a computer is connected.	Make sure the computer is connected to your product and your software is installed correctly.
Paper Configuration is disabled. Some features may not be available. For details, see your documentation.	The Paper Configuration setting must be turned on to use AirPrint.

LCD screen message	Condition/solution
The printer's ink pad is nearing the end of its service life. Please contact Epson support.	The ink pad is near the end of its service life and the message will be displayed until the ink pad is replaced. Contact Epson for support. (To resume printing, press the  start button.)
The printer's ink pad is at the end of its service life. Please contact Epson support.	The ink pad is at the end of its service life. Turn off the product and contact Epson for support.
Update the root certificate to use cloud services.	Access your product's built-in Web Config utility and update the root certificate for your product.
Combination of IP address and subnet mask is invalid. See your documentation.	There is a problem with the network connection to your product. Check the solutions in this guide.
Recovery mode	An error has occurred during firmware updating. Connect your product using a USB cable and try updating the firmware again. If you still receive this error message, contact Epson for support.

**Note:** The ink pads in the printer collect, distribute, and contain the ink that is not used on printed pages. During the life of your product it may reach a condition where either satisfactory print quality cannot be maintained or the ink pads have reached the end of their usable life. The Epson Status Monitor, your LCD screen, or lights on the control panel will advise you when these parts need replacing. If this happens during the standard warranty of the product, the exchange of the product or replacement of the pads is covered under the standard warranty. If the product is out of warranty, the pads can be replaced by any Epson authorized service provider. The waste ink pads are not a user-replaceable part.

**Parent topic:** [Solving Problems](#)

**Related references**

[Memory Card File Specifications](#)

[Paper Jam Problems Inside the Product](#)

[Paper Jam Problems in the Paper Cassette](#)

[Paper Jam Problems in the Rear Cover](#)

[Where to Get Help](#)

**Related tasks**[Inserting a Memory Card](#)[Using AirPrint](#)[Selecting the Paper Settings for Each Source - Control Panel](#)**Related topics**[Wi-Fi or Wired Networking](#)

## Message Appears Prompting You to Reset Ink Levels

If you see a message on the LCD screen prompting you to reset the ink levels, do the following:

1. Refill all of the ink tanks or the ink tanks indicated on the LCD screen all the way to the top.

**Note:** Depending on the operating conditions, you may see the ink reset message even when there is still ink in the tanks.

2. Select the colors that you refilled on the LCD screen.
3. Follow the instructions on the LCD screen to reset the ink levels.

**Note:** The product has a low ink alert system. The accuracy of this system depends on the user refilling the ink tanks correctly. The product cannot directly measure the ink levels in the tanks; instead it estimates the amount of ink remaining by internally monitoring ink usage. The low ink alert system may generate inaccurate messages if the ink tanks are not refilled according to these instructions.

As a precaution, perform regular visual inspections of the ink tanks to ensure ink levels do not fall below the lower line. Continued use of the product when the ink level is below the lower line on the tank could damage the product.

**Parent topic:** [Solving Problems](#)

**Related topics**[Refilling Ink](#)

## Running a Product Check

Running a product check helps you determine if your product is operating properly.

1. Disconnect any interface cables connected to your product.
2. Load plain paper in the product.
3. Press the  home button, if necessary.

4. Press the arrow buttons to select **Settings** and press the **OK** button.
5. Select **Maintenance** and press the **OK** button.

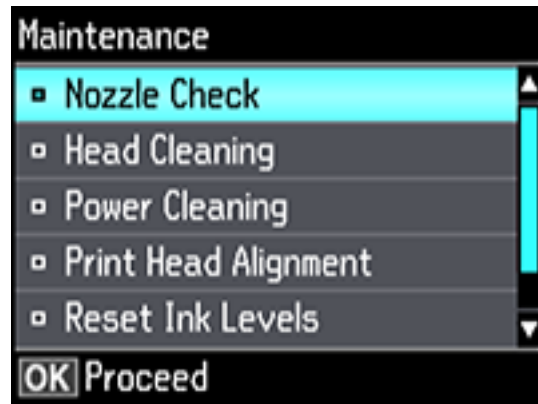

6. Select **Nozzle Check** and press the **OK** button.

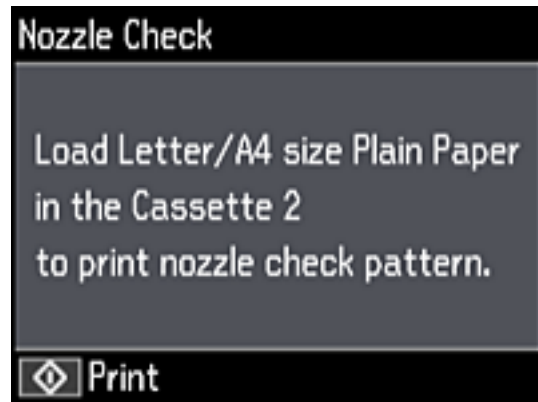

7. Press the  start button.  
The nozzle check pattern is printed.
8. Do one of the following, depending on the results of the product check:
  - If the page prints and the nozzle check pattern is complete, the product is operating properly. Any operation problem you may have could be caused by your computer, cable, software, or selected

settings. Check the other solutions in this book or try uninstalling and reinstalling your printer software.

- If the page prints but the nozzle check pattern has gaps, clean or align the print head.
- If the page does not print, the product may have a problem. Check the other solutions in this manual. If they do not work, contact Epson.

Parent topic: [Solving Problems](#)

## Resetting Control Panel Defaults

If you have a problem with settings on the product control panel, you can reset them to their factory defaults. You can choose which settings to reset or reset them all.

1. Press the  home button, if necessary.
2. Press the arrow buttons to select **Settings** and press the **OK** button.
3. Select **Restore Default Settings** and press the **OK** button.

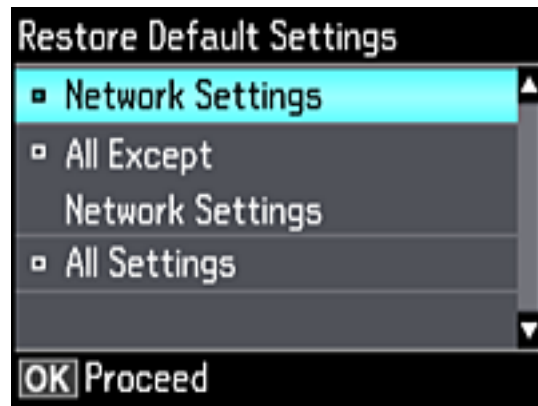

4. Select one of these options:
  - **Network Settings**: Resets all network settings.
  - **All Except Network Settings**: Resets all control panel settings, except for network settings.
  - **All Settings**: Resets all control panel settings.You see a confirmation screen.
5. Select **Yes** to reset the selected settings. (Select **No** if you want to cancel the operation.)

Parent topic: [Solving Problems](#)

## Solving Setup Problems

Check these sections if you have problems while setting up your product.

[Noise After Filling the Ink](#)

[Software Installation Problems](#)

[Control Panel Setup Problems](#)

Parent topic: [Solving Problems](#)

### Noise After Filling the Ink

If you hear noises from your product after filling the ink tanks with ink, check these explanations:

- The first time you fill the tanks with ink, the product must charge its print head. Wait until charging finishes before you turn off the product, or it may charge improperly and use excess ink the next time you turn it on. Your product is finished charging the print head when the  power light stops flashing.
- If the product's print head stops moving or making noise, and the charging process has not finished after approximately 20 minutes, turn off your product. Turn it back on and check to see if charging is still in progress. If it is still in progress, contact Epson for help.

Parent topic: [Solving Setup Problems](#)

### Software Installation Problems

If you have problems while installing your product software, try these solutions:

- Make sure your product is turned on and any necessary cables are securely connected at both ends. If you still have problems installing software, disconnect the cable and carefully follow the instructions on the *Start Here* sheet. Also make sure your system meets the requirements for your operating system.
- Close any other programs, including screen savers and virus protection software, and install your product software again.
- In Windows, make sure your product is selected as the default printer and the correct port is shown in the printer properties.
- If you see any error message or your software does not install correctly in Windows, you may not have software installation privileges. Contact your system administrator.

Parent topic: [Solving Setup Problems](#)

## Control Panel Setup Problems

If you have problems setting up the control panel, try these solutions:

- To view LCD screen text in a different language, select a different language setting for the panel.
- To adjust the position of the control panel, carefully raise or lower it.

**Parent topic:** [Solving Setup Problems](#)

**Related topics**

[Using the Control Panel](#)

## Solving Network Problems

Check these solutions if you have problems setting up or using your product on a network.

**Note:** Breakdown or repair of this product may cause loss of network data and settings. Epson is not responsible for backing up or recovering data and settings during or after the warranty period. We recommend that you make your own backup or print out your network data and settings.

[Product Cannot Connect to a Wireless Router or Access Point](#)

[Network Software Cannot Find Product on a Network](#)

[Product Does Not Appear in Mac Printer Window](#)

[Cannot Print Over a Network](#)

[Cannot Scan Over a Network](#)

**Parent topic:** [Solving Problems](#)

## Product Cannot Connect to a Wireless Router or Access Point

If your product has trouble finding or connecting to a wireless router or access point, try these solutions:

- If you are connecting the product via Wi-Fi Protected Setup (WPS) and the Wi-Fi icon on your product's LCD screen is not lit or does not appear, make sure you select one of the WPS options from the product control panel within 2 minutes of pressing the WPS button on your router.
- Make sure to place your product within contact range of your 2.4 GHz router or access point. Avoid placing your product near a microwave oven, 2.4 GHz cordless phone, or large metal object, such as a filing cabinet.

**Note:** If you are using a 5 GHz wireless router, set the router to operate in dual band (2.4 GHz and 5 GHz) mode. If your router uses a single network name (SSID) for both the 2.4 GHz and 5 GHz band, give each band its own network name (SSID) instead, such as Home Network 2.4 GHz and Home

Network 5 GHz. See your router documentation or contact your internet service provider for instructions.

- Verify that your router or access point is operating correctly by connecting to it from your computer or another device.
- You may need to disable the firewall and any anti-virus software on your wireless router or access point.
- Check to see if access restrictions, such as MAC address filtering, are set on the router or access point. If access restrictions are set, add your product's MAC address to your router's address list. To obtain your product's MAC address, print a network status sheet. Then follow the instructions in your router or access point documentation to add the address to the list.
- If your router or access point does not broadcast its network name (SSID), follow the instructions that came with your product to enter your wireless network name manually.
- If your router or access point has security enabled, determine the kind of security it is using and any required password or passphrase for connection. Then make sure to enter the exact WEP key or WPA passphrase correctly.
- Check if your computer is restricting the available wireless channels. If so, verify that your wireless access point is using one of the usable channels and change to a usable channel, if necessary.
- If you are using a Wi-Fi Direct connection that suddenly disconnects, the Wi-Fi direct password on your device may have been changed. If necessary, delete the existing **DIRECT-xxxxxxx** connection settings from your device and enter a new password. See your device documentation for instructions.

**Parent topic:** [Solving Network Problems](#)

**Related topics**

[Wi-Fi or Wired Networking](#)

## Network Software Cannot Find Product on a Network

If EpsonNet Setup cannot find your product on a network, try these solutions:

- Make sure your product is turned on and connected to your network. Verify connection using your product control panel.
- Check if your network name (SSID) contains non-ASCII characters. Your product cannot display non-ASCII characters.
- Make sure your product is not connected to a guest network.
- If necessary, reinstall your product software and try running EpsonNet Setup again:
  1. Reset your product's network settings to their factory defaults.

2. **Windows only:** uninstall your product software.
3. Initialize your router following the instructions in your router documentation.

**Note:** If you are reading these instructions online, you will lose your Internet connection when you initialize your router, so note the next step before initializing it.

4. Download your product software from the Epson website using the instructions on the *Start Here* sheet.
- If you have replaced your router, reinstall your product software to connect to the new router.

**Note:** If you are using a 5 GHz wireless router, set the router to operate in dual band (2.4 GHz and 5 GHz) mode. If your router uses a single network name (SSID) for both the 2.4 GHz and 5 GHz band, give each band its own network name (SSID) instead, such as Home Network 2.4 GHz and Home Network 5 GHz. See your router documentation or contact your internet service provider for instructions.

- Check to see if your wireless router or access point has an enabled Privacy Separator function that is preventing detection of your device over the network. See your router or access point documentation for instructions on disabling the Privacy Separator function.

**Parent topic:** [Solving Network Problems](#)

**Related concepts**

[Uninstall Your Product Software](#)

**Related topics**

[Wi-Fi or Wired Networking](#)

## Product Does Not Appear in Mac Printer Window

If your product does not appear in the Mac printer window, try these solutions:

- Turn your product off, wait 30 seconds, then turn it back on again.
- If you are connecting the product via Wi-Fi Protected Setup (WPS) and the Wi-Fi icon on your product's LCD screen is not lit, make sure you select one of the WPS options from the product control panel within 2 minutes of pressing the WPS button on your router.
- If you are connecting the product wirelessly via EpsonNet Setup and the Wi-Fi icon does not appear lit on your LCD screen, make sure your product software was installed correctly. If necessary, reinstall your software.

**Note:** If you are using a 5 GHz wireless router, set the router to operate in dual band (2.4 GHz and 5 GHz) mode. If your router uses a single network name (SSID) for both the 2.4 GHz and 5 GHz band, give each band its own network name (SSID) instead, such as Home Network 2.4 GHz and Home Network 5 GHz. See your router documentation or contact your internet service provider for instructions.

**Parent topic:** [Solving Network Problems](#)

**Related concepts**

[Uninstall Your Product Software](#)

**Related topics**

[Wi-Fi or Wired Networking](#)

## Cannot Print Over a Network

If you cannot print over a network, try these solutions:

- Make sure that your product is turned on.
- Make sure you install your product's network software as described in your product documentation.
- Print a network status sheet and verify that the network settings are correct. If the network status is **Disconnected**, check any cable connections and turn your product off and then on again.
- If you are using TCP/IP, make sure the product's IP address is set correctly for your network. If your network does not assign IP addresses using DHCP, set the IP address manually.
- Make sure your computer and product are both using the same wireless network.
- If network printing is slow, print a network status sheet and check the signal strength. If it is poor, place your product closer to your router or access point. Avoid placing your product near a microwave oven, 2.4 GHz cordless phone, or large metal object, such as a filing cabinet.

**Note:** If you are using a 5 GHz wireless router, set the router to operate in dual band (2.4 GHz and 5 GHz) mode. If your router uses a single network name (SSID) for both the 2.4 GHz and 5 GHz band, give each band its own network name (SSID) instead, such as Home Network 2.4 GHz and Home Network 5 GHz. See your router documentation or contact your internet service provider for instructions.

- Check to see if your wireless router or access point has an enabled Privacy Separator function that is preventing printing from a device over the network. See your router or access point documentation for instructions on disabling the Privacy Separator function.

- If you are connecting the product wirelessly via EpsonNet Setup and the Wi-Fi connection icon is not lit or does not appear on the product's LCD screen, make sure your product software was installed correctly. If necessary, reinstall your software.

**Parent topic:** [Solving Network Problems](#)

**Related concepts**

[Uninstall Your Product Software](#)

**Related tasks**

[Printing a Network Status Sheet](#)

**Related topics**

[Wi-Fi or Wired Networking](#)

## Cannot Scan Over a Network

If you cannot start Epson Scan 2 for scanning over a network, try these solutions:

- If you cannot scan from your product control panel, make sure you restarted your computer after installing the product software. Make sure the Event Manager program is not being blocked by your firewall or security software.

**Note:** If you are using a 5 GHz wireless router, set the router to operate in dual band (2.4 GHz and 5 GHz) mode. If your router uses a single network name (SSID) for both the 2.4 GHz and 5 GHz band, give each band its own network name (SSID) instead, such as Home Network 2.4 GHz and Home Network 5 GHz. See your router documentation or contact your internet service provider for instructions.

- If you are scanning a large original at a high resolution, a network communication error may occur. Try scanning again at a lower resolution.
- If network communication was interrupted while starting Epson Scan 2, exit Epson Scan 2, wait a few seconds, and restart it. If Epson Scan 2 cannot restart, turn off your product, turn it back on, and try restarting Epson Scan 2 again.
- Check the scanner setting and reset the connection if necessary using Epson Scan 2 Utility:

**Windows 10:** Click  and select **EPSON > Epson Scan 2 Utility**. Make sure your product is selected. If necessary, select the **Other** tab and click **Reset**.

**Windows 8.x:** Navigate to the **Apps** screen, select **EPSON**, and select **Epson Scan 2 Utility**. Make sure your product is selected. If necessary, select the **Other** tab and click **Reset**.

**Windows (other versions):** Click  or **Start > All Programs** or **Programs > EPSON > Epson Scan 2 > Epson Scan 2 Utility**. Make sure your product is selected. If necessary, select the **Other** tab and click **Reset**.

**Mac:** Open the **Applications** folder, click **Epson Software**, and click **Epson Scan 2 Utility**. Make sure your product is selected. If necessary, select the **Other** tab and click **Reset**.

- You may need to disable the firewall and any anti-virus software on your wireless router or access point.

**Parent topic:** [Solving Network Problems](#)

#### **Related topics**

[Wi-Fi or Wired Networking](#)

[Scanning](#)

## **Solving Copying Problems**

Check these solutions if you have problems copying with your product.

[Product Makes Noise, But Nothing Copies](#)

[Product Makes Noise When It Sits for a While](#)

**Parent topic:** [Solving Problems](#)

## **Product Makes Noise, But Nothing Copies**

If your product makes a noise, but nothing copies, try these solutions:

- Run a nozzle check to see if any of the print head nozzles are clogged. Then clean the print head, if necessary.
- If the nozzle check page does not print, but the product's power is on, make sure your product software is installed correctly.
- Make sure your product is level (not tilted).

**Parent topic:** [Solving Copying Problems](#)

#### **Related concepts**

[Print Head Nozzle Check](#)

[Print Head Cleaning](#)

## **Product Makes Noise When It Sits for a While**

Your product is performing routine maintenance. This is normal.

**Parent topic:** [Solving Copying Problems](#)

## Solving Paper Problems

Check these sections if you have problems using paper with your product.

[Paper Feeding Problems](#)

[Paper Jam Problems Inside the Product](#)

[Paper Jam Problems in the Paper Cassette](#)

[Paper Jam Problems in the Rear Cover](#)

[Paper Ejection Problems](#)

**Parent topic:** [Solving Problems](#)

## Paper Feeding Problems

If you have problems feeding paper, try these solutions:

- Make sure the paper cassette is inserted all the way in the printer.
- If paper does not feed correctly, remove and reload it in the cassette and adjust the edge guides. Make sure the paper stack is not above the tab on the edge guides inside the cassette.
- If multiple pages feed at once, remove the paper, fan the edges to separate the sheets, and reload it.
- Do not load more than the recommended number of sheets.
- Make sure your paper meets the specifications for your product.
- If paper jams when you print on both sides of the paper, try loading fewer sheets.
- For best results, follow these guidelines:
  - Use new, smooth, high-quality paper that is not curled, creased, old, too thin, or too thick.
  - Load paper in the cassette printable side down.
  - Follow any special loading instructions that came with the paper.

**Parent topic:** [Solving Paper Problems](#)

### Related references

[Paper Loading Capacity](#)

[Paper Specifications](#)

[Paper Jam Problems Inside the Product](#)

[Paper Jam Problems in the Paper Cassette](#)

[Paper Jam Problems in the Rear Cover](#)

## Paper Jam Problems Inside the Product

If you see a message that paper has jammed inside the product, follow the steps here or on the LCD screen to clear the jam.

1. Cancel the print job, if necessary.
2. Lift up the scanner unit.

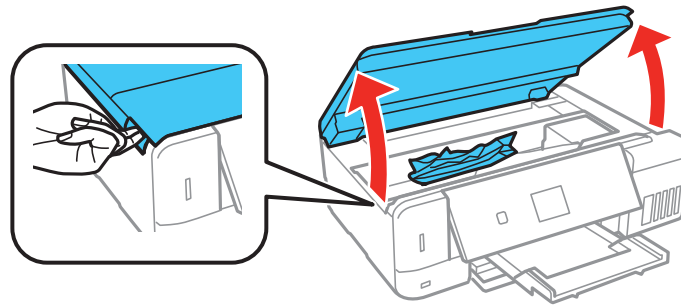

3. Remove any jammed paper inside.

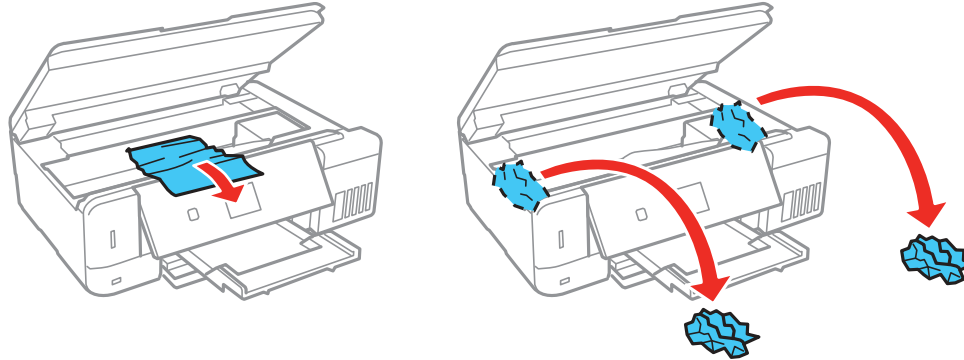

**Caution:** Do not touch the flat white cable, translucent film, or ink tubes inside the printer.

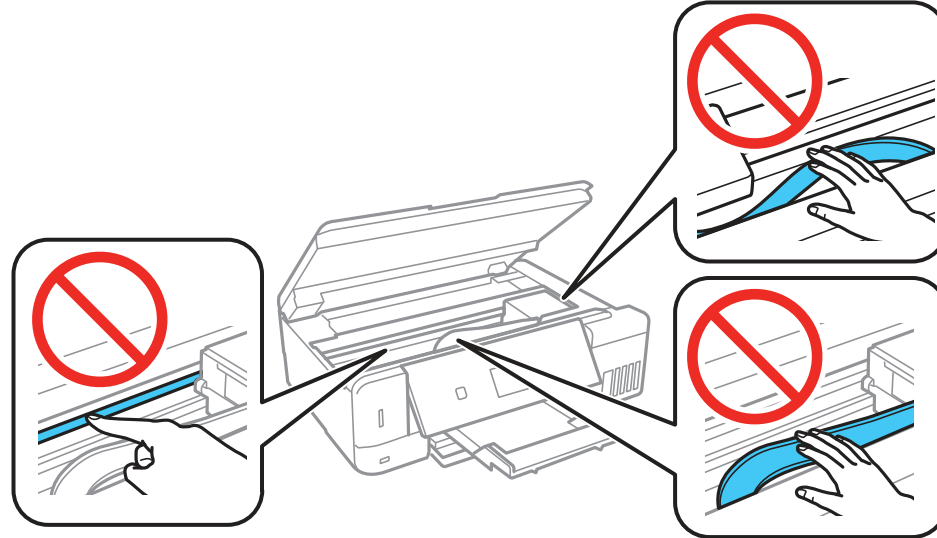

4. Close the scanner unit.

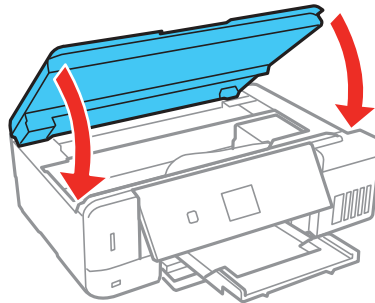

5. Follow the prompts on the LCD screen to clear any error messages. If you still see a paper jam message, check the other paper jam solutions.

**Parent topic:** [Solving Paper Problems](#)

**Related references**

[Paper Jam Problems in the Paper Cassette](#)

## Paper Jam Problems in the Rear Cover

### Related tasks

[Cancelling Printing Using a Product Button](#)

## Paper Jam Problems in the Paper Cassette

If you see a message that paper has jammed in the paper cassette, follow the steps here or on the LCD screen to clear the jam.

1. Cancel the print job, if necessary.
2. Close the output tray.

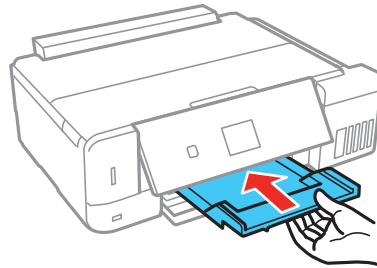

3. Pull out and remove both paper cassettes.

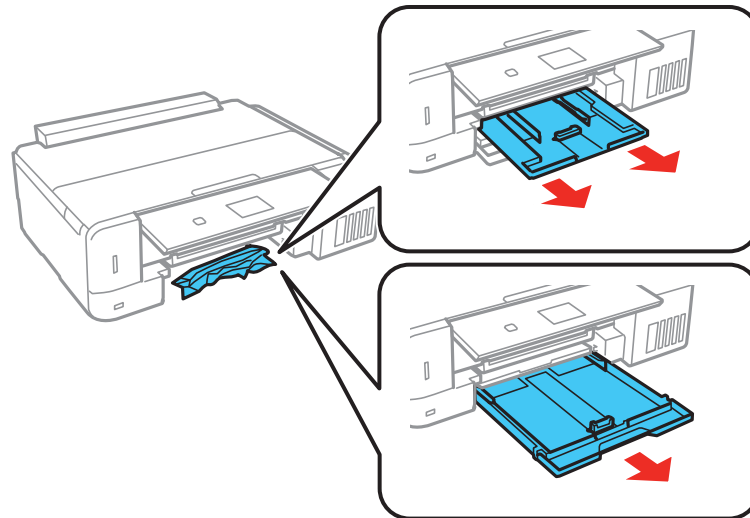

4. Remove the jammed paper.

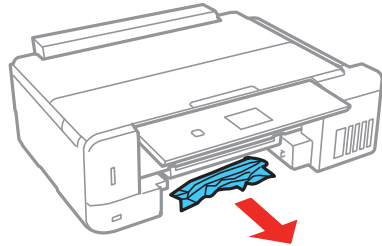

5. Make sure the paper you load is under the edge guides.
6. Keep the cassette flat as you insert it. Insert Cassette 1 (upper cassette) it until the arrows on the right side line up.
7. Follow the prompts on the LCD screen to clear any error messages. If you still see a paper jam message, check the other paper jam solutions.

**Parent topic:** [Solving Paper Problems](#)

**Related references**

[Paper Jam Problems Inside the Product](#)

[Paper Jam Problems in the Rear Cover](#)

**Related tasks**

[Cancelling Printing Using a Product Button](#)

## Paper Jam Problems in the Rear Cover

If you see a message that paper has jammed in the rear cover, follow the steps here or on the LCD screen to clear the jam.

1. Cancel the print job, if necessary.

2. Press the buttons to release the rear cover and remove it from your product.

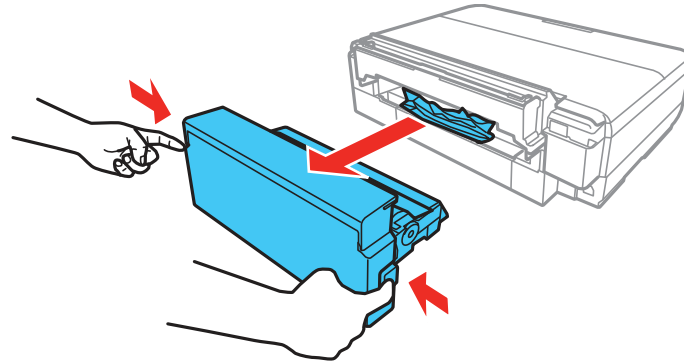

3. Remove any jammed paper from inside the product.

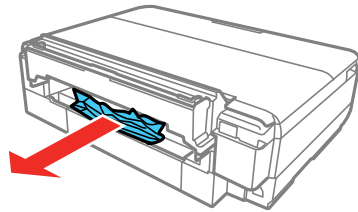

4. Reattach the rear cover.

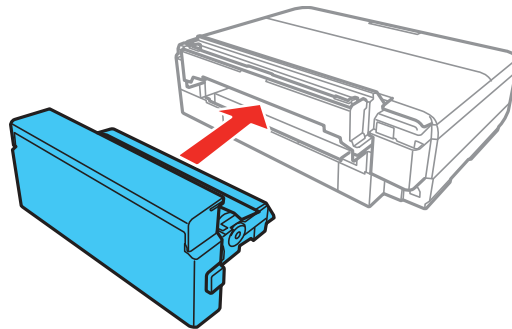

5. Follow the prompts on the LCD screen to clear any error messages. If you still see a paper jam message, check the other paper jam solutions.

**Parent topic:** [Solving Paper Problems](#)

**Related references**

[Paper Jam Problems Inside the Product](#)

[Paper Jam Problems in the Paper Cassette](#)

**Related tasks**

[Cancelling Printing Using a Product Button](#)

## Paper Ejection Problems

If you have problems with paper ejecting properly, try these solutions:

- If paper does not eject fully, you may have set the wrong paper size. Cancel printing to eject the paper. Select the correct paper size when you reprint.
- If paper is wrinkled when it ejects, it may be damp or too thin. Load new paper and be sure to select the correct paper type setting when you reprint.

**Parent topic:** [Solving Paper Problems](#)

**Related references**

[Paper Specifications](#)

[Paper or Media Type Settings - Printer Software](#)

**Related tasks**

[Cancelling Printing Using a Product Button](#)

**Related topics**

[Loading Paper](#)

## Solving Problems Printing from a Computer

Check these sections if you have problems while printing from your computer.

**Note:** When printing using AirPrint, the available print settings are different from those covered in this manual. See the Apple website for details.

[Nothing Prints](#)

[Product Icon Does Not Appear in Windows Taskbar](#)

[Printing is Slow](#)

Parent topic: [Solving Problems](#)

## Nothing Prints

If you have sent a print job and nothing prints, try these solutions:





- Make sure your product is turned on.
- Make sure any interface cables are connected securely at both ends.
- If you connected your product to a USB hub, make sure it is a first-tier hub. If it still does not print, connect your product directly to your computer instead of the hub.
- Run a product check to see if a test page prints. If the test page prints, check to see if your product software is installed correctly.
- In Windows, make sure your product is selected as the default printer.
- In Windows, delete all jobs from the Windows Spooler. Click **Print Queue** on the Maintenance tab in the printer settings window, and cancel any stalled print jobs.

Parent topic: [Solving Problems Printing from a Computer](#)

## Product Icon Does Not Appear in Windows Taskbar

If you do not see your product icon in the Windows taskbar, first try restarting your computer. If that does not work, try this solution:

1. Do one of the following:

- **Windows 10:** Click  and select  (Settings) > **Devices > Printers & scanners**. Select your product name and select **Manage > Printing preferences**.
- **Windows 8.x:** Navigate to the **Apps** screen and select **Control Panel > Hardware and Sound > Devices and Printers**. Right-click your product name, select **Printing Preferences**, and select your product name again if necessary.
- **Windows 7:** Click  and select **Devices and Printers**. Right-click your product name, select **Printing Preferences**, and select your product name again if necessary.
- **Windows Vista:** Click , select **Control Panel**, and click **Printer** under **Hardware and Sound**. Right-click your product name, select **Printing Preferences**, and select your product name again if necessary.

2. Click the **Maintenance** tab.

3. Click the **Extended Settings** button.

4. Select **Enable EPSON Status Monitor 3** and click **OK**.
5. Click the **Monitoring Preferences** button.
6. Click the checkbox for the option that adds the shortcut icon to the taskbar.
7. Click **OK** to close the open program windows.

**Parent topic:** [Solving Problems Printing from a Computer](#)

## Printing is Slow

If printing becomes slow, try these solutions:

- Make sure your system meets the requirements for your operating system. If you are printing a high-resolution image, you may need more than the minimum requirements. If necessary, increase your system's memory.
- If you are using Windows 7, close the **Devices and Printers** window before you print.
- On a Mac, make sure you download and install the Epson printer driver.
- Make sure **Quiet Mode** is turned off.
- Clear space on your hard drive or run a defragmentation utility to free up existing space.
- Close any programs you are not using when you print.
- If your product is connected to a USB hub, connect it directly to your computer instead.
- If printing becomes slower after printing continuously for a long time, the product may have automatically slowed down to protect the print mechanism from overheating or becoming damaged. Let the product rest with the power on for 30 minutes, then try printing again.

For the fastest printing, select the following settings in your product software:

- Make sure the paper type setting matches the type of paper you loaded.
- Turn on any high speed settings in your product software.
- Select a lower print quality setting.
- Make sure the ink drying time has not been increased for double-sided printing.
- **Windows:** Click the **Maintenance** or **Utility** tab, select **Extended Settings** or **Speed and Progress**, and select the following settings:
  - **Always Spool RAW Datatype**
  - **Page Rendering Mode**
  - **Print as Bitmap**

- **Windows:** Select **Printer Properties**, click the **More Options** tab and make sure the **High Speed** setting is enabled.
- **Mac:** Select **System Preferences**, select **Printers & Scanners**, then select your product. Select **Options & Supplies**, then select **Options** (or **Driver**) and enable the **High Speed Printing** setting.

If printing is still slow and you are using Windows 7 or Windows Vista, try the following:

1. Click  and select **Computer** or **My Computer**. Double-click the **C:** drive and open these folders: **ProgramData > EPSON > PRINTER**.

**Note:** If you do not see the ProgramData folder, open the **Organize** menu and select **Folder and search options**. In the window that appears, click the **View** tab, select **Show hidden files, folders, and drives** in the Advanced settings list, and click **OK**.

2. Right-click the **EPAUDF01.AUD** file and select **Delete**.
3. Restart your computer and try printing again.

**Parent topic:** [Solving Problems Printing from a Computer](#)

#### **Related references**

[Windows System Requirements](#)

[Mac System Requirements](#)

[Paper or Media Type Settings - Printer Software](#)

#### **Related tasks**

[Selecting Basic Print Settings - Windows](#)

[Selecting Extended Settings - Windows](#)

[Selecting Basic Print Settings - Mac](#)

[Selecting Printing Preferences - Mac](#)

## **Solving Page Layout and Content Problems**

Check these sections if you have problems with the layout or content of your printed pages.

**Note:** When printing using AirPrint, the available print settings are different from those covered in this manual. See the Apple website for details.

[Inverted Image](#)

[Too Many Copies Print](#)

[Blank Pages Print](#)

[Incorrect Margins on Printout](#)  
[Border Appears on Borderless Prints](#)  
[Incorrect Characters Print](#)  
[Incorrect Image Size or Position](#)  
[Slanted Printout](#)

**Parent topic:** [Solving Problems](#)

## Inverted Image

If your printed image is inverted unexpectedly, try these solutions:

- Turn off any mirror or inversion settings in your printing application.
- Turn off the **Mirror Image**, **Flip horizontally**, or **Reverse page orientation** settings in your printer software. (This option has different names, depending on your operating system version.)

**Note:** Leave these options turned on when you print on Epson Iron-on Cool Peel Transfer paper, if available for your product.

**Parent topic:** [Solving Page Layout and Content Problems](#)

### Related tasks

[Selecting Basic Print Settings - Mac](#)  
[Selecting Additional Layout and Print Options - Windows](#)

## Too Many Copies Print

Make sure that the **Copies** setting in your printing program or printer software is not set for multiple copies.

**Parent topic:** [Solving Page Layout and Content Problems](#)

## Blank Pages Print

If blank pages print unexpectedly, try these solutions:

- Make sure you selected the correct paper size settings in your printing program and printer software.
- If a blank page exists in a document you are printing and you want to skip printing it, select the **Skip Blank Page** setting in your printer software, if available.
- Run a print head nozzle check to see if any of the nozzles are clogged. Then clean the print head, if necessary.

- Make sure your product is selected as the printer in your printing program.
- You may need to refill the ink. Visually check the ink levels.

**Parent topic:** [Solving Page Layout and Content Problems](#)

**Related concepts**

[Print Head Cleaning](#)

[Print Head Nozzle Check](#)

**Related tasks**

[Selecting Basic Print Settings - Windows](#)

[Selecting Extended Settings - Windows](#)

[Selecting Basic Print Settings - Mac](#)

## Incorrect Margins on Printout

If your printed page has incorrect margins, try these solutions:

- Make sure you selected the correct paper size settings in your printing program and printer software.
- Make sure you selected the correct margins for your paper size in your printing program.
- Make sure your paper is positioned correctly for feeding into the printer.

You can use the preview option in your printer software to check your margins before you print.

**Parent topic:** [Solving Page Layout and Content Problems](#)

**Related tasks**

[Selecting Basic Print Settings - Windows](#)

[Selecting Basic Print Settings - Mac](#)

[Selecting Page Setup Settings - Mac](#)

## Border Appears on Borderless Prints

If you see a border on borderless prints, try these solutions:

- Make sure you are printing on a compatible borderless paper type and size.

**Note:** For custom paper sizes, make sure you select a supported borderless page width.

- **Windows:** Make sure you selected the **Borderless** setting in your printer software.
- **Mac:** Make sure you selected the **Borderless** checkbox or a paper size with a **Borderless** option in your printer software.

- Adjust the **Expansion** setting to adjust the amount of image expansion on the edges of borderless prints.
- Make sure the image size and the paper size are set correctly; if the image is small, the enlargement may not be enough to cover the paper.

**Parent topic:** [Solving Page Layout and Content Problems](#)

#### **Related references**

[Borderless Paper Type Compatibility](#)

#### **Related tasks**

[Selecting Basic Print Settings - Windows](#)

[Selecting Basic Print Settings - Mac](#)

[Selecting Page Setup Settings - Mac](#)

## **Incorrect Characters Print**

If incorrect characters appear in your prints, try these solutions before reprinting:

- Make sure any cables are securely connected at both ends.
- In Windows, delete all jobs from the Windows Spooler. Click **Print Queue** on the Maintenance tab in the printer settings window, and cancel any stalled print jobs.
- If your product is connected to a USB hub, connect it directly to your computer instead.
- If incorrect characters still appear in your prints, try connecting your product using a different cable.

**Parent topic:** [Solving Page Layout and Content Problems](#)

## **Incorrect Image Size or Position**

If your printed image is the wrong size or in the wrong position, try these solutions:

- Make sure you selected the correct paper size and layout settings in your printing program and printer software.
- Make sure you selected the correct paper size on the control panel.
- Make sure your paper is positioned correctly for feeding into the printer.
- Clean the scanner glass and document cover.
- If the edges of a copy are cropped, slightly move the original away from the edges of the scanner glass.
- Make sure you selected the correct margins for your paper size in your printing program.

You can use the preview option in your printer software to check your margins before you print.

**Parent topic:** [Solving Page Layout and Content Problems](#)

**Related tasks**

[Selecting Basic Print Settings - Windows](#)

[Selecting Basic Print Settings - Mac](#)

[Selecting Page Setup Settings - Mac](#)

**Related topics**

[Loading Paper](#)

## Slanted Printout

If your printouts are slanted, try these solutions:

- Slide the edge guides against the edges of the paper.
- Select a higher print quality setting in your printer software.
- Turn off any high speed settings in your product software.
- Align the print head.
- Make sure the product is not printing while tilted or at an angle.

**Parent topic:** [Solving Page Layout and Content Problems](#)

**Related concepts**

[Print Head Alignment](#)

**Related tasks**

[Selecting Basic Print Settings - Mac](#)

[Selecting Basic Print Settings - Windows](#)

**Related topics**

[Loading Paper](#)

## Solving Print Quality Problems

Check these sections if your printouts have problems with print quality, but your image looks fine on your computer screen.

**Note:** When printing using AirPrint, the available print settings are different from those covered in this manual. See the Apple website for details.

[White or Dark Lines in Printout](#)  
[Blurry or Smearred Printout](#)  
[Faint Printout or Printout Has Gaps](#)  
[Grainy Printout](#)  
[Incorrect Colors](#)

**Parent topic:** [Solving Problems](#)

## White or Dark Lines in Printout

If you notice white or dark lines in your prints (also called banding), try these solutions before you reprint:

- Run a nozzle check to see if any of the print head nozzles are clogged. Then clean the print head, if necessary.
- Make sure the paper type setting matches the type of paper you loaded.
- Make sure you loaded the printable side of the paper correctly for your product.
- Turn off any high speed settings in your product software.
- Align the print head.
- You may need to refill the ink. Visually check the ink levels.
- If you have not used the product for a long time, run the Power Cleaning utility.

**Note:** Power Cleaning consumes a lot of ink, so run this utility only if you cannot improve print quality by cleaning the print head.

**Parent topic:** [Solving Print Quality Problems](#)

### Related concepts

[Print Head Nozzle Check](#)  
[Print Head Cleaning](#)  
[Print Head Alignment](#)  
[Power Cleaning](#)

### Related references

[Paper or Media Type Settings - Printer Software](#)

### Related tasks

[Selecting Additional Layout and Print Options - Windows](#)  
[Selecting Printing Preferences - Mac](#)

## Related topics

[Refilling Ink](#)

[Loading Paper](#)

## Blurry or Smearred Printout

If your printouts are blurry or smearred, try these solutions:

- Make sure your paper is not damp, curled, old, or loaded incorrectly in your product.
- Use a support sheet with special paper, or load special paper one sheet at a time.
- Make sure your paper meets the specifications for your product.
- Use Epson papers to ensure proper saturation and absorption of genuine Epson inks.
- Make sure the paper type setting in your product software matches the type of paper you loaded.
- Make sure you loaded the printable side of the paper correctly for your product.
- If you are printing on thick paper or envelopes, turn on the **Thick Paper** setting from the control panel or select **Thick Paper and Envelopes** in the Extended Settings of the printer software. (Turning this setting on will decrease print speed.)
- Remove each sheet from the output tray as it is printed.
- Avoid handling printouts on glossy paper right after printing to allow the ink to set.
- Turn off any high speed settings in your product software.
- If you print on both sides of a sheet of paper, smudges may appear on the reverse side of heavily saturated or dark images. If one side of a sheet will contain a lighter image or text, print that side first. Adjust the **Print Density** and/or **Increase Ink Drying Time** settings.
- The ink levels may be low and you may need to refill the ink. Visually check the ink levels.
- Run a nozzle check to see if any of the print head nozzles are clogged. Then clean the print head, if necessary.
- Align the print head.
- Clean the paper path.
- If you printed when the ink levels were too low to be seen in the ink tank windows, refill the ink tanks to the upper lines and run the Power Cleaning utility. Then run a nozzle check to see if print quality has improved.
- If you have not used the product for a long time, run the Power Cleaning utility.

**Note:** Power Cleaning consumes a lot of ink, so run this utility only if you cannot improve print quality by cleaning the print head.

**Note:** Your product will not operate properly while tilted at an angle. Place it on a flat, stable surface that extends beyond the base of the product in all directions.

**Parent topic:** [Solving Print Quality Problems](#)

**Related concepts**

[Print Head Nozzle Check](#)

[Print Head Cleaning](#)

[Print Head Alignment](#)

[Power Cleaning](#)

**Related references**

[Paper Specifications](#)

**Related tasks**

[Selecting Basic Print Settings - Windows](#)

[Selecting Additional Layout and Print Options - Windows](#)

[Selecting Double-sided Printing Settings - Windows](#)

[Selecting Basic Print Settings - Mac](#)

[Selecting Printing Preferences - Mac](#)

[Selecting Double-sided Printing Settings - Mac](#)

[Cleaning the Paper Path](#)

**Related topics**

[Loading Paper](#)

## Faint Printout or Printout Has Gaps

If your printouts are faint or have gaps, try these solutions:

- Run a nozzle check to see if any of the print head nozzles are clogged. Then clean the print head, if necessary.
- The ink levels may be low. Visually check the ink levels.
- Make sure the paper type setting matches the type of paper you loaded.
- Make sure your paper is not damp, curled, old, or loaded incorrectly in your product.
- Align the print head.

- Clean the paper path.
- If you have not used the product for a long time, run the Power Cleaning utility.

**Note:** Power Cleaning consumes a lot of ink, so run this utility only if you cannot improve print quality by cleaning the print head.

**Parent topic:** [Solving Print Quality Problems](#)

**Related concepts**

[Print Head Nozzle Check](#)

[Print Head Cleaning](#)

[Print Head Alignment](#)

[Power Cleaning](#)

**Related references**

[Paper or Media Type Settings - Printer Software](#)

**Related tasks**

[Cleaning the Paper Path](#)

**Related topics**

[Refilling Ink](#)

[Loading Paper](#)

## Grainy Printout

If your printouts are grainy, try these solutions:

- Make sure you loaded the printable side of the paper correctly for your product.
- Select a higher print quality setting and turn off any high speed settings in your product software.
- Run a nozzle check to see if any of the print head nozzles are clogged. Then clean the print head, if necessary.
- Align the print head.
- You may need to increase the image resolution or print a smaller size; see your software documentation.

**Note:** Images from the Internet may be low resolution and not result in a high quality printout.

- If you enlarged the image size in an image-editing program, you need to increase the image resolution setting to retain a high image quality. Increase the image resolution by the same amount you increase the image size. For example, if the image resolution is 300 dpi (dots per inch) and you will double the image size for printing, change the resolution setting to 600 dpi.

**Note:** Higher resolution settings result in larger file sizes, which take longer to process and print. Consider the limitations of your computer system when selecting a resolution, and select the lowest possible resolution that produces acceptable quality to keep file sizes manageable.

**Parent topic:** [Solving Print Quality Problems](#)

**Related concepts**

[Print Head Nozzle Check](#)

[Print Head Cleaning](#)

[Print Head Alignment](#)

**Related tasks**

[Selecting Basic Print Settings - Windows](#)

[Selecting Additional Layout and Print Options - Windows](#)

[Selecting Basic Print Settings - Mac](#)

[Selecting Printing Preferences - Mac](#)

## Incorrect Colors

If your printouts have incorrect colors, try these solutions:

- Make sure the paper type setting matches the paper you loaded.
- Make sure the **Black/Grayscale** or **Grayscale** setting is not selected in your printer software.
- Run a nozzle check to see if any of the print head nozzles are clogged. Then clean the print head, if necessary.
- The ink levels may be low and you may need to refill the ink. Visually check the ink levels.
- If you printed when the ink levels were too low to be seen in the ink tank windows, refill the ink tanks to the upper lines and run the Power Cleaning utility. Then run a nozzle check to see if print quality has improved.
- After you print, the colors in your printout need time to set as the ink dries. During this time, the colors may look different than you expect. To speed up drying time, do not stack your printouts on top of each other.

- Your printed colors can never exactly match your on-screen colors. However, you can use a color management system to get as close as possible. Try using the color management options in your printer software.
- For best results, use genuine Epson ink and paper.
- If you have not used the product for a long time, run the Power Cleaning utility.

**Note:** Power Cleaning consumes a lot of ink, so run this utility only if you cannot improve print quality by cleaning the print head.

**Parent topic:** [Solving Print Quality Problems](#)

**Related concepts**

[Print Head Nozzle Check](#)

[Print Head Cleaning](#)

[Power Cleaning](#)

**Related tasks**

[Selecting Basic Print Settings - Windows](#)

[Selecting Additional Layout and Print Options - Windows](#)

[Selecting Basic Print Settings - Mac](#)

[Managing Color - Mac](#)

**Related topics**

[Refilling Ink](#)

## Solving Scanning Problems

Check these solutions if you have problems scanning with your product.

[Scanning Software Does Not Operate Correctly](#)

[Cannot Start Epson Scan 2](#)

**Parent topic:** [Solving Problems](#)

## Scanning Software Does Not Operate Correctly

If your scanning software does not operate correctly, try these solutions:

- Make sure your computer has adequate memory and meets the system requirements for your operating system.

- Make sure your computer is not running in a power-saving mode, such as sleep or standby. If so, wake your system and restart your scanning software.
- If you upgraded your operating system but did not reinstall your scanning software, try reinstalling it.
- In Windows, make sure your product is listed as a valid device in the **Scanners and Cameras** control panel.

**Parent topic:** [Solving Scanning Problems](#)

**Related concepts**

[Uninstall Your Product Software](#)

**Related references**

[Windows System Requirements](#)

[Mac System Requirements](#)

## Cannot Start Epson Scan 2

If you cannot start Epson Scan 2, try these solutions:

- Make sure your product is turned on and any interface cables are securely connected at both ends.
- Make sure Epson Scan 2 is selected as your scanning program.
- Make sure your computer is not running in a power-saving mode, such as sleep or standby. If so, wake your system and restart Epson Scan 2.
- Check the connection setting and test the connection using Epson Scan 2 Utility:

**Windows 10:** Click  and select **EPSON > Epson Scan 2 Utility**. Make sure the correct product is selected. If necessary, select the **Other** tab and click **Reset**.

**Windows 8.x:** Navigate to the **Apps** screen and select **Epson Scan 2 Utility**. Make sure the correct product is selected. If necessary, select the **Other** tab and click **Reset**.

**Windows (other versions):** Click  or **Start > All Programs** or **Programs > EPSON > Epson Scan 2 > Epson Scan 2 Utility**. Make sure the correct product is selected. If necessary, select the **Other** tab and click **Reset**.

**Mac:** Open the **Applications** folder, click **Epson Software**, and click **Epson Scan 2 Utility**. Make sure the correct product is selected. If necessary, select the **Other** tab and click **Reset**.

- Make sure you do not have multiple versions of Epson Scan 2 installed. If you do, uninstall both versions and install one version.
- If you upgraded your operating system but did not reinstall Epson Scan 2, try reinstalling it.

**Parent topic:** [Solving Scanning Problems](#)

**Related tasks**

[Placing Originals on the Scanner Glass](#)

[Starting a Scan from a Scanning Program](#)

## Solving Scanned Image Quality Problems

Check these sections if a scanned image on your computer screen has a quality problem.

[Image Consists of a Few Dots Only](#)

[Line of Dots Appears in All Scanned Images](#)

[Straight Lines in an Image Appear Crooked](#)

[Image is Distorted or Blurry](#)

[Image Colors are Patchy at the Edges](#)

[Image is Too Dark](#)

[Back of Original Image Appears in Scanned Image](#)

[Ripple Patterns Appear in an Image](#)

[Image is Scanned Upside-Down](#)

[Scanned Image Colors Do Not Match Original Colors](#)

[Scan Area is Not Adjustable in Thumbnail Preview](#)

[Scanned Image Edges are Cropped](#)

**Parent topic:** [Solving Problems](#)

### Image Consists of a Few Dots Only

If your scanned image consists only of a few dots, try these solutions:

- Make sure you placed your original for scanning facing the correct way.
- If you are scanning using the Epson Scan 2 **Black & White** setting, adjust the **Threshold** setting and scan again.

**Parent topic:** [Solving Scanned Image Quality Problems](#)

**Related tasks**

[Cleaning Your Product](#)

## Line of Dots Appears in All Scanned Images

If a line of dots appears in all your scanned images, clean the scanner glass with a soft, dry, lint-free cloth or use a small amount of glass cleaner on the cloth, if necessary. Paper towels are not recommended.

**Caution:** Do not spray glass cleaner directly on the scanner glass.

**Parent topic:** [Solving Scanned Image Quality Problems](#)

## Straight Lines in an Image Appear Crooked

If straight lines in an original appear crooked in a scanned image, make sure to place your original straight when you scan it.

**Parent topic:** [Solving Scanned Image Quality Problems](#)

### Related tasks

[Placing Originals on the Scanner Glass](#)

## Image is Distorted or Blurry

If a scanned image appears distorted or blurry, try these solutions:

- Make sure your original is not wrinkled or warped. This may prevent the original from laying flat on the scanner glass.
- Do not move your original or your product during scanning.
- Your product will not operate properly while tilted at an angle. Place your product on a flat, stable surface that extends beyond its base in all directions.
- Adjust these Epson Scan 2 settings (if available) and try scanning again:
  - Increase the **Resolution** setting.
  - If the **Image Type** setting is **Black & White**, adjust the **Threshold** setting.
  - Select the **Unsharp Mask** setting.
  - If the **Image Type** setting is **Black & White**, select **Text Enhancement**. If the **Image Type** setting is **Color** or **Grayscale**, change the **Text Enhancement** setting to **High**.

**Parent topic:** [Solving Scanned Image Quality Problems](#)

### Related references

[Additional Scanning Settings - Advanced Settings Tab](#)

## Image Colors are Patchy at the Edges

If you are scanning a thick or warped original, cover its edges with paper to block external light as you scan it.

**Parent topic:** [Solving Scanned Image Quality Problems](#)

## Image is Too Dark

If your scanned image is too dark, try these solutions:

- Select the **Advanced Settings** tab in Epson Scan 2 and adjust the **Brightness** setting.
- Check the brightness and contrast settings of your computer monitor.

**Parent topic:** [Solving Scanned Image Quality Problems](#)

### Related references

[Additional Scanning Settings - Advanced Settings Tab](#)

## Back of Original Image Appears in Scanned Image

If an image from the back of a thin original appears in your scanned image, try these solutions:

- Place a piece of black paper on the back of the original and scan it again.
- Adjust these Epson Scan 2 settings (if available) and try scanning again:
  - Select the **Advanced Settings** tab and adjust the **Brightness** setting.
  - If the **Image Type** is set to **Black & White**, select **Text Enhancement**. If the **Image Type** is set to **Color** or **Grayscale**, change the **Text Enhancement** setting to **High**.

**Parent topic:** [Solving Scanned Image Quality Problems](#)

### Related references

[Additional Scanning Settings - Advanced Settings Tab](#)

## Ripple Patterns Appear in an Image

You may see a ripple pattern (called a moiré) in scanned images of printed documents. This is caused by interference from differing pitches in the scanner's screen and your original's halftone screen. To reduce this effect, adjust these Epson Scan 2 settings (if available) and try scanning again:

- Select the **Descreening** setting.
- Select a lower **Resolution** setting.

**Parent topic:** [Solving Scanned Image Quality Problems](#)

## Related references

[Additional Scanning Settings - Advanced Settings Tab](#)

### Image is Scanned Upside-Down

Your product scans using the **Auto Photo Orientation** setting. This setting checks the preview image for faces, the sky, and other features, and then correctly rotates the photo when it is scanned, if necessary.

If your photo is not oriented correctly using this option, you can turn **Auto Photo Orientation** off and scan again. When Photo Mode is selected, select **Thumbnail Options** from the Main Settings tab. Select **On** or **Off** and scan your document again.

**Note:** **Auto Photo Orientation** will not work when you scan newspapers, magazines, documents, illustrations, or line art, or images smaller than 2 inches (5.1 cm) on any side.

**Parent topic:** [Solving Scanned Image Quality Problems](#)

### Scanned Image Colors Do Not Match Original Colors

Printed colors can never exactly match the colors on your computer monitor because printers and monitors use different color systems: monitors use RGB (red, green, and blue) and printers typically use CMYK (cyan, magenta, yellow, and black).

Check the color matching and color management capabilities of your computer, display adapter, and the software you are using to see if they are affecting the palette of colors you see on your screen.

To adjust the colors in your scanned image, adjust these Epson Scan 2 settings (if available) and try scanning again:

- If the **Image Type** setting is **Color** or **Grayscale**, adjust the **Contrast** setting.
- If the **Image Type** setting is **Black & White** or **Grayscale**, adjust the **Color Enhance** setting.

**Parent topic:** [Solving Scanned Image Quality Problems](#)

### Scan Area is Not Adjustable in Thumbnail Preview

If you cannot adjust the scan area while viewing a Thumbnail preview in Epson Scan, try these solutions:

- Create a scan area by drawing a marquee on your preview image and adjusting it as necessary.
- Switch to Normal preview mode, if available, and preview your image again.

**Parent topic:** [Solving Scanned Image Quality Problems](#)

## Scanned Image Edges are Cropped

If the edges of a scanned image are cropped, make sure your original is placed correctly for scanning. If necessary, move your original away from the edges of the scanner glass slightly.

**Parent topic:** [Solving Scanned Image Quality Problems](#)

### Related tasks

[Placing Originals on the Scanner Glass](#)

## Solving Memory Card Problems

Check these solutions if you have problems using memory cards with your product.

[Memory Card Does Not Fit Into a Slot](#)

[Cannot View or Print Photos from a Memory Card or Device](#)

[Cannot Transfer Photos to or from a Memory Card or Device](#)

**Parent topic:** [Solving Problems](#)

## Memory Card Does Not Fit Into a Slot

If a memory card does not fit properly in a slot, do not force it in. You may need to use an adapter with your memory card.

**Parent topic:** [Solving Memory Card Problems](#)

### Related references

[Memory Card Types](#)

### Related tasks

[Inserting a Memory Card](#)

## Cannot View or Print Photos from a Memory Card or Device

If you cannot view or print photos from a memory card or USB device inserted in your product, try these solutions:

- Make sure your memory card or device is compatible with the product.
- Make sure the files on your memory card or device are in the correct format.
- If you have too many photos on your memory card or device, you may not see all the photos you expect or may be prompted to select a group of photos by date. Reduce the number of photos on your card or select one group of photos at a time. Check the specifications for the maximum number of photos.

**Parent topic:** [Solving Memory Card Problems](#)

## Cannot Transfer Photos to or from a Memory Card or Device

If you have problems transferring photos to or from a memory card or USB device inserted in your product, try these solutions:

- Make sure your memory card or device is compatible with the product.
- Make sure your product is securely connected to your computer.
- If you are transferring photos to a memory card, check the memory card's write-protect tab to make sure it is set to allow writing to the card.
- Make sure that the file sharing setting for your product is set correctly.

**Parent topic:** [Solving Memory Card Problems](#)

### Related references

[Memory Card Types](#)

[Memory Card Specifications](#)

[External USB Device Specifications](#)

### Related tasks

[Inserting a Memory Card](#)

[Connecting and Printing from a Camera](#)

[Connecting and Using a USB Flash Drive or External Device](#)

## Solving CD/DVD Problems

Check these sections if you have problems printing on a CD/DVD with your product.

[CD/DVD Jam Problems](#)

[Image Not Centered on CD/DVD](#)

[Ink Smears on CD/DVD](#)

[Faint Image on CD/DVD](#)

**Parent topic:** [Solving Problems](#)

## CD/DVD Jam Problems

If a CD/DVD has jammed in the product and you see an error message, you need to remove the CD/DVD tray:

1. Cancel the print job from your computer, if necessary.

2. Slowly pull the CD/DVD tray out of the product.
3. Clear the error message.
4. If an error is still displayed, turn off the product, wait a moment, and then turn it back on.
5. If you are unable to remove the CD/DVD tray, contact Epson for support.

**Parent topic:** [Solving CD/DVD Problems](#)

## **Image Not Centered on CD/DVD**

If your printed image is not centered on the disc, do one of the following:

- If you are printing from a computer, adjust the print position using the Epson Print CD software. See the Epson Print CD help utility for details.
- If you are printing from the control panel, adjust the printing position using the product menus.

**Parent topic:** [Solving CD/DVD Problems](#)

### **Related tasks**

[Printing Your CD/DVD Design - Windows](#)

[Printing Your CD/DVD Design - Mac](#)

[Printing Photos from a Memory Card Onto a CD/DVD](#)

## **Ink Smears on CD/DVD**

If you notice smeared ink on your disc, try these solutions:

- Make sure you are printing on ink jet-printable CDs or DVDs and that the surface of the disc is dry.
- Handle printed discs carefully and let them dry for 24 hours before inserting them in a drive.
- Adjust the print quality using the Epson Print CD software. See the Epson Print CD help utility for details.

**Parent topic:** [Solving CD/DVD Problems](#)

### **Related tasks**

[Printing Your CD/DVD Design - Windows](#)

[Printing Your CD/DVD Design - Mac](#)

## **Faint Image on CD/DVD**

If your printed image is faint, adjust the print quality using the Epson Print CD software. See the Epson Print CD help utility for details.

**Parent topic:** [Solving CD/DVD Problems](#)

**Related tasks**

[Printing Your CD/DVD Design - Windows](#)

[Printing Your CD/DVD Design - Mac](#)

## Uninstall Your Product Software

If you have a problem that requires you to uninstall and re-install your software, follow the instructions for your operating system.



[Uninstalling Product Software - Windows](#)

[Uninstalling Product Software - Mac](#)

**Parent topic:** [Solving Problems](#)

## Uninstalling Product Software - Windows

You can uninstall and then re-install your product software to solve certain problems.

1. Turn off the product.
2. Disconnect any interface cables.
3. Do one of the following:
  - **Windows 10:** Click  and select  (Settings) > **Apps** > **Apps & features**. Then select the program you want to uninstall and select **Uninstall**.
  - **Windows 8.x:** Navigate to the **Apps** screen and select **Control Panel** > **Programs** > **Programs and Features**. Select the uninstall option for your Epson product, then select **Uninstall/Change**.

**Note:** If you see a **User Account Control** window, click **Yes** or **Continue**.

Select your product again, if necessary, then select **OK**, and click **Yes** to confirm the uninstallation.

- **Windows (other versions):** Click  or **Start**, and select **All Programs** or **Programs**. Select **EPSON**, select your product, then click **EPSON Printer Software Uninstall**.

**Note:** If you see a **User Account Control** window, click **Yes** or **Continue**.

In the next window, select your product and click **OK**. Then follow any on-screen instructions.

4. Do one of the following to uninstall Epson Event Manager, then follow any on-screen instructions:
  - **Windows 10/8.x:** Select **Epson Event Manager** and click **Uninstall**.
  - **Windows 7/Windows Vista:** Open the Windows **Control Panel** utility. Select **Programs and Features**. (In Classic view, select **Programs** and click **Uninstall a program**.) Select **Epson Event Manager** and click **Uninstall/Change**.
5. Do one of the following to uninstall Epson Scan 2, then follow any on-screen instructions:
  - **Windows 10:** Select **Epson Scan 2** and click **Uninstall**.
  - **Windows 8.x/Windows 7/Windows Vista:** Select **Epson Scan 2** and click **Uninstall/Change**.
6. Restart your computer, then see the *Start Here* sheet to re-install your software.

**Note:** If you find that re-installing your product software does not solve a problem, contact Epson.

**Parent topic:** [Uninstall Your Product Software](#)

## Uninstalling Product Software - Mac

In most cases, you do not need to uninstall your product software before re-installing it. However, you can download the Uninstaller utility from the Epson support website to uninstall your product software as described here.

**Note:** If you find that re-installing your product software does not solve a problem, contact Epson.

1. To download the Uninstaller utility, visit [epson.com/support](http://epson.com/support) (U.S.), [epson.ca/support](http://epson.ca/support) (Canada), or [epson.com.jm/support](http://epson.com.jm/support) (Caribbean) and select your product.
2. Click **Downloads**.
3. Select your operating system, click **Utilities**, locate the Uninstaller utility, and click **Download**.
4. Run the file you downloaded.
5. Double-click the **Uninstaller** icon.
6. In the Epson Uninstaller screen, select the checkbox for each software program you want to uninstall.
7. Click **Uninstall**.
8. Follow the on-screen instructions to uninstall the software.
9. Reinstall your product software.

**Note:** If you uninstall the printer driver and your product name remains in the **Print & Fax, Print & Scan,** or **Printers & Scanners** window, select your product name and click the – (remove) icon to remove it.

**Parent topic:** [Uninstall Your Product Software](#)

## Where to Get Help

If you need to contact Epson for technical support services, use the following support options.

### Internet Support

Visit Epson's support website at [epson.com/support](http://epson.com/support) (U.S.), [epson.ca/support](http://epson.ca/support) (Canada), or [epson.com.jm/support](http://epson.com.jm/support) (Caribbean) and select your product for solutions to common problems. You can download drivers and documentation, get FAQs and troubleshooting advice, or e-mail Epson with your questions.

### Speak to a Support Representative

Before you call Epson for support, please have the following information ready:

- Product name
- Product serial number (located on a label on the product)
- Proof of purchase (such as a store receipt) and date of purchase
- Computer configuration
- Description of the problem

Then call:

- U.S.: (562) 276-4382, 6 AM to 8 PM, Pacific Time, Monday through Friday, and 7 AM to 4 PM, Pacific Time, Saturday
- Canada: (905) 709-3839, 6 AM to 8 PM, Pacific Time, Monday through Friday, and 7 AM to 4 PM, Pacific Time, Saturday

Days and hours of support are subject to change without notice. Toll or long distance charges may apply.

### Purchase Supplies and Accessories

You can purchase genuine Epson ink and paper at [epson.com](http://epson.com) (U.S. sales) or [epson.ca](http://epson.ca) (Canadian sales). You can also purchase supplies from an Epson authorized reseller. To find the nearest one, call 800-GO-EPSON (800-463-7766) in the U.S. or 800-807-7766 in Canada.

**Parent topic:** [Solving Problems](#)

---

# Technical Specifications

These sections list the technical specifications for your product.

**Note:** Epson offers a recycling program for end of life Epson products. Please go to [this site](#) (U.S) or [this site](#) (Canada) for information on how to return your Epson products for proper disposal.

[Windows System Requirements](#)

[Mac System Requirements](#)

[Paper Specifications](#)

[Printable Area Specifications](#)

[Scanning Specifications](#)

[Ink Specifications](#)

[Memory Card Specifications](#)

[External USB Device Specifications](#)

[Dimension Specifications](#)

[Electrical Specifications](#)

[Environmental Specifications](#)

[Interface Specifications](#)

[Network Interface Specifications](#)

[Safety and Approvals Specifications](#)

## Windows System Requirements

To use your product and its software, your computer should use one of these Microsoft operating systems:

- Windows 10
- Windows 8.x
- Windows 7
- Windows Vista

**Note:** For the latest product software available for your operating system, visit the Epson support site at [epson.com/support](#) (U.S.), [epson.ca/support](#) (Canada), or [epson.com.jm/support](#) (Caribbean), select your product, and select **Downloads**.

Parent topic: [Technical Specifications](#)

## Mac System Requirements

To use your product and its software, your Mac should use one of these operating systems:

- macOS 10.12.x
- OS X 10.11.x
- OS X 10.10.x
- OS X 10.9.x
- OS X 10.8.x
- OS X 10.7.x
- OS X 10.6.8

**Note:** For the latest product software available for your operating system, visit the Epson support site at [epson.com/support](http://epson.com/support) (U.S.), [epson.ca/support](http://epson.ca/support) (Canada), or [epson.com.jm/support](http://epson.com.jm/support) (Caribbean), select your product, and select **Downloads**.

Parent topic: [Technical Specifications](#)

## Paper Specifications

**Note:** Since the quality of any particular brand or type of paper may be changed by the manufacturer at any time, Epson cannot guarantee the quality of any non-Epson brand or type of paper. Always test a sample of paper stock before purchasing large quantities or printing large jobs.

## Single-sheets

<b>Size</b>	A3 (11.7 × 16.5 inches [297 × 420 mm]) A4 (8.3 × 11.7 inches [210 × 297 mm]) A6 (4.1 × 5.8 inches [105 × 148 mm]) Letter (8.5 × 11 inches [216 × 279 mm]) Legal (8.5 × 14 inches [216 × 356 mm]) 4 × 6 inches (102 × 152 mm) 5 × 7 inches (127 × 178 mm) 8 × 10 inches (203 × 254 mm) 11 × 17 inches (279 × 432 mm) 16:9 wide (4 × 7.1 inches [102 × 181 mm])
<b>Paper types</b>	Plain paper and paper distributed by Epson
<b>Weight</b>	Plain paper: 17 lb (64 g/m <sup>2</sup> ) to 24 lb (90 g/m <sup>2</sup> )

## Envelopes

<b>Size</b>	No. 10 (4.1 × 9.5 inches [105 × 241 mm])
<b>Paper types</b>	Plain bond paper
<b>Weight</b>	20 lb (75 g/m <sup>2</sup> ) to 24 lb (90 g/m <sup>2</sup> )

Parent topic: [Technical Specifications](#)

## Printable Area Specifications

**Note:** When printing borderless, quality may decline in the expanded printable area.

### Single sheets – normal printing

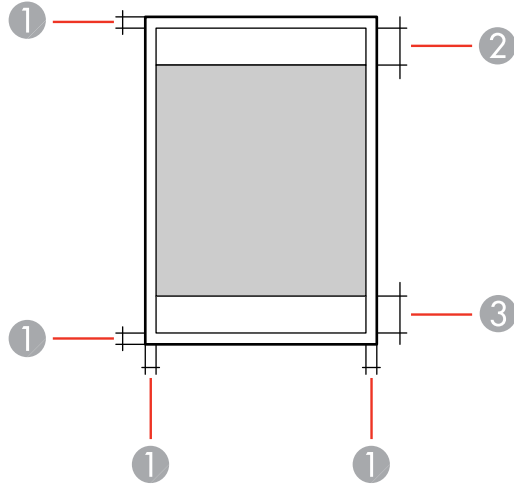

- 1 Margin: 0.12 inch (3 mm) minimum
- 2 Reduced print quality area/top: 1.61 inch (41 mm) minimum
- 3 Reduced print quality area/bottom: 1.46 inch (37 mm) minimum

### Single sheets – borderless printing

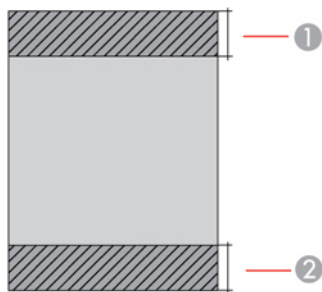

- 1 Reduced print quality area/top: 1.73 inch (44 mm) minimum
- 2 Reduced print quality area/bottom: 1.57 inch (40 mm) minimum

## Envelopes

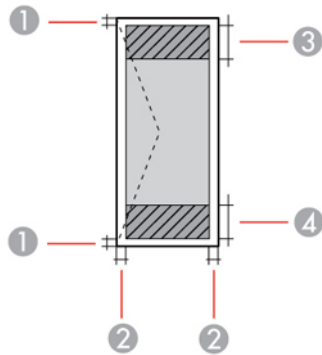

- 1 Left/right margins: 0.12 inch (3 mm) minimum
- 2 Top/bottom: 0.20 inch (5 mm) minimum
- 3 Reduced print quality area/right: 0.71 inch (18 mm) minimum
- 4 Reduced print quality area/left: 1.61 inch (41 mm) minimum

## CD/DVD

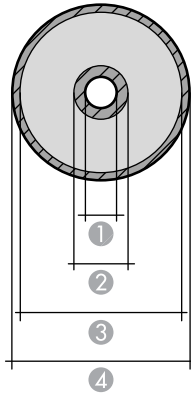

- 1 Inner margin: 0.71 inch (18 mm) minimum
- 2 Inner reduced print quality area: 1.69 inch (43 mm) minimum

- 3 Outer reduced print quality area: 4.57 inches (116 mm) minimum
- 4 Maximum outer margin: 4.72 inches (120 mm)

Parent topic: [Technical Specifications](#)

## Scanning Specifications

<b>Scanner type</b>	Flatbed
<b>Photoelectric device</b>	CIS
<b>Document size</b>	Maximum: 8.5 × 11.7 inches (216 × 297 mm) Scanner glass: US letter or A4
<b>Scanning resolution</b>	1200 dpi (main scan) 2400 dpi (sub scan)
<b>Color Depth</b>	Color: 48 bits per pixel internal (16 bits per pixel per color internal) 24 bits per pixel external (8 bits per pixel per color external) Grayscale: 16 bits per pixel internal 8 bits per pixel internal Black-and-white: 16 bits per pixel internal 1 bit per pixel external
<b>Light source</b>	LED

Parent topic: [Technical Specifications](#)

## Ink Specifications

**Note:** This product is designed to work with genuine Epson inks. Non-Epson ink or any other ink not specified for this printer could cause damage not covered by Epson's warranties.

The included initial ink bottles must be used for printer setup and are not for resale. The printer ships with full ink bottles and part of the ink from the first bottles is used to charge the print head. Yields vary considerably based on images printed, print settings, paper type, frequency of use and temperature.

<b>Color</b>	Black, Photo Black, Cyan, Magenta, Yellow
<b>Ink life</b>	For best results, use up ink within 6 months of opening an ink bottle
<b>Temperature</b>	Storage: –4 to 104 °F (–20 to 40 °C) 1 month at 104 °F (40 °C) Ink freezes at 5 °F (–15 °C) Ink thaws and is usable after 2 hours at 77 °F (25 °C)

**Parent topic:** [Technical Specifications](#)

**Related concepts**

[Purchase Epson Ink and Maintenance Box](#)

## Memory Card Specifications

**Note:** Cards marked with an asterisk (\*) require an adapter; consult your adapter documentation for details on using it.

<b>Compatible types and maximum capacities</b>	miniSD*: 2GB miniSDHC*: 32GB microSD*: 2GB microSDHC*: 32GB microSDXC*: 64GB SD: 2GB SDHC: 32GB SDXC: 64GB
<b>Voltage requirements</b>	3.3 V type, dual voltage type (3.3 V and 5 V); supply voltage 3.3 V Maximum current: 200 mA

**Parent topic:** [Technical Specifications](#)

## External USB Device Specifications

Do not use devices with the following requirements:

- Dedicated driver
- Security settings, such as password or encryption, etc.
- Built-in USB hub

**Note:** Use only external storage devices with independent AC power sources. External storage devices that are powered via USB are not recommended. Epson cannot guarantee the operation of externally connected devices.

<b>CD-ROM/CD-R drive</b>	700MB maximum capacity CD-RW is not supported
<b>DVD-ROM/DVD-R drive</b>	4.7GB maximum capacity DVD-RW, DVD+R, DVD+RW, DVD-RAM, and Blu-ray Disc are not supported
<b>Magneto-optical drive</b>	1.3GB
<b>Hard disk and USB flash drives</b>	2TB Formatted in FAT, FAT32, or exFAT.

Parent topic: [Technical Specifications](#)

## Dimension Specifications

<b>Height</b>	Stored: 6.6 inches (168 mm) Printing: 17.8 inches (453 mm)
<b>Width</b>	Stored: 20.7 inches (526 mm) Printing: 20.7 inches (526 mm)
<b>Depth</b>	Stored: 16.3 inches (415 mm) Printing: 29.3 inches (743 mm)

**Weight** 23.1 lb (10.5 kg)  
(without ink, power cord, and  
CD/DVD tray)

Parent topic: [Technical Specifications](#)

## Electrical Specifications

**Power supply rating** 100 to 120 V  
**Rated frequency range** 50/60 Hz  
**Rated current** 0.5 A  
**Power consumption** Standalone copying: Approximately 13 W (ISO/IEC24712)  
Ready mode: Approximately 6.4 W  
Sleep mode: Approximately 0.9 W  
Power off mode: Approximately 0.1 W

Parent topic: [Technical Specifications](#)

## Environmental Specifications

**Temperature** Operating: 50 to 95 °F (10 to 35 °C)  
Storage: -4 to 104 °F (-20 to 40 °C)  
1 month at 104 °F (40 °C)  
**Humidity** Operating: 20 to 80% RH  
(without condensation) Storage: 5 to 85% RH

Parent topic: [Technical Specifications](#)

## Interface Specifications

**Interface type** Hi-Speed USB (Device Class for computers)  
Hi-Speed USB (for Mass storage class for external storage and  
PictBridge devices)

**Note:** Epson cannot guarantee the operation of externally connected devices.

**Parent topic:** [Technical Specifications](#)

## Network Interface Specifications

### Wi-Fi

<b>Wireless LAN standard</b>	IEEE 802.11 b/g/n
<b>Wireless security</b>	WPA2-PSK (AES); WPA2 compliant WEP (64/128 bit)
<b>Frequency band</b>	2.4 GHz
<b>Communication mode</b>	Infrastructure mode Wi-Fi Direct (not supported for IEEE 802.11b)

**Note:** Wireless LAN standard complies with either IEEE 802.11 b/g or IEEE 802.11 b/g/n, depending on purchase location.

### Ethernet

<b>Standard</b>	IEEE802.3i (10BASE-T); to prevent risk of radio interference, use a Category-5e or higher shielded twisted pair cable IEEE802.3u (100BASE-TX) IEEE802.3az (Energy Efficient Ethernet); connected device should be IEEE802.3az compliant
<b>Communication mode</b>	Auto, 10Mbps Full duplex, 10Mbps Half duplex, 100Mbps Full duplex, 100Mbps Half duplex
<b>Connector</b>	RJ-45

### Security Protocol

SSL/TLS: HTTPS Server/Client or IPPS

**Parent topic:** [Technical Specifications](#)

## Safety and Approvals Specifications

### United States

Safety: UL60950-1

EMC: FCC part 15 Subpart B class B

### Canada

Safety: CAN/CSA C22.2 No. 60950-1

EMC: CAN/CSA-CEI/IEC CISPR 22 Class B

This equipment contains the following wireless module:

- Manufacturer: Askey Computer Corporation.
- Type: WLU6320-D69 (RoHS)

This product conforms to Part 15 of FCC Rules and RSS-210 of the IC Rules. Epson cannot accept responsibility for any failure to satisfy the protection requirements resulting from a non-recommended modification of the product. Operation is subject to the following two conditions: (1) this device may not cause harmful interference, and (2) this device must accept any interference received, including interference that may cause undesired operation of the device.

To prevent radio interference to the licensed service, this device is intended to be operated indoors and away from windows to provide maximum shielding. Equipment (or its transmit antenna) that is installed outdoors is subject to licensing.

This equipment complies with FCC/IC radiation exposure limits set forth for an uncontrolled environment and meets the FCC radio frequency (RF) Exposure Guidelines in Supplement C to OET65 and RSS-102 of the IC radio frequency (RF) Exposure rules. This equipment should be installed and operated so that the radiator is kept at least 7.9 inches (20 cm) or more away from a person's body (excluding extremities: hands, wrists, feet and ankles).

**Parent topic:** [Technical Specifications](#)

---

## Notices

Check these sections for important notices about your product.

**Note:** Epson offers a recycling program for end of life Epson products. Please go to [this site](#) (U.S) or [this site](#) (Canada) for information on how to return your Epson products for proper disposal.

[Important Safety Instructions](#)

[FCC Compliance Statement](#)

[Binding Arbitration and Class Waiver](#)

[Trademarks](#)

[Copyright Notice](#)

## Important Safety Instructions

Before using your Epson product, read and follow these safety instructions.

[General Product Safety Instructions](#)

[Wireless Connection Safety Instructions](#)

[LCD Screen Safety Instructions](#)

**Parent topic:** [Notices](#)

## General Product Safety Instructions

- Be sure to follow all warnings and instructions marked on the product.
- Use only the type of power source indicated on the product's label.
- Use only the power cord that comes with the product. Use of another cord may cause fires or shock. Do not use the cord with any other equipment.
- Place the product near a wall outlet where the plug can be easily unplugged.
- Avoid plugging the product into an outlet on the same circuit as a photo copier or air control system that regularly switches on and off, or on an outlet controlled by a wall switch or timer.
- Do not let the power cord become damaged or frayed. Place it to avoid abrasions, cuts, fraying, crimping, and kinking. Do not place objects on top of it and do not allow it to be stepped on or run over. Be careful to keep the cord straight at each end.
- If you use an extension cord with the product, make sure the total ampere rating of the devices plugged into the extension cord does not exceed the cord's ampere rating. Also, make sure the total

ampere rating of all devices plugged into the wall outlet does not exceed the wall outlet's ampere rating.

- Always turn off the product using the power button, and wait until the power light stops flashing before unplugging the product or cutting off power to the electrical outlet.
- If you will not be using the product for a long period, unplug the power cord from the electrical outlet.
- Place the product on a flat, stable surface that extends beyond its base in all directions. It will not operate properly if it is tilted or at an angle.
- Allow space behind the product for the cables, and space above the product so that you can fully raise the document cover.
- Leave enough space in front of the product for the paper to be fully ejected.
- Avoid locations that are subject to rapid changes in heat or humidity, shocks or vibrations, or dust.
- Do not place or store the product outdoors.
- Do not place the product near excessive heat sources or in direct sunlight.
- Leave enough room around the product for sufficient ventilation. Do not block or cover openings in the case or insert objects through the slots.
- Keep the product away from potential sources of electromagnetic interference, such as loudspeakers or the base units of cordless telephones.
- When connecting the product to a computer or other device with a cable, ensure the correct orientation of the connectors. Each connector has only one correct orientation. Inserting a connector in the wrong orientation may damage both devices connected by the cable.
- Do not touch the flat white cable inside the product.
- Do not move the print head by hand; this may damage the product.
- Do not spill liquid on the product or use the product with wet hands.
- Do not use aerosol products that contain flammable gases inside or around the product. Doing so may cause fire.
- Do not press too hard on the document table when placing originals.
- Do not open the scanner section while the product is copying, printing, scanning, or performing any other functions.
- Be careful not to trap your fingers when closing the document cover or scanner.
- Except as specifically explained in your documentation, do not attempt to service or disassemble the product yourself.

- Unplug the product and refer servicing to qualified service personnel under the following conditions: if the power cord or plug is damaged; if liquid has entered the product; if the product has been dropped or the case damaged; if the product does not operate normally or exhibits a distinct change in performance. Adjust only those controls that are covered by the operating instructions.
- Before transporting the product, make sure that the print head is in the home (far right) position.
- When storing or transporting the product, do not tilt it, stand it on its side, or turn it upside down; otherwise ink may leak.

**Parent topic:** [Important Safety Instructions](#)

## Wireless Connection Safety Instructions

Radio waves from this product may adversely affect the operation of medical equipment or automatically controlled devices, such as pacemakers, automatic doors or fire alarms. When using this product near such devices or inside a medical facility, follow the directions from authorized staff members at the facility, and follow all posted warnings and directions on the device to avoid causing an accident.

**Parent topic:** [Important Safety Instructions](#)

## LCD Screen Safety Instructions

- Use only a dry, soft cloth to clean the LCD screen. Do not use liquid or chemical cleansers.
- If the LCD screen is damaged, contact Epson. If the liquid crystal solution gets on your hands, wash them thoroughly with soap and water. If the liquid crystal solution gets into your eyes, flush them immediately with water. If discomfort or vision problems remain after a thorough flushing, see a doctor immediately.
- Do not press too hard on the LCD screen or subject it to heavy impacts.
- Do not use a pointy or sharp object, such as a pen or your fingernail, to operate the LCD screen.
- If the LCD screen chips or cracks, do not touch or attempt to remove the broken pieces; contact Epson for support.

**Parent topic:** [Important Safety Instructions](#)

## FCC Compliance Statement

### For United States Users

This equipment has been tested and found to comply with the limits for a Class B digital device, pursuant to Part 15 of the FCC Rules. These limits are designed to provide reasonable protection against harmful interference in a residential installation. This equipment generates, uses, and can radiate radio frequency energy and, if not installed and used in accordance with the instructions, may cause harmful

interference to radio or television reception. However, there is no guarantee that interference will not occur in a particular installation. If this equipment does cause interference to radio and television reception, which can be determined by turning the equipment off and on, the user is encouraged to try to correct the interference by one or more of the following measures:

- Reorient or relocate the receiving antenna.
- Increase the separation between the equipment and receiver.
- Connect the equipment into an outlet on a circuit different from that to which the receiver is connected.
- Consult the dealer or an experienced radio/TV technician for help.

### **WARNING**

The connection of a non-shielded equipment interface cable to this equipment will invalidate the FCC Certification or Declaration of this device and may cause interference levels which exceed the limits established by the FCC for this equipment. It is the responsibility of the user to obtain and use a shielded equipment interface cable with this device. If this equipment has more than one interface connector, do not leave cables connected to unused interfaces. Changes or modifications not expressly approved by the manufacturer could void the user's authority to operate the equipment.

### **For Canadian Users**

CAN ICES-3(B)/NMB-3(B)

Parent topic: [Notices](#)

## **Binding Arbitration and Class Waiver**

### **1. DISPUTES, BINDING INDIVIDUAL ARBITRATION, AND WAIVER OF CLASS ACTIONS AND CLASS ARBITRATIONS**

**1.1 Disputes.** The terms of this Section 1 shall apply to all Disputes between you and Epson. The term "Dispute" is meant to have the broadest meaning permissible under law and includes any dispute, claim, controversy or action between you and Epson arising out of or relating to this Agreement, Epson branded products (hardware and including any related software), or other transaction involving you and Epson, whether in contract, warranty, misrepresentation, fraud, tort, intentional tort, statute, regulation, ordinance, or any other legal or equitable basis. "DISPUTE" DOES NOT INCLUDE IP CLAIMS, or more specifically, a claim or cause of action for (a) trademark infringement or dilution, (b) patent infringement, (c) copyright infringement or misuse, or (d) trade secret misappropriation (an "IP Claim"). You and Epson also agree, notwithstanding Section 1.6, that a court, not an arbitrator, may decide if a claim or cause of action is for an IP Claim.

**1.2 Binding Arbitration.** You and Epson agree that all Disputes shall be resolved by binding arbitration according to this Agreement. **ARBITRATION MEANS THAT YOU WAIVE YOUR RIGHT TO A JUDGE**

**OR JURY IN A COURT PROCEEDING AND YOUR GROUNDS FOR APPEAL ARE LIMITED.**

Pursuant to this Agreement, binding arbitration shall be administered by JAMS, a nationally recognized arbitration authority, pursuant to its code of procedures then in effect for consumer related disputes, but excluding any rules that permit joinder or class actions in arbitration (for more detail on procedure, see Section 1.6 below). You and Epson understand and agree that (a) the Federal Arbitration Act (9 U.S.C. §1, et seq.) governs the interpretation and enforcement of this Section 1, (b) this Agreement memorializes a transaction in interstate commerce, and (c) this Section 1 shall survive termination of this Agreement.

**1.3 Pre-Arbitration Steps and Notice.** Before submitting a claim for arbitration, you and Epson agree to try, for sixty (60) days, to resolve any Dispute informally. If Epson and you do not reach an agreement to resolve the Dispute within the sixty (60) days, you or Epson may commence an arbitration. Notice to Epson must be addressed to: Epson America, Inc., ATTN: Legal Department, 3840 Kilroy Airport Way, Long Beach, CA 90806 (the "Epson Address"). The Dispute Notice to you will be sent to the most recent address Epson has in its records for you. For this reason, it is important to notify us if your address changes by emailing us at [EAILEgal@ea.epson.com](mailto:EAILEgal@ea.epson.com) or writing us at the Epson Address above. Notice of the Dispute shall include the sender's name, address and contact information, the facts giving rise to the Dispute, and the relief requested (the "Dispute Notice"). Following receipt of the Dispute Notice, Epson and you agree to act in good faith to resolve the Dispute before commencing arbitration.

**1.4 Small Claims Court.** Notwithstanding the foregoing, you may bring an individual action in the small claims court of your state or municipality if the action is within that court's jurisdiction and is pending only in that court.

**1.5 WAIVER OF CLASS ACTIONS AND CLASS ARBITRATIONS. YOU AND EPSON AGREE THAT EACH PARTY MAY BRING DISPUTES AGAINST THE OTHER PARTY ONLY IN AN INDIVIDUAL CAPACITY, AND NOT AS A PLAINTIFF OR CLASS MEMBER IN ANY CLASS OR REPRESENTATIVE PROCEEDING, INCLUDING WITHOUT LIMITATION FEDERAL OR STATE CLASS ACTIONS, OR CLASS ARBITRATIONS. CLASS ACTION LAWSUITS, CLASS-WIDE ARBITRATIONS, PRIVATE ATTORNEY-GENERAL ACTIONS, AND ANY OTHER PROCEEDING WHERE SOMEONE ACTS IN A REPRESENTATIVE CAPACITY ARE NOT ALLOWED. ACCORDINGLY, UNDER THE ARBITRATION PROCEDURES OUTLINED IN THIS SECTION, AN ARBITRATOR SHALL NOT COMBINE OR CONSOLIDATE MORE THAN ONE PARTY'S CLAIMS WITHOUT THE WRITTEN CONSENT OF ALL AFFECTED PARTIES TO AN ARBITRATION PROCEEDING.**

**1.6 Arbitration Procedure.** If you or Epson commences arbitration, the arbitration shall be governed by the rules of JAMS that are in effect when the arbitration is filed, excluding any rules that permit arbitration on a class or representative basis (the "JAMS Rules"), available at <http://www.jamsadr.com> or by calling 1-800-352-5267, and under the rules set forth in this Agreement. All Disputes shall be resolved by a single neutral arbitrator, and both parties shall have a reasonable opportunity to participate in the selection of the arbitrator. The arbitrator is bound by the terms of this Agreement. The arbitrator, and not any federal, state or local court or agency, shall have exclusive authority to resolve all disputes arising

out of or relating to the interpretation, applicability, enforceability or formation of this Agreement, including any claim that all or any part of this Agreement is void or voidable. Notwithstanding this broad delegation of authority to the arbitrator, a court may determine the limited question of whether a claim or cause of action is for an IP Claim, which is excluded from the definition of "Disputes" in Section 1.1 above. The arbitrator shall be empowered to grant whatever relief would be available in a court under law or in equity. The arbitrator may award you the same damages as a court could, and may award declaratory or injunctive relief only in favor of the individual party seeking relief and only to the extent necessary to provide relief warranted by that party's individual claim. In some instances, the costs of arbitration can exceed the costs of litigation and the right to discovery may be more limited in arbitration than in court. The arbitrator's award is binding and may be entered as a judgment in any court of competent jurisdiction.

You may choose to engage in arbitration hearings by telephone. Arbitration hearings not conducted by telephone shall take place in a location reasonably accessible from your primary residence, or in Orange County, California, at your option.

a) Initiation of Arbitration Proceeding. If either you or Epson decides to arbitrate a Dispute, both parties agree to the following procedure:

(i) Write a Demand for Arbitration. The demand must include a description of the Dispute and the amount of damages sought to be recovered. You can find a copy of a Demand for Arbitration at <http://www.jamsadr.com> ("Demand for Arbitration").

(ii) Send three copies of the Demand for Arbitration, plus the appropriate filing fee, to: JAMS, 500 North State College Blvd., Suite 600 Orange, CA 92868, U.S.A.

(iii) Send one copy of the Demand for Arbitration to the other party (same address as the Dispute Notice), or as otherwise agreed by the parties.

b) Hearing Format. During the arbitration, the amount of any settlement offer made shall not be disclosed to the arbitrator until after the arbitrator determines the amount, if any, to which you or Epson is entitled. The discovery or exchange of non-privileged information relevant to the Dispute may be allowed during the arbitration.

c) Arbitration Fees. Epson shall pay, or (if applicable) reimburse you for, all JAMS filings and arbitrator fees for any arbitration commenced (by you or Epson) pursuant to provisions of this Agreement.

d) Award in Your Favor. For Disputes in which you or Epson seeks \$75,000 or less in damages exclusive of attorney's fees and costs, if the arbitrator's decision results in an award to you in an amount greater than Epson's last written offer, if any, to settle the Dispute, Epson will: (i) pay you \$1,000 or the amount of the award, whichever is greater; (ii) pay you twice the amount of your reasonable attorney's fees, if any; and (iii) reimburse you for any expenses (including expert witness fees and costs) that your attorney reasonably accrues for investigating, preparing, and pursuing the Dispute in arbitration. Except as agreed upon by you and Epson in writing, the arbitrator shall determine the amount of fees, costs, and expenses to be paid by Epson pursuant to this Section 1.6d).

e) Attorney's Fees. Epson will not seek its attorney's fees and expenses for any arbitration commenced involving a Dispute under this Agreement. Your right to attorney's fees and expenses under Section 1.6d) above does not limit your rights to attorney's fees and expenses under applicable law; notwithstanding the foregoing, the arbitrator may not award duplicative awards of attorney's fees and expenses.

**1.7 Opt-out. You may elect to opt-out (exclude yourself) from the final, binding, individual arbitration procedure and waiver of class and representative proceedings specified in this Agreement by sending a written letter to the Epson Address within thirty (30) days of your assent to this Agreement (including without limitation the purchase, download, installation of the Software or other applicable use of Epson Hardware, products and services) that specifies (i) your name, (ii) your mailing address, and (iii) your request to be excluded from the final, binding individual arbitration procedure and waiver of class and representative proceedings specified in this Section 1. In the event that you opt-out consistent with the procedure set forth above, all other terms shall continue to apply, including the requirement to provide notice prior to litigation.**

**1.8 Amendments to Section 1.** Notwithstanding any provision in this Agreement to the contrary, you and Epson agree that if Epson makes any future amendments to the dispute resolution procedure and class action waiver provisions (other than a change to Epson's address) in this Agreement, Epson will obtain your affirmative assent to the applicable amendment. If you do not affirmatively assent to the applicable amendment, you are agreeing that you will arbitrate any Dispute between the parties in accordance with the language of this Section 1 (or resolve disputes as provided for in Section 1.7, if you timely elected to opt-out when you first assented to this Agreement).

**1.9 Severability.** If any provision in this Section 1 is found to be unenforceable, that provision shall be severed with the remainder of this Agreement remaining in full force and effect. **The foregoing shall not apply to the prohibition against class or representative actions as provided in Section 1.5. This means that if Section 1.5 is found to be unenforceable, the entire Section 1 (but only Section 1) shall be null and void.**

Parent topic: [Notices](#)

## Trademarks

EPSON® is a registered trademark, EPSON Exceed Your Vision is a registered logomark, and Epson Connect™ is a trademark of Seiko Epson Corporation.

Epson Store<sup>SM</sup> is a service mark of Epson America, Inc.

Epson iPrint™ and Remote Print™ are trademarks of Seiko Epson Corporation.

Apple, App Store, AirPrint, AirPrint logo, iPad, iPhone, iPod touch, Mac, and OS X are trademarks of Apple Inc., registered in the U.S. and other countries.

Google® is a registered trademark and Android™, Chromebook™, Gmail™, Google Chrome™, Google Cloud Print™, Google Drive™, and Google Play™ are trademarks of Google Inc.

Wi-Fi Direct® is a registered trademark of Wi-Fi Alliance®.

General Notice: Other product names used herein are for identification purposes only and may be trademarks of their respective owners. Epson disclaims any and all rights in those marks.



**Parent topic:** [Notices](#)

## Copyright Notice

All rights reserved. No part of this publication may be reproduced, stored in a retrieval system, or transmitted in any form or by any means, electronic, mechanical, photocopying, recording, or otherwise, without the prior written permission of Seiko Epson Corporation. The information contained herein is designed only for use with this Epson product. Epson is not responsible for any use of this information as applied to other products.

Neither Seiko Epson Corporation nor its affiliates shall be liable to the purchaser of this product or third parties for damages, losses, costs, or expenses incurred by purchaser or third parties as a result of: accident, misuse, or abuse of this product or unauthorized modifications, repairs, or alterations to this product, or (excluding the U.S.) failure to strictly comply with Seiko Epson Corporation's operating and maintenance instructions.

Seiko Epson Corporation shall not be liable for any damages or problems arising from the use of any options or any consumable products other than those designated as Original Epson Products or Epson Approved Products by Seiko Epson Corporation.

Seiko Epson Corporation shall not be held liable for any damage resulting from electromagnetic interference that occurs from the use of any interface cables other than those designated as Epson approved Products by Seiko Epson Corporation.

This information is subject to change without notice.

[A Note Concerning Responsible Use of Copyrighted Materials](#)

[Default Delay Times for Power Management for Epson Products](#)

[Copyright Attribution](#)

**Parent topic:** [Notices](#)

## **A Note Concerning Responsible Use of Copyrighted Materials**

Epson encourages each user to be responsible and respectful of the copyright laws when using any Epson product. While some countries' laws permit limited copying or reuse of copyrighted material in certain circumstances, those circumstances may not be as broad as some people assume. Contact your legal advisor for any questions regarding copyright law.

**Parent topic:** [Copyright Notice](#)

## **Default Delay Times for Power Management for Epson Products**

This product will enter sleep mode after a period of nonuse. This is to ensure that the product meets Energy Star standards of energy efficiency. More energy savings can be achieved by setting the time to sleep to a shorter interval.

**Parent topic:** [Copyright Notice](#)

## **Copyright Attribution**

© 2017 Epson America, Inc.

8/17

CPD-54003

**Parent topic:** [Copyright Notice](#)