

OWNER'S MANUAL

# nuwave Duet™

Pressure Cooker & Air Fryer Combo



[nuwavenow.com](http://nuwavenow.com)

# REGISTER NOW!

As a special thank-you for registering your NuWave unit, you'll automatically receive an additional 6 months added to your limited manufacturer's warranty!\*

All you have to do is follow these simple steps.

- 1** Using your smartphone or smart device, scan the QR code located on the unit label on the back of the unit.
- 2** You will be directed to NuWave's product registration page with your unit's unique serial number automatically entered in the appropriate field.  
**NOTE:** If you do not have a web-enabled smart device, simply visit [nuwavenow.com/QR](http://nuwavenow.com/QR) and manually enter in your unit's serial number.
- 3** Fill out the remaining information and complete the optional survey.
- 4** Once you submit your information, you will receive a confirmation email containing your extended warranty details.

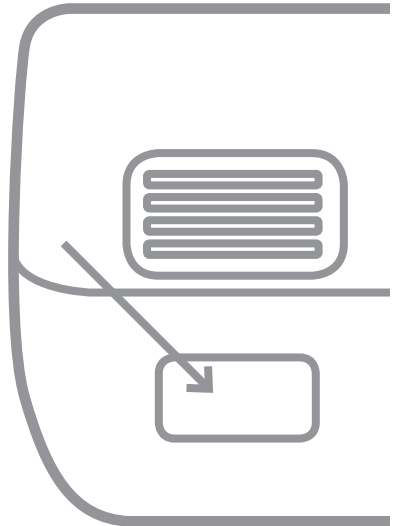

*\*Register your product within 1 year of date of purchase for a free 6-month extension of your limited warranty.*

for an additional  
**6 months  
warranty!**

## DOWNLOAD THE QR CODE APP TO YOUR MOBILE DEVICE

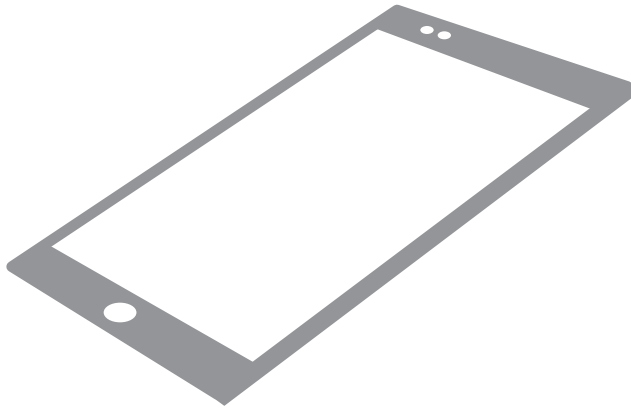

- 1** Open your mobile app store (App Store, Google Play).



- 2** Search for "QR code readers."



- 3** Simply download the QR code reader to your phone, open it, scan the code and you are ready to go.

**NOTE:** You may need to open your downloaded QR code reader each time you want to scan a QR code.

# TABLE OF CONTENTS

## OWNER'S MANUAL

Important Safeguards .....5-9

Parts & Accessories ..... 10-11

Quickstart.....12-13

Pressure Cooking Instructions .....14-23

Air Frying Instructions .....24-35

Combo Cooking Instructions .....36-37

**Cleaning & Maintenance** .....38-40

**Troubleshoot Guide**..... 41

**Limited Warranty** .....42-43

**Replaceable Parts**.....44-47



[nuwavenow.com](http://nuwavenow.com)

# IMPORTANT SAFEGUARDS

HOUSEHOLD USE ONLY • READ ALL INSTRUCTIONS BEFORE USE

ENGLISH

**Operate only in accordance with intended use as described in this manual. When using electrical appliances, basic safety precautions should always be followed including the following:**

1. Read all instructions.
2. Ensure the appliance and all parts are clean and dry before each use.
3. Do not touch hot surfaces. The appliance's surfaces may be hot during and after use. Use handles as directed to handle appliance.
4. A short power-supply cord is provided to reduce risk.
5. Do not let cord hang over any edge or let the cord touch hot surfaces.
6. Discard the protective plastic covering the power plug before use.
7. Do not immerse cord, plugs, or appliance in water or other liquid.
8. Close supervision is necessary when any appliance is used near children. This appliance is not intended for use by persons with reduced physical, sensory or mental capabilities, children, or persons with lack of experience or knowledge, unless supervised or instructed on the use of the appliance by one responsible for their safety.
9. Unplug from outlet when not in use and before cleaning. Allow to cool before removing or replacing parts.
10. Do not operate if the appliance or the appliance's cord malfunctions or has been damaged in any way. Return appliance to the nearest authorized service facility for examination, repair, or adjustment.
11. Use only on a clean, stable, dry and level surface.
12. Do not use accessories or attachments not recommended by the manufacturer.
13. Do not use outdoors. This appliance is intended for non-commercial, indoor use only.
14. Do not place on or near a hot surface or in a heated oven.
15. Use caution when moving an appliance after cooking. NEVER move the appliance while it is operating and/or under pressure.
16. Unplug the appliance when not in use and allow the appliance to cool completely before cleaning or removing/replacing parts.

## **ADDITIONAL SAFEGUARDS**

### **SEE CLEANING & MAINTENANCE BEFORE USE**

---

#### **Save These Instructions**

**This appliance has a polarized plug (one blade is wider than the other). To reduce the risk of electric shock, this plug is intended to fit into a polarized outlet only one way. If the plug does not fit fully into the outlet, reverse the plug. If it still does not fit, contact a qualified electrician. Do not attempt to modify the plug in any way.**

1. DO NOT use the appliance without supplied Stainless Steel Inner Pot installed.
2. This unit cooks under pressure and releases hot steam. READ ALL instructions for proper use of this appliance to avoid injury.
3. DO NOT cover the Pressure Release Switch/Valve or Pressure Indicator. Before each use, ALWAYS check the Pressure Release Switch/Valve and the Pressure Indicator for blockage or obstructions. These should move freely and should not be stuck in one position. Foods that expand (pasta, rice, grains, beans, oatmeal, etc.) may block these so clean thoroughly after each use.
4. Use caution when removing the Stainless Steel Inner Pot from the unit, as the pot may be heavy and hot. Use protective gloves or hot pads.
5. DO NOT place food or liquids directly into the appliance without the Stainless Steel Inner Pot.
6. DO NOT use Silicone Gasket if they are torn or damaged. Clean after each use. ONLY NuWave LLC Silicone Gasket is to be used in the operation of this unit.
7. DO NOT sear foods under pressure. The pressure-cooking Sear function is intended to be used without the Pressure Cooker Lid.
8. NEVER use the Slow Cook or Warm functions without food or liquid in the Stainless Steel Inner Pot.
9. This appliance is not intended for deep-frying.
10. DO NOT overfill the Stainless Steel Inner Pot. NEVER fill more than  $\frac{3}{4}$  full. For starchy foods or foods that will expand (pasta, rice, grains, beans, oatmeal, etc.), NEVER fill the Stainless Steel Inner Pot more than  $\frac{3}{4}$  full.

11. NEVER pressure cook without liquid. The amount of liquid needed is provided in the recipes.
12. NEVER attempt to open the Pressure Cooker Lid while the appliance is in use or pressure. DO NOT force the Lid to open at any time. Ensure ALL pressure is released BEFORE opening the Pressure Cooker Lid by turning the Pressure Release Switch/Valve to the “OPEN” position.
13. Keep all body parts away from the appliance when the appliance is releasing pressure. DO NOT place any body part over the Pressure Release Switch/Valve or anywhere steam may escape. When opening the Lid (ONLY after all pressure has been released and the Pressure Indicator has dropped), the contents of the appliance will still be hot and opening the Lid will release steam. Make sure to open the Pressure Cooker Lid away from yourself and others.
14. If any part of the appliance is missing or damaged DO NOT use the appliance. Contact NuWave LLC Customer Service for replacement parts: **1-877-689-2838** or **help@nuwavenow.com**.

	 <b>WARNING</b>
	<p><b>In case of other problems, immediately unplug and contact Customer Service Department.</b></p> <p><b>1-877-689-2838 • help@nuwavenow.com</b></p>

# IMPORTANT SAFEGUARDS

HOUSEHOLD USE ONLY • READ ALL INSTRUCTIONS BEFORE USE

---

1. Do not use accessories or attachments not recommended by the manufacturer.
2. DO NOT overfill the Air Fry Basket.
3. DO NOT cover the air intake or outlet vents. This may prevent the appliance from performing correctly and may damage the unit.
4. It is not unusual for a small amount of steam and/or smoke to occasionally be released from the air outlet vent. Keep hands and face away from the air outlet vents to avoid injury.
5. When removing the Air Fryer Lid, after use the heating elements are contained inside the Lid and may be extremely hot. Place Air Fryer Lid on the Air Fryer Lid Holder to avoid damage to property. Refer to Cleaning & Maintenance for instructions.
6. The Air Fry Basket and any accessories used may be extremely hot during and immediately after use. ALWAYS use oven mitts or hot pads when handling these items.
7. This appliance is not intended for deep-frying.
8. Ensure the appliance and all parts are clean and dry before each use.
9. Unplug the appliance when not in use and ensure it is completely cool before cleaning.
10. If any part of the appliance is missing or damaged DO NOT use the appliance. For replacement parts contact NuWave LLC Customer Service for replacement parts: 1-877-689-2838 or [help@nuwavenow.com](mailto:help@nuwavenow.com).

## SAVE THESE INSTRUCTIONS

Read and understand the entire manual before using the Duet. This appliance has a polarized plug (one blade is wider than the other). To reduce the risk of electric shock, this plug is intended to fit into a polarized outlet only one way. If the plug does not fit fully into the outlet, reverse the plug. If it still does not fit, contact a qualified electrician.

**Do not attempt to modify the plug in any way.**

- A.** A short power-supply cord (or detachable power-supply cord) is provided to reduce the risk resulting from becoming entangled in or tripping over a longer cord.
- B.** Longer detachable power-supply cords or extension cords are available and may be used if care is exercised in their use.
- C.** If a longer detachable power-supply cord or extension cord is used:
  - 1. The marked electrical rating of the cord set or extension cord should be at least as great as the electrical rating of the appliance;
  - 2. The cord should be arranged so that it will not drape over the surface where it can be pulled on by children or tripped over unintentionally; and
  - 3. If the appliance is of the grounded type, the cord set or extension cord should be a grounding-type 3-wire cord.

# PARTS & ACCESSORIES

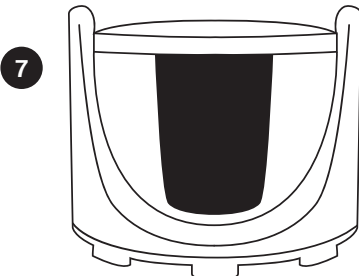
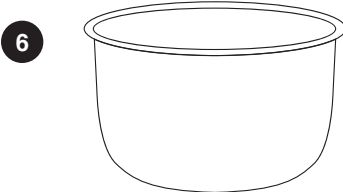
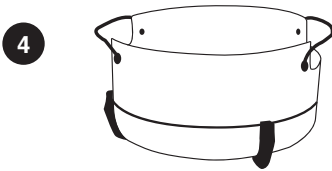
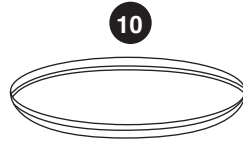
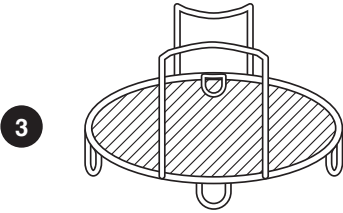
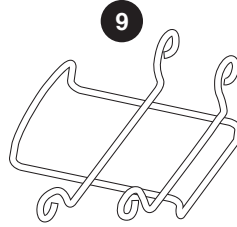
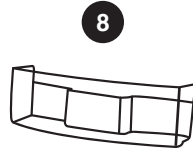
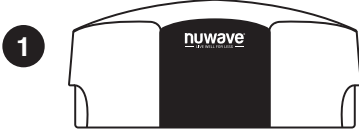

To order replaceable parts head over to Replaceable Parts section and then [NuWaveNow.com](http://NuWaveNow.com).

- 1 Air Fryer Lid**  
Part #: 34805
- 2 Pressure Cooker Lid**  
Part #: 34802
- 3 Stainless Steel Reversible Rack**  
Part #: 34808
- 4 Non-Stick Air Fry Basket**  
Part #: 34806
- 5 Air Fry Basket Diffuser**  
Part #: 34807
- 6 Stainless Steel Inner Pot**  
Part #: 34803
- 7 Duet™ Base**  
Part #: 34801 (Gray)  
Part #: 34816 (Red)
- 8 Water-Collection Tray**  
Part #: 34804
- 9 Air Fryer Lid Holder**  
Part #: 34815
- 10 Silicone Gasket**  
Part #: 34813

# QUICKSTART

---

**PRESSURE COOK:** Use the PRESSURE COOK button to initiate the pressure cooker function.

**Note:** Sometimes the cooking process can create a seal between the Pressure Cooker Lid and the Stainless Steel Inner Pot. To prevent lifting the pot along with the Lid, gently shake the handle to separate the Lid from the pot before opening.

**COMBO COOK:** Use the COMBO COOK button to initiate the combo cooking function.

**AIR FRY:** Use the AIR FRY button to initiate the air fryer function.

**START/PAUSE:** When the START/PAUSE button is pressed, the Duet begins or pauses cooking. The START/PAUSE dial is turned to adjust cooking functions and (TEMP & TIME) and to scroll through Menu options.

Mute the beep sounds on the Duet by pressing and holding the START/PAUSE button for 3 seconds. To unmute, press and hold the START/PAUSE button for 3 seconds.

**Note:** Pause is disabled during pressure cooking.

**TEMP:** Use the TEMP button to show the cooking temperature. Use the START/PAUSE dial to adjust the temperature before or during cooking.

**TIME:** Use the TIME button to show the cooking time. Use the START/PAUSE dial to adjust the time before or during cooking.

**PRESSURE:** Press the PRESSURE button to switch between HIGH pressure and LOW pressure setting.

**Note:** The PRESSURE button is disabled during air-frying.

**CANCEL:** The CANCEL button is used to clear out any functions that are set into the Duet at any time.

**DELAY:** Use the DELAY button to delay cooking for up to 24 hours. Use the START/PAUSE dial to adjust the delay time.

**PREHEAT:** Use the PREHEAT button to heat the Duet to correct temperature before adding food. To cancel the preheat function, press the PREHEAT button at any time.

**Note:** The PREHEAT button is disabled during pressure cooking.

**SEAR:** The SEAR button is used to cook at high temperature for a short amount of time.

**STAGE:** The STAGE button is used to scroll through cooking functions during PRESSURE COOK. During AIR FRY, use the STAGE button to set up to 5 different cooking stages. Cooking temperatures and times can be adjusted for each stage of cooking using the TEMP and TIME buttons and the START/PAUSE dial.

**WARM:** Use the WARM button to keep your food warm after cooking or when keeping warm for an extended amount of time. Use the START/PAUSE dial to adjust the warming temperature and warming time. Press the WARM button to cancel the warm cycle.

**PROGRAM:** The Duet comes with 300 preprogrammed cooking recipes along with an additional 240 memory slots to add your own unique recipes the way you like them cooked. Use the PROGRAM button to recall and save programmed recipes.

**Note:** The Duet will go into standby mode after 5 minutes of no interaction with the control panel. Simply press any button or turn the START/PAUSE dial to “wake up.”

SEAR, PRESSURE, DELAY, WARM, TEMP, PROG, TIME and STAGE buttons are available for use when pressure cooking.

# PRESSURE COOKING INSTRUCTIONS

---

## PRESSURE COOK

1. Plug the power cord into an electrical outlet. The Duet will power on and the display will show --:--.
2. Press the PRESSURE COOK button.
  - The lights on the SEAR, PRESSURE, DELAY, WARM, TEMP, PROG, TIME and STAGE buttons will light up for 1-2 seconds then go out indicating those functions are available for use.
  - The display will show pressure cook and --:--.

**Note:** The PREHEAT button is disabled during use of the Pressure Cook function.

## START/PAUSE

**Note:** The Pause Function is Disabled During Pressure Cooking.

1. Ensure the Stainless Steel Inner Pot is in the Duet. If the Pot is not detected inside the Duet and START/PAUSE is pressed, you will receive an error message that reads “Pot” on the display. Also make sure the Pressure Cooker Lid is on and locked into place. The “Lock” symbol will show on the display when the Lid is in place.
2. Press the TIME button. The display will show pressure cook, high, and 00:30. High and 00:30 (30 minutes) are the default settings. These functions can be adjusted at this time (please see the PRESSURE and TIME functions for more details).
3. Press the START/PAUSE button to begin cooking.
  - The display will show pressure cook, high, and PH. The PH indicates that the Duet is preheating/pressurizing.
  - Once the Duet gets to correct pressure, the unit will beep once and begin cooking. The display will show pressure cook, high, 00:30 (default time), and time. The “.” will flash, indicating the Duet is currently cooking and 30 minutes remain.
4. Once the Duet finishes cooking, the display will show End and the unit will beep 3 times.

5. To natural release pressure, turn the Duet off and unplug. Allow the Duet to naturally release the pressure. To quick release pressure, carefully turn the Pressure Release Switch/Valve to the “OPEN” position until all steam/pressure is released. **Remember to always turn the Pressure Release Switch/Valve to the “OPEN” position before opening the Pressure Cooker Lid to ensure all pressure is released.**

**Note:** Be very careful when releasing pressure from the pressure cooker. A jet of hot steam will release from the Pressure Release Switch/Valve and could burn you if care is not taken.

### **Using START/PAUSE to Mute and Unmute Sound**

1. Press and hold the START/PAUSE button for 3 seconds to mute the beep sounds the Duet makes.
2. Simply press and hold the START/PAUSE button for 3 seconds again to unmute the beep sounds.

### **Quick Start**

1. Plug the power cord into an electrical outlet. The Duet will power on and the display will show --:--.
2. Press the PRESSURE COOK button. The lights on the SEAR, PRESSURE, DELAY, WARM, TEMP, PROG, TIME and STAGE buttons will light up for 1-2 seconds then go out, indicating those functions are available for use.
3. Press the TIME button. The display will show pressure cook, high, and 00:30.
4. Turn the START/PAUSE dial to adjust the cooking time.
5. Press the PRESSURE button to adjust between high pressure or low pressure (please see PRESSURE functions of this instruction manual for more details).
6. Press the START/PAUSE button to begin cooking. The Duet will first pressurize to high or low pressure depending on what you set, then it will cook to the time set.
7. When done, the Duet will beep 3 times and the display will show End.

# PRESSURE COOKING INSTRUCTIONS

---

## TIME

1. Press the PRESSURE COOK button. The lights on the SEAR, PRESSURE, DELAY, WARM, TEMP, PROG, TIME and STAGE buttons will light up for 1-2 seconds then go out, indicating those functions are available for use.
2. Press the TIME button to adjust the amount of time you would like your meal to cook under pressure. Depending on the pressure set, the Duet can be set up to 24 hours under low pressure and 10 hours under high pressure.
3. The time can be adjusted up or down by turning the START/PAUSE dial clock wise or counterclockwise.
4. Press the START/PAUSE button to begin cooking.
5. When done, the Duet will beep 3 times and the display will show End.
6. To natural release pressure, turn the Duet off and unplug. Allow the Duet to naturally release the pressure. To quick release pressure, carefully turn the Pressure Release Switch/Valve to the "OPEN" position until all steam/pressure is released. **Remember to always turn the Pressure Release Switch/Valve to the "OPEN" position before opening the Pressure Cooker Lid to ensure all pressure is released.**

## PRESSURE

Press the PRESSURE button to switch between HIGH pressure and LOW pressure settings.

1. Press the PRESSURE COOK button. The lights on the SEAR, PRESSURE, DELAY, WARM, TEMP, PROG, TIME, and STAGE buttons will light up for 1-2 seconds then go out, indicating those functions are available for use.
2. Press the PRESSURE button to change the Duet from HIGH pressure to LOW pressure. The display will show low. The Duet will now cook under LOW pressure.
3. Press the PRESSURE button again to change back to HIGH pressure.
4. Use the START/PAUSE dial to adjust the cooking time.
5. Press the START/PAUSE button to begin the cooking process.

## SEAR

1. Press the PRESSURE COOK button. The lights on the SEAR, PRESSURE, DELAY, WARM, TEMP, PROG, TIME, and STAGE buttons will light up for 1-2 seconds then go out, indicating those functions are available for use.
2. Press the SEAR button heat the bottom of the pressure cooker pot to sear meats, fish, and vegetables before pressure cooking.
3. The display will show pressure cook, sear, time, and 00:20 (20 minutes).
4. Turn the START/PAUSE dial to adjust the sear time, up to 00:30 (30 minutes).
5. Press the TEMP button to adjust the sear temperature. The display will show pressure cook, sear, temp, and 275F.
6. Turn the START/PAUSE dial to adjust sear temperature between 60°F and 275°F.
7. Press the START/PAUSE button to begin searing. The Duet will sear for set the time.
  - Both temperature and time can be adjusted with the START/PAUSE dial and the TEMP and TIME buttons during searing.
  - This can be used to increase time if you feel you need a few more minutes to finish searing your foods or to increase or decrease the searing temperature.
8. When finished the display will show End.

**Note:** The Sear function should not be used with the Pressure Cooker Lid on and locked into place.

## DELAY

1. Press the PRESSURE COOK button. The lights on the SEAR, PRESSURE, DELAY, WARM, TEMP, PROG, TIME, and STAGE buttons will light up for 1-2 seconds then go out indicating those functions are available for use.
2. Set cooking functions, as described in this manual, to your specifications.
3. Press the DELAY button delay cooking for designated time period up to 24:00 (24 hours). The display will show pressure cook, delay, time, and 01:00 (1 hour).

## PRESSURE COOKING INSTRUCTIONS

---

4. Turn the START/PAUSE dial to adjust the delay time up to 24:00 (24 hours).
5. Press the START/PAUSE button to begin the delay time countdown. During the delay time countdown, the “.” will flash, indicating the countdown has begun.
6. Delay time can be added or reduced at any time by turning the START/PAUSE dial.
7. Once the delay time countdown has ended, the Duet will automatically begin to pressurize and go into cooking cycle.
8. To cancel the Delay function, press the DELAY button. The Duet will move into the next phase of cooking.
9. After the delay time has elapsed, the Duet will automatically move into the next phase of cooking.
10. Once the Duet finishes cooking, the display will show End and the unit will beep 3 times.
11. To do a quick release of the steam and pressure, carefully turn the Pressure Release Switch/Valve to the Open position.
12. To natural release pressure, turn the Duet off and unplug. Allow the Duet to naturally release the pressure. To quick release pressure, carefully turn the Pressure Release Switch/Valve to the “OPEN” position until all steam/pressure is released. **Remember to always turn the Pressure Release Switch/Valve to the “OPEN” position before opening the Pressure Cooker Lid to ensure all pressure is released.**

### WARM

1. Press the PRESSURE COOK button. The lights on the SEAR, PRESSURE, DELAY, WARM, TEMP, PROG, TIME, and STAGE buttons will light up for 1-2 seconds then go out, indicating those functions are available for use.
2. Set cooking functions, as described in this manual, to your specifications.
3. Press the WARM button to engage the warm function and keep your food warm after cooking until you're ready to serve.
4. The display will show pressure cook, time, warm, and 01:00 (1 hour).

5. Turn the START/PAUSE dial to adjust the warming time, up to 24:00 (24 hours).
6. Press the START/PAUSE button to begin cooking.
7. To cancel the warm function at any time, press the WARM button.
8. To adjust the warming time during cooking, press the WARM button until warm and the set warm time appear in the display.
9. Use the START/PAUSE dial to make any adjustments to the warming time.
10. Press the TIME button to see how much cooking time remains.
11. When the Duet finishes cooking it will automatically go into Warm function.
12. Once the Warm function time ends, the display will show End and the unit will beep 3 times.
13. To natural release pressure, turn the Duet off and unplug. Allow the Duet to naturally release the pressure. To quick release pressure, carefully turn the Pressure Release Switch/Valve to the “OPEN” position until all steam/pressure is released. **Remember to always turn the Pressure Release Switch/Valve to the “OPEN” position before opening the Pressure Cooker Lid to ensure all pressure is released.**

### **Warm Used as an Independent Function**

Warm can be used as its own function to keep food items warm.

1. Press the PRESSURE COOK button. The lights on the SEAR, PRESSURE, DELAY, WARM, TEMP, PROG, TIME, and STAGE buttons will light up for 1-2 seconds then go out, indicating those functions are available for use.
2. Press and hold the WARM button for 2 seconds. The Duet will automatically begin to warm.
3. The display will show pressure cook, time, warm, and 01:00 (1 hour).
4. Turn the START/PAUSE dial to adjust the warm time up to 24:00 (24 hours).
5. Once the warm function time ends, the display will show End and the unit will beep 3 times.

# PRESSURE COOKING INSTRUCTIONS

---

## PROG

The PROG button represents Program Memory Entry (the storage of frequently used cooking sequences) and Program Memory Recall (retrieval of cooking sequences).

### Memory Recall

1. Press the PRESSURE COOK button. The lights on the SEAR, PRESSURE, DELAY, WARM, TEMP, PROG, TIME, and STAGE buttons will light up for 1-2 seconds then go out, indicating those functions are available for use.
2. Press the PROG button to recall a program from the Duet's Memory. The display will show pressure cook, prog, and 1. The "1" indicates program number 1.
3. Turn the START/PAUSE dial to the right (clockwise) to count up in program number and turn it to the left (counterclockwise) to count down in program number.
4. Once the number of the program that you want to use shows in the display, press the START/PAUSE button.
5. The display will show the default time setting for that program as well as the default pressure setting.

**Note:** These are both adjustable using the PRESSURE button to adjust pressure setting, and the TIME button and START/PAUSE dial to adjust time setting.

6. Press the START/PAUSE button to begin the cooking process.
7. Once the Duet finishes cooking, the display will show End and the unit will beep 3 times.
8. To natural release pressure, turn the Duet off and unplug. Allow the Duet to naturally release the pressure. To quick release pressure, carefully turn the Pressure Release Switch/Valve to the "OPEN" position until all steam/pressure is released. **Remember to always turn the Pressure Release Switch/Valve to the "OPEN" position before opening the Pressure Cooker Lid to ensure all pressure is released.**
9. There are 100 preset programs already programmed into the Duet (#1-100). There are an additional 80 memory slots for you to save your own unique recipes (#101-180).

**To Program Your Own Unique Recipe Before Cooking**

1. Press the PRESSURE COOK button. The lights on the SEAR, PRESSURE, DELAY, WARM, TEMP, PROG, TIME, and STAGE buttons will light up for 1-2 seconds then go out, indicating those functions are available for use.
2. Set your cooking parameters using SEAR, PRESSURE, DELAY, TIME, and WARM.
3. Once the cooking parameters are programmed into the Duet, press the PROG button. The display will show prog and 101.
4. Use the START/PAUSE dial to scroll through the program memory slot numbers until you reach the number you would like to save the program to (101-180).
5. Once the desired program number is reached, press the PROG button a second time. The Duet will beep once and the program is saved into the memory for future recall.

**To Program Your Own Unique Recipe After Cooking**

1. Press the PRESSURE COOK button. The lights on the SEAR, PRESSURE, DELAY, WARM, TEMP, PROG, TIME, and STAGE buttons will light up for 1-2 seconds then go out, indicating those functions are available for use.
2. Set your cooking functions using SEAR, PRESSURE, DELAY, and WARM.
3. Once programmed into the Duet, press the START/PAUSE button. The Duet will begin the cooking process.
4. When done the unit will beep 3 times and the display will show End.
5. Press the PROG button. The display will show prog and 101.
6. Use the START/PAUSE dial to scroll through the program memory slot numbers until you reach the number you would like to save the program to (101-180).
7. Once the desired program number is reached, press the PROG button a second time. The Duet will beep once and the program is saved into the memory and can be recalled later.

# PRESSURE COOKING INSTRUCTIONS

---

## View Current Program During Cooking

1. During cooking, press and hold down the PROG button. The display will show the program number currently running.
2. Release the PROG button to see the previous screen on the display.

## Editing a Program

You can edit the programs you create (101-180) before or during the cooking process and save any changes.

1. Edit Before Cooking:
  - Press the PROG button and use the START/PAUSE dial to find the program number to edit.
  - Once the program number shows in the display, press the STAGE button until you reach the function you want to edit. Use the START/PAUSE dial to adjust temperatures and times.
  - To add a function, press the function of choice and use the START/PAUSE dial to make your adjustments.
  - Once all edits are made, press the PROG button. The display will show prog and 101.
  - Use the START/PAUSE dial to find the program number to save your edits to.
  - Press the PROG button again to save and store the edits for later recall.
2. Edit During Cooking:
  - During cooking press the STAGE button until you reach the function you want to edit. Use the START/PAUSE dial to adjust.
  - To add a function, press the function of choice and use the START/PAUSE dial to make your adjustments.
  - The unit will continue the cooking process with the edits that you have made.

**Note:** Functions that have already ended in the cooking cycle cannot be edited or added during cooking.

- When cooking has finished, the unit will beep 3 times and the display will show End followed by SAVE.
- Press the PROG button. The display will show prog and 101.
- Use the START/PAUSE dial to find the program number to save your edits to.
- Press the PROG button again to save and store the edits for later recall.

**Note:** If any recipe is saved into a program (memory slot) that is already filled, the new recipe with set temperatures and times will override the previous program recipe (101-180 only). Preset temperatures and times for program recipes 1-100 can be adjusted. Adjusted temps and times will not be saved when a program number (1-100) is recalled once again.

### **CANCEL**

Press the CANCEL button at any time to cancel and end all operation of the Duet. Once CANCEL is pressed the display will show --:--, this is standby mode.

# AIR FRYING INSTRUCTIONS

---

## AIR FRY

SEAR, DELAY, WARM, TEMP, PROG, TIME, PREHEAT, and STAGE buttons are available for use when air-frying.

1. Plug the power cord into an electrical outlet. The Duet will power on and the display will show --:--.
2. Press the AIR FRY button.
  - The lights on the SEAR, DELAY, WARM, TEMP, PROG, TIME, PREHEAT, and STAGE buttons will light up for 2 seconds indicating those functions are available for use.
  - The display will show air fry, temp, and 360F. If the Lid is removed, open will also show in the display. Place the Lid on the Duet and open will no longer be lit.

**Note:** The PRESSURE button is disabled during use of the air fryer.

## START/PAUSE

1. Ensure the Air Fryer Lid is on the Duet and press the START/PAUSE button to begin cooking.
  - The display will show air fry, time, and 00:15 (15 minutes).
  - The “:” will flash, indicating the Duet is currently cooking.
  - Turn the START/PAUSE dial to adjust the cooking time, if desired.
  - Press the TEMP button to adjust the cooking temperature, if desired.
  - Turn the START/PAUSE button to adjust the cooking temperature.
2. To pause cooking, press the START/PAUSE button or remove the Air Fryer Lid.
  - The “:” will no longer flash. This indicates the Duet is paused.
  - If the Air Fryer Lid is removed to pause cooking, the display will show air fry, Lid, and open.
3. To resume cooking, simply return the Air Fryer Lid and the “:” will begin to flash, indicating the Duet has resumed cooking.
4. Once the Duet finishes cooking, the display will show End and the unit will beep 3 times.

**TEMP**

1. Press the TEMP button at any time you want to see or adjust the cooking temperature.
2. The temperature can be adjusted higher or lower by turning the START/PAUSE dial clockwise or counterclockwise.
3. Temperature can be adjusted during cooking by pressing the TEMP button and turning the START/PAUSE dial to adjust.

**TIME**

1. Press the TIME button at any time to see or adjust the cooking time.
2. The time can be adjusted up or down by turning the START/PAUSE dial, clockwise or counterclockwise.
3. Press the START/PAUSE button to begin cooking.
4. Time can be adjusted during cooking by pressing the TIME button and turning the START/PAUSE dial to adjust.

**Selectable Temperature and Time Ranges:**

60F~200F: 00:00-99:99 (0 min. to 99 hours; 99 minutes)

280F~345F: 00:00-10:00 (0 min. to 10 hrs.)

350F~400F: 00:00-01:00 (0 min. to 1 hr.)

**DELAY**

Delay can be used with the Air Fry function.

1. Press the AIR FRY button.
  - The lights on the SEAR, DELAY, WARM, TEMP, PROG, TIME, PREHEAT, and STAGE buttons will light up for 2 seconds, indicating those functions are available for use.
  - The display will show air fry, temp, and 360F. If the Lid is removed, open will also show in the display. Place the Lid on the Duet and open will no longer be lit.
2. Set cooking functions, as described in this manual, to your specifications.
3. Press the DELAY button to delay cooking for designated time period, up to 24:00 (24 hours). The display will show air fry, delay, time, and 01:00 (1 hour).

## AIR FRYING INSTRUCTIONS

---

4. Turn the START/PAUSE dial to adjust the delay time up to 24:00 (24-hours).
5. Press the START/PAUSE button to begin the delay time countdown. During the Delay time countdown, the “:” will flash, indicating the countdown has begun.
6. Delay time can be added or reduced at any time by turning the START/PAUSE dial.
7. Once the delay time countdown has ended, the Duet will automatically go into the cooking cycle.
8. To cancel the Delay function, press the DELAY button. If operating, the Duet will move into the next phase of cooking.

### STAGE

Stage cooking is used to cook foods at different temperatures and times throughout the cooking process. Up to 5 stages of cooking can be set up. DELAY, PREHEAT, SEAR 1, SEAR 2, AND WARM are NOT considered stages. Stage 1 cooking is the default (360F for 15 minutes).

1. Plug the power cord into an electrical outlet. The Duet will power on and the display will show --:--.
2. Press the AIR FRY button.
  - The lights on the SEAR, DELAY, WARM, TEMP, PROG, TIME, PREHEAT, and STAGE buttons will light up for 2 seconds, indicating those functions are available for use. The display will show air fry, temp, and 360F. This is Stage 1.
3. Adjust the cooking temperature by turning the START/PAUSE dial until the desired cooking temperature is reached.
4. Press the TIME button and use the START/PAUSE dial to adjust Stage 1 cooking time.
5. To add an additional stage, press the STAGE button once. The display will show stage, and 2 (above stage). This is Stage 2 cooking.
6. Adjust Stage 2 cooking temperature by turning the START/PAUSE dial until the desired cooking temperature is reached.

7. Press the TIME button. The display will show 00:00, time, stage and 2 (above stage). Use the START/PAUSE dial to adjust Stage 2 cooking time.
8. To set additional stage cooking settings, repeat steps 5-7.
  - The number above stage will change after you press the STAGE button and set temperature and time.
  - After Stage 5, when the STAGE button is pressed again the unit will go back to Stage 1. The display will show Stage 1 set cooking temperature, temp, stage, and 1 (above stage).
9. If you only want 2 stages of cooking, leave the time at 00:00 for stages 3-5 and those stages will be skipped.
10. Press the START/PAUSE button to begin cooking. The unit will cook with the set functions.
11. During cooking, press the STAGE button to see and adjust upcoming cooking stages and cooking functions (sear 1 & 2, preheat, and warm).
12. When finished cooking the display will show End and the unit will beep 3 times.

**Notes:**

- The display will only indicate the stage cooking number when 2 or more stages are used.
- The display will not show stage cooking if only one stage of cooking is used.
- Stage 1 default: 360F, 00:15
- Stage 2-5 default: 360F, 00:00
- If no time is set for stages 2-5, those stages will be skipped in the cooking cycle.

**PREHEAT**

When air-frying use the Air Fryer Lid.

1. Press the AIR FRY button.
  - The lights on the SEAR, DELAY, WARM, TEMP, PROG, TIME, PREHEAT, and STAGE buttons will light up for 2 seconds, indicating those functions are available for use.
  - The display will show air fry, temp, and 360F. If the Lid is removed, open will also show in the display. Place the Lid on the Duet and open will no longer be lit.

## AIR FRYING INSTRUCTIONS

---

2. Set cooking functions, as described in this manual, to your specifications.
3. Press the PREHEAT button to engage the preheat function. The display will show air fry, set cooking temperature, pre, and temp.
  - The Duet will ALWAYS preheat to the cooking temperature of the NEXT cooking cycle.
4. Press the START/PAUSE button to begin preheating. The Duet will begin preheating to the set temperature.
  - The display will show air fry, set cooking/preheat temperature (flashing), pre, and temp.
  - During preheat the temperature can be adjusted by turning the START/PAUSE dial.
  - The cooking time can also be adjusted by pressing the TIME button then adjusting by turning the START/PAUSE dial.
5. When the Duet reaches the preheat temperature it will go into a 5-minute hold. The unit will maintain the preheat temperature during this 5-minute hold.
  - During the 5-minute hold the display will show 5 (flashing), ready, and temp, and the unit will beep 3 times.
  - Cooking temperature can be adjusted by turning the START/PAUSE dial during the 5-minute hold.
  - The cooking time can also be adjusted by pressing the TIME button then adjusting by turning the START/PAUSE dial.
  - If no action is taken within the 5-minute hold, the Duet will automatically go into standby mode.
6. Remove the Air Fryer Lid and place your food into the unit. Replace the Air Fryer Lid. The Duet will begin cooking at the set temperature and time.
7. The preheat cycle can be canceled at any time by pressing the PREHEAT button. The unit will end the preheat cycle and automatically go into the next cooking cycle.
8. When the unit is finished cooking the display will show End and the unit will beep 3 times.

## SEAR

Sear 1 will always be directly BEFORE regular stage cooking and Sear 2 will always be directly AFTER regular stage cooking.

### Sear 1

Default sear 1 temperature is 400°F and default sear 1 time is 5 minutes (00:05).

1. Adjust your cooking temperatures and times for stage cooking.
2. Press the SEAR button one (1) time. This will engage the Sear 1 function. The display will show air fry, 400F, sear, 1 (flashing), and temp.
  - Sear 1 searing temperature can be adjusted by turning the START/PAUSE dial. 400°F is the maximum searing temperature.
  - Press the TIME button and use the START/PAUSE dial to adjust the sear 1 searing time up to 5 minutes (00:05).
3. Press the START/PAUSE button to begin cooking. The display will show sear 1 (flashing), time, and the set sear time (00:05 default) with the “.” flashing.
4. Once the Sear 1 cycle is complete the unit will automatically go into stage (regular) cooking.
5. When the unit is finished cooking the display will show End and the unit will beep 3 times.

### Sear 1 & 2

Sear 1 & 2 is used to sear before and after regular stage cooking.

1. Adjust your cooking temperatures and times for stage cooking.
2. Press the SEAR button one time and set your sear 1 temperature and time. Default is 400°F for 5 minutes. Press the SEAR button again. The display will show 400F, sear, 1, 2 (flashing), and temp.
3. Adjust the sear 2 temperature and time. Default is 400F for 5 minutes.
4. Press the START/PAUSE button to begin cooking. The display will show sear 1 (flashing), 2, time, and the set sear 1 time with the “.” flashing.

## AIR FRYING INSTRUCTIONS

---

5. Once the Sear 1 cycle is complete the unit will beep once and will automatically go into regular stage cooking. The display will show sear 2, time, and the set regular stage cooking time (00:15 default) with the “:” flashing.
6. Once the stage cooking cycle is complete the unit will beep once and will automatically go into sear 2 cooking. The display will show sear 2 (flashing), time, and the set sear time (00:05 default) with the “:” flashing.
7. When the unit is finished cooking the display will show End and the unit will beep 3 times.

### Sear 2

Default Sear 2 temperature is 400°F and default sear 2 time is 5 minutes (00:05).

1. Adjust your cooking temperatures and times for stage cooking.
2. Press the SEAR button 3 times. This will engage the Sear 2 function.
3. The display will show 400F, sear, 2 (flashing), and temp.
  - Sear 2 searing temperature can be adjusted by turning the START/PAUSE dial. 400°F is the maximum searing temperature.
  - Press the TIME button and turn the START/PAUSE dial to adjust the sear 2 searing time up to 5 minutes (00:05).
4. Press the START/PAUSE button to begin cooking. The display will show sear 2 , time, and the set regular stage cooking time (00:15 default) with the “:” flashing.
5. Once the stage cooking cycle is complete the unit will automatically go into sear 2 cooking. The display will show sear 2 (flashing), time, and the set sear time (00:05 default) with the “:” flashing.
6. When the unit is finished cooking the display will show End.
7. Press the SEAR button 4 times until sear, 1, and 2 are no longer lit in the display, to clear the Sear function.

### WARM

1. Set cooking functions, as described in this manual, to your specifications.

2. Press the WARM button to engage the warm function and keep your food warm after cooking until you're ready to serve.
3. The display will show air fry, temp, warm, and 145F.
4. Turn the START/PAUSE dial to adjust the warm temperature up to 200°F.
5. Press the TIME button to adjust the warming time.
6. The display will show air fry, warm, time, and 01:00 (1 hour).
7. Use the START/PAUSE dial to adjust Warm time up to 3 hours (03:00).
8. Press the START/PAUSE button to begin cooking.
9. To cancel the Warm function at any time, simply press the WARM button.
10. To adjust the Warm setting during cooking, press the STAGE button until warm and the set warm temperature appear in the display.
11. To adjust the warm time during cooking, press TIME and use the START/PAUSE dial to adjust.
12. To see the current running function, press the STAGE button until that function is flashing in the display.
13. When the Duet finishes cooking it will automatically go into Warm function.
14. When the Warm function ends, the Duet will beep 3 times and the display will show End.

**Warm Used as an Independent Function:** Warm can be used independently as its own function to keep food items warm.

1. Press and hold the WARM button for 2 seconds. The Duet will automatically begin to warm.
2. The display will show air fry, temp, warm, and 145F.
3. Turn the START/PAUSE dial to adjust the warm temperature up to 200°F.
4. Press the TIME button to adjust the warming time.

## AIR FRYING INSTRUCTIONS

---

5. The display will show air fry, warm, time, and 01:00 (1-hour).
6. Use the START/PAUSE dial to adjust warm time up to 3 hours (03:00).
7. Once the warm function time ends, the display will show End with three beep sounds.

**PROG:** The PROG button represents Program Memory Entry (the storage of frequently used cooking sequences) and Program Memory Recall (retrieval of cooking sequences).

**Memory Recall:** Press the PROG button. The display will show air fry, prog and, 1.

1. Use the START/PAUSE dial to choose the desired program number to recall.
  - Numbers 1-100 are preset programs.
  - Numbers 101-180 are your unique programs.
2. Once the program number is chosen, press the START/PAUSE button to begin cooking. You can make temperature and time adjustments if desired.
3. The unit will cook at the programmed settings.
4. There are 100 preset programs already programmed into the Duet (#1-100). There are an additional 80 memory slots for you to save your own unique recipes (#101-180).

### **Program Your Own Recipe Before Cooking:**

1. Set cooking functions, as described in this manual, to your specifications.
2. Press the PROG button. The display will show air fry, prog, and 101.
3. Use the START/PAUSE dial to choose the desired program number to save the program to (101-180).
4. Once the program number is chosen, press the PROG button again to store and save the program to your chosen program number. The program is now stored and available for future recall.
5. Press the START/PAUSE button to begin cooking the program.

### **Program Your Own Recipe During Cooking:**

1. Set cooking functions, as described in this manual, to your specifications.

2. Press the START/PAUSE button to begin cooking.
3. During cooking, press the PROG button. The display will show air fry, prog, and 101.
4. Use the START/PAUSE dial to choose the desired program number to save the program to (101-180).
5. Once the program number is chosen, press the PROG button again to store and save the program to your chosen program number. The program is now stored and available for future recall.
6. The unit will continue to cook the recipe programmed.

**Program Your Own Recipe After cooking:**

1. Set cooking functions, as described in this manual, to your specifications.
2. Press the START/PAUSE button to begin cooking.
3. When the cooking process is finished, and the display shows End, press the PROGRAM button. The display will show air fry, prog, and 101.
4. Use the START/PAUSE dial to choose the desired program number to save the program to (101-180).
5. Once the program number is chosen, press the PROG button again to store and save the program to your chosen program number. The program is now stored and available for future recall.

**View Current Program During Cooking:** You can view the currently cooking program number.

1. During cooking, press and hold the PROGRAM button for 2 seconds.
2. The display will show the currently running program.
3. Release the PROGRAM button to see the previous screen on the display.

**View Programmed Cooking Functions:** You can view all cooking functions associated with a program before or during the cooking process.

1. View Before cooking:
  - Press the PROG button and find the program number to review using the START/PAUSE dial.
  - Once the program number shows in the display, press the STAGE button to review each phase of cooking.

## AIR FRYING INSTRUCTIONS

---

- Adjustments to temperature and time can be made for each function at this time.
2. View During cooking:
    - Press the STAGE button to review each phase of cooking.
    - Continue to press the STAGE button to scroll through all programmed functions for that program number.
    - Adjustments to temperature and time can be made for each function at this time.
    - Editing a Program: You can edit the programs you create before or during the cooking process and save any changes.
  1. Edit Before Cooking:
    - Press the PROG button and find the program number to edit using the START/PAUSE dial.
    - Once the program number shows in the display, press the STAGE button until the function you would like to edit shows in the display.
    - Using the TEMP, TIME, and START/PAUSE dial, make the edits to temperature and time as desired.
    - Once all edits are made, press the PROG button. The display will show air fry, prog, and 101.
    - Use the START/PAUSE dial to find the program number to save your edits to.
    - Press the PROG button again to save and store the edits.
  2. Edit During Cooking:
    - During cooking, press the TEMP button and use the START/PAUSE dial to adjust the cooking temperature.
    - Press the TIME button and use the START/PAUSE dial to adjust the cooking time.
    - If there are more cooking functions that you would like to edit, press the STAGE button until you reach the function you would like to edit.
    - Use the TEMP, TIME, and START/PAUSE dial to make edits.
    - The Duet will continue the cooking process with the edits that you have made.

**Note:** Functions that have already ended in the cooking cycle cannot be adjusted.

- Once all edits are made, press the PROG button. The display will show air fry, prog, and 101.
- Use the START/PAUSE dial to find the program number to save your edits to.
- Press the PROG button again to save and store the edits.
- When cooking has finished, the unit will beep 3 times and the display will show End followed by SAVE.

**Note:** If you save any recipe to an already filled memory slot, the new recipe will override the previous recipe. Any edits to a preset program (1-100) can only be saved and stored into program numbers 101-180. You cannot save and adjust preset program to its original preset program number.

# COMBO COOKING INSTRUCTIONS

---

## COMBO COOK

Combo cooking allows you to set both pressure cooker settings and air fryer settings at the beginning instead of programming in the middle of cooking. The PRESSURE, TEMP, TIME, DELAY, SEAR, STAGE, WARM, and PROG buttons are available for use with the Combo Cook function.

1. Plug the power cord into an electrical outlet. The Duet will power on and the display will show --:--.
2. Press the COMBO COOK button.
  - The lights on the PRESSURE, TIME, DELAY, SEAR, PROG, and WARM buttons will light up, indicating those functions are available for use. The display will show pressure cook, high, 00:30, and time.
3. Set the pressure cooker settings (see the PRESSURE COOK FUNCTIONS section).
4. Once pressure cooker settings have been entered, press the COMBO COOK button a second time.
  - The lights on the SEAR, STAGE, TEMP, TIME, PROG, and WARM buttons will light up, indicating those functions are available for use.
  - The display will show air fry, temp, and 360F.
5. Set the air fryer settings (see the AIR FRY FUNCTIONS section).
6. Press the START/PAUSE button when all settings are entered and the pressure-cooking portion of your cooking is ready to go. Make sure the Pressure Cooker Lid is properly in place. The Duet will first cook the pressure cooker part of the recipe.

7. To natural release pressure, turn the Duet off and unplug. Allow the Duet to naturally release the pressure. To quick release pressure, carefully turn the Pressure Release Switch/Valve to the “OPEN” position until all steam/pressure is released. **Remember to always turn the Pressure Release Switch/Valve to the “OPEN” position before opening the Pressure Cooker Lid to ensure all pressure is released.**
8. Replace the Pressure Cooker Lid with the Air Fryer Lid.
9. Press the START/PAUSE button again to resume the air-frying portion of cooking.
10. When all cooking is complete, the unit will beep 3 times and the display will show End.

**Note:** The Program function works the same as it does in both the PRESSURE COOK and AIR FRY sections with one difference: In order to activate the COMBO COOK, you will need to press the COMBO COOK button. This will allow you access and save preset programs for COMBO COOK.

# CLEANING & MAINTENANCE

---

## Before First Use:

1. Remove all the packaging materials.
2. Remove the glue and labels on the appliance.
3. Clean the Stainless Steel Inner Pot, Stainless Steel Reversible rack, Non-Stick Air Fry Basket, and Air Fry Basket Diffuser thoroughly with hot water, a nonabrasive sponge, and mild dish detergent, or in the dishwasher, top rack only. Wipe the insides and outside of the Duet with a wet cloth. Do not immerse the Duet in water. Dry thoroughly.

**Note:** This appliance also cooks using hot air. DO NOT fill the Duet with oil when air-frying.

## Cleaning

ALWAYS turn off, unplug, and allow the Duet and all parts to completely cool down BEFORE cleaning. Clean the Duet after each use. Removing parts from the unit will allow the Duet to cool down faster.

**IMPORTANT - Do not immerse base and lids in water or attempt to cycle through dishwasher. The outer surface may be cleaned by wiping carefully with a damp dishcloth or sponge. Make sure unit has cooled completely prior to cleaning.**

**DO NOT USE HARSH ABRASIVES OR SCOURING PADS TO CLEAN DUET OR ANY PARTS, as scratching the surfaces may occur.**

1. Unplug the Duet and allow to cool.
2. Clean the Base, Lids, and control panel of Duet with a damp cloth or paper towel. Dry thoroughly.
3. Clean the Stainless Steel Inner Pot with warm or hot water and mild detergent. Dry thoroughly before returning to Duet. For tougher cooked-on food particles soak Pot in warm water first. Use a soft brush or cloth to remove particles.



4. The Pressure Cooker Lid can be cleaned with water and mild detergent soap. Dry thoroughly. DO NOT clean in the dishwasher.
5. The Food Blocking Cap is removable. Wash using water and mild detergent. Return to unit when dry. The Duet will not operate properly without part installed.
6. The Non-Stick Air Fry Basket can be cleaned using water and a soft cloth or paper towel. Or, clean in the dishwasher, top rack only. For tougher particles, soak with hot water before cleaning with a soft cloth.
7. Clean the Air Fryer Lid by wiping the outside and insides with a wet cloth or paper towel. Dry thoroughly. DO NOT clean in the dishwasher.
8. Clean the Air Fry Basket Diffuser thoroughly with warm or hot water, a nonabrasive sponge, and mild dish detergent, or in the dishwasher, top rack only.
9. Gently clean the Pressure Release Switch/Valve with a damp, soft cloth or paper towel.
10. Clean the Stainless Steel Reversible Rack with hot water and a nonabrasive sponge. For tough buildup, soak before removing particles with a soft brush, cloth, or paper towels.

**Note:** Dry all parts gently with a clean, dry cloth or paper towel or air-dry before returning to appliance.

### **Cleaning and Removing the Silicone Gasket from Pressure Cooker Lid**

**MAKE SURE THE SILICONE GASKET HAS NO CRACKS OR IS IN ANY WAY DAMAGED. THE SILICONE GASKET MUST BE INSTALLED IN LID FOR PRESSURE COOKER FUNCTION OF DUET TO WORK.**

#### **Removing the Silicone Gasket**

- With one hand holding the Lid down, gently pull the Silicone Gasket up from the Pressure Cooker Lid.

#### **Installing the Silicone Gasket**

- Line up the Silicone Gasket on top of the metal ring.
- Gently push the Silicone Gasket, making sure you see the metal ring is inside the Silicone Gasket's groove. Continue pushing the Silicone Gasket all around.

# CLEANING & MAINTENANCE

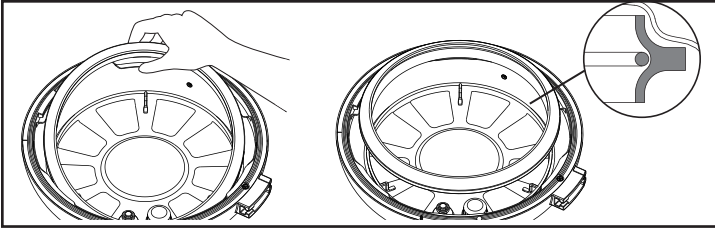

**Note:** Clean the Silicone Gasket under lightly running warm water. Allow to air-dry.

## Air Fryer Lid Holder

Use Air Fryer Lid Holder for Air Fryer Lid only to prevent from touching hot surfaces. Place on Lid Holder to cool down Air Fryer Lid.

1. Place bottom of Air Fryer Lid on two lower horizontal bars with rim resting in between each.
2. Allow Lid to lean against the curved bar of Lid Holder.
3. Ensure Lid is correctly in place and secure on Holder.

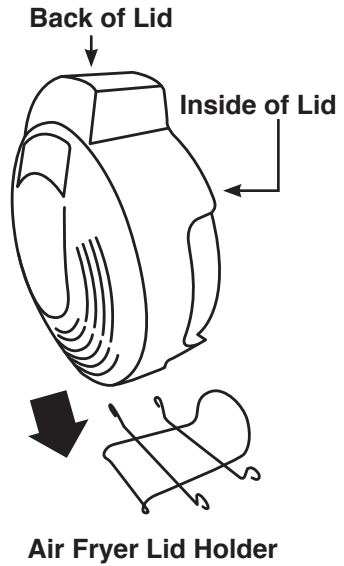

# TROUBLESHOOT GUIDE

## French fries are not crispy when they come out of the Duet.

1. The crispiness of the fries depends on the amount of oil and water in the fries.
2. Make sure you dry the potato sticks properly before adding oil. Cut the potato sticks smaller and dry them for a crispier result. Add slightly more oil on potatoes before placing in the Duet for a crispier result.

If the unit needs to be replaced or returned to the manufacturer, contact Customer Service at: **1-877-689-2838** or **help@nuwavenow.com**.

Error Message:	Solution(s):
<b>LID</b>	Lid not in correct position. Place Lid on unit securely and in the correct position for cooking function.  Wrong Lid was placed on the unit for cooking function. Use the correct Lid for the cooking function performed.
<b>POT</b>	Pot was not placed in the unit or is not in correctly. Place pot in unit before cooking. Make sure the pot is placed in appliance correctly.
<b>Er1</b>	Turn the unit off and unplug to cool. If still not working after cooling and turned on, contact Customer Service.
<b>Err1</b>	NTC Temperature Sensor Short Circuit. Contact Customer Service.
<b>Err2</b>	NTC Temperature Sensor Open. Contact Customer Service.
<b>Err5</b>	The unit has a faulty Pressure sensor. Contact Customer Service.
<b>Err6</b>	The unit has a faulty HIGH Pressure sensor. Contact Customer Service.
<b>Err7</b>	The unit has a faulty LOW Pressure sensor. Contact Customer Service.

# LIMITED WARRANTY

---

## **The NuWave Duet™ Pressure Cooker & Air Fryer Combo THE MANUFACTURER WARRANTIES**

The Duet, including the Stainless Steel Inner Pot, Stainless Steel Reversible Rack, Air Fryer Basket, Air Fryer Basket Diffuser, and Water-Collection Tray are to be free from manufacturer defects.

All electrical components are warranted for 1 year from the date of purchase, under normal household use, and when operated in accordance with the Manufacturer's written instructions. The Manufacturer will provide the necessary parts and labor to repair any part of the Duet at NuWave LLC Service Department. After the expiration of the warranty, the cost of the labor and parts will be the responsibility of the owner.

### **THE WARRANTY DOES NOT COVER**

The Limited Warranty is voided if repairs are made by an unauthorized dealer or the serial number data plate is removed or defaced. Normal deterioration of finish due to use or exposure is not covered by this Warranty. This Limited Warranty does not cover failure, damages or inadequate performance due to accident, acts of God (such as lightning), fluctuations in electric power, alterations, abuse, misuse, misapplications, corrosive-type atmospheres, improper installation, failure to operate in accordance with the Manufacturer's written instructions, abnormal use or commercial use. NuWave LLC reserves the right to void the Limited Warranty, where allowable by law, for products purchased from an unauthorized dealer.

### **TO OBTAIN SERVICE**

The owner shall have the obligation and responsibility to: pay for all services and parts not covered by the warranty; prepay the freight to and from Service Department for any part or system returned under this warranty; and carefully package the product using adequate padding material to prevent damage in transit. The original container is ideal for this purpose. Include in the package the owner's name, address, daytime telephone number, a detailed description of the problem, and your "**RGA number.**" (Call 1-877-689-2838) or email [help@nuwavenow.com](mailto:help@nuwavenow.com) to obtain the **RGA number (Return Goods Authorization number)**. Provide the cooking system model & serial number and proof of date of purchase (a copy of the receipt) when making claims under this warranty.

**MANUFACTURER'S OBLIGATION**









The Manufacturer's obligation under this Limited Warranty is limited, to the extent allowable by law, to repairing or replacing any part covered by this Limited Warranty which upon examination is found to be defective under normal use. The Limited Warranty is applicable only within the continental United States and only to the original purchaser of the manufacturer's authorized channels of distribution. THE LIMITED WARRANTY MAY NOT BE ALTERED, VARIED OR EXTENDED EXCEPT BY A WRITTEN INSTRUMENT EXECUTED BY THE MANUFACTURER. THE REMEDY OF REPAIR OR REPLACEMENT AS PROVIDED UNDER THIS LIMITED WARRANTY IS EXCLUSIVE. IN NO EVENT SHALL THE MANUFACTURER BE LIABLE FOR ANY CONSEQUENTIAL OR INCIDENTAL DAMAGES TO ANY PERSON, WHETHER OR NOT OCCASIONED BY NEGLIGENCE OF THE MANUFACTURER, INCLUDING WITHOUT LIMITATION, DAMAGES FOR LOSS OF USE, COSTS OF SUBSTITUTION, PROPERTY DAMAGE, OR OTHER MONEY LOSS.

Some states do not allow the exclusion or limitation of incidental or consequential damages, so the above limitation exclusions may not apply. This Limited Warranty gives specific legal rights, and there may also be other rights which vary from state to state. EXCEPT AS OTHERWISE EXPRESSLY PROVIDED ABOVE, THE MANUFACTURER MAKES NO WARRANTIES EXPRESSED OR IMPLIED ARISING BY LAW OR OTHERWISE, INCLUDING WITHOUT LIMITATION, THE IMPLIED WARRANTIES OF MERCHANTABILITY AND FITNESS FOR A PARTICULAR PURPOSE TO ANY OTHER PERSON. READ YOUR OWNER'S MANUAL. IF YOU STILL HAVE ANY QUESTIONS ABOUT OPERATION OR WARRANTY OF THE PRODUCT, PLEASE CONTACT NUWAVE LLC.

**READ YOUR OWNER'S MANUAL**

If you still have any questions about operation or warranty of the product, please contact **NuWave LLC at: 1-877-689-2838 or email [help@nuwavenow.com](mailto:help@nuwavenow.com)**.

# REPLACEABLE PARTS

To order replaceable parts head over to <a href="http://NuWaveNow.com">NuWaveNow.com</a>	
	Part Name
	Air Fryer Lid
	Pressure Cooker Lid
	Stainless Steel Reversible Rack
	Non-Stick Air Fry Basket
	Air Fry Basket Diffuser
	Stainless Steel Inner Pot
	Water-Collection Tray
	Duet™ Base

Part Description	Part No.
Used on top of Duet when air-frying foods.	34805
Used on top of Duet when pressure-cooking foods.	34802
Provides high or low positioning of food items in Duet, during pressure-cooking or air-frying. Fits inside Stainless Steel Inner Pot.	34808
Removable basket helps crisp up foods when air-frying.	34806
Keeps Air Fry Basket up from touching bottom to create free flow of air under food when air-frying. Placed underneath Air Fry Basket.	34807
Used to place food items in when pressure cooking. Includes fill lines for proper measurement of food and liquids.	34803
Removable tray on outside of Duet collects excess liquid created by steam when pressure-cooking. Allows easy removal of water.	34804
Contact Customer Service for more information or repair: 1-877-689-2838 or <a href="mailto:help@nuwavenow.com">help@nuwavenow.com</a> .	34801 (Gray) 34816 (Red)

# REPLACEABLE PARTS

To order replaceable parts head over to <a href="https://www.nuwavenow.com">NuWaveNow.com</a>	
	Part Name
	Pressure Indicator Valve
	Silicone Valve Holder
	Pressure Release Switch/Valve
	Food Blocking Cap
	Silicone Gasket
	Start/Pause Dial
	Air Fryer Lid Holder

Part Description	Part No.
Located in the Lid, protrudes or lowers to indicate pressure levels inside the Duet. When up, pressure has built; when down, there is not sufficient or no pressure.	34809
Under the Lid, attaches the Pressure Indicator Valve to the underneath of Lid.	34810
Located on top of Lid, releases and encloses pressure within the unit.	34811
Prevents food and debris from entering pressure cooker components from underneath the Lid.	34812
Under the rim of the Pressure Cooker Lid. Provides an airtight seal between the Lid and Base when pressure-cooking.	34813
On the control panel, adjusts temperature and time, and all functions and begins cooking process (button).	34814
Holds the Air Fryer Lid upright and off of surfaces.	34815

**Brio® 6-Qt  
Digital Air Fryer**



**Nutri-Pot® 6-Qt  
Digital Pressure Cooker**



**NuWave Primo™  
Combo Grill Oven**



**NuWave PIC® Gold  
Precision Induction Cooktop**



**BruHub®  
Coffee Maker**



**Moxie® High-Performance  
Vacuum Blender**



**Bravo™ Air Fry & Toaster Oven  
with Digital Temperature Probe**

**nuwave®**  
— LIVE WELL FOR LESS —

[nuwavenow.com](http://nuwavenow.com)



**FOR HOUSEHOLD USE ONLY**

Model: 33801, 33803

120V, 60Hz, 1500 Watts

For patent information please go to:

[www.nuwavenow.com/legal/patent](http://www.nuwavenow.com/legal/patent)

Designed & Developed in USA by:

**NuWave LLC**

1795 N. Butterfield Road

Libertyville, IL 60048, U.S.A.

**Customer Service:**

1-877-689-2838 • [help@nuwavenow.com](mailto:help@nuwavenow.com)

Made in China

©2019 NuWave LLC • All Rights Reserved.

Item No: BM 33801

Rev. 01-OG

05-22-19

RB02 DV02