

Wireless Noise Canceling Stereo Headset
WH-1000XM4



Use this manual if you encounter any problems, or have any questions.

Update the software of the headset and “Sony | Headphones Connect” app to the latest version. For details, refer to the following:

<https://www.sony.net/elesupport/>

Getting started

[What you can do with the Bluetooth function](#)

[About the voice guidance](#)

Supplied accessories

[Checking the package contents](#)

[Setting the headset in the carrying case](#)

Parts and controls

[Location and function of parts](#)

[About the indicator](#)

[Wearing the headset](#)

Power/Charging

- [Charging the headset](#)

- [Available operating time](#)

- [Checking the remaining battery charge](#)

- [Turning on the headset](#)

- [Turning off the headset](#)

Making connections

[How to make a wireless connection to Bluetooth devices](#)

Easy setup with app

- [Connecting with the "Sony | Headphones Connect" app](#)

Android smartphone

- [Pairing and connecting with an Android smartphone](#)

- [Connecting to a paired Android smartphone](#)

- [One-touch connection \(NFC\) with an Android smartphone](#)

- [Disconnecting the Android smartphone with one-touch \(NFC\)](#)

- [Switching the device by one-touch \(NFC\)](#)

iPhone (iOS devices)

- [Pairing and connecting with an iPhone](#)

- [Connecting to a paired iPhone](#)

Computers

- [Pairing and connecting with a computer \(Windows 10\)](#)

- [Pairing and connecting with a computer \(Windows 8.1\)](#)

- [Pairing and connecting with a computer \(Mac\)](#)

- [Connecting to a paired computer \(Windows 10\)](#)

- [Connecting to a paired computer \(Windows 8.1\)](#)

- [Connecting to a paired computer \(Mac\)](#)

Other Bluetooth devices

- [Pairing and connecting with a Bluetooth device](#)

- [Connecting to a paired Bluetooth device](#)

Multipoint connection

- [Connecting the headset to both a music player and a smartphone / mobile phone \(multipoint connection\)](#)

- [Connecting the headset to 2 Android smartphones \(multipoint connection\)](#)

- [Connecting the headset to an Android smartphone and an iPhone \(multipoint connection\)](#)

- [Connecting the headset to 2 devices simultaneously \(multipoint connection\)](#)

[Disconnecting Bluetooth connection \(after use\)](#)

[Using the supplied headphone cable](#)

Listening to music

Listening to music via a Bluetooth connection

- [Listening to music from a device via Bluetooth connection](#)

- [Controlling the audio device \(Bluetooth connection\)](#)

- [Disconnecting Bluetooth connection \(after use\)](#)

Noise canceling function

- [What is noise canceling?](#)

- [Using the noise canceling function](#)

- [Optimizing the noise canceling function to suit the wearer \(NC Optimizer\)](#)

Listening to ambient sound

- [Listening to ambient sound during music playback \(Ambient Sound Mode\)](#)

- [Listening to ambient sound quickly \(Quick Attention Mode\)](#)

- [Speaking with someone while wearing the headset \(Speak-to-Chat\)](#)

Sound quality mode

- [About the sound quality mode](#)

[Supported codecs](#)

[About the DSEE Extreme function](#)

Making phone calls

[Receiving a call](#)

[Making a call](#)

[Functions for a phone call](#)

[Making a video call on a computer](#)

[Disconnecting Bluetooth connection \(after use\)](#)

Using the voice assist function

[Using the Google Assistant](#)

[Using Amazon Alexa](#)

[Using the voice assist function.\(Google app\)](#)

[Using the voice assist function.\(Siri\)](#)

Using the apps

[What you can do with the “Sony_| Headphones Connect” app](#)

[Installing the “Sony_| Headphones Connect” app](#)

[Accessing support information from the “Sony_| Headphones Connect” app](#)

[Updating the headset software](#)

Important information

[Precautions](#)

[License notice](#)

[Trademarks](#)

[Customer support websites](#)

Troubleshooting

[What can I do to solve a problem?](#)

Power/Charging

- [Unable to turn on the headset.](#)

- [Charging cannot be done.](#)

- [Charging time is too long.](#)

- [The headset cannot be charged even if connecting the headset to a computer.](#)

- [The remaining battery charge of the headset is not displayed on the screen of smartphone.](#)

Sound

- [No sound](#)

- [Low sound level](#)

- [Low sound quality](#)

- [Sound skips frequently.](#)

- [The effect of noise canceling is not sufficient.](#)

Bluetooth connection

- [Pairing cannot be done.](#)

- [One-touch connection \(NFC\) does not work.](#)

- [Unable to make a Bluetooth connection.](#)

- [Distorted sound](#)

- [The headset does not operate properly.](#)

- [Cannot hear a person on a call.](#)

- [Low voice from callers](#)

- [The touch sensor control panel does not respond correctly.](#)

Resetting or initializing the headset

- [Resetting the headset](#)

- [Initializing the headset to restore factory settings](#)

Wireless Noise Canceling Stereo Headset
WH-1000XM4

What you can do with the Bluetooth function

The headset uses BLUETOOTH® wireless technology, allowing you to do the following.

Listening to music

You can receive audio signals from a smartphone or music player to enjoy music wirelessly.



Talking on the phone

You can make and receive calls hands-free, while leaving your smartphone or mobile phone in your bag or pocket.



Wireless Noise Canceling Stereo Headset
WH-1000XM4

About the voice guidance

In the factory setting, you will hear the English voice guidance in the following situations via the headset. You can change the language of the voice guidance and turn on/off the voice guidance using “Sony | Headphones Connect” app. For more details, refer to the “Sony | Headphones Connect” app help guide.

https://rd1.sony.net/help/mdr/hpc/h_zz/

- When the headset is turned on: “Power on”
- When the headset is turned off: “Power off”
- When entering pairing mode: “Bluetooth pairing”
- When establishing a Bluetooth connection: “Bluetooth connected”
- For the first multipoint connection, when establishing a Bluetooth connection between the second device and the headset: “Bluetooth 2nd Device Connected” (*)
- For the multipoint connection, when establishing a Bluetooth connection between the first device and the headset: “Bluetooth Device1 Connected” (*)
- For the multipoint connection, when establishing a Bluetooth connection between the second device and the headset: “Bluetooth Device2 Connected” (*)
- When disconnecting a Bluetooth connection: “Bluetooth disconnected”
- For the multipoint connection, when disconnecting the Bluetooth connection between the first device and the headset: “Bluetooth Device1 Disconnected” (*)
- For the multipoint connection, when disconnecting the Bluetooth connection between the second device and the headset: “Bluetooth Device2 Disconnected” (*)
- For the multipoint connection, when connecting the third device to the headset, disconnecting the Bluetooth connection between the first device and the headset, and switching the connection: “Bluetooth Device1 Replaced” (*)
- For the multipoint connection, when connecting the third device to the headset, disconnecting the Bluetooth connection between the second device and the headset, and switching the connection: “Bluetooth Device2 Replaced” (*)
- When informing the remaining battery charge: “Battery about XX %” (The “XX” value indicates the approximate remaining charge. Use it as a rough estimate.) / “Battery fully charged”
- When the remaining battery charge is low: “Low battery, please recharge headset”
- When automatically turning off due to low battery: “Please recharge headset. Power off”
- When turning on the noise canceling function: “Noise canceling”
- When turning on the Ambient Sound Mode: “Ambient sound”
- When turning off the noise canceling function and Ambient Sound Mode: “Ambient Sound Control off”
- When the NC Optimizer starts: “Optimizer start”
- When the NC Optimizer finishes: “Optimizer finished”
- When Speak-to-Chat is enabled: “Speak-to-chat activated”
- When Speak-to-Chat is disabled: “Speak-to-chat deactivated”
- When the Google Assistant is not available on the smartphone connected to the headset even if you press the Google Assistant button on the headset: “The Google Assistant is not connected”
- When the Google Assistant is not available during software update: “The Google assistant is not available during update. Please wait a moment until the update completes.”
- When Amazon Alexa is not available on the smartphone connected to the headset even if you press the Amazon Alexa button on the headset: “Either your mobile device isn’t connected; or you need to open the Alexa App and try again”

* Available only when [Connect to 2 devices simultaneously] is turned to on with the “Sony | Headphones Connect” app.

Note

- It takes about 20 minutes when you change the language of the voice guidance.
- When you initialize the headset to restore the factory settings after you change the language of the voice guidance, the language will also return to the factory setting.

- If the voice guidance is not heard after changing the voice guidance language or updating the software, turn the headset off and on again.

5-013-731-11(4) Copyright 2020 Sony Corporation

Wireless Noise Canceling Stereo Headset
WH-1000XM4

Checking the package contents

After opening the package, check that all of the items in the list are included. If any items are missing, contact your dealer.

Numbers in () indicate the item amount.

Wireless Noise Canceling Stereo Headset

USB Type-C® cable (USB-A to USB-C®) (approx. 20 cm (7.88 in.)) (1)



Headphone cable (approx. 1.2 m (47.25 in.)) (1)



Carrying case (1)

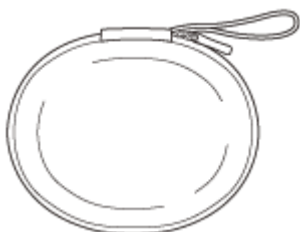

Plug adaptor for in-flight use (1)

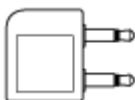

Wireless Noise Canceling Stereo Headset
WH-1000XM4

Setting the headset in the carrying case

When you have finished using the headset, rotate the left and right units to flatten the headset, fold one unit toward the headband, and store them in the supplied carrying case.

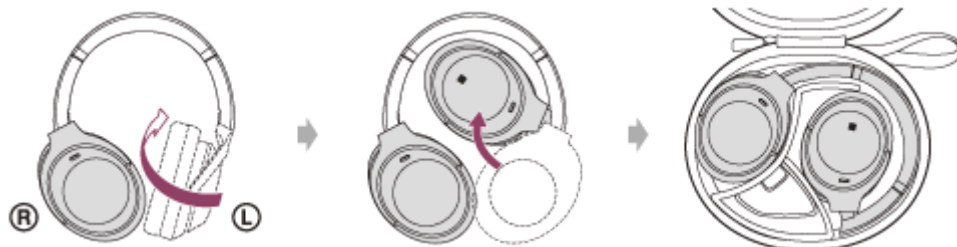

To store the cables and plug adaptor for in-flight use

Put the cables and plug adaptor for in-flight use in the holder separated by the divider in the carrying case.

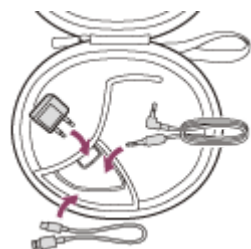

Location and function of parts

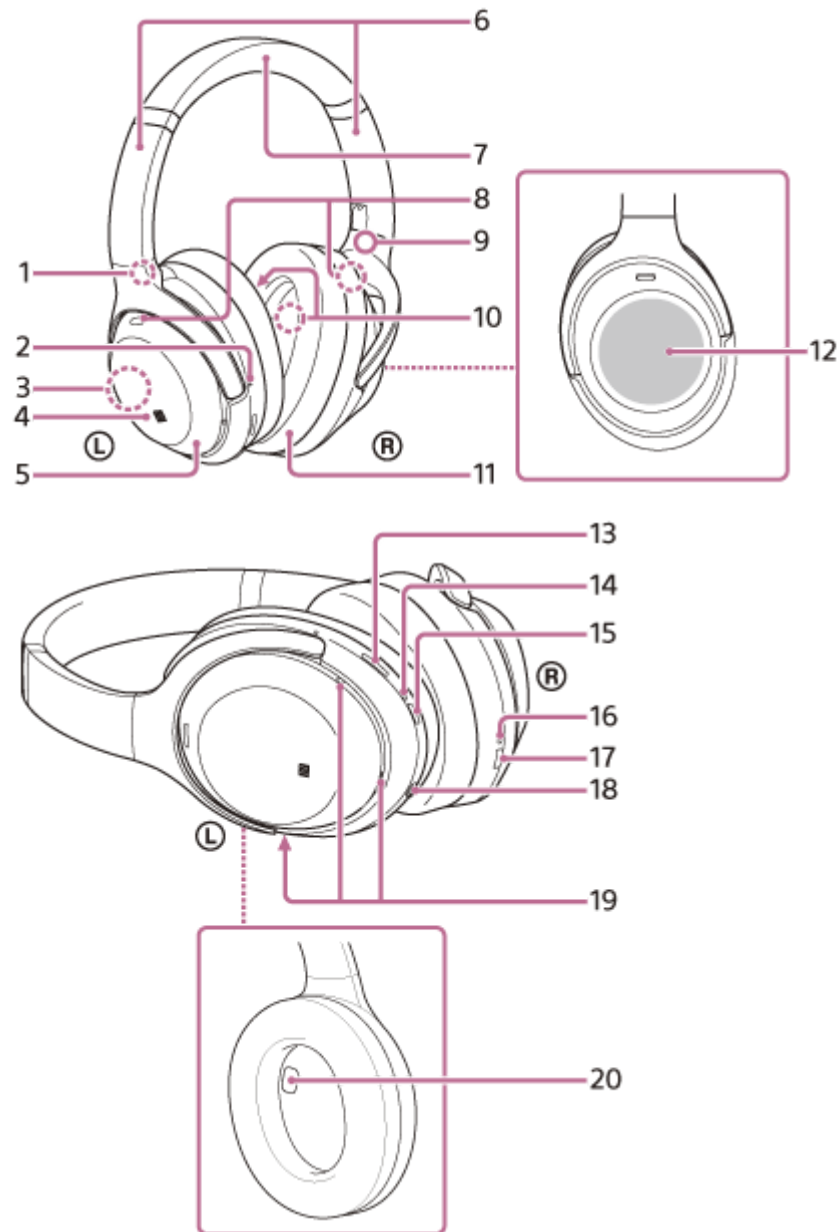

1. Ⓛ (left) mark
2. Tactile dot
There is a tactile dot on the left unit.
3. Built-in antenna
A Bluetooth antenna is built into the headset.
4. N-Mark
5. Left unit
6. Sliders (left, right)
Slide to adjust the length of the headband.
7. Headband
8. Noise canceling function microphones (external) (left, right)
Pick up the sound of the noise when the noise canceling function is in use.
9. Ⓜ (right) mark
10. Noise canceling function microphones (internal) (left, right)
Pick up the sound of the noise when the noise canceling function is in use.

11. Right unit
12. Touch sensor control panel
Remotely controls music playback of the connected Bluetooth device or performs other operations using touch operation.
13. CUSTOM button
Operate when switching the noise canceling function and Ambient Sound Mode, etc.
14. Indicator (red/blue)
Lights up in red or blue to indicate the power or communication status of the headset.
15.  (power) button
16. Charging indicator (red)
Lights up in red while charging.
17. USB Type-C port
Connect the headset to an AC outlet via a commercially available USB AC adaptor or to a computer with the supplied USB Type-C cable to charge the headset.
18. Headphone cable input jack
Connect a music player, etc. using the supplied headphone cable. Make sure that you insert the cable until it clicks. If the plug is not connected correctly, you may not hear the sound properly.
19. Voice pickup microphones
Pick up the sound of your voice when talking on the phone or in the Speak-to-Chat mode.
20. Proximity sensor
Detects whether the headset is worn on the ears.

Related Topic

- [About the indicator](#)
- [Checking the remaining battery charge](#)

Wireless Noise Canceling Stereo Headset
WH-1000XM4

About the indicator

You can check various statuses of the headset by the indicator.

● : Turns on in blue / ● : Turns on in red / -: Turns off

Indicator (blue/red) next to the (power) button

Turning on

● - ● (flashes twice in blue)

In this case, when the remaining battery charge is 10% or lower (requires charging), the indicator lights successively as follows.

 -  -  (repeatedly flashes slowly in red for about 15 seconds)

Turning off

 (lights up in blue for about 2 seconds)

Displaying the remaining battery charge

- Remaining charge: More than 10%

● - ● (flashes twice in blue)

- Remaining charge: 10% or lower (requires charging)

 -  -  (repeatedly flashes slowly in red for about 15 seconds)

For details, see "[Checking the remaining battery charge](#)".

When the remaining battery charge becomes low

 -  -  (repeatedly flashes slowly in red for about 15 seconds)

Bluetooth function

- Device registration (pairing) mode

● ● -- ● ● -- (repeatedly flashes twice in blue)

- Not connected

● -- ● -- ● -- ● -- (repeatedly flashes in blue at about 1-second intervals)

- Connection process completed

● ● ● ● ● ● ● ● (repeatedly flashes quickly in blue for about 5 seconds)

- Connected

● ----- ● ----- (repeatedly flashes in blue at about 5-second intervals)

- Incoming call

● ● ● ● ● ● ● ● (repeatedly flashes quickly in blue)



The unconnected and connected status indications automatically turn off after a period of time has passed. They start flashing again for a period of time when some operation is performed. When the remaining battery charge becomes low, the indicator starts flashing in red.

Other

- Headphone cable connected (power is turned on)





● ----- ● ----- (repeatedly flashes in blue at about 5-second intervals)

The indicator turns off automatically after a period of time has passed. When the remaining battery charge becomes low, the indicator starts flashing in red.

- Updating software
 -- (repeatedly flashes slowly in blue)
 - Initialization completed
 (flashes 4 times in blue)
- For details, see [“Initializing the headset to restore factory settings”](#).

USB Type-C port charging indicator (red)

Charging

- While charging
 (lights up in red)
The indicator turns off after charging is complete.
- Abnormal temperature
 --  -- (repeatedly flashes twice in red)
- Abnormal charging
 --  -- (repeatedly flashes slowly in red)

Related Topic

- [Checking the remaining battery charge](#)
- [Initializing the headset to restore factory settings](#)

Wearing the headset

1 Put the headset on your ears.

Adjust the length of the headband.

Put the headset on your head with the **Ⓘ** (left) mark on your left ear and the **Ⓡ** (right) mark on your right ear.

There is a tactile dot on the **Ⓘ** (left) mark side.

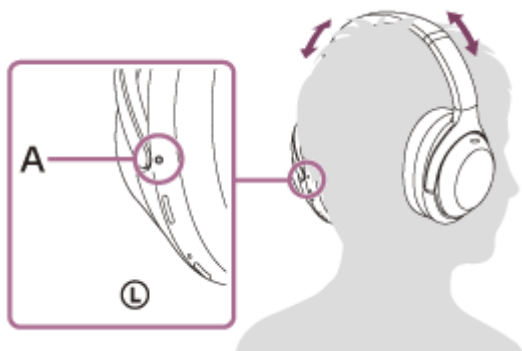

A: Tactile dot

When attaching and removing the headset

In the factory setting, the built-in proximity sensor in the left unit and the built-in acceleration sensors in each of the left and right units detect when the headset is attached to or removed from your ears, and the headset automatically controls the touch sensor control panel's operation, powering off, pausing music playback, etc. (Wearing detection).

When the headset is worn

- The indicator next to the **⏻** (power) button turns off.
- You can use the touch sensor control panel of the headset to play music, make and receive calls, etc.

When the headset is removed

- When you listen to music while wearing the headset on your ears, the headset will pause music playback automatically if the headset is removed. When the headset is worn again, the headset resumes music playback.
- In order to save the battery, the headset will automatically turn off after 15 minutes of not being worn.
- In order to prevent the headset from reacting incorrectly, music playback, making and receiving calls, and other operations cannot be performed when the headset is removed, even if you tap the touch sensor control panel.
- When you are talking on the headset while wearing the headset on your ears, the call is automatically switched to the smartphone or mobile phone if the headset is removed. When you put the headset on your ears again, the call is switched to the headset.

Hint

- By using the “Sony | Headphones Connect” app, you can change the settings of the wearing detection automatic music playback pause and resume function and the wearing detection automatic power off function (the battery saving function).

Note

- In the following cases, wearing detection may react incorrectly.
 - With the headset around your neck, your chin goes into the housing



– Put your hand inside the earpad of the left unit



– Put the headset up and put it in a bag, etc.



– Put the headset up and hang it on a bag, etc.



- When you wear the headset with your face up or down as shown below, or when you wear the headset upside down, wearing detection may not work properly, and the touch sensor control panel and CUSTOM button may not be available for operation. Wear the headset correctly while facing forward, or press the  (power) button briefly.

– Wearing the headset while lying down or with your face up



– Wearing the headset with your face down



- When you wear the headset over a cap, a scarf, hair, etc., wearing detection may not work properly, and the touch sensor control panel may not be available for operation. Wear the headset so that your ears are inside the earpads.
- When the supplied headphone cable is connected to the headset, wearing detection does not work.
- The wearing detection automatic music playback pause and resume function is only available when connected via Bluetooth connection.
- The connected device or playback application you are using may not support the wearing detection automatic music playback pause and resume function.
- When attaching and removing the headset, the call is switched only when the wearing detection automatic power off function is enabled.
- If the proximity sensor part inside the left unit housing gets fogged up or there are water droplets on it due to condensation or humidity from sweat, etc., wearing detection may not work properly. When the sensor part is fogged up or there are water droplets on it, leave the proximity sensor part facing up until the moisture disappears.

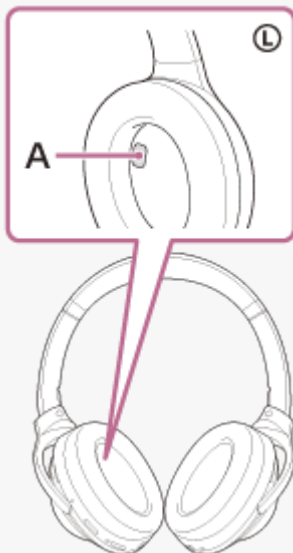

A: Proximity sensor part

Related Topic

- [What you can do with the “Sony | Headphones Connect” app](#)

Wireless Noise Canceling Stereo Headset
WH-1000XM4

Charging the headset

The headset contains a built-in lithium-ion rechargeable battery. Use the supplied USB Type-C cable to charge the headset before use.

1 Connect the headset to an AC outlet.

Use the supplied USB Type-C cable and a commercially available USB AC adaptor.

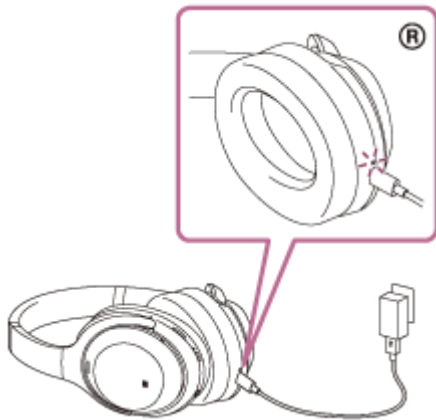

- The charging indicator (red) of the headset lights up.
- Charging is completed in about 3 hours (*) and the indicator turns off automatically.

* Time required for charging the empty battery to its full capacity. The charging time may differ depending on the conditions of use.

After charging is complete, disconnect the USB Type-C cable.

System requirements for battery charge using USB

USB AC adaptor

A commercially available USB AC adaptor capable of supplying an output current of 1.5 A or more (If the output current is less than 1.5 A, the charging time will increase, and the music playback time after 10 minutes of charging will decrease.)

Personal computer

Personal computer with a standard USB port

- We do not guarantee operation on all computers.
- Operations using a custom-built or homebuilt computer are not guaranteed.

Hint

- The headset can be also charged by connecting the headset to a running computer using the supplied USB Type-C cable.
- If charging starts while the headset is on, the headset will turn off automatically.

Note

- Charging may not be successful with cables other than the supplied USB Type-C cable.
- Charging may not be successful depending on the type of USB AC adaptor.

- When the headset is connected to an AC outlet or computer, all operations such as turning on the headset, registering or connecting to Bluetooth devices, and music playback cannot be performed.
- The headset cannot be charged when the computer goes into standby (sleep) or hibernation mode. In this case, change the computer settings, and start charging the headset once again.
- If the headset is not used for a long time, the rechargeable battery usage hours may be reduced. However, the battery life will improve after a few recharges. If you store the headset for a long time, charge the battery to its full capacity once every 6 months to avoid over-discharge.
- If the headset is not used for a long time, it may take longer to charge the battery.
- If the headset detects a problem while charging due to the following causes, the charging indicator (red) flashes. In this case, charge once again within the charging temperature range. If the problem persists, consult your nearest Sony dealer.
 - Ambient temperature exceeds the charging temperature range of 5 °C - 35 °C (41 °F - 95 °F).
 - There is a problem with the rechargeable battery.
- If the headset is not used for a long time, the charging indicator (red) may not immediately light up when charging. Please wait a moment until the indicator lights up.
- If the usage hours of the built-in rechargeable battery decrease significantly, the battery should be replaced. Consult your nearest Sony dealer to replace the rechargeable battery.
- Avoid exposure to extreme temperature changes, direct sunlight, moisture, sand, dust, and electrical shock. Never leave the headset in a parked vehicle.
- When connecting the headset to a computer, use only the supplied USB Type-C cable, and be sure to directly connect them. Charging will not be properly completed when the headset is connected through a USB hub.

Available operating time

The available operating times of the headset with the battery fully charged are as follows:

Bluetooth connection

Music playback time

Codec	DSEE Extreme™	Speak-to-Chat	Noise canceling function/Ambient Sound Mode	Available operating time
LDAC™	AUTO	OFF	Noise canceling function: ON	Max. 16 hours
LDAC	AUTO	OFF	Ambient Sound Mode: ON	Max. 14 hours
LDAC	AUTO	OFF	OFF	Max. 20 hours
LDAC	OFF	OFF	Noise canceling function: ON	Max. 24 hours
LDAC	OFF	OFF	Ambient Sound Mode: ON	Max. 18 hours
LDAC	OFF	OFF	OFF	Max. 30 hours
AAC	AUTO	OFF	Noise canceling function: ON	Max. 18 hours
AAC	AUTO	OFF	Ambient Sound Mode: ON	Max. 16 hours
AAC	AUTO	OFF	OFF	Max. 22 hours
AAC	OFF	OFF	Noise canceling function: ON	Max. 30 hours
AAC	OFF	OFF	Ambient Sound Mode: ON	Max. 22 hours
AAC	OFF	OFF	OFF	Max. 38 hours
SBC	AUTO	OFF	Noise canceling function: ON	Max. 18 hours
SBC	AUTO	OFF	Ambient Sound Mode: ON	Max. 16 hours
SBC	AUTO	OFF	OFF	Max. 22 hours
SBC	OFF	OFF	Noise canceling function: ON	Max. 30 hours
SBC	OFF	OFF	Ambient Sound Mode: ON	Max. 22 hours
SBC	OFF	OFF	OFF	Max. 38 hours

- About 5 hours of music playback is possible after 10 minutes charging.
- When Speak-to-Chat is set to “Enable (ON)”, the available operating time is shortened by about 30% compared to the case of “Disable (OFF)”.

Communication time

Noise canceling function/Ambient Sound Mode	Available operating time
Noise canceling function: ON	Max. 24 hours
Ambient Sound Mode: ON	Max. 18 hours

Noise canceling function/Ambient Sound Mode	Available operating time
OFF	Max. 30 hours

Standby time

Noise canceling function/Ambient Sound Mode	Available operating time
Noise canceling function: ON	Max. 30 hours
Ambient Sound Mode: ON	Max. 22 hours
OFF	Max. 200 hours

Headphone cable connected (power is turned on)

Noise canceling function/Ambient Sound Mode	Available operating time
Noise canceling function: ON	Max. 22 hours
Ambient Sound Mode: ON	Max. 18 hours
OFF	Max. 36 hours

Hint

- By using the “Sony | Headphones Connect” app, you can check which codec is used for a connection or switch the DSEE Extreme function.

Note

- Usage hours may be different depending on the settings and conditions of use.

Related Topic

- [Supported codecs](#)
- [About the DSEE Extreme function](#)
- [What you can do with the “Sony | Headphones Connect” app](#)

Wireless Noise Canceling Stereo Headset
WH-1000XM4

Checking the remaining battery charge

You can check the remaining battery charge of the rechargeable battery.

When you press the  (power) button while the headset is on, a voice guidance indicating the remaining battery charge can be heard.

“Battery about XX %” (The “XX” value indicates the approximate remaining charge.)

“Battery fully charged”

The remaining battery charge indicated by the voice guidance may differ from the actual remaining charge in some cases. Please use it as a rough estimate.

In addition, the indicator (red) flashes for about 15 seconds if the remaining battery charge is 10% or lower when the headset is turned on.

When the remaining charge becomes low

A warning beep sounds and the color of the operating indicator (blue) becomes red. If you hear the voice guidance say, “Low battery, please recharge headset”, charge the headset as soon as possible.

When the battery becomes completely empty, a warning beep sounds, the voice guidance says, “Please recharge headset. Power off”, and the headset automatically turns off.

When you are using iPhone or iPod touch

When the headset is connected to an iPhone or iPod touch over an HFP Bluetooth connection, it will show an icon that indicates the remaining battery charge of the headset on the screen of the iPhone or iPod touch.

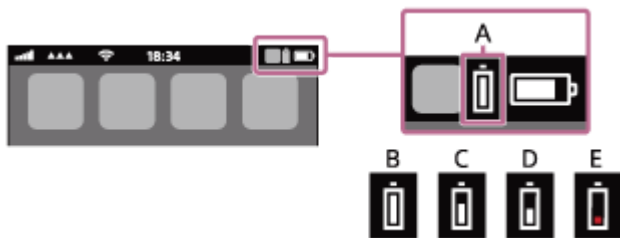

A: Remaining battery charge of the headset

The approximate remaining charge is shown at 10 different levels. B through E are display examples.

B: 100%

C: 70%

D: 50%

E: 10% or lower (requires charging)

The remaining battery charge of the headset is also displayed on the widget of an iPhone or iPod touch running iOS 9 or later. For more details, refer to the operating instructions supplied with the iPhone or iPod touch.

The remaining charge which is displayed may differ from the actual remaining charge in some cases. Please use it as a rough estimate.

When you are using an Android™ smartphone (OS 8.1 or later)

When the headset is connected to an Android smartphone via HFP Bluetooth connection, select [Settings] - [Device connection] - [Bluetooth] to display the remaining battery charge of the headset where the paired Bluetooth device is displayed on the smartphone's screen. It is displayed in 10 different levels such as “100%”, “70%”, “50%”, or “10%”. For details, refer to the operating instructions of the Android smartphone.

The remaining charge which is displayed may differ from the actual remaining charge in some cases. Please use it as a rough estimate.

- You can also check the remaining battery charge with the “Sony | Headphones Connect” app. Android smartphones and iPhone/iPod touch both support this app.

Note

- If you connect the headset to an iPhone/iPod touch or Android smartphone with “Media audio” (A2DP) only in a multipoint connection, the remaining battery charge will not be displayed correctly.
- The remaining battery charge may not be properly displayed immediately after a software update or if the headset has not been used for a long time. In this case, repeatedly charge and discharge the battery multiple times to properly display the remaining battery charge.

Related Topic

- [About the indicator](#)
- [What you can do with the “Sony | Headphones Connect” app](#)

Wireless Noise Canceling Stereo Headset
WH-1000XM4

Turning on the headset

- 1 Press and hold the  (power) button for about 2 seconds until the indicator (blue) flashes.



Related Topic

- [Turning off the headset](#)

Turning off the headset

- 1 Press and hold the  (power) button for about 2 seconds until the indicator (blue) turns off.



Hint

- You can also turn off the headset with the “Sony | Headphones Connect” app.
- The headset will automatically turn off after 15 minutes of not being worn. This setting can be changed using the “Sony | Headphones Connect” app.
- When storing the headset in a bag, etc., turn off the headset. Wearing detection may react incorrectly.

Related Topic

- [Turning on the headset](#)
- [What you can do with the “Sony | Headphones Connect” app](#)

Wireless Noise Canceling Stereo Headset
WH-1000XM4

How to make a wireless connection to Bluetooth devices

You can enjoy music and hands-free calling with the headset wirelessly by using your Bluetooth device's Bluetooth function.

Device registration (pairing)

To use the Bluetooth function, both of the connecting devices must be registered in advance. The operation to register a device is called "device registration (pairing)".

If the device to be connected does not support one-touch connection (NFC), pair the headset and the device manually. If the device supports one-touch connection (NFC), you can pair the headset and device and establish a Bluetooth connection by simply touching the headset with the device.

Connecting to a paired device

Once a device and the headset are paired, there is no need to pair them again. Connect to devices already paired with the headset using the methods necessary for each device.

Wireless Noise Canceling Stereo Headset
WH-1000XM4

Connecting with the “Sony | Headphones Connect” app

Launch the “Sony | Headphones Connect” app on your Android smartphone/iPhone to connect the headset to a smartphone or iPhone. For more details, refer to the “Sony | Headphones Connect” app help guide.

https://rd1.sony.net/help/mdr/hpc/h_zz/



Sony Headphones Connect 

Note

- The connection with some smartphones and iPhone devices may become unstable when connecting using the “Sony | Headphones Connect” app. In that case, follow the procedures in [“Connecting to a paired Android smartphone”](#), or [“Connecting to a paired iPhone”](#) to connect to the headset.

Related Topic

- [Connecting to a paired Android smartphone](#)
- [Connecting to a paired iPhone](#)
- [What you can do with the “Sony | Headphones Connect” app](#)
- [Installing the “Sony | Headphones Connect” app](#)

Wireless Noise Canceling Stereo Headset
WH-1000XM4

Pairing and connecting with an Android smartphone

The operation to register the device that you wish to connect to is called “pairing”. First, pair a device to use it with the headset for the first time.

Before starting the operation, make sure of the following:

- The Android smartphone is placed within 1 m (3 feet) of the headset.
- The headset is charged sufficiently.
- The operating instructions of the Android smartphone is in hand.

1 Enter pairing mode on this headset.

Turn on the headset when you pair the headset with a device for the first time after you bought it or after you initialized the headset (the headset has no pairing information). The headset enters pairing mode automatically. In this case, proceed to step 2.

When you pair a second or subsequent device (the headset has pairing information for other devices), press and hold the  (power) button for about 7 seconds.



Check that the indicator (blue) repeatedly flashes twice in a row. You will hear the voice guidance say, “Bluetooth pairing”.

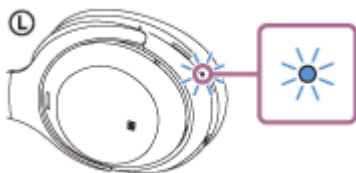

2 Unlock the screen of the Android smartphone if it is locked.

3 Find the headset on the Android smartphone.

1. Select [Settings] - [Device connection] - [Bluetooth].

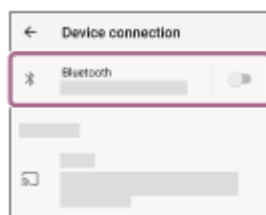

2. Touch the switch to turn on the Bluetooth function.

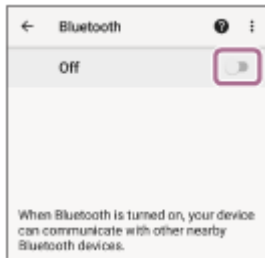

4 Touch [WH-1000XM4].

If [WH-1000XM4] and [LE_WH-1000XM4] are displayed, select [WH-1000XM4].
 [LE_WH-1000XM4] will be displayed first, but wait until [WH-1000XM4] is displayed.
 It may take about 30 seconds to 1 minute for [WH-1000XM4] to be displayed.
 If [WH-1000XM4] is not displayed, try again from step 1.

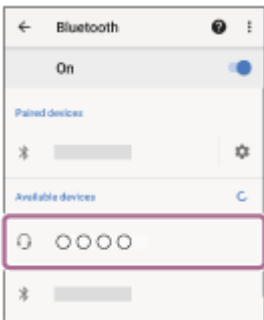

If Passkey (*) input is required, input "0000".

The headset and smartphone are paired and connected with each other. You will hear the voice guidance say, "Bluetooth connected".

If they are not connected, see ["Connecting to a paired Android smartphone"](#).

* A Passkey may be called "Passcode", "PIN code", "PIN number", or "Password".

Hint

- The operation above is an example. For more details, refer to the operating instructions supplied with the Android smartphone.
- To delete all Bluetooth pairing information, see ["Initializing the headset to restore factory settings"](#).

Note

- If pairing is not established within 5 minutes, pairing mode is canceled. In this case, start the operation again from step 1.
- Once Bluetooth devices are paired, there is no need to pair them again, except in the following cases:
 - Pairing information has been deleted after repair, etc.
 - When a 9th device is paired.
 The headset can be paired with up to 8 devices. If a new device is paired after 8 devices are already paired, the registration information of the paired device with the oldest connection date is overwritten with the information for the new device.
 - When the pairing information for the headset has been deleted from the Bluetooth device.
 - When the headset is initialized.
 All of the pairing information is deleted. In this case, delete the pairing information for the headset from the device and then pair them again.
- The headset can be paired with multiple devices, but can only play music from 1 paired device at a time.

Related Topic

- [How to make a wireless connection to Bluetooth devices](#)
- [Connecting to a paired Android smartphone](#)

- Listening to music from a device via Bluetooth connection
- Disconnecting Bluetooth connection (after use)
- Initializing the headset to restore factory settings

5-013-731-11(4) Copyright 2020 Sony Corporation

Connecting to a paired Android smartphone

1 Unlock the screen of the Android smartphone if it is locked.

2 Turn on the headset.

Press and hold the  (power) button for about 2 seconds.

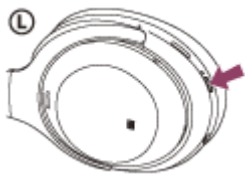

You will hear the voice guidance say, "Power on". Check that the indicator (blue) continues to flash after you release your finger from the button.

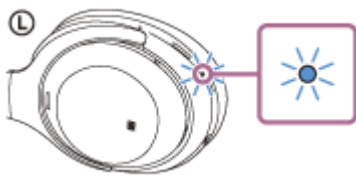

If the headset has automatically connected to the last connected device, you will hear the voice guidance say, "Bluetooth connected".

Check the connection status on the Android smartphone. If it is not connected, proceed to step 3.

3 Display the devices paired with the Android smartphone.

1. Select [Settings] - [Device connection] - [Bluetooth].

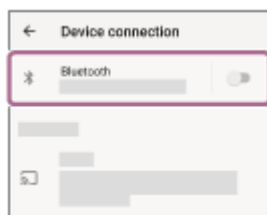

2. Touch the switch to turn on the Bluetooth function.

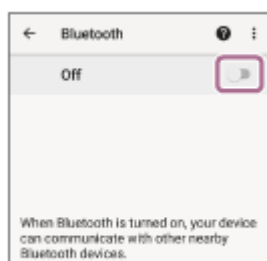

4 Touch [WH-1000XM4].

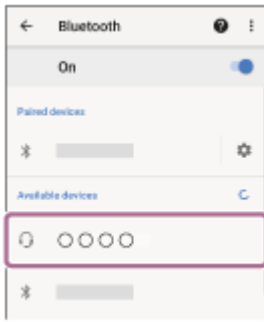

You will hear the voice guidance say, “Bluetooth connected”.

Hint

- The operation above is an example. For more details, refer to the operating instructions supplied with the Android smartphone.

Note

- When connecting, if [WH-1000XM4] and [LE_WH-1000XM4] are displayed, select [WH-1000XM4]. [LE_WH-1000XM4] will be displayed first, but wait until [WH-1000XM4] is displayed. It may take about 30 seconds to 1 minute for [WH-1000XM4] to be displayed. If [WH-1000XM4] is not displayed, perform the pairing again.
- If the last-connected Bluetooth device is placed near the headset, the headset may connect automatically to the device by simply turning on the headset. In that case, deactivate the Bluetooth function on the last-connected device or turn off the power.
- If you cannot connect your smartphone to the headset, delete the headset pairing information on your smartphone and perform the pairing again. As for the operations on your smartphone, refer to the operating instructions supplied with the smartphone.

Related Topic

- [How to make a wireless connection to Bluetooth devices](#)
- [Pairing and connecting with an Android smartphone](#)
- [Listening to music from a device via Bluetooth connection](#)
- [Disconnecting Bluetooth connection \(after use\)](#)

One-touch connection (NFC) with an Android smartphone

By touching the headset with a smartphone, the headset turns on automatically and then pairs and makes a Bluetooth connection.

Compatible smartphones

- NFC-compatible smartphones installed with Android 4.1 or later

What is NFC?

NFC (Near Field Communication) is a technology enabling short-range wireless communication between various devices, such as smartphones and IC tags. Thanks to the NFC function, data communication — for example, Bluetooth pairing — can be achieved easily by simply touching NFC-compatible devices together (i.e., at the N-Mark symbol or location designated on each device).

1 Unlock the screen of the smartphone if it is locked.

2 Turn on the smartphone's NFC function.

1. Select [Settings] - [Device connection].
2. Touch the switch to turn on the NFC function.

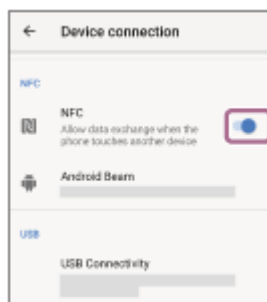

3 Touch the smartphone with the headset.

- Touch the smartphone on the N-Mark of the headset. Keep touching the headset with the smartphone until the smartphone reacts.
- Refer to the operating instructions of the smartphone for the designated location to be touched on the smartphone.

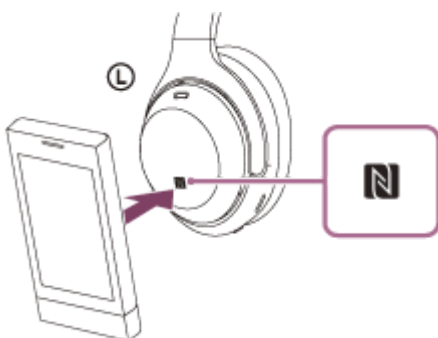

Follow the on-screen instructions to complete the pairing and connection.

When the headset is connected with the smartphone, the indicator (blue) starts flashing slowly. You will hear the voice guidance say, "Bluetooth connected".

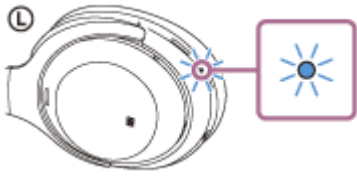

- To disconnect, touch the smartphone again with the headset. You will hear the voice guidance say, “Bluetooth disconnected”.
- To connect a paired smartphone, perform step 3.
- Unlock the screen of the smartphone if it is locked.

Hint

- The operation above is an example. For more details, refer to the operating instructions supplied with the Android smartphone.
- If you cannot connect the headset, try the following.
 - Unlock the screen of the smartphone if it is locked, and move the smartphone slowly over the N-Mark.
 - If the smartphone is in a case, remove the case.
 - Check that the Bluetooth function of the smartphone is enabled.
- If you touch an NFC-compatible smartphone connected to another NFC-compatible device with the headset, the smartphone terminates the Bluetooth connection with any current devices, and connects to the headset via one-touch (NFC) (One-touch connection switching).

Related Topic

- [How to make a wireless connection to Bluetooth devices](#)
- [Disconnecting the Android smartphone with one-touch \(NFC\)](#)
- [Switching the device by one-touch \(NFC\)](#)
- [Listening to music from a device via Bluetooth connection](#)

Disconnecting the Android smartphone with one-touch (NFC)

You can disconnect the headset from the connected smartphone by touching the headset with it.

1 Unlock the screen of the smartphone if it is locked.

2 Touch the smartphone with the headset.

Touch the smartphone to the N-Mark on the headset.

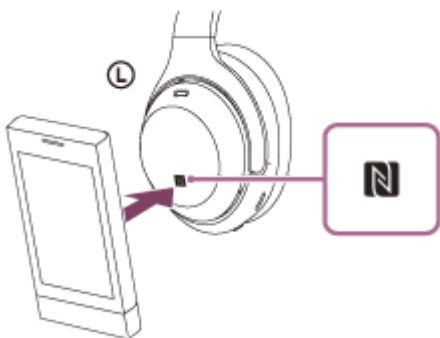

You will hear the voice guidance say, "Bluetooth disconnected".

Note

- In the factory setting, after 15 minutes of not being worn, the headset automatically turns off. Press and hold the  (power) button for about 2 seconds to turn off the power before that time. You will hear the voice guidance say, "Power off", the indicator (blue) turns off, and the headset powers off.

Wireless Noise Canceling Stereo Headset
WH-1000XM4

Switching the device by one-touch (NFC)

- If you touch an NFC-compatible smartphone to the headset while the headset is connected to another Bluetooth device, the connection switches to the smartphone (One-touch connection switching). However, the connection cannot be switched when talking on a headset connected to a Bluetooth-compatible mobile phone.
- When an NFC-compatible smartphone is connected to the headset, if the smartphone is touched by another NFC-compatible Bluetooth headset or Bluetooth speaker, the smartphone is disconnected from the headset and connected to the Bluetooth device.

Note

- Unlock the smartphone screen in advance if it is locked.

Wireless Noise Canceling Stereo Headset
WH-1000XM4

Pairing and connecting with an iPhone

The operation to register the device that you wish to connect to is called “pairing”. First, pair a device to use it with the headset for the first time.

Before starting the operation, make sure of the following:

- The iPhone is placed within 1 m (3 feet) of the headset.
- The headset is charged sufficiently.
- The operating instructions of the iPhone is in hand.

1 Enter pairing mode on this headset.

Turn on the headset when you pair the headset with a device for the first time after you bought it or after you initialized the headset (the headset has no pairing information). The headset enters pairing mode automatically. In this case, proceed to step 2.

When you pair a second or subsequent device (the headset has pairing information for other devices), press and hold the  (power) button for about 7 seconds.



Check that the indicator (blue) repeatedly flashes twice in a row. You will hear the voice guidance say, “Bluetooth pairing”.

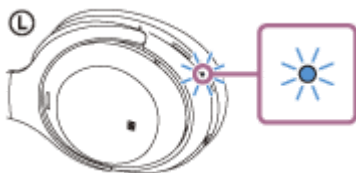

2 Unlock the screen of the iPhone if it is locked.

3 Find the headset on the iPhone.

1. Select [Settings].
2. Touch [Bluetooth].

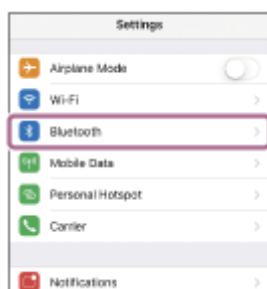

3. Touch the switch to turn on the Bluetooth function.



4 Touch [WH-1000XM4].

If [WH-1000XM4] and [LE_WH-1000XM4] are displayed, select [WH-1000XM4]. [LE_WH-1000XM4] will be displayed first, but wait until [WH-1000XM4] is displayed. It may take about 30 seconds to 1 minute for [WH-1000XM4] to be displayed. If [WH-1000XM4] is not displayed, try again from step 1.

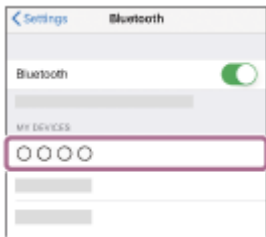

If Passkey (*) input is required, input “0000”.
The headset and iPhone are paired and connected with each other. You will hear the voice guidance say, “Bluetooth connected”.
If they are not connected, see [“Connecting to a paired iPhone”](#).

* A Passkey may be called “Passcode”, “PIN code”, “PIN number”, or “Password”.

Hint

- The operation above is an example. For more details, refer to the operating instructions supplied with your iPhone.
- To delete all Bluetooth pairing information, see [“Initializing the headset to restore factory settings”](#).

Note

- If pairing is not established within 5 minutes, pairing mode is canceled. In this case, start the operation again from step 1.
- Once Bluetooth devices are paired, there is no need to pair them again, except in the following cases:
 - Pairing information has been deleted after repair, etc.
 - When a 9th device is paired.
The headset can be paired with up to 8 devices. If a new device is paired after 8 devices are already paired, the registration information of the paired device with the oldest connection date is overwritten with the information for the new device.
 - When the pairing information for the headset has been deleted from the Bluetooth device.
 - When the headset is initialized.
All of the pairing information is deleted. In this case, delete the pairing information for the headset from the device and then pair them again.
- The headset can be paired with multiple devices, but can only play music from 1 paired device at a time.

Related Topic

- [How to make a wireless connection to Bluetooth devices](#)
- [Connecting to a paired iPhone](#)
- [Listening to music from a device via Bluetooth connection](#)
- [Disconnecting Bluetooth connection \(after use\)](#)

- [Initializing the headset to restore factory settings](#)

5-013-731-11(4) Copyright 2020 Sony Corporation

Connecting to a paired iPhone

1 Unlock the screen of the iPhone if it is locked.

2 Turn on the headset.

Press and hold the  (power) button for about 2 seconds.



You will hear the voice guidance say, "Power on". Check that the indicator (blue) continues to flash after you release your finger from the button.

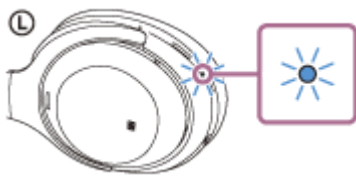

If the headset has automatically connected to the last connected device, you will hear the voice guidance say, "Bluetooth connected".

Check the connection status on the iPhone. If it is not connected, proceed to step 3.

3 Display the devices paired with the iPhone.

1. Select [Settings].
2. Touch [Bluetooth].

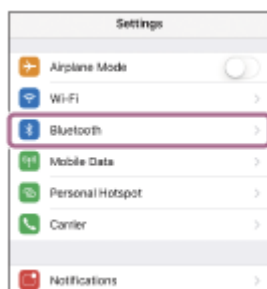

3. Touch the switch to turn on the Bluetooth function.

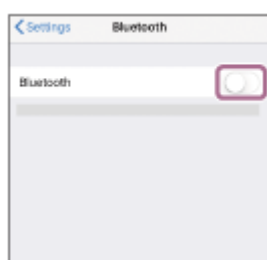

4 Touch [WH-1000XM4].

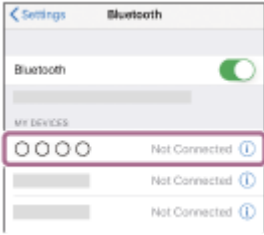

You will hear the voice guidance say, “Bluetooth connected”.

Hint

- The operation above is an example. For more details, refer to the operating instructions supplied with your iPhone.

Note

- When connecting, if [WH-1000XM4] and [LE_WH-1000XM4] are displayed, select [WH-1000XM4]. [LE_WH-1000XM4] will be displayed first, but wait until [WH-1000XM4] is displayed. It may take about 30 seconds to 1 minute for [WH-1000XM4] to be displayed. If [WH-1000XM4] is not displayed, perform the pairing again.
- If the last-connected Bluetooth device is placed near the headset, the headset may connect automatically to the device by simply turning on the headset. In that case, deactivate the Bluetooth function on the last-connected device or turn off the power.
- If you cannot connect your iPhone to the headset, delete the headset pairing information on your iPhone and perform the pairing again. As for the operations on your iPhone, refer to the operating instructions supplied with the iPhone.

Related Topic

- [How to make a wireless connection to Bluetooth devices](#)
- [Pairing and connecting with an iPhone](#)
- [Listening to music from a device via Bluetooth connection](#)
- [Disconnecting Bluetooth connection \(after use\)](#)

Wireless Noise Canceling Stereo Headset
WH-1000XM4

Pairing and connecting with a computer (Windows 10)

The operation to register the device that you wish to connect to is called “pairing”. First, pair a device to use it with the headset for the first time.

Before starting the operation, make sure of the following:

- Your computer has a Bluetooth function that supports music playback connections (A2DP).
- When you use a video calling application on your computer, your computer has a Bluetooth function that supports calling connections (HFP/HSP).
- The computer is placed within 1 m (3 feet) of the headset.
- The headset is charged sufficiently.
- The operating instructions of the computer is in hand.
- Depending on the computer you are using, the built-in Bluetooth adaptor may need to be turned on. If you do not know how to turn on the Bluetooth adaptor or are unsure if your computer has a built-in Bluetooth adaptor, refer to the operating instructions supplied with the computer.

1 Enter pairing mode on this headset.

Turn on the headset when you pair the headset with a device for the first time after you bought it or after you initialized the headset (the headset has no pairing information). The headset enters pairing mode automatically. In this case, proceed to step **2**.

When you pair a second or subsequent device (the headset has pairing information for other devices), press and hold the  (power) button for about 7 seconds.



Check that the indicator (blue) repeatedly flashes twice in a row. You will hear the voice guidance say, “Bluetooth pairing”.

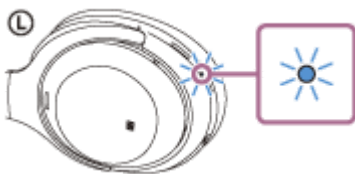

2 Wake the computer up if the computer is in standby (sleep) or hibernation mode.

3 Register the headset using the computer.

1. Click the [Start] button, then [Settings].
2. Click [Devices].

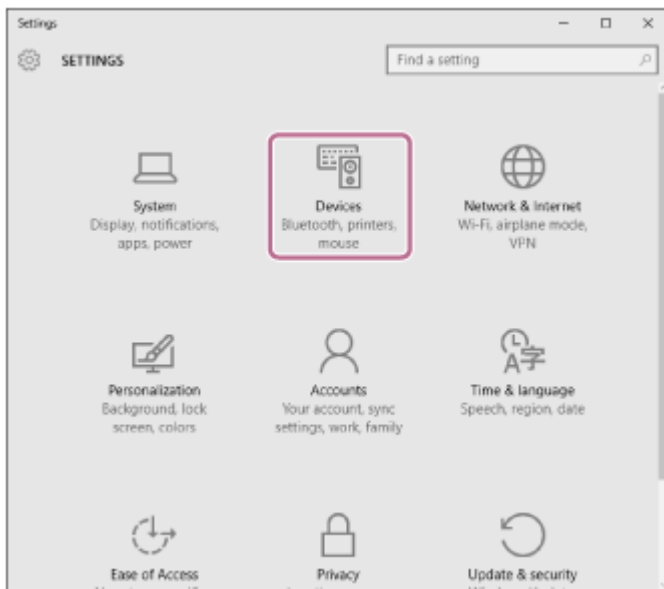

3. Click the [Bluetooth] tab, click the [Bluetooth] switch to turn on the Bluetooth function, then select [WH-1000XM4].

If [WH-1000XM4] and [LE_WH-1000XM4] are displayed, select [WH-1000XM4].

[LE_WH-1000XM4] will be displayed first, but wait until [WH-1000XM4] is displayed.

It may take about 30 seconds to 1 minute for [WH-1000XM4] to be displayed.

If [WH-1000XM4] is not displayed, try again from step ❶ .

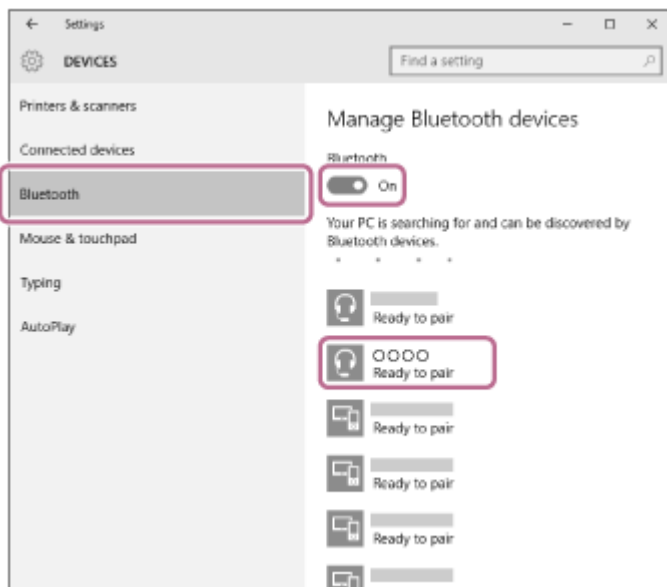

4. Click [Pair].

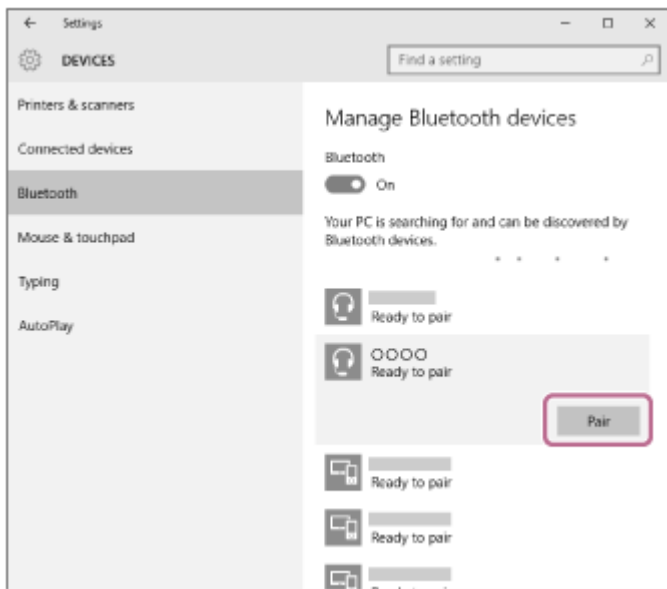

If Passkey (*) input is required, input "0000".

The headset and computer are paired and connected with each other. You will hear the voice guidance say, "Bluetooth connected".

If they are not connected, see "[Connecting to a paired computer \(Windows 10\)](#)".

* A Passkey may be called "Passcode", "PIN code", "PIN number", or "Password".

Hint

- The operation above is an example. For more details, refer to the operating instructions supplied with the computer.
- To delete all Bluetooth pairing information, see "[Initializing the headset to restore factory settings](#)".

Note

- If pairing is not established within 5 minutes, pairing mode is canceled. In this case, start the operation again from step ①.
- Once Bluetooth devices are paired, there is no need to pair them again, except in the following cases:
 - Pairing information has been deleted after repair, etc.
 - When a 9th device is paired.
The headset can be paired with up to 8 devices. If a new device is paired after 8 devices are already paired, the registration information of the paired device with the oldest connection date is overwritten with the information for the new device.
 - When the pairing information for the headset has been deleted from the Bluetooth device.
 - When the headset is initialized.
All of the pairing information is deleted. In this case, delete the pairing information for the headset from the device and then pair them again.
- The headset can be paired with multiple devices, but can only play music from 1 paired device at a time.

Related Topic

- [How to make a wireless connection to Bluetooth devices](#)
- [Connecting to a paired computer \(Windows 10\)](#)
- [Listening to music from a device via Bluetooth connection](#)
- [Making a video call on a computer](#)
- [Disconnecting Bluetooth connection \(after use\)](#)
- [Initializing the headset to restore factory settings](#)

Pairing and connecting with a computer (Windows 8.1)

The operation to register the device that you wish to connect to is called “pairing”. First, pair a device to use it with the headset for the first time.

Before starting the operation, make sure of the following:

- Your computer has a Bluetooth function that supports music playback connections (A2DP).
- When you use a video calling application on your computer, your computer has a Bluetooth function that supports calling connections (HFP/HSP).
- The computer is placed within 1 m (3 feet) of the headset.
- The headset is charged sufficiently.
- The operating instructions of the computer is in hand.
- Depending on the computer you are using, the built-in Bluetooth adaptor may need to be turned on. If you do not know how to turn on the Bluetooth adaptor or are unsure if your computer has a built-in Bluetooth adaptor, refer to the operating instructions supplied with the computer.

1 Enter pairing mode on this headset.

Turn on the headset when you pair the headset with a device for the first time after you bought it or after you initialized the headset (the headset has no pairing information). The headset enters pairing mode automatically. In this case, proceed to step 2 .

When you pair a second or subsequent device (the headset has pairing information for other devices), press and hold the  (power) button for about 7 seconds.



Check that the indicator (blue) repeatedly flashes twice in a row. You will hear the voice guidance say, “Bluetooth pairing”.

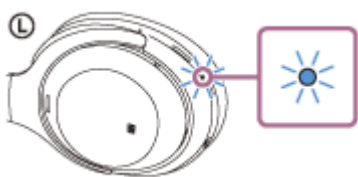

2 Wake the computer up if the computer is in standby (sleep) or hibernation mode.

3 Register the headset using the computer.

1. Move the mouse pointer to the top-right corner of the screen (when using a touch panel, swipe from the right edge of the screen), then select [Settings] from the Charm Bar.

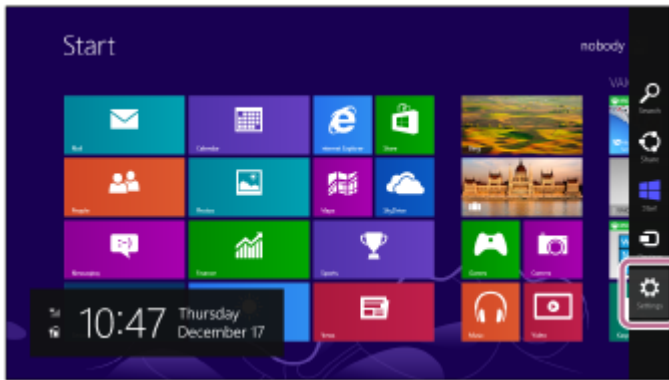

2. Select [Change PC Settings] of the [Settings] charm.

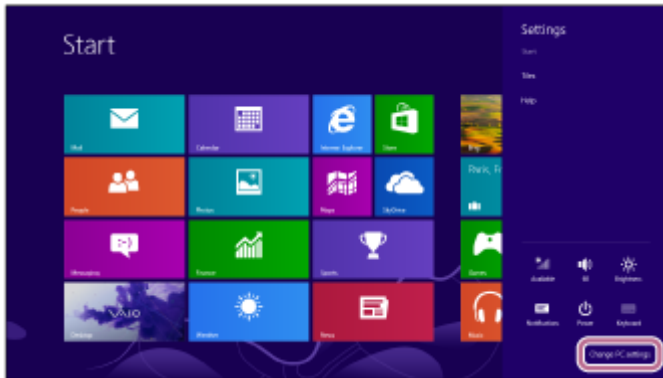

3. Select [PC and devices] of the [PC Settings] screen.

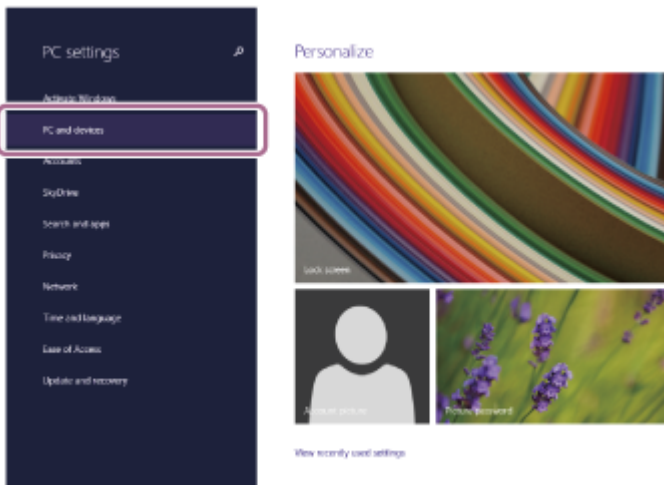

4. Select [Bluetooth].

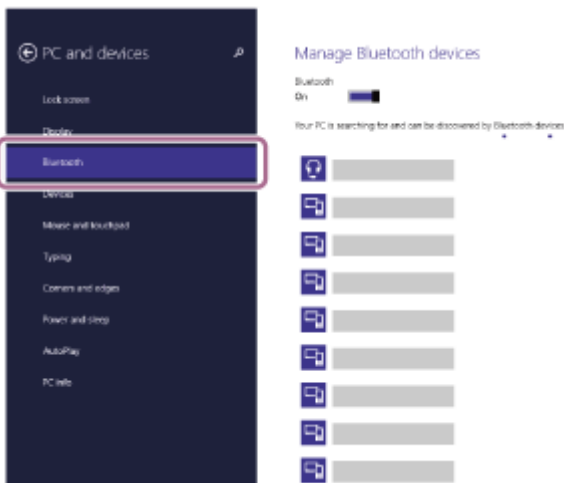

5. Select [WH-1000XM4], then select [Pair].
If [WH-1000XM4] and [LE_WH-1000XM4] are displayed, select [WH-1000XM4].

[LE_WH-1000XM4] will be displayed first, but wait until [WH-1000XM4] is displayed. It may take about 30 seconds to 1 minute for [WH-1000XM4] to be displayed. If [WH-1000XM4] is not displayed, try again from step ① .

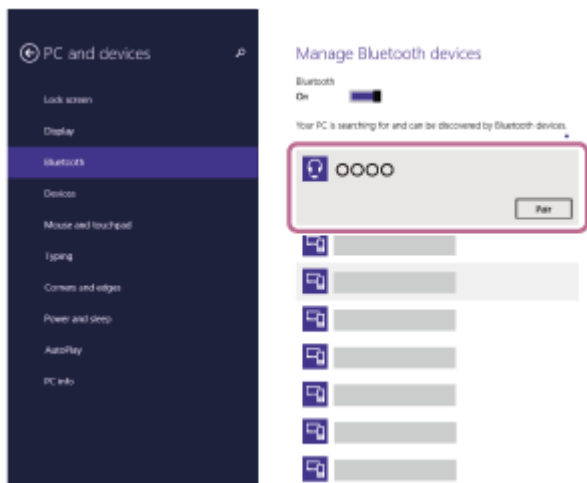

If Passkey (*) input is required, input “0000”.

The headset and computer are paired and connected with each other. You will hear the voice guidance say, “Bluetooth connected”.

If they are not connected, see [“Connecting to a paired computer \(Windows 8.1\)”](#).

* A Passkey may be called “Passcode”, “PIN code”, “PIN number”, or “Password”.

Hint

- The operation above is an example. For more details, refer to the operating instructions supplied with the computer.
- To delete all Bluetooth pairing information, see [“Initializing the headset to restore factory settings”](#).

Note

- If pairing is not established within 5 minutes, pairing mode is canceled. In this case, start the operation again from step ① .
- Once Bluetooth devices are paired, there is no need to pair them again, except in the following cases:
 - Pairing information has been deleted after repair, etc.
 - When a 9th device is paired.
The headset can be paired with up to 8 devices. If a new device is paired after 8 devices are already paired, the registration information of the paired device with the oldest connection date is overwritten with the information for the new device.
 - When the pairing information for the headset has been deleted from the Bluetooth device.
 - When the headset is initialized.
All of the pairing information is deleted. In this case, delete the pairing information for the headset from the device and then pair them again.
- The headset can be paired with multiple devices, but can only play music from 1 paired device at a time.

Related Topic

- [How to make a wireless connection to Bluetooth devices](#)
- [Connecting to a paired computer \(Windows 8.1\)](#)
- [Listening to music from a device via Bluetooth connection](#)
- [Making a video call on a computer](#)
- [Disconnecting Bluetooth connection \(after use\)](#)
- [Initializing the headset to restore factory settings](#)

Wireless Noise Canceling Stereo Headset
WH-1000XM4

Pairing and connecting with a computer (Mac)

The operation to register the device that you wish to connect to is called “pairing”. First, pair a device to use it with the headset for the first time.

Compatible OS

macOS (version 10.10 or later)

Before starting the operation, make sure of the following:

- Your computer has a Bluetooth function that supports music playback connections (A2DP).
- When you use a video calling application on your computer, your computer has a Bluetooth function that supports calling connections (HFP/HSP).
- The computer is placed within 1 m (3 feet) of the headset.
- The headset is charged sufficiently.
- The operating instructions of the computer is in hand.
- Depending on the computer you are using, the built-in Bluetooth adaptor may need to be turned on. If you do not know how to turn on the Bluetooth adaptor or are unsure if your computer has a built-in Bluetooth adaptor, refer to the operating instructions supplied with the computer.
- Set the computer speaker to the ON mode.

If the computer speaker is set to the  “OFF” mode, no sound is heard from the headset.

Computer speaker in the ON mode



1 Enter pairing mode on this headset.

Turn on the headset when you pair the headset with a device for the first time after you bought it or after you initialized the headset (the headset has no pairing information). The headset enters pairing mode automatically. In this case, proceed to step **2**.

When you pair a second or subsequent device (the headset has pairing information for other devices), press and hold the  (power) button for about 7 seconds.



Check that the indicator (blue) repeatedly flashes twice in a row. You will hear the voice guidance say, “Bluetooth pairing”.

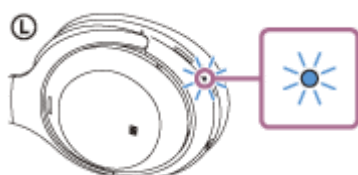

2 Wake the computer up if the computer is in standby (sleep) or hibernation mode.

3 Register the headset using the computer.

1. Select [ (System Preferences)] - [Bluetooth] from the task bar in the lower right part of the screen.



2. Select [WH-1000XM4] of the [Bluetooth] screen and click [Connect].
If [WH-1000XM4] and [LE_WH-1000XM4] are displayed, select [WH-1000XM4].
[LE_WH-1000XM4] will be displayed first, but wait until [WH-1000XM4] is displayed.
It may take about 30 seconds to 1 minute for [WH-1000XM4] to be displayed.
If [WH-1000XM4] is not displayed, try again from step 1 .

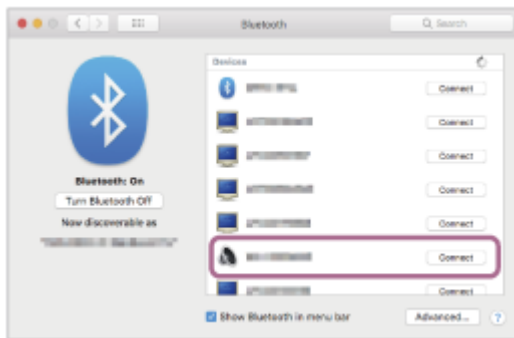

If Passkey (*) input is required, input "0000".

The headset and computer are paired and connected with each other. You will hear the voice guidance say, "Bluetooth connected".

If they are not connected, see "[Connecting to a paired computer \(Mac\)](#)".

* A Passkey may be called "Passcode", "PIN code", "PIN number", or "Password".

4 Click the speaker icon in the upper right part of the screen and select [WH-1000XM4].

Now you are ready to enjoy music playback on your computer.

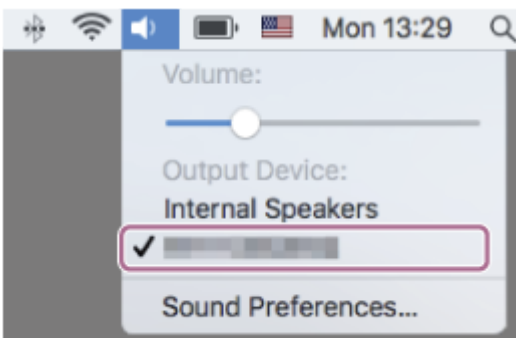

Hint

- The operation above is an example. For more details, refer to the operating instructions supplied with the computer.
- To delete all Bluetooth pairing information, see [“Initializing the headset to restore factory settings”](#).

Note

- If pairing is not established within 5 minutes, pairing mode is canceled. In this case, start the operation again from step ① .
- Once Bluetooth devices are paired, there is no need to pair them again, except in the following cases:
 - Pairing information has been deleted after repair, etc.
 - When a 9th device is paired.
The headset can be paired with up to 8 devices. If a new device is paired after 8 devices are already paired, the registration information of the paired device with the oldest connection date is overwritten with the information for the new device.
 - When the pairing information for the headset has been deleted from the Bluetooth device.
 - When the headset is initialized.
All of the pairing information is deleted. In this case, delete the pairing information for the headset from the device and then pair them again.
- The headset can be paired with multiple devices, but can only play music from 1 paired device at a time.

Related Topic

- [How to make a wireless connection to Bluetooth devices](#)
- [Connecting to a paired computer \(Mac\)](#)
- [Listening to music from a device via Bluetooth connection](#)
- [Making a video call on a computer](#)
- [Disconnecting Bluetooth connection \(after use\)](#)
- [Initializing the headset to restore factory settings](#)

Connecting to a paired computer (Windows 10)

Before starting the operation, make sure of the following:

- Depending on the computer you are using, the built-in Bluetooth adaptor may need to be turned on. If you do not know how to turn on the Bluetooth adaptor or are unsure if your computer has a built-in Bluetooth adaptor, refer to the operating instructions supplied with the computer.

1 Wake the computer up if the computer is in standby (sleep) or hibernation mode.

2 Turn on the headset.

Press and hold the  (power) button for about 2 seconds.



You will hear the voice guidance say, "Power on". Check that the indicator (blue) continues to flash after you release your finger from the button.

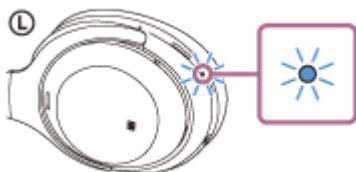

If the headset has automatically connected to the last connected device, you will hear the voice guidance say, "Bluetooth connected".

Check the connection status on the computer. If it is not connected, proceed to step 3.

3 Select the headset using the computer.

1. Right-click the speaker icon on the toolbar, then select [Playback devices].

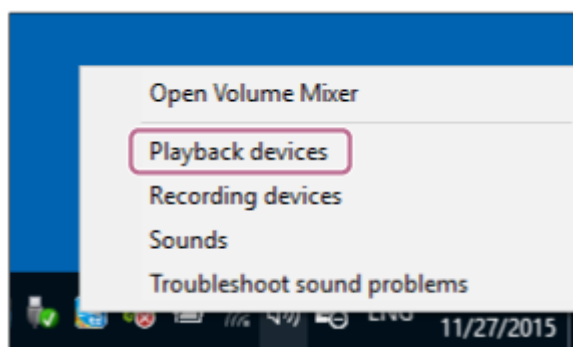

2. Right-click [WH-1000XM4].
If [WH-1000XM4] is not displayed on the [Sound] screen, right-click on the [Sound] screen, then check [Show Disconnected Devices].

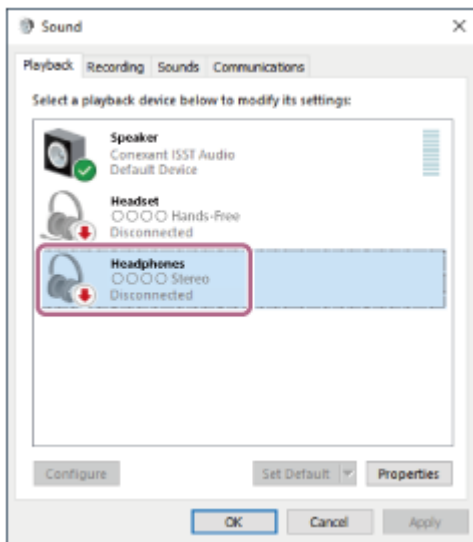

3. Select [Connect] from the displayed menu.

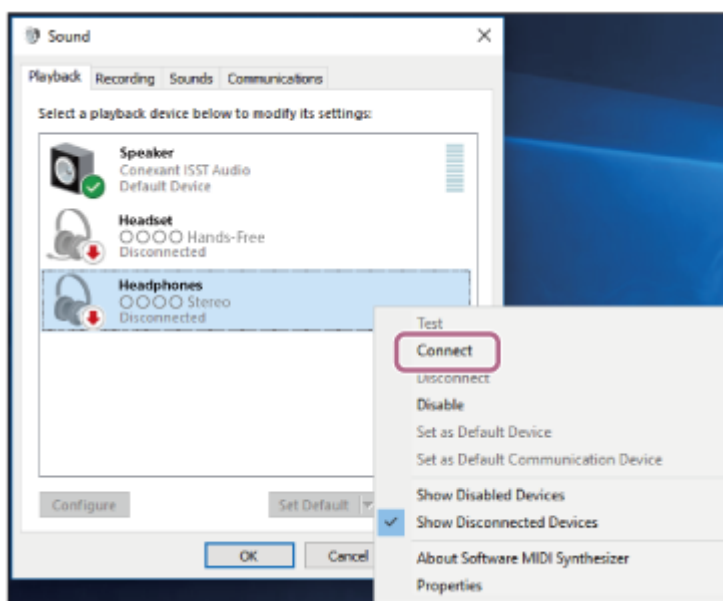

The connection is established. You will hear the voice guidance say, "Bluetooth connected".

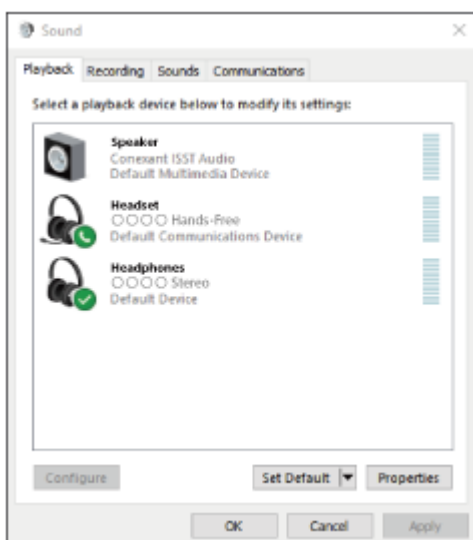

Hint

- The operation above is an example. For more details, refer to the operating instructions supplied with the computer.

Note

- When connecting, if [WH-1000XM4] and [LE_WH-1000XM4] are displayed, select [WH-1000XM4]. [LE_WH-1000XM4] will be displayed first, but wait until [WH-1000XM4] is displayed. It may take about 30 seconds to 1 minute for [WH-1000XM4] to be displayed. If [WH-1000XM4] is not displayed, perform the pairing again.
- If the music playback sound quality is poor, check that the A2DP function which supports music playback connections is enabled in the computer settings. For more details, refer to the operating instructions supplied with the computer.
- If the last-connected Bluetooth device is placed near the headset, the headset may connect automatically to the device by simply turning on the headset. In that case, deactivate the Bluetooth function on the last-connected device or turn off the power.
- If you cannot connect your computer to the headset, delete the headset pairing information on your computer and perform the pairing again. As for the operations on your computer, refer to the operating instructions supplied with the computer.

Related Topic

- [How to make a wireless connection to Bluetooth devices](#)
- [Pairing and connecting with a computer \(Windows 10\)](#)
- [Listening to music from a device via Bluetooth connection](#)
- [Disconnecting Bluetooth connection \(after use\)](#)

Wireless Noise Canceling Stereo Headset
WH-1000XM4

Connecting to a paired computer (Windows 8.1)

Before starting the operation, make sure of the following:

- Depending on the computer you are using, the built-in Bluetooth adaptor may need to be turned on. If you do not know how to turn on the Bluetooth adaptor or are unsure if your computer has a built-in Bluetooth adaptor, refer to the operating instructions supplied with the computer.

1 Wake the computer up if the computer is in standby (sleep) or hibernation mode.

2 Turn on the headset.

Press and hold the  (power) button for about 2 seconds.



You will hear the voice guidance say, "Power on". Check that the indicator (blue) continues to flash after you release your finger from the button.

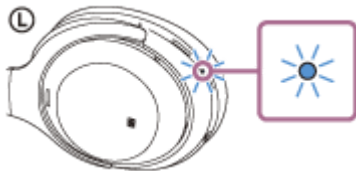

If the headset has automatically connected to the last connected device, you will hear the voice guidance say, "Bluetooth connected".

Check the connection status on the computer. If it is not connected, proceed to step 3.

3 Select the headset using the computer.

1. Select [Desktop] on the Start screen.
2. Right-click the [Start] button, then select [Control Panel] from the pop-up menu.
3. Select [Hardware and Sound] - [Sound].

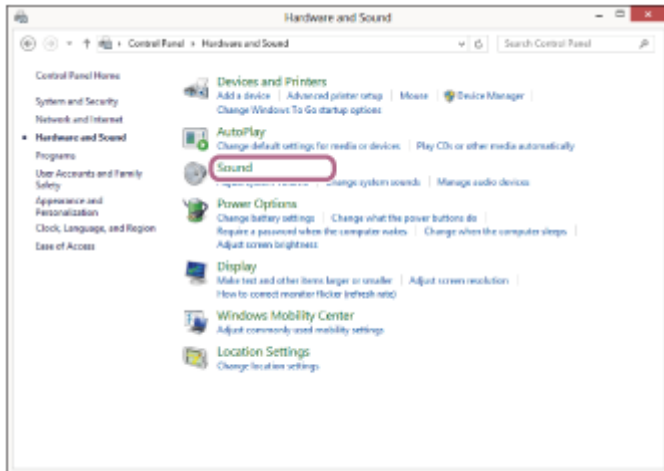
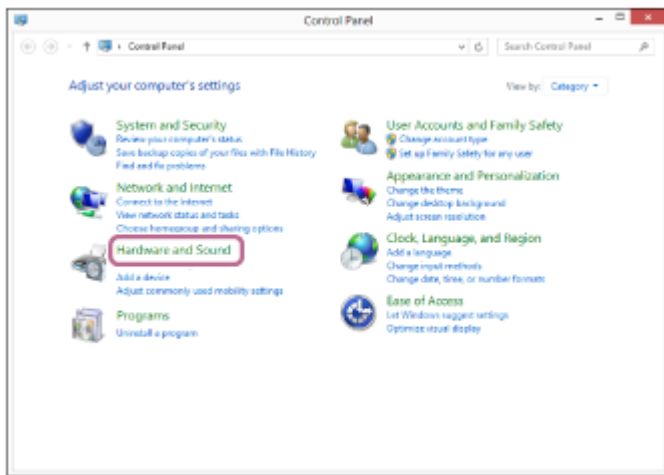

4. Right-click [WH-1000XM4].
If [WH-1000XM4] is not displayed on the [Sound] screen, right-click on the [Sound] screen, then check [Show Disconnected Devices].

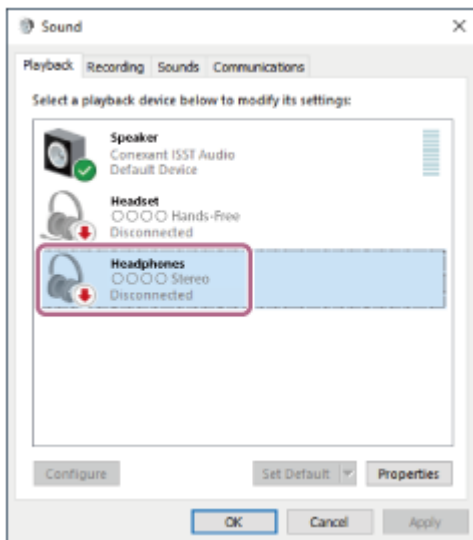

5. Select [Connect] from the displayed menu.

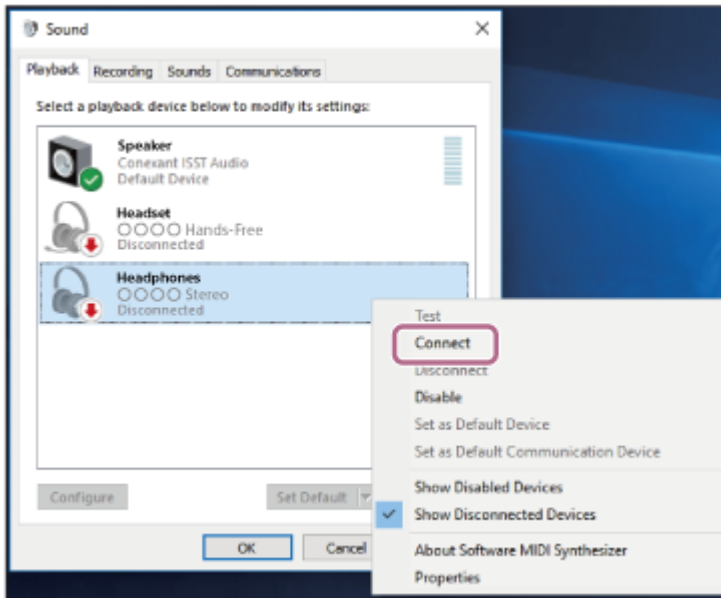

The connection is established. You will hear the voice guidance say, “Bluetooth connected”.

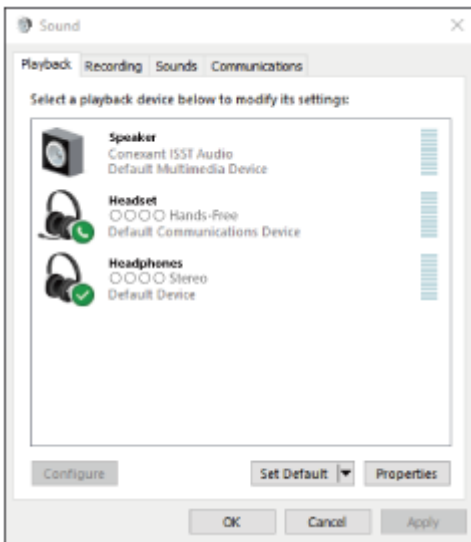

Hint

- The operation above is an example. For more details, refer to the operating instructions supplied with the computer.

Note

- When connecting, if [WH-1000XM4] and [LE_WH-1000XM4] are displayed, select [WH-1000XM4]. [LE_WH-1000XM4] will be displayed first, but wait until [WH-1000XM4] is displayed. It may take about 30 seconds to 1 minute for [WH-1000XM4] to be displayed. If [WH-1000XM4] is not displayed, perform the pairing again.
- If the music playback sound quality is poor, check that the A2DP function which supports music playback connections is enabled in the computer settings. For more details, refer to the operating instructions supplied with the computer.
- If the last-connected Bluetooth device is placed near the headset, the headset may connect automatically to the device by simply turning on the headset. In that case, deactivate the Bluetooth function on the last-connected device or turn off the power.
- If you cannot connect your computer to the headset, delete the headset pairing information on your computer and perform the pairing again. As for the operations on your computer, refer to the operating instructions supplied with the computer.

- [How to make a wireless connection to Bluetooth devices](#)
- [Pairing and connecting with a computer \(Windows 8.1\)](#)
- [Listening to music from a device via Bluetooth connection](#)
- [Disconnecting Bluetooth connection \(after use\)](#)

5-013-731-11(4) Copyright 2020 Sony Corporation

Connecting to a paired computer (Mac)

Compatible OS

macOS (version 10.10 or later)

Before starting the operation, make sure of the following:

- Depending on the computer you are using, the built-in Bluetooth adaptor may need to be turned on. If you do not know how to turn on the Bluetooth adaptor or are unsure if your computer has a built-in Bluetooth adaptor, refer to the operating instructions supplied with the computer.
- Set the computer speaker to the ON mode.

If the computer speaker is set to the  "OFF" mode, no sound is heard from the headset.

Computer speaker in the ON mode



1 Wake the computer up if the computer is in standby (sleep) or hibernation mode.

2 Turn on the headset.

Press and hold the  (power) button for about 2 seconds.



You will hear the voice guidance say, "Power on". Check that the indicator (blue) continues to flash after you release your finger from the button.

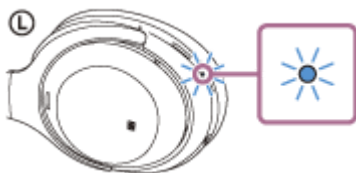

If the headset has automatically connected to the last connected device, you will hear the voice guidance say, "Bluetooth connected".

Check the connection status on the computer. If it is not connected, proceed to step 3.

3 Select the headset using the computer.

1. Select [ (System Preferences)] - [Bluetooth] from the task bar in the lower right part of the screen.



2. Click [WH-1000XM4] on the [Bluetooth] screen while pressing the computer Control button and select [Connect] from the pop up menu.



You will hear the voice guidance say, “Bluetooth connected”.

4. Click the speaker icon in the upper right part of the screen and select [WH-1000XM4].

Now you are ready to enjoy music playback on your computer.

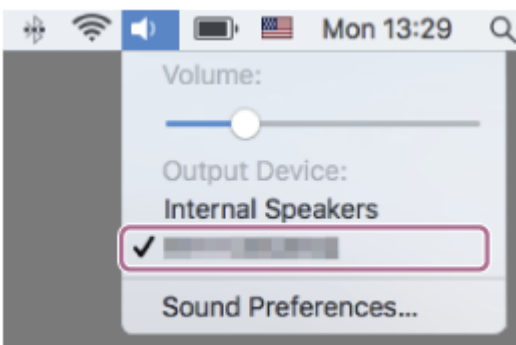

Hint

- The operation above is an example. For more details, refer to the operating instructions supplied with the computer.

Note

- When connecting, if [WH-1000XM4] and [LE_WH-1000XM4] are displayed, select [WH-1000XM4]. [LE_WH-1000XM4] will be displayed first, but wait until [WH-1000XM4] is displayed. It may take about 30 seconds to 1 minute for [WH-1000XM4] to be displayed. If [WH-1000XM4] is not displayed, perform the pairing again.

- If the music playback sound quality is poor, check that the A2DP function which supports music playback connections is enabled in the computer settings. For more details, refer to the operating instructions supplied with the computer.
- If the last-connected Bluetooth device is placed near the headset, the headset may connect automatically to the device by simply turning on the headset. In that case, deactivate the Bluetooth function on the last-connected device or turn off the power.
- If you cannot connect your computer to the headset, delete the headset pairing information on your computer and perform the pairing again. As for the operations on your computer, refer to the operating instructions supplied with the computer.

Related Topic

- [How to make a wireless connection to Bluetooth devices](#)
- [Pairing and connecting with a computer \(Mac\)](#)
- [Listening to music from a device via Bluetooth connection](#)
- [Disconnecting Bluetooth connection \(after use\)](#)

Wireless Noise Canceling Stereo Headset
WH-1000XM4

Pairing and connecting with a Bluetooth device

The operation to register the device that you wish to connect to is called “pairing”. First, pair a device to use it with the headset for the first time.

Before starting the operation, make sure of the following:

- The Bluetooth device is placed within 1 m (3 feet) of the headset.
- The headset is charged sufficiently.
- The operating instructions of the Bluetooth device is in hand.

1 Enter pairing mode on this headset.

Turn on the headset when you pair the headset with a device for the first time after you bought it or after you initialized the headset (the headset has no pairing information). The headset enters pairing mode automatically. In this case, proceed to step 2.

When you pair a second or subsequent device (the headset has pairing information for other devices), press and hold the  (power) button for about 7 seconds.



Check that the indicator (blue) repeatedly flashes twice in a row. You will hear the voice guidance say, “Bluetooth pairing”.

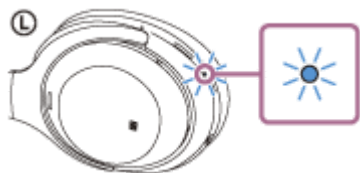

2 Perform the pairing procedure on the Bluetooth device to search for this headset.

[WH-1000XM4] will be displayed on the list of detected devices on the screen of the Bluetooth device.

If [WH-1000XM4] and [LE_WH-1000XM4] are displayed, select [WH-1000XM4].

[LE_WH-1000XM4] will be displayed first, but wait until [WH-1000XM4] is displayed.

It may take about 30 seconds to 1 minute for [WH-1000XM4] to be displayed.

If [WH-1000XM4] is not displayed, try again from step 1.

3 Select [WH-1000XM4] displayed on the screen of the Bluetooth device for pairing.

If Passkey (*) input is required, input “0000”.

* A Passkey may be called “Passcode”, “PIN code”, “PIN number”, or “Password”.

4 Make the Bluetooth connection from the Bluetooth device.

Some devices automatically connect with the headset when the pairing is complete. You will hear the voice guidance say, “Bluetooth connected”.

Hint

- The operation above is an example. For more details, refer to the operating instructions supplied with the Bluetooth device.
- To delete all Bluetooth pairing information, see [“Initializing the headset to restore factory settings”](#).

Note

- If pairing is not established within 5 minutes, pairing mode is canceled. In this case, start the operation again from step 1.
- Once Bluetooth devices are paired, there is no need to pair them again, except in the following cases:
 - Pairing information has been deleted after repair, etc.
 - When a 9th device is paired.
The headset can be paired with up to 8 devices. If a new device is paired after 8 devices are already paired, the registration information of the paired device with the oldest connection date is overwritten with the information for the new device.
 - When the pairing information for the headset has been deleted from the Bluetooth device.
 - When the headset is initialized.
All of the pairing information is deleted. In this case, delete the pairing information for the headset from the device and then pair them again.
- The headset can be paired with multiple devices, but can only play music from 1 paired device at a time.

Related Topic

- [How to make a wireless connection to Bluetooth devices](#)
- [Connecting to a paired Bluetooth device](#)
- [Listening to music from a device via Bluetooth connection](#)
- [Disconnecting Bluetooth connection \(after use\)](#)
- [Initializing the headset to restore factory settings](#)

Connecting to a paired Bluetooth device

1 Turn on the headset.

Press and hold the  (power) button for about 2 seconds.



You will hear the voice guidance say, "Power on". Check that the indicator (blue) continues to flash after you release your finger from the button.

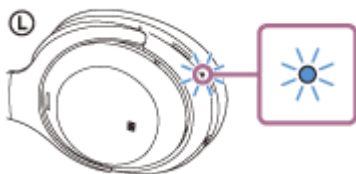

If the headset has automatically connected to the last connected device, you will hear the voice guidance say, "Bluetooth connected".

Check the connection status on the Bluetooth device. If it is not connected, proceed to step 2.

2 Make the Bluetooth connection from the Bluetooth device.

As for the operations on your Bluetooth device, refer to the operating instructions supplied with the Bluetooth device. When connected, you will hear the voice guidance say, "Bluetooth connected".

Hint

- The operation above is an example. For more details, refer to the operating instructions supplied with the Bluetooth device.

Note

- When connecting, if [WH-1000XM4] and [LE_WH-1000XM4] are displayed, select [WH-1000XM4]. [LE_WH-1000XM4] will be displayed first, but wait until [WH-1000XM4] is displayed. It may take about 30 seconds to 1 minute for [WH-1000XM4] to be displayed. If [WH-1000XM4] is not displayed, perform the pairing again.
- If the last-connected Bluetooth device is placed near the headset, the headset may connect automatically to the device by simply turning on the headset. In that case, deactivate the Bluetooth function on the last-connected device or turn off the power.
- If you cannot connect your Bluetooth device to the headset, delete the headset pairing information on your Bluetooth device and perform the pairing again. As for the operations on your Bluetooth device, refer to the operating instructions supplied with the Bluetooth device.

- [How to make a wireless connection to Bluetooth devices](#)
- [Pairing and connecting with a Bluetooth device](#)
- [Listening to music from a device via Bluetooth connection](#)
- [Disconnecting Bluetooth connection \(after use\)](#)

5-013-731-11(4) Copyright 2020 Sony Corporation

Wireless Noise Canceling Stereo Headset
WH-1000XM4

Connecting the headset to both a music player and a smartphone / mobile phone (multipoint connection)

Multipoint is a function which allows you to connect 2 Bluetooth devices to the headset and use one device for music playback (A2DP connection) and the other for calls (HFP/HSP connection).

When you wish to use a music player only for music playback and a smartphone only for calls, use a multipoint connection to the headset for each device. The connecting devices need to support the Bluetooth function.

1 Pair the headset with both the music player and the smartphone/mobile phone.

2 Connect the headset with the music player.

Operate the music player to establish a Bluetooth connection with the headset.

3 Connect the headset to the smartphone/mobile phone.

Operate the smartphone/mobile phone to establish a Bluetooth connection with the headset.

Note

- If the smartphone or mobile phone was connected with the headset last time, an HFP or HSP connection is automatically established when the headset is turned on, and in some cases an A2DP connection is simultaneously established. In that case, connect from step 2 after disconnecting via smartphone/mobile phone operations.

Wireless Noise Canceling Stereo Headset
WH-1000XM4

Connecting the headset to 2 Android smartphones (multipoint connection)

Usually, when you connect the headset to a smartphone, both the music playback function and the phone call function are connected simultaneously.

To make a multipoint connection using 2 smartphones to use one for listening to music and the other for making phone calls, set up to connect to only one function by operating the smartphone.

- 1 Pair the headset with both smartphones, respectively.
- 2 Operate one of the smartphones to establish a Bluetooth connection with the headset.
- 3 Operate the smartphone connected to the headset, uncheck either [Call audio] (HFP) or [Media audio] (A2DP).

Operation example: For connecting only through media audio (A2DP)

Touch [Settings] - [Device connection] - [Bluetooth] - the setting icon next to [WH-1000XM4].

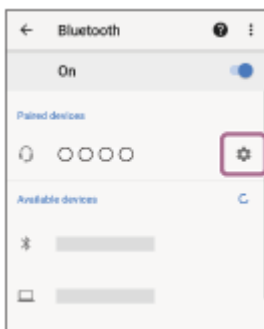

On the [Paired devices] screen, uncheck [Call audio].

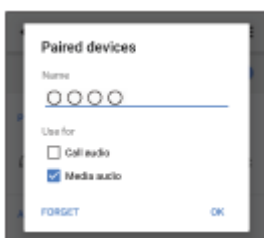

- 4 Operate the smartphone to terminate the Bluetooth connection.
- 5 Operate the other smartphone to establish a Bluetooth connection with the headset.
- 6 In the same way, uncheck the function that you did not uncheck in step 3.
- 7 Operate the first smartphone to establish a Bluetooth connection with the headset.

Both smartphones are connected to the headset with only one function enabled.

Hint

- The operation above is an example. For more details, refer to the operating instructions supplied with the Android smartphone.

Note

- When using multipoint connection, the remaining battery charge of the headset will not be correctly displayed on the screen of the device that is connected for listening to music (A2DP).

Related Topic

- [Checking the remaining battery charge](#)

5-013-731-11(4) Copyright 2020 Sony Corporation

Wireless Noise Canceling Stereo Headset
WH-1000XM4

Connecting the headset to an Android smartphone and an iPhone (multipoint connection)

Usually, when you connect the headset to a smartphone, both the music playback function and the phone call function are connected simultaneously.

To make a multipoint connection using a smartphone and an iPhone to use one for listening to music and the other for making phone calls, change the settings on the smartphone so that only one of the functions is connected. Connect the smartphone before connecting the iPhone.

You cannot set the iPhone to connect one function only.

- 1 Pair the headset with both the smartphone and the iPhone, respectively.
- 2 Operate the smartphone to establish a Bluetooth connection with the headset.
- 3 Operate the smartphone connected to the headset, uncheck either [Call audio] (HFP) or [Media audio] (A2DP).

Operation example: For connecting only through media audio (A2DP)

Touch [Settings] - [Device connection] - [Bluetooth] - the setting icon next to [WH-1000XM4].

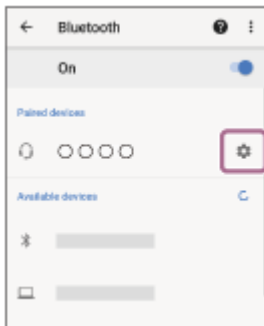

On the [Paired devices] screen, uncheck [Call audio].



- 4 Operate the iPhone to establish a Bluetooth connection with the headset.

The iPhone is connected with the function unchecked in step 3.

Hint

- The operation above is an example. For more details, refer to the operating instructions supplied with the Android smartphone and iPhone.

Note

- When using multipoint connection, the remaining battery charge of the headset will not be correctly displayed on the screen of the device that is connected for listening to music (A2DP).

Related Topic

- [Checking the remaining battery charge](#)

5-013-731-11(4) Copyright 2020 Sony Corporation

Wireless Noise Canceling Stereo Headset
WH-1000XM4

Connecting the headset to 2 devices simultaneously (multipoint connection)

When [Connect to 2 devices simultaneously] is turned on with the “Sony | Headphones Connect” app, the headset can connect to 2 devices via Bluetooth connections simultaneously, allowing you to do the following.

- Waiting for an incoming call for 2 smartphones
You can listen to music played on one smartphone with the headset, wait for an incoming call for both smartphones, and talk if an incoming call arrives.

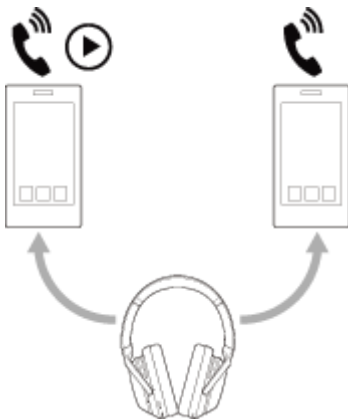

- Switching music playback between 2 devices
You can switch the music playback from one device to the other without performing a Bluetooth reconnection.

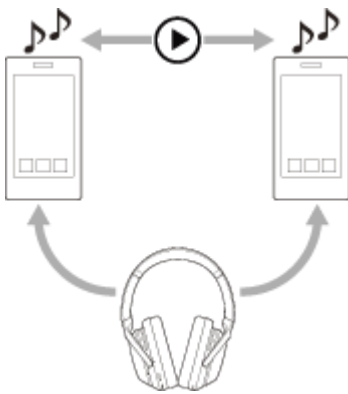

Connecting the headset to 2 devices via Bluetooth connections simultaneously

Before connecting, make sure that the “Sony | Headphones Connect” app is installed on one of the 2 devices.

- 1 Pair the headset with 2 devices, respectively.
- 2 Operate the device on which the “Sony | Headphones Connect” app is installed to establish a Bluetooth connection with the headset.
- 3 Turn on [Connect to 2 devices simultaneously] with the “Sony | Headphones Connect” app.
- 4 Operate the second device to establish a Bluetooth connection with the headset.

When Bluetooth connections are established between 2 devices and the headset, another paired device can be connected via Bluetooth connection.

If you try to make a Bluetooth connection with the headset by operating the third device, the Bluetooth connection with the last device that played music will be maintained, and the Bluetooth connection with the other device will be disconnected. Then a Bluetooth connection between the third device and the headset is established.

Music playback when the headset is connected to 2 devices via Bluetooth connections

- When playing music by operating the headset, the music is played from the device that played last.
- If you want to play music from the other device, stop playback on the device that is playing the music, and start playback by operating the other device.
Even if you start playback by operating the second device while playing music on the first device, the music from the first device will continue to be heard via the headset. In this state, if you stop playback on the first device, you can listen to music from the second device via the headset.

Talking on the phone when the headset is connected to 2 devices via Bluetooth connections

- When the headset is connected to 2 smartphones, etc. via Bluetooth connections simultaneously, both devices will be in standby mode.
- When an incoming call arrives to the first device, a ring tone is heard via the headset. When an incoming call arrives to the second device while talking on the headset, a ring tone is heard via the second device.
If you finish the call on the first device, the ring tone from the second device will be heard via the headset.

Note

- When [Connect to 2 devices simultaneously] is turned on with the “Sony | Headphones Connect” app, LDAC cannot be used. The codec is automatically switched to AAC or SBC.

Related Topic

- [What you can do with the “Sony | Headphones Connect” app](#)
- [How to make a wireless connection to Bluetooth devices](#)
- [Supported codecs](#)

Disconnecting Bluetooth connection (after use)

- 1 Unlock the screen of the Bluetooth device if it is locked.**
- 2 Touch the one-touch connection (NFC) compatible device again to disconnect it. If the Bluetooth device does not support one-touch connection (NFC), disconnect the device by operating the device.**
When disconnected, you will hear the voice guidance say, "Bluetooth disconnected".
- 3 Turn off the headset.**
You will hear the voice guidance say, "Power off".

Hint

- When you finish playing music, the Bluetooth connection may terminate automatically depending on the Bluetooth device.

Related Topic

- [Disconnecting the Android smartphone with one-touch \(NFC\)](#)
- [Turning off the headset](#)

Using the supplied headphone cable

If you use the headset at a place where it is restricted to use Bluetooth devices such as on an airplane, you can use the headset as noise canceling headphones by connecting a device via the supplied headphone cable and with the headset turned on.

The headset supports High-Resolution Audio playback.

1 Connect a playback device to the headphone cable input jack with the supplied headphone cable.

Be sure to connect the L-shaped plug into the connecting device.

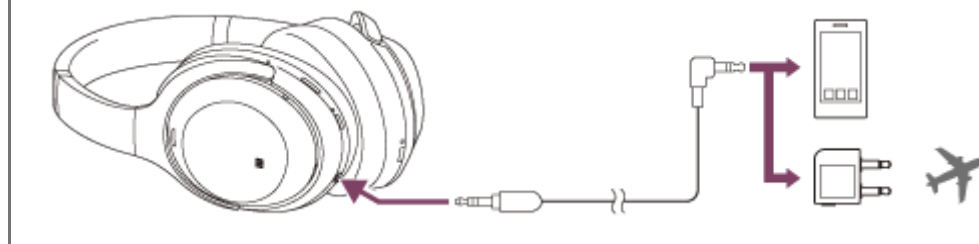

Hint

- You can listen to music even if the headset is turned off. In this case, the noise canceling function cannot be used.
- To enjoy High-Resolution Audio music or use functions such as noise canceling/Ambient Sound Mode, turn the headset on.
- Use the supplied plug adaptor for in-flight use to enjoy the in-flight entertainment.
- The headset turns off automatically if you disconnect the supplied headphone cable from the headset while it is turned on.
- When an incoming call arrives, a ring tone is heard via the headset. Answer the call using your smartphone or mobile phone, and talk using the microphone of the phone. You can hear the caller's voice from the headset. If you disconnect the headphone cable from the smartphone or mobile phone, you can talk using the microphone and speaker of the phone.

Note

- Use the supplied headphone cable only.
- Make sure you insert the plug firmly.
- When using the headphone cable, the Bluetooth function cannot be used.
- You can use Quick Attention Mode and Speak-to-Chat while connected to a device via the supplied headphone cable and with the headset turned on. Perform operations, such as adjusting the volume and play/pause, on the playback device. When the headset is turned off, you cannot use Quick Attention Mode and Speak-to-Chat.
- The CUSTOM button cannot be used when the headset is turned off.
- Depending on the in-flight entertainment, the plug adaptor for in-flight use may not be used.
- When talking on the phone by connecting the headphone cable and the headset, disable Speak-to-Chat because the caller's voice will not be heard from the headset.

Related Topic

- [Using the noise canceling function](#)
- [Listening to ambient sound during music playback \(Ambient Sound Mode\)](#)

- Listening to ambient sound quickly (Quick Attention Mode)
- Speaking with someone while wearing the headset (Speak-to-Chat)

5-013-731-11(4) Copyright 2020 Sony Corporation

Wireless Noise Canceling Stereo Headset
WH-1000XM4

Listening to music from a device via Bluetooth connection

If your Bluetooth device supports the following profiles, you can enjoy listening to music and control the device from your headset via Bluetooth connection.

- A2DP (Advanced Audio Distribution Profile)
You can enjoy high-quality music wirelessly.
- AVRCP (Audio Video Remote Control Profile)
You can adjust the volume, etc.

The operation may vary depending on the Bluetooth device. Refer to the operating instructions supplied with the Bluetooth device.

1 Connect the headset to a Bluetooth device.

2 Put the headset on your ears.

Adjust the length of the headband.

Put the headset on your head with the **Ⓛ** (left) mark on your left ear and the **Ⓡ** (right) mark on your right ear. There is a tactile dot on the **Ⓛ** (left) mark side.

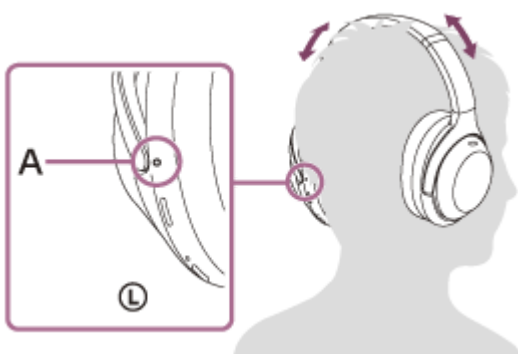

A: Tactile dot

3 Operate the Bluetooth device to start playback and adjust the volume to a moderate level.

4 Adjust the volume using the touch sensor control panel of the headset.

- Increase the volume: Swipe up repeatedly until the volume reaches the desired level.



- Decrease the volume: Swipe down repeatedly until the volume reaches the desired level.



- Change the volume continuously: Swipe up or down and hold. Release at the desired volume level.

When the volume reaches the maximum or minimum, an alarm sounds.

Hint

- The headset supports SCMS-T content protection. You can enjoy music and other audio on the headset from a device such as a mobile phone or portable TV that supports SCMS-T content protection.
- Depending on the Bluetooth device, it may be necessary to adjust the volume or set the audio output setting on the device.
- The headset volume during a call and during music playback can be independently adjusted. Changing the call volume does not change the volume of music playback and vice versa.

Note

- If the communication condition is poor, the Bluetooth device may react incorrectly to the operation on the headset.

Related Topic

- [How to make a wireless connection to Bluetooth devices](#)
- [Controlling the audio device \(Bluetooth connection\)](#)
- [Using the noise canceling function](#)

Wireless Noise Canceling Stereo Headset
WH-1000XM4

Controlling the audio device (Bluetooth connection)

If your Bluetooth device supports the device operating function (compatible protocol: AVRCP), then the following operations are available. The available functions may vary depending on the Bluetooth device, so refer to the operating instructions supplied with the device.

You can use the touch sensor control panel to perform the following operations.

- Play/Pause: Tap the touch sensor control panel twice quickly (with an interval of about 0.4 seconds).

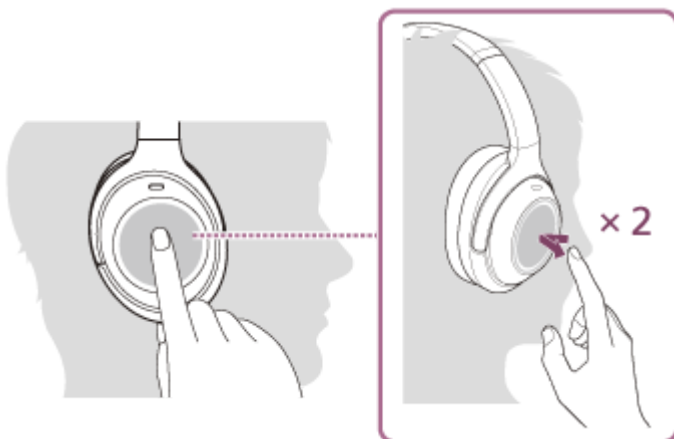

- Skip to the beginning of the next track: Swipe forward and release.



- Skip to the beginning of the previous track (or the current track during playback): Swipe backward and release.

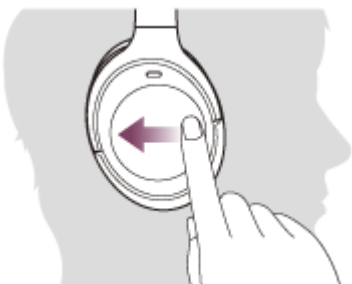

- Fast-forward: Swipe forward and hold. (It takes a while until fast-forwarding starts.) Release at the desired playback point.



- Fast-reverse: Swipe backward and hold. (It takes a while until fast-reversing starts.) Release at the desired playback point.



- Increase the volume: Swipe up repeatedly until the volume reaches the desired level.



- Decrease the volume: Swipe down repeatedly until the volume reaches the desired level.



- Change the volume continuously: Swipe up or down and hold. Release at the desired volume level.

Note

- If the communication condition is poor, the Bluetooth device may react incorrectly to the operation on the headset.
- The available functions may vary depending on the connected device, the music software, or app used. In some cases, it may operate differently or may not work even when the operations described above are performed.

Disconnecting Bluetooth connection (after use)

- 1 Unlock the screen of the Bluetooth device if it is locked.**
- 2 Touch the one-touch connection (NFC) compatible device again to disconnect it. If the Bluetooth device does not support one-touch connection (NFC), disconnect the device by operating the device.**

When disconnected, you will hear the voice guidance say, "Bluetooth disconnected".
- 3 Turn off the headset.**

You will hear the voice guidance say, "Power off".

Hint

- When you finish playing music, the Bluetooth connection may terminate automatically depending on the Bluetooth device.

Related Topic

- [Disconnecting the Android smartphone with one-touch \(NFC\)](#)
- [Turning off the headset](#)

Wireless Noise Canceling Stereo Headset
WH-1000XM4

What is noise canceling?

The noise canceling circuit actually senses outside noise with built-in microphones and sends an equal-but-opposite canceling signal to the headset.

Note

- The effect of noise canceling may not be pronounced in a very quiet environment, or some noise may be heard.
- When you are wearing the headset, depending on how you wear the headset, the effect of noise canceling may vary or a beeping sound (feedback) may be heard. In this case, take off the headset and put it on again.
- The noise canceling function works primarily on noise in the low frequency band such as vehicles and air conditioning. Although noise is reduced, it is not completely canceled.
- When you use the headset in a car or a bus, noise may occur depending on street conditions.
- Mobile phones may cause interference and noise. Should this occur, move the headset further away from the mobile phone.
- Do not cover the microphones on the left and right units of the headset with your hand, etc. The effect of noise canceling or the Ambient Sound Mode may not work properly, or a beeping sound (feedback) may occur. In this case, remove your hand, etc. from the left and right microphones.



A: Microphones (left, right)

Related Topic

- [Using the noise canceling function](#)

Wireless Noise Canceling Stereo Headset
WH-1000XM4

Using the noise canceling function

If you use the noise canceling function, you can enjoy music without being disturbed by ambient noise.

1 Turn on the headset.

You will hear the voice guidance say, "Power on".
The noise canceling function is turned on automatically.

To turn off the noise canceling function

Press the CUSTOM button repeatedly to turn off the noise canceling function.

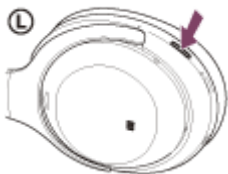

Each time the button is pressed, the function switches as follows and is announced by the voice guidance.

The Ambient Sound Mode: ON



The noise canceling function: OFF/The Ambient Sound Mode: OFF



The noise canceling function: ON

About the instruction manual video

Watch the video to find out how to use the noise canceling function.

https://rd1.sony.net/help/mdr/mov0012/h_zz/

Hint

- If you connect the supplied headphone cable while using the noise canceling function with a Bluetooth connection, the Bluetooth function is turned off, but you can continue to use the noise canceling function.
- When you use the headset as ordinary headphones, turn off the headset and use the supplied headphone cable.
- You can also change the settings of the noise canceling function and Ambient Sound Mode with the "Sony | Headphones Connect" app.

Note

- If the CUSTOM button is set as the Google Assistant button, the noise canceling function and Ambient Sound Mode cannot be switched from the headset. In this case, you can change the settings of the noise canceling function and Ambient Sound Mode with the "Sony | Headphones Connect" app.

- If the CUSTOM button is set as the Amazon Alexa button, the noise canceling function and Ambient Sound Mode cannot be switched from the headset. In this case, you can change the settings of the noise canceling function and Ambient Sound Mode with the “Sony | Headphones Connect” app.

Related Topic

- [About the voice guidance](#)
- [Turning on the headset](#)
- [What is noise canceling?](#)
- [Listening to ambient sound during music playback \(Ambient Sound Mode\)](#)
- [What you can do with the “Sony | Headphones Connect” app](#)

Wireless Noise Canceling Stereo Headset
WH-1000XM4

Optimizing the noise canceling function to suit the wearer (NC Optimizer)

This function optimizes the noise canceling function by detecting the shape of your face, your hairstyle, how you wear the headset due to the presence or absence of glasses, or the pressure change in an airplane.

It is recommended that you run the NC Optimizer function when using the headset for the first time, when the wearing condition has been changed or when the air pressure changes between being on an airplane and on the ground, etc.

- 1 Put on the headset with the power turned on.



- 2 Press and hold the CUSTOM button for about 2 seconds until you hear the voice guidance say, "Optimizer start".



Test signals will be heard during the optimization. When the optimizing process is finished, you will hear the voice guidance say, "Optimizer finished".

About the instruction manual video

Watch the video to find out how to use the NC Optimizer function.

https://rd1.sony.net/help/mdr/mov0014/h_??/

Hint

- It is recommended that you run the NC Optimizer again after changing your hairstyle, removing eyeglasses worn on a daily basis, or implementing other changes to the wearing conditions.

- If you are on an airplane, we recommend that you turn on the NC Optimizer function at the stable flight condition.
- The condition optimized with the NC Optimizer function is retained until the NC Optimizer function is used again. It is recommended that you turn on the NC Optimizer function once again after getting off the airplane and so on.
- The NC Optimizer can also be operated from the “Sony | Headphones Connect” app.

Note

- Put on the headset under the actual usage conditions when running the NC Optimizer. It is recommended that you do not touch the headset while the NC Optimizer is running.
- If the headset receives another operation while performing the NC Optimizer, the optimizing is canceled.
- If the CUSTOM button is set as the Google Assistant button, the NC Optimizer function cannot be operated from the headset.
- If the CUSTOM button is set as the Amazon Alexa button, the NC Optimizer function cannot be operated from the headset.

Related Topic

- [What you can do with the “Sony | Headphones Connect” app](#)

Wireless Noise Canceling Stereo Headset
WH-1000XM4

Listening to ambient sound during music playback (Ambient Sound Mode)

You can hear ambient sound through the microphones embedded in the left and right units of the headset while enjoying music.

To activate the Ambient Sound Mode

Press the CUSTOM button while the noise canceling function is on.

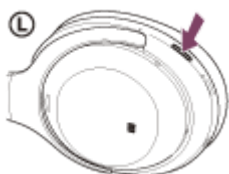

To change the setting of the Ambient Sound Mode

You can change the settings of the Ambient Sound Mode by connecting the smartphone (with the “Sony | Headphones Connect” app installed) and the headset via Bluetooth connection.

Voice focus: Unwanted noise will be suppressed while announcements or people’s voices are picked up, allowing you to hear them as you listen to music.

To turn off the Ambient Sound Mode

Press the CUSTOM button repeatedly until the Ambient Sound Mode is turned off.

Each time the button is pressed, the function switches as follows and is announced by the voice guidance.

The noise canceling function: OFF/The Ambient Sound Mode: OFF



The noise canceling function: ON



The Ambient Sound Mode: ON

About the instruction manual video

Watch the video to find out how to use the Ambient Sound Mode.

https://rd1.sony.net/help/mdr/mov0012/h_zz/

Hint

- Ambient Sound Mode settings changed with the “Sony | Headphones Connect” app are stored in the headset. You can enjoy music with the stored settings of the Ambient Sound Mode even when the headset is connected to other devices which do not have the “Sony | Headphones Connect” app installed.

Note

- Depending on the ambient condition and the type/volume of audio playback, the ambient sound may not be heard even when using the Ambient Sound Mode. Do not use the headset in places where it would be dangerous if you are unable to hear ambient

sounds such as on a road with car and bicycle traffic.

- If the headset is not worn properly, the Ambient Sound Mode may not work correctly. Wear the headset properly.
- If the CUSTOM button is set as the Google Assistant button, the noise canceling function and Ambient Sound Mode cannot be switched from the headset. In this case, you can change the settings of the noise canceling function and Ambient Sound Mode with the “Sony | Headphones Connect” app.
- If the CUSTOM button is set as the Amazon Alexa button, the noise canceling function and Ambient Sound Mode cannot be switched from the headset. In this case, you can change the settings of the noise canceling function and Ambient Sound Mode with the “Sony | Headphones Connect” app.
- Depending on the surrounding environment, wind noise may increase when the Ambient Sound Mode is turned on. In that case, cancel the voice focus with the “Sony | Headphones Connect” app. If the wind noise is still significant, turn off the Ambient Sound Mode.

Related Topic

- [About the voice guidance](#)
- [Using the noise canceling function](#)
- [What you can do with the “Sony | Headphones Connect” app](#)

Wireless Noise Canceling Stereo Headset
WH-1000XM4

Listening to ambient sound quickly (Quick Attention Mode)

This function turns down music, call sounds, and the ringtone to allow ambient sound to be easily heard. It is useful when you want to listen to train announcements, etc.

To activate the Quick Attention Mode

Touch the entire touch sensor control panel of the headset. The Quick Attention Mode is activated only when you are touching the touch sensor control panel.



A: Touch sensor control panel

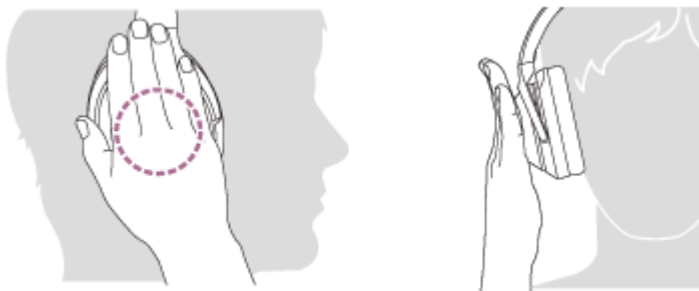

To deactivate the Quick Attention Mode

Release your hand from the touch sensor control panel.

About the instruction manual video

Watch the video to find out how to use the Quick Attention Mode.

https://rd1.sony.net/help/mdr/mov0013/h_zz/

Note

- If you touch as follows, the function may not work properly.
 - The whole touch sensor control panel is not covered.



— The touch sensor control panel is not touched.



- Depending on the ambient condition and the type/volume of audio playback, the ambient sounds may not be heard even when using Quick Attention Mode. Do not use the headset in places where it would be dangerous if you are unable to hear ambient sounds such as on a road with car and bicycle traffic.
- If the headset is not worn properly, the Quick Attention Mode may not work correctly. Wear the headset properly.

Wireless Noise Canceling Stereo Headset
WH-1000XM4

Speaking with someone while wearing the headset (Speak-to-Chat)

If Speak-to-Chat is enabled beforehand, the Speak-to-Chat mode starts automatically when you talk to someone. The headset pauses or mutes the music which is being played and captures the voice of the person you are conversing with on the microphone to make it easier to hear.

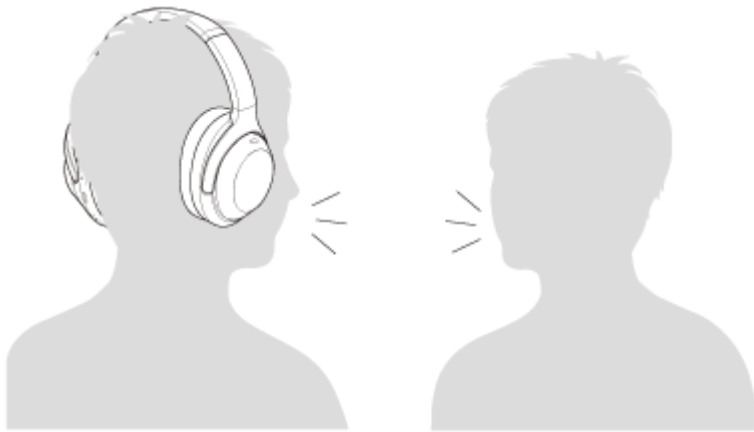

To enable Speak-to-Chat

To activate the Speak-to-Chat mode, the headset's automatic audio detection must be enabled in advance. In the factory setting, Speak-to-Chat is disabled. To enable it, hold 2 fingers to the touch sensor control panel until you hear the voice guidance say, "Speak-to-chat activated".



To disable Speak-to-Chat

Hold 2 fingers to the touch sensor control panel once again until you hear the voice guidance say, "Speak-to-chat deactivated".

About the instruction manual video

Watch the video to find out how to use Speak-to-Chat.

https://rd1.sony.net/help/mdr/mov0015/h_zz/

Hint

- If Speak-to-Chat does not switch to enable/disable properly, operate as described below.
 - Slightly separate both fingers



- Directly touch the touch sensor control panel



- Touch the touch sensor control panel with the pads of your fingers



- The Speak-to-Chat mode ends in the following instances.
 - When the headset does not detect any audio spoken by the person wearing the headset for 30 seconds or more
 - When the user operates the headset buttons or touch sensor control panel
- You can also use the “Sony | Headphones Connect” app to switch between enabled/disabled, change the sensitivity of the automatic audio detection, and change the time until the Speak-to-Chat mode ends.

Note

- The Speak-to-Chat mode activates when it detects the speech of the person wearing the headset, but in rare cases it may activate in response to the voices of other people, ambient environmental sounds, transportation announcements, etc. Disable Speak-to-Chat in cases where the Speak-to-Chat mode frequently activates by accident.
- Due to ambient noise, the speech of the person wearing the headset may not be detected, and the Speak-to-Chat mode may not activate. In this case, try speaking longer and with a louder voice. In some cases, the Speak-to-Chat mode may not activate even when speaking longer and with a louder voice in extremely noisy environments such as in an airplane.
- Music playback is paused while the Speak-to-Chat mode is active only when connected via Bluetooth connection.
- The connected device or playback application you are using may not support pausing of music playback.

Related Topic

- [What you can do with the “Sony | Headphones Connect” app](#)



Wireless Noise Canceling Stereo Headset
WH-1000XM4

About the sound quality mode

The following 2 sound quality modes during Bluetooth playback can be selected. You can switch the settings and check the sound quality mode with the “Sony | Headphones Connect” app.

Priority on sound quality mode: Prioritizes the sound quality (default).

Priority on stable connection mode: Prioritizes the stable connection.

- When you want to prioritize the sound quality, select the “Priority on sound quality” mode.
- If the connection is unstable, such as when producing only intermittent sound, select the “Priority on stable connection” mode.

Note

- The playback time may shorten depending on the sound quality and the conditions under which you are using the headset.
- Depending on the ambient conditions in the area where you are using the headset, intermittent sound may still occur even if the “Priority on stable connection” mode is selected.

Related Topic

- [What you can do with the “Sony | Headphones Connect” app](#)

Wireless Noise Canceling Stereo Headset
WH-1000XM4

Supported codecs

A codec is an audio coding algorithm used when transmitting sound via Bluetooth connection.

The headset supports the following 3 codecs for music playback via an A2DP connection: SBC, AAC, and LDAC.

- SBC

This is an abbreviation for Subband Codec.

SBC is the standard audio coding technology used in Bluetooth devices.

All Bluetooth devices support SBC.

- AAC

This is an abbreviation for Advanced Audio Coding.

AAC is mainly used in Apple products such as iPhone that can provide a higher sound quality than that of SBC.

- LDAC

LDAC is an audio coding technology developed by Sony that enables the transmission of High-Resolution (Hi-Res) Audio content, even over a Bluetooth connection.

Unlike other Bluetooth-compatible coding technologies such as SBC, it operates without any down-conversion of the High-Resolution Audio content (*), and allows approximately 3 times more data (**) than those other technologies to be transmitted over a Bluetooth wireless network with unprecedented sound quality, employing efficient coding and optimized packetization.

* excluding DSD format contents.

** in comparison with SBC when the bitrate of 990 kbps (96/48 kHz) or 909 kbps (88.2/44.1 kHz) is selected.

When music in one of the above codecs is transmitted from a connected device, the headset switches to that codec automatically and plays back the music in the same codec.

If the connected device supports a codec of higher sound quality than SBC, you may need to set the device beforehand to enjoy music with the desired codec from the supported codecs.

Refer to the operating instructions supplied with the device regarding setting the codec.

Related Topic

- [About the sound quality mode](#)

Wireless Noise Canceling Stereo Headset
WH-1000XM4

About the DSEE Extreme function

DSEE Extreme uses AI technology to reproduce with high accuracy the frequency responses of the original sound source lost during compression.

Receiving a call

You can enjoy a hands-free call with a smartphone or mobile phone that supports the Bluetooth profile HFP (Hands-free Profile) or HSP (Headset Profile), via Bluetooth connection.

- If your smartphone or mobile phone supports both HFP and HSP, set it to HFP.
- The operation may vary depending on the smartphone or mobile phone. Refer to the operating instructions supplied with the smartphone or mobile phone.
- Only ordinary phone calls are supported. Applications for phone calls on smartphones or personal computers are not supported.

Ring tone

When an incoming call arrives, a ring tone will be heard from the headset, and the indicator (blue) flashes quickly. You will hear either of following ring tones, depending on your smartphone or mobile phone.

- Ring tone set on the headset
- Ring tone set on the smartphone or mobile phone
- Ring tone set on the smartphone or mobile phone only for a Bluetooth connection

1 Connect the headset to a smartphone or mobile phone via Bluetooth connection beforehand.

2 When you hear the ring tone, tap the touch sensor control panel twice quickly (with an interval of about 0.4 seconds) to receive the call.

When an incoming call arrives while you are listening to music, playback pauses and a ring tone will be heard from the headset.

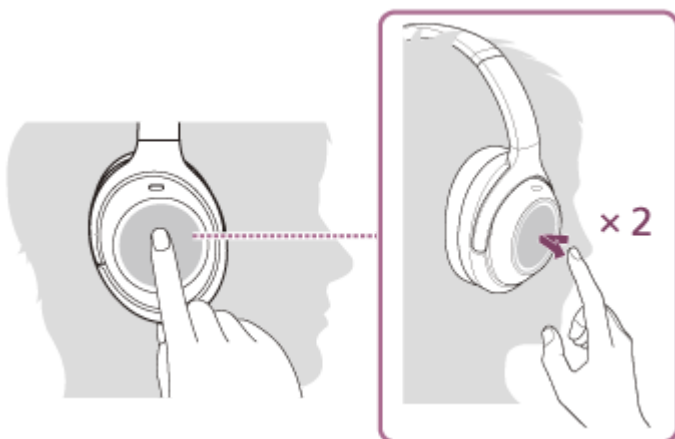

The headset has omnidirectional microphones. You can talk without worrying about the position of the microphone.

If no ring tone is heard via the headset

- The headset may not be connected with the smartphone or mobile phone over HFP or HSP. Check the connection status on the smartphone or mobile phone.
- If playback does not pause automatically, operate the headset to pause playback.

3 Adjust the volume using the touch sensor control panel.

- Increase the volume: Swipe up repeatedly until the volume reaches the desired level.



- Decrease the volume: Swipe down repeatedly until the volume reaches the desired level.



- Change the volume continuously: Swipe up or down and hold. Release at the desired volume level.

When the volume reaches the maximum or minimum, an alarm sounds.

4 When you finish your phone call, tap the touch sensor control panel twice quickly (with an interval of about 0.4 seconds) to end the call.

If you received a call during music playback, music playback resumes automatically after ending the call.

Hint

- When receiving a call by operating smartphones or mobile phones, some smartphones or mobile phones receive a call with the phone instead of the headset. With an HFP or HSP connection, switch the call to the headset by holding your finger to the headset's touch sensor control panel until it switches, or by using your smartphone or mobile phone.
- Volume for a call can be adjusted during a telephone conversation only.
- The headset volume during a call and during music playback can be independently adjusted. Changing the call volume does not change the volume of music playback and vice versa.

Note

- Depending on the smartphone or mobile phone, when an incoming call arrives while you are listening to music, playback may not resume automatically even if you finish the call.
- Use a smartphone or mobile phone at least 50 cm (19.69 in.) away from the headset. Noise may result if the smartphone or mobile phone is too close to the headset.
- Your voice will be heard from the headset through the headset's microphone (Sidetone function). In this case, ambient sounds or the sounds of the headset operation may be heard through the headset, but this is not a malfunction.

Related Topic

- [How to make a wireless connection to Bluetooth devices](#)
- [Making a call](#)
- [Functions for a phone call](#)

Wireless Noise Canceling Stereo Headset
WH-1000XM4

Making a call

You can enjoy a hands-free call with a smartphone or mobile phone that supports the Bluetooth profile HFP (Hands-free Profile) or HSP (Headset Profile), via Bluetooth connection.

- If your smartphone or mobile phone supports both HFP and HSP, set it to HFP.
- The operation may vary depending on the smartphone or mobile phone. Refer to the operating instructions supplied with the smartphone or mobile phone.
- Only ordinary phone calls are supported. Applications for phone calls on smartphones or personal computers are not supported.

1 Connect the headset to a smartphone/mobile phone via Bluetooth connection.

2 Operate your smartphone or mobile phone to make a call.

When you make a call, the dial tone is heard from the headset.

If you make a call while you are listening to music, playback pauses.

If no dial tone is heard via the headset, switch the call device to the headset using your smartphone or mobile phone or by holding your finger to the touch sensor control panel until the device is switched.



The headset has omnidirectional microphones. You can talk without worrying about the position of the microphone.

3 Adjust the volume using the touch sensor control panel.

- Increase the volume: Swipe up repeatedly until the volume reaches the desired level.



- Decrease the volume: Swipe down repeatedly until the volume reaches the desired level.



- Change the volume continuously: Swipe up or down and hold. Release at the desired volume level.

When the volume reaches the maximum or minimum, an alarm sounds.

4 **When you finish your phone call, tap the touch sensor control panel twice quickly (with an interval of about 0.4 seconds) to end the call.**

If you made a call during music playback, music playback resumes automatically after ending the call.

Hint

- Volume for a call can be adjusted during a telephone conversation only.
- The headset volume during a call and during music playback can be independently adjusted. Changing the call volume does not change the volume of music playback and vice versa.

Note

- Use a smartphone or mobile phone at least 50 cm (19.69 in.) away from the headset. Noise may result if the smartphone or mobile phone is too close to the headset.
- Your voice will be heard from the headset through the headset's microphone (Sidetone function). In this case, ambient sounds or the sounds of the headset operation may be heard through the headset, but this is not a malfunction.

Related Topic

- [How to make a wireless connection to Bluetooth devices](#)
- [Receiving a call](#)
- [Functions for a phone call](#)

Wireless Noise Canceling Stereo Headset
WH-1000XM4

Functions for a phone call

The functions available during a call may vary depending on the profile supported by your smartphone or mobile phone. In addition, even if the profile is the same, the functions may vary depending on the smartphone or mobile phone. Refer to the operating instructions supplied with the smartphone or mobile phone.

Supported profile: HFP (Hands-free Profile)

During standby/music playback

- Hold your finger to the touch sensor control panel for about 2 seconds to start up the voice dial function (*) of the smartphone/mobile phone, or activate the Google™ app on the Android smartphone or Siri on the iPhone.



Outgoing call

- Tap the touch sensor control panel twice quickly (with an interval of about 0.4 seconds) to cancel an outgoing call.
- Hold your finger to the touch sensor control panel to change the call device back and forth from the headset to the smartphone/mobile phone.

Incoming call

- Tap the touch sensor control panel twice quickly to answer a call.
- Hold your finger to the touch sensor control panel to reject a call.

During call

- Tap the touch sensor control panel twice quickly to finish a call.
- Hold your finger to the touch sensor control panel to change the call device back and forth from the headset to the smartphone/mobile phone.

Supported profile: HSP (Headset Profile)

Outgoing call

- Tap the touch sensor control panel twice quickly to cancel an outgoing call. (*)

Incoming call

- Tap the touch sensor control panel twice quickly to answer a call.

During call

- Tap the touch sensor control panel twice quickly to finish a call. (*)

* Some devices may not support this function.

Related Topic

- [Receiving a call](#)
- [Making a call](#)

5-013-731-11(4) Copyright 2020 Sony Corporation

Making a video call on a computer

When you make a video call on your computer, you can talk wirelessly from your headset.

- 1 **Connect the headset to your computer via Bluetooth connection.**
- 2 **Launch the video calling application on your computer.**
- 3 **Check the settings (*) of the video calling application.**
 - When you make a video call on your computer, select calling connections (HFP/HSP) and not music playback connections (A2DP). If you select music playback connections, a video call may not be available.
 - On the speaker settings, select calling connections [Headset (WH-1000XM4 Hands-Free)] (**). ([Headphones (WH-1000XM4 Stereo)] (** is for music playback connections.)
 - On the microphone settings, select calling connections [Headset (WH-1000XM4 Hands-Free)] (**). When the microphone is not set up, the Speak-to-Chat mode activates when it detects the speech of the person wearing the headset, and the sound from the headset is muted.
 - Depending on the video calling application you are using, calling connections [Headset (WH-1000XM4 Hands-Free)] (**) or music playback connections [Headphones (WH-1000XM4 Stereo)] (**) may not be selectable on the speaker or microphone settings, and only [WH-1000XM4] may be displayed. In that case, select [WH-1000XM4].
 - As for frequently asked questions and answers, refer to the customer support website.

* Depending on the video calling application you are using, this function may not be available.

** Names may vary according to the computer or the video calling application you are using.

Hint

- When the settings of the video calling application cannot be checked or calling connections [Headset (WH-1000XM4 Hands-Free)] cannot be selected, select [Headset (WH-1000XM4 Hands-Free)] on the settings of your computer to make connections. See [“Connecting to a paired computer \(Windows 10\)”](#), [“Connecting to a paired computer \(Windows 8.1\)”](#) or [“Connecting to a paired computer \(Mac\)”](#).

Note

- Depending on the video calling application you are using, microphone settings may not be available. In that case, disable Speak-to-Chat. To disable it, hold 2 fingers to the touch sensor control panel until you hear the voice guidance say, “Speak-to-chat deactivated”.

Related Topic

- [How to make a wireless connection to Bluetooth devices](#)
- [Pairing and connecting with a computer \(Windows 10\)](#)
- [Pairing and connecting with a computer \(Windows 8.1\)](#)
- [Pairing and connecting with a computer \(Mac\)](#)
- [Connecting to a paired computer \(Windows 10\)](#)
- [Connecting to a paired computer \(Windows 8.1\)](#)
- [Connecting to a paired computer \(Mac\)](#)

- [Disconnecting Bluetooth connection \(after use\)](#)
- [Speaking with someone while wearing the headset \(Speak-to-Chat\)](#)
- [Customer support websites](#)

5-013-731-11(4) Copyright 2020 Sony Corporation

Disconnecting Bluetooth connection (after use)

- 1** **Unlock the screen of the Bluetooth device if it is locked.**
- 2** **Touch the one-touch connection (NFC) compatible device again to disconnect it. If the Bluetooth device does not support one-touch connection (NFC), disconnect the device by operating the device.**

When disconnected, you will hear the voice guidance say, "Bluetooth disconnected".
- 3** **Turn off the headset.**

You will hear the voice guidance say, "Power off".

Hint

- When you finish playing music, the Bluetooth connection may terminate automatically depending on the Bluetooth device.

Related Topic

- [Disconnecting the Android smartphone with one-touch \(NFC\)](#)
- [Turning off the headset](#)

Wireless Noise Canceling Stereo Headset
WH-1000XM4

Using the Google Assistant

By using the Google Assistant feature that comes with the smartphone, you can speak to the headset's microphone to operate the smartphone or perform a search.

Compatible smartphones

- Smartphones installed with Android 5.0 or later (The latest version of the Google app is required.)
- iPhone/iPod touch (Installation of the Google Assistant app is required.)

1 If your smartphone is an iPhone/iPod touch, open the Google Assistant app.

If your smartphone is an Android smartphone, skip this step.

2 Open the "Sony | Headphones Connect" app, and set the CUSTOM button as the Google Assistant button.

When using the Google Assistant for the first time, open the Google Assistant app and touch [Finish headphones setup] on the Conversation View, and follow the on-screen instructions to complete initial settings for the Google Assistant.

For details on the "Sony | Headphones Connect" app, refer to the following URL.

https://rd1.sony.net/help/mdr/hpc/h_zz/

3 Press the CUSTOM button to use the Google Assistant.

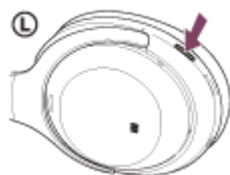

- Press and hold the button: Input a voice command
- Press the button once: Read out the notification
- Press the button twice quickly: Cancel the voice command

For details on the Google Assistant, refer to the following website:

<https://assistant.google.com>

<https://g.co/headphones/help>

Hint

- Check or update the software version of the headset with the "Sony | Headphones Connect" app.
- When the Google Assistant is not available for reasons such as not being connected to the network, the voice guidance "The Google Assistant is not connected" is heard.
- If you do not see [Finish headphones setup] on the Conversation View of the Google Assistant app, delete the pairing information for the headset from the Bluetooth settings of your smartphone and redo the pairing process.

Note

- If the CUSTOM button is set as the Google Assistant button in step 2, the noise canceling function, the Ambient Sound Mode, and the NC Optimizer function cannot be operated from the headset.

- If the CUSTOM button is set as the Google Assistant button in step 2, the voice assist function (Google app) cannot be used.
- If the CUSTOM button is set as the Google Assistant button in step 2, the Amazon Alexa function cannot be operated from the headset.
- The Google Assistant may not be used in some countries, regions, or languages.

5-013-731-11(4) Copyright 2020 Sony Corporation

Wireless Noise Canceling Stereo Headset
WH-1000XM4

Using Amazon Alexa

By using the Amazon Alexa app installed on your smartphone, you can speak to the headset's microphone to operate the smartphone or perform a search.

Compatible smartphones

- The OS version supported by the latest version of the Amazon Alexa app on Android or iOS
- Installation of the latest Amazon Alexa app is required.
 1. Open the app store on your mobile device.
 2. Search for Amazon Alexa app.
 3. Select Install.
 4. Select Open.

1 Turn on the headset, and connect the headset to the smartphone via Bluetooth connection.

2 Open the Amazon Alexa app.

When you use Amazon Alexa for the first time, you will need to login with your Amazon account, and proceed to step **3** to set up your headset to the Amazon Alexa app.

If you have already set up Amazon Alexa before, but have configured the CUSTOM button to a function other than Amazon Alexa, refer to the hint section below to reconfigure the CUSTOM button to Amazon Alexa.

3 Perform the initial settings for Amazon Alexa.

1. Touch the menu icon in the upper left corner of the Amazon Alexa app screen, and touch [Add Device].



2. On the [What type of device are you setting up?] screen, select [Headphones].

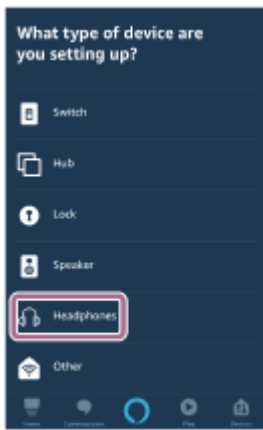

3. From [AVAILABLE DEVICES] on the [Select your device] screen, select [WH-1000XM4].

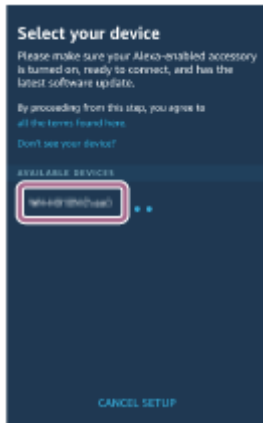

If [WH-1000XM4] and [LE_WH-1000XM4] are displayed in [AVAILABLE DEVICES], select [WH-1000XM4]. [LE_WH-1000XM4] will be displayed first, but wait until [WH-1000XM4] is displayed.

It may take about 30 seconds to 1 minute for [WH-1000XM4] to be displayed.

If you cannot find [WH-1000XM4], the headset is not connected to the smartphone via Bluetooth connection. Connect the headset to the smartphone via Bluetooth connection.

4. On the [Set up Alexa on your WH-1000XM4] screen, touch [CONTINUE].

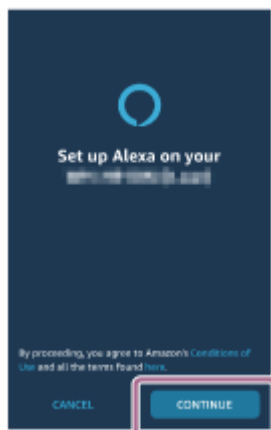

5. If the [This will override the current voice assistant on this accessory] screen appears, touch [CONTINUE].



6. On the [Setup Complete] screen, touch [DONE].

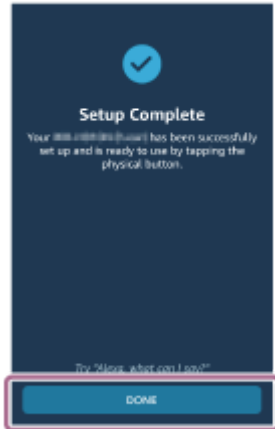

When the initial settings are complete, the CUSTOM button on the headset is set as the Amazon Alexa button.

4 Press the CUSTOM button to use Amazon Alexa.

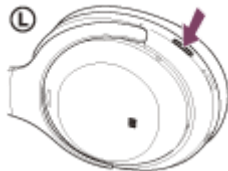

- Press briefly to input a voice command.
Example:
“What is the weather”
“Play music (*)”
* Need Amazon or Prime Music subscription.
- If there is no voice, it will be automatically canceled.

For details on Amazon Alexa and its capability, refer to the following website:

<https://www.amazon.com/b?node=16067214011>

For details on Amazon Alexa, refer to the following website:

<https://www.amazon.com/gp/help/customer/display.html?nodeId=G7HPV3YLTGLJEJFK>

Hint

- When you set up the headset to Amazon Alexa, the CUSTOM button will be automatically configured for Amazon Alexa. You can restore the button back to original function by changing it with the “Sony | Headphones Connect” app. Similarly, you can reconfigure the button back to Amazon Alexa if you have previously connected to Amazon Alexa, but have changed to another function.
- Check or update the software version of the headset with the “Sony | Headphones Connect” app.

- When Amazon Alexa is not available for reasons such as not being connected to the network, the voice guidance “Either your mobile device isn’t connected; or you need to open the Alexa App and try again” is heard.

Note

- If the CUSTOM button is set as the Amazon Alexa button, the noise canceling function, Ambient Sound Mode, and NC Optimizer function cannot be operated from the headset.
- If the CUSTOM button is set as the Amazon Alexa button, the voice assist function (Google app) cannot be used.
- If the CUSTOM button is set as the Amazon Alexa button, the Google Assistant function cannot be operated from the headset.
- Amazon Alexa is not available in all languages and countries/regions. See www.amazon.com/alexa-availability for details.

Using the voice assist function (Google app)

By using the Google app feature that comes with the Android smartphone, you can speak to the headset's microphone to operate the Android smartphone.

1 Set the assist and voice input selection to the Google app.

On the Android smartphone, select [Settings] - [Apps & notifications] - [Advanced] - [Default apps] - [Assist & voice input], and set [Assist app] to the Google app.

The operation above is an example. For details, refer to the operating instructions of the Android smartphone.

Note: The latest version of the Google app may be required.

For details on the Google app, refer to the operating instructions or the support website of the Android smartphone, or the Google Play store website.

The Google app may not be activated from the headset depending on specifications of the Android smartphone.

2 Connect the headset to the Android smartphone via Bluetooth connection.

3 When the Android smartphone is in standby or playing music, hold your finger to the headset's touch sensor control panel for about 2 seconds.



The Google app is activated.

4 Make a request to the Google app while wearing the headset on your ears.

For details on the apps which work with the Google app, refer to the operating instructions of the Android smartphone.

After activating the Google app, the voice command is canceled when a certain time has passed without requests.

Note

- If the CUSTOM button is set as the Google Assistant button, the voice assist function (Google app) is not available.
- If the CUSTOM button is set as the Amazon Alexa button, the voice assist function (Google app) is not available.
- The Google app cannot be activated when you say "Ok Google" even when the Android smartphone's "Ok Google" setting is on.
- When using the voice assist function, your voice will be heard from the headset through the headset's microphone (Sidetone function). In this case, ambient sounds or the sounds of the headset operation may be heard through the headset, but this is not

a malfunction.

- The Google app may not be activated depending on specifications of the smartphone or application version.
- The Google app does not work when connected to a device not compatible with the voice assist function.

5-013-731-11(4) Copyright 2020 Sony Corporation

Using the voice assist function (Siri)

By using the Siri feature that comes with iPhone, you can speak to the headset's microphone to operate the iPhone.

1 Turn Siri on.

On iPhone, select [Settings] - [Siri & Search] to turn [Press Home for Siri] and [Allow Siri When Locked] on. The operation above is an example. For details, refer to the operating instructions of the iPhone.
Note: For details on Siri, refer to the operating instructions or support website of the iPhone.

2 Connect the headset to the iPhone via Bluetooth connection.

3 When the iPhone is in standby or playing music, hold your finger to the headset's touch sensor control panel for about 2 seconds.



Siri is activated.

4 Make a request to Siri while wearing the headset on your ears.

For details on the apps which work with Siri, refer to the operating instructions of the iPhone.

5 To continue to request, tap the touch sensor control panel twice quickly (with an interval of about 0.4 seconds) before Siri is deactivated.

After activating Siri, when a certain time has passed without requests, Siri will be deactivated.

Note

- Siri cannot be activated when you say "Hey Siri" even when the iPhone's "Hey Siri" setting is on.
- When using the voice assist function, your voice will be heard from the headset through the headset's microphone (Sidetone function). In this case, ambient sounds or the sounds of the headset operation may be heard through the headset, but this is not a malfunction.
- Siri may not be activated depending on specifications of the smartphone or application version.

Wireless Noise Canceling Stereo Headset
WH-1000XM4

What you can do with the “Sony | Headphones Connect” app

When you connect the smartphone with the “Sony | Headphones Connect” app installed and the headset via Bluetooth connection, you can do the following.

- Easy pairing
- Display the remaining battery charge of the headset
- Display the Bluetooth connection codec
- Adjust the noise canceling function and Ambient Sound Mode (ambient sound control)
- Use auto adjustment of the noise canceling function by behavior recognition (Adaptive Sound Control)
- NC Optimizer (Optimizing the noise canceling function)
- Switch between enabled/disabled the automatic audio detection and set the Speak-to-Chat
- Select the Equalizer setting
- Customize the Equalizer setting
- Set the Bluetooth connection mode (sound quality mode)
- Set the DSEE Extreme (completion for high-range sound) function
- Change the function of the CUSTOM button
- Turn off the headset
- Adjust the playback volume
- Play/pause music, skip to the beginning of the previous track (or the current track during playback)/skip to the beginning of the next track
- Check the connection status and the settings of the headset
- Check the headset software version
- Update the headset software
- Switch the voice guidance language
- Turn the voice guidance on/off
- Switch the touch sensor control panel on/off setting
- Set the wearing detection automatic power off function
- Set the wearing detection automatic music playback pause and resume function
- Switch the multipoint connection (Connect the headset to 2 devices simultaneously) on/off setting

For details on the “Sony | Headphones Connect” app, refer to the following URL.

https://rd1.sony.net/help/mdr/hpc/h_zz/

Hint

- The operation of the “Sony | Headphones Connect” app differs depending on the audio device. The app specifications and screen design may change without prior notice.

Related Topic

- [Installing the “Sony | Headphones Connect” app](#)
- [Checking the remaining battery charge](#)
- [Using the noise canceling function](#)
- [Optimizing the noise canceling function to suit the wearer \(NC Optimizer\)](#)
- [Listening to ambient sound during music playback \(Ambient Sound Mode\)](#)
- [About the sound quality mode](#)
- [Supported codecs](#)
- [About the DSEE Extreme function](#)
- [Connecting the headset to 2 devices simultaneously \(multipoint connection\)](#)

Wireless Noise Canceling Stereo Headset
WH-1000XM4

Installing the “Sony | Headphones Connect” app

- 1 Download the “Sony | Headphones Connect” app from the Google Play store or App Store, and install the app on your smartphone.

For details on the “Sony | Headphones Connect” app, refer to the following URL.

https://rd1.sony.net/help/mdr/hpc/h_zz/



Sony Headphones Connect 

- 2 After installing the app, launch the “Sony | Headphones Connect” app.

Related Topic

- [What you can do with the “Sony | Headphones Connect” app](#)

Wireless Noise Canceling Stereo Headset
WH-1000XM4

Accessing support information from the “Sony | Headphones Connect” app

You can access the latest support information from the “Sony | Headphones Connect” app.

- 1 Select [Help] on the “Sony | Headphones Connect” app screen.
- 2 The [Headphones Connect Help] screen appears and support information is displayed.
- 3 Select the desired item.

Wireless Noise Canceling Stereo Headset
WH-1000XM4

Updating the headset software

Install the latest headset software using the “Sony | Headphones Connect” app to enjoy new functions or to resolve a certain number of issues with the headset.

Always use the headset with the latest software installed.

For details on the latest headset software and how to update the software, refer to the information on the support website.

When the [Automatic download of software] setting is enabled (default setting) on the “Sony | Headphones Connect” app, the download and transfer of the software will start automatically.

You can also update the headset software in the following way.

- 1 Download the update software from the server to the smartphone on which the “Sony | Headphones Connect” app is installed.**
- 2 Transfer the update software from the smartphone to the headset.**
- 3 Update the headset software following the on-screen instructions.**

Related Topic

- [What you can do with the “Sony | Headphones Connect” app](#)

Precautions

On Bluetooth communications

- Bluetooth wireless technology operates within a range of about 10 m (30 feet). The maximum communication distance may vary depending on the presence of obstacles (people, metal objects, walls, etc.) or the electromagnetic environment.
- Microwaves emitting from a Bluetooth device may affect the operation of electronic medical devices. Turn off this unit and other Bluetooth devices in the following locations, as it may cause an accident:
 - in hospitals, near priority seating in trains, locations where inflammable gas is present, near automatic doors, or near fire alarms.
- When you use the headset on an airplane, follow the instructions of cabin attendants or ask the airline you fly with about conditions for using the headset. If you do not use the supplied headphone cable, radio waves may affect instruments, causing risk of accident due to malfunction. Be sure that you use the supplied headphone cable on an airplane.
- The audio playback on this unit may be delayed from that on the transmitting device, due to the characteristics of Bluetooth wireless technology. As a result, the sound may not be in sync with the image when viewing movies or playing games.
- The unit supports security functions that comply with the Bluetooth standard as a means of ensuring security during communication using Bluetooth wireless technology. However, depending on the configured settings and other factors, this security may not be sufficient. Be careful when communicating using Bluetooth wireless technology.
- Sony shall assume no responsibility for any damages or loss resulting from information leaks that occur when using Bluetooth communications.
- Bluetooth connections with all Bluetooth devices cannot be guaranteed.
 - Bluetooth devices connected with the unit must comply with the Bluetooth standard prescribed by Bluetooth SIG, Inc., and must be certified as compliant.
 - Even when a connected device complies with the Bluetooth standard, there may be cases where the characteristics or specifications of the Bluetooth device make it unable to connect, or result in different control methods, display, or operation.
 - When using the unit to perform hands-free talking on the phone, noise may occur depending on the connected device or the communication environment.
- Depending on the device to be connected, it may require some time to start communications.

Note on static electricity

- Static electricity accumulated in the body may cause mild tingling in your ears. To reduce the effect, wear clothes made from natural materials, which suppress the generation of static electricity.

Notes on wearing the unit

- Because the headphones achieve a tight seal over the ears, forcibly pressing them against your ears or quickly pulling them off can result in eardrum damage. When wearing the headset, the speaker diaphragm may produce a click sound. This is not a malfunction.

Other notes

- Do not subject the unit to excessive shock.
- The touch sensor may not operate properly if you apply stickers or other adhesive items to the touch sensor control panel.
- Be careful not to catch your finger in the unit when folding.
- When you use the unit as wired headphones, use the supplied headphone cable only. Make sure that the headphone cable is firmly inserted.

- The Bluetooth function may not work with a mobile phone, depending on the signal conditions and the surrounding environment.
- Do not apply weight or pressure to the unit for long periods, including when it is stored, as it may cause deformation.
- If you experience discomfort while using the unit, stop using it immediately.
- The earpads may be damaged or deteriorate with long-term use and storage.
- The unit is not waterproof. If water or foreign objects enter the unit, it may result in fire or electric shock. If water or a foreign object enters the unit, stop use immediately and consult your nearest Sony dealer. In particular, be careful in the following cases.
 - When using the unit around a sink, etc.
Be careful that the unit does not fall into a sink or container filled with water.
 - When using the unit in the rain or snow, or in humid locations
 - When using the unit while you are sweaty
If you touch the unit with wet hands, or put the unit in the pocket of a damp article of clothing, the unit may get wet.

Cleaning the unit

- When the outside of the unit is dirty, clean it by wiping with a soft dry cloth. If the unit is particularly dirty, soak a cloth in a dilute solution of neutral detergent, and wring it well before wiping. Do not use solvents such as thinner, benzene, or alcohol, as they may damage the surface.

Do not use the headset near medical devices

- Radio waves can affect cardiac pacemakers and medical devices. Do not use the headset in crowded places such as crowded trains or inside a medical institution.
- The headset (including accessories) has magnet(s) which may interfere with pacemakers, programmable shunt valves for hydrocephalus treatment, or other medical devices. Do not place the headset close to persons who use such medical devices. Consult your doctor before using the headset if you use any such medical device.

Keep the headset away from the magnetic card

- The headset uses magnets. If you bring a magnetic card close to the headset, the card magnet may be affected and become unusable.

Wireless Noise Canceling Stereo Headset
WH-1000XM4

License notice

Notes on the License

This product contains software that Sony uses under a licensing agreement with the owner of its copyright. We are obligated to announce the contents of the agreement to customers under requirement by the owner of copyright for the software.

Please access the following URL and read the contents of the license.

<https://rd1.sony.net/help/mdr/sl/20/>

Disclaimer regarding services offered by third parties

Services offered by third parties may be changed, suspended, or terminated without prior notice. Sony does not bear any responsibility in these sorts of situations.

Wireless Noise Canceling Stereo Headset
WH-1000XM4

Trademarks

- Windows is a registered trademark or trademark of Microsoft Corporation in the United States and/or other countries.
- iPhone, iPod touch, macOS, Mac and Siri are trademarks of Apple Inc., registered in the U.S. and other countries.
- App Store is a service mark of Apple Inc., registered in the U.S. and other countries.
- IOS is a trademark or registered trademark of Cisco in the U.S. and other countries and is used under license.
- Google, Android and Google Play are trademarks of Google LLC.
- Amazon, Alexa and all related logos are trademarks of Amazon.com, Inc. or its affiliates.
- The Bluetooth® word mark and logos are registered trademarks owned by the Bluetooth SIG, Inc. and any use of such marks by Sony Corporation is under license.
- The N-Mark is a trademark or registered trademark of NFC Forum, Inc. in the United States and in other countries.
- The LDAC name and logo are trademarks of Sony Corporation.
- USB Type-C® and USB-C® are registered trademarks of USB Implementers Forum.
- "DSEE" and "DSEE Extreme" are trademarks of Sony Corporation.

Other trademarks and trade names are those of their respective owners.

Wireless Noise Canceling Stereo Headset
WH-1000XM4

Customer support websites

For customers in the U.S.A, Canada, and Latin America:

<https://www.sony.com/am/support>

For customers in European countries:

<https://www.sony.eu/support>

For customers in China:

<https://service.sony.com.cn>

For customers in other countries/regions:

<https://www.sony-asia.com/support>

Wireless Noise Canceling Stereo Headset
WH-1000XM4

What can I do to solve a problem?

If the headset does not function as expected, try the following steps to resolve the issue.

- Find the symptoms of the issue in this Help Guide, and try any corrective actions listed.
- Charge the headset.
You may be able to resolve some issues by charging the headset battery.
- Reset the headset.
- Initialize the headset.
This operation resets volume settings, etc. to the factory settings, and deletes all pairing information.
- Look up information on the issue on the customer support website.

If the operations above do not work, consult your nearest Sony dealer.

Related Topic

- [Charging the headset](#)
- [Customer support websites](#)
- [Resetting the headset](#)
- [Initializing the headset to restore factory settings](#)

Wireless Noise Canceling Stereo Headset
WH-1000XM4

Unable to turn on the headset.

- Make sure the battery is fully charged.
 - The headset cannot be turned on while charging the battery. Remove the USB Type-C cable and turn on the headset.
 - Reset the headset.
-

Related Topic

- [Charging the headset](#)
- [Checking the remaining battery charge](#)
- [Resetting the headset](#)

Wireless Noise Canceling Stereo Headset
WH-1000XM4

Charging cannot be done.

- Be sure to use the supplied USB Type-C cable.
 - Check that the USB Type-C cable is firmly connected to the headset and the USB AC adaptor or computer.
 - Make sure that the USB AC adaptor is firmly connected to the AC outlet.
 - Check that the computer is turned on.
 - Wake the computer up if the computer is in standby (sleep) or hibernation mode.
 - When using Windows 8.1, update using Windows Update.
 - Reset the headset.
-

Related Topic

- [Charging the headset](#)
- [Resetting the headset](#)

Wireless Noise Canceling Stereo Headset
WH-1000XM4

Charging time is too long.

- Check that the headset and the computer are directly connected, not via a USB hub.
 - Check that you are using a commercially available USB AC adaptor capable of supplying an output current of 1.5 A or more.
 - Check that you are using the supplied USB Type-C cable.
-
-

Related Topic

- [Charging the headset](#)

Wireless Noise Canceling Stereo Headset
WH-1000XM4

The headset cannot be charged even if connecting the headset to a computer.

- Check that the supplied USB Type-C cable is properly connected to the USB port of the computer.
- Check that the headset and the computer are directly connected, not via a USB hub.
- There may be a problem with the USB port of the connected computer. Try connecting to another USB port on the computer if one is available.
- Try the USB connection procedure again in cases other than those stated above.

Wireless Noise Canceling Stereo Headset
WH-1000XM4

The remaining battery charge of the headset is not displayed on the screen of smartphone.

-
- Only the iOS devices (including iPhone/iPod touch) which support HFP (Hands-free Profile), and Android smartphone (OS 8.1 or later) can display the remaining battery charge.
 - Check that the smartphone is connected with HFP. If the smartphone is not connected with HFP, the remaining battery charge will not be correctly displayed.
-
-

Related Topic

- [Checking the remaining battery charge](#)

No sound

- Check that both the headset and the connected device (i.e., smartphone) are turned on.
 - When playing music, check that the headset and the transmitting Bluetooth device are connected via an A2DP Bluetooth connection.
 - When using a video calling application on a computer, check that the headset and the computer are connected via an HFP or HSP Bluetooth connection.
Depending on the video calling application you are using, microphone settings may not be available. In that case, disable Speak-to-Chat.
 - Turn up the volume if it is too low.
 - Check that the connected device is playing back.
 - If you are connecting a computer to the headset, make sure the audio output setting of the computer is set for a Bluetooth device.
 - Pair the headset and the Bluetooth device again.
 - Check that the headphone cable is connected firmly.
 - When Speak-to-Chat is enabled, the Speak-to-Chat mode may launch and respond to the audio (in particular, recordings of conversations in foreign language study materials) that is playing even when the headset is not being worn. In this case, use the headset buttons or touch panel to exit the Speak-to-Chat mode.
 - Reset the headset.
 - Charge the headset. Check if the sound is output from the headset after charging.
 - Initialize the headset, and pair the headset and the device again.
-

Related Topic

- [How to make a wireless connection to Bluetooth devices](#)
- [Using the supplied headphone cable](#)
- [Listening to music from a device via Bluetooth connection](#)
- [Making a video call on a computer](#)
- [Speaking with someone while wearing the headset \(Speak-to-Chat\)](#)
- [Resetting the headset](#)
- [Initializing the headset to restore factory settings](#)

Wireless Noise Canceling Stereo Headset
WH-1000XM4

Low sound level

- Turn up the volume of the headset and the connected device.
- Connect the Bluetooth device to the headset once again.

5-013-731-11(4) Copyright 2020 Sony Corporation

Low sound quality

- Turn down the volume of the connected device if it is too loud.
- Keep the headset away from a microwave oven, wireless LAN device, etc.
- Bring the headset closer to the Bluetooth device. Remove any obstacles between the headset and the Bluetooth device.
- Keep the headset away from a TV.
- When playing music, if the headset and the transmitting Bluetooth device are connected via an HFP or HSP Bluetooth connection, switch the Bluetooth connection to A2DP with the connected device.
- When using a video calling application on a computer, switch the Bluetooth connection to HFP or HSP with the computer.
During a video call, sound quality may become low due to the conditions of the communication line.
- If you connect a device with a built-in radio or tuner to the headset, broadcasts may not be received or the sensitivity may be reduced. Move the headset away from the connected device.
- If the headset connects to the previously connected Bluetooth device, the headset may only establish the HFP/HSP Bluetooth connection when it is turned on. Use the connected device to connect via an A2DP Bluetooth connection.
- When listening to music from a computer on the headset, the sound quality may be poor (e.g., difficult to hear the singer's voice, etc.) for the first few seconds after a connection is established. This is due to the computer specifications (priority on stable connection at the start of transmission and then switches to priority on sound quality several seconds later) and is not a headset malfunction.
If the sound quality does not improve after a few seconds, use the computer to establish an A2DP connection. As for the operations on your computer, refer to the operating instructions supplied with the computer.
- When [Connect to 2 devices simultaneously] is turned on with the "Sony | Headphones Connect" app, LDAC cannot be used. If you want to use LDAC for music playback, turn [Connect to 2 devices simultaneously] off.

Related Topic

- [Listening to music from a device via Bluetooth connection](#)
- [Making a video call on a computer](#)
- [What you can do with the "Sony | Headphones Connect" app](#)
- [Connecting the headset to 2 devices simultaneously \(multipoint connection\)](#)
- [Supported codecs](#)

Wireless Noise Canceling Stereo Headset
WH-1000XM4

Sound skips frequently.

- Set the headset to “Priority on stable connection” mode. For details, see “[About the sound quality mode](#)”.
- Remove any obstacles between the antenna of the connecting Bluetooth device and the built-in antenna of the headset. The antenna of the headset is built into the part shown in the dotted line below.



A: Location of the built-in antenna

- Bluetooth communications may be disabled, or noise or audio dropout may occur under the following conditions.
 - When there is a human body between the headset and the Bluetooth device
In this case, put the Bluetooth device in the same direction as the antenna of the headset to improve the Bluetooth communications.
 - There is an obstacle, such as metal or a wall, between the headset and the Bluetooth device.
 - In places with wireless LAN, where a microwave oven is used, electromagnetic waves are generated, etc.
- The situation may be improved by changing the wireless playback quality settings or fixing the wireless playback mode to SBC on the transmitting device. For details, refer to the operating instructions supplied with the transmitting device.
- Because Bluetooth devices and wireless LAN (IEEE802.11b/g/n) use the same frequency band (2.4 GHz), microwave interference may occur and result in noise, audio dropouts, or communications being disabled if this headset is used near a wireless LAN device. In such a case, perform the following steps.
 - When connecting the headset to a Bluetooth device, use the headset at least 10 m (30 feet) away from the wireless LAN device.
 - If this headset is used within 10 m (30 feet) of a wireless LAN device, turn off the wireless LAN device.
 - Use this headset and the Bluetooth device as near to each other as possible.
- If you are enjoying music with your smartphone, the situation may be improved by shutting down unnecessary apps or restarting your smartphone.
- Connect the headset and the Bluetooth device once again.

Related Topic

- [About the sound quality mode](#)

Wireless Noise Canceling Stereo Headset
WH-1000XM4

The effect of noise canceling is not sufficient.

- Make sure that the noise canceling function is turned on.
 - Adjust the headset into a comfortable position.
 - The noise canceling function is effective in low frequency ranges such as airplanes, trains, offices, near air-conditioning, and is not as effective for higher frequencies, such as human voices.
 - Check that the Adaptive Sound Control is turned off.
Check the setting of the Adaptive Sound Control on the “Sony | Headphones Connect” app. When the Adaptive Sound Control is turned on, the noise canceling function may become insufficient.
-

Related Topic

- [What is noise canceling?](#)
- [Using the noise canceling function](#)
- [Wearing the headset](#)
- [What you can do with the “Sony | Headphones Connect” app](#)

Wireless Noise Canceling Stereo Headset
WH-1000XM4

Pairing cannot be done.

- Bring the headset and the Bluetooth device within 1 m (3 feet) from each other.
 - The headset automatically enters pairing mode when pairing for the first time after purchasing, initializing, or repairing the headset. To pair a second or subsequent device, press and hold the  (power) button of the headset for 7 seconds or more to enter pairing mode.
 - When pairing a device once again after initializing or repairing the headset, you may be unable to pair the device if it retains pairing information for the headset (iPhone or other device). In this case, delete the pairing information for the headset from the device and pair them again.
-

Related Topic

- [How to make a wireless connection to Bluetooth devices](#)
- [Initializing the headset to restore factory settings](#)

One-touch connection (NFC) does not work.

- Keep the smartphone close to the N-mark on the headset until the smartphone responds. If it still does not respond, slowly move the smartphone around in different directions.
 - Check that the NFC function of the smartphone is turned on.
 - If the smartphone is in a case, remove the case.
 - NFC reception sensitivity varies depending on the smartphone. If it repeatedly fails to connect, connect/disconnect on the smartphone.
 - You cannot establish a one-touch connection (NFC) while charging the battery, because the headset cannot be turned on. Finish charging before establishing the one-touch connection (NFC).
 - You cannot establish a one-touch connection (NFC) when the headphone cable is connected to the headphone cable input jack. Remove the headphone cable before establishing the one-touch connection (NFC).
 - Check that the connecting device supports the NFC function.
 - Check that the Bluetooth function of the smartphone is turned on.
-
-

Related Topic

- [One-touch connection \(NFC\) with an Android smartphone](#)

Wireless Noise Canceling Stereo Headset
WH-1000XM4

Unable to make a Bluetooth connection.

- Check that the headset is turned on.
 - Check that the Bluetooth device is turned on and the Bluetooth function is on.
 - If the headset automatically connects to the last connected Bluetooth device, you may fail to connect the headset to other devices via Bluetooth connection. In that case, operate the last connected Bluetooth device and disconnect the Bluetooth connection.
 - Check if the Bluetooth device is in sleep mode. If the device is in sleep mode, cancel the sleep mode.
 - Check if the Bluetooth connection has been terminated. If terminated, make the Bluetooth connection again.
 - If the pairing information for the headset has been deleted on the Bluetooth device, pair the headset with the device again.
-

Related Topic

- [How to make a wireless connection to Bluetooth devices](#)

Wireless Noise Canceling Stereo Headset
WH-1000XM4

Distorted sound

- Keep the headset away from a microwave oven, wireless LAN device, etc.

5-013-731-11(4) Copyright 2020 Sony Corporation

The headset does not operate properly.

- You cannot operate the touch sensor control panel when not wearing the headset. Wear the headset and operate the touch sensor control panel.
 - When you wear the headset with your face up or down, or when you wear the headset upside down, wearing detection may not work properly, and the touch sensor control panel and CUSTOM button may not be available for operation. Wear the headset correctly while facing forward, or press the  (power) button briefly.
 - When you wear the headset over a cap, a scarf, hair, etc., wearing detection may not work properly, and the touch sensor control panel may not be available for operation. Wear the headset so that your ears are inside the earpads.
 - Reset the headset. This operation does not delete pairing information.
 - If the headset does not operate properly even if you reset the headset, initialize the headset.
-

Related Topic

- [Wearing the headset](#)
- [Resetting the headset](#)
- [Initializing the headset to restore factory settings](#)

Wireless Noise Canceling Stereo Headset
WH-1000XM4

Cannot hear a person on a call.

- Check that both the headset and the connected device (i.e., smartphone) are turned on.
 - Turn up the volume of the connected device and the volume of the headset if they are too low.
 - Check the audio settings of the Bluetooth device to make sure the sound is output from the headset during a call.
 - Use the Bluetooth device to re-establish the connection. Select HFP or HSP for the profile.
 - If you are listening to music with the headset, stop playback and tap the touch sensor control panel twice quickly (with an interval of about 0.4 seconds) to respond to an incoming call.
-

Related Topic

- [How to make a wireless connection to Bluetooth devices](#)
- [Receiving a call](#)
- [Making a call](#)

Wireless Noise Canceling Stereo Headset
WH-1000XM4

Low voice from callers

- Turn up the volume of the headset and the connected device.

5-013-731-11(4) Copyright 2020 Sony Corporation

The touch sensor control panel does not respond correctly

- The sensor of the touch sensor control panel is built into the flat surface of the right unit. Operate within the range of the sensor.

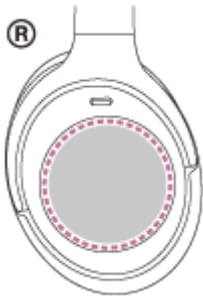

- When you swipe your finger forward/backward or up/down on the touch sensor control panel, the touch sensor control panel may not work correctly depending on the angle at which the headset is worn or the direction your head is facing.
 - When you swipe your finger forward/backward, make the movements perpendicular to the headband.



- When you swipe your finger up/down, make the movements parallel to the headband.



Wireless Noise Canceling Stereo Headset
WH-1000XM4

Resetting the headset

If the headset cannot be turned on or cannot be operated even when it is turned on, press both the  (power) button and the CUSTOM button simultaneously while charging. The headset will be reset. The device registration (pairing) information is not deleted.

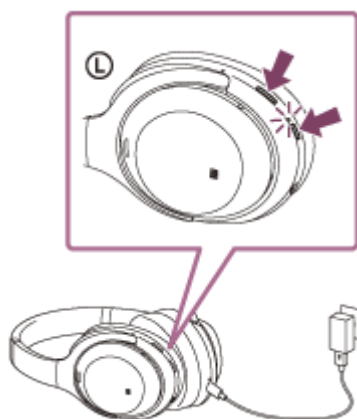

If the headset does not operate correctly even after resetting, initialize the headset to restore factory settings.

Related Topic





- [Initializing the headset to restore factory settings](#)

Wireless Noise Canceling Stereo Headset
WH-1000XM4

Initializing the headset to restore factory settings

If the headset does not operate correctly even after resetting, initialize the headset.

Turn off the headset while the USB Type-C cable is disconnected and then press and hold the  (power) button and the CUSTOM button simultaneously for 7 seconds or more.

The indicator (blue) flashes 4 times (   ), and the headset is initialized. This operation resets volume settings, etc. to the factory settings, and deletes all pairing information. In this case, delete the pairing information for the headset from the device and then pair them again.

If the headset does not operate correctly even after initializing, consult your nearest Sony dealer.

Note

- If you have updated the software after purchasing the headset, even if you initialize the headset, the software is retained updated.
- When you initialize the headset to restore the factory settings after you change the language of the voice guidance, the language will also return to the factory setting.