



# RAZER NOMMO PRO

MASTER GUIDE

The Razer Nommo Pro 2.1 Certified by THX produces power and clarity for an audio experience that's immersive and lifelike. Experience silk-woven 20mm tweeters for smooth highs, Kevlar® coated 77mm full range drivers for big, tight sound, a dedicated 152mm down-firing subwoofer for powerful bass and Dolby Virtual Surround Sound technology.

# CONTENTS

1. PACKAGE CONTENTS / SYSTEM REQUIREMENTS.....	4
2. REGISTRATION / TECHNICAL SUPPORT.....	5
3. TECHNICAL SPECIFICATIONS.....	6
4. DEVICE LAYOUT.....	7
5. SETTING UP YOUR RAZER NOMMO PRO .....	8
6. USING YOUR RAZER NOMMO PRO .....	13
7. INSTALLING RAZER SOFTWARE FOR YOUR RAZER NOMMO PRO.....	15
8. CONFIGURING YOUR RAZER NOMMO PRO .....	16
9. SAFETY AND MAINTENANCE.....	24
10. LEGALESE.....	25

---

# 1. PACKAGE CONTENTS / SYSTEM REQUIREMENTS

## PACKAGE CONTENTS

- Razer Nommo Pro 2.1 gaming speakers
  - 2x full range speakers
  - 7-inch subwoofer
  - Audio control pod
- Optical cable
- 3.5mm audio cable
- Power cord\*
- Important Product Information Guide

*\*May vary for specific regions*

## SYSTEM REQUIREMENTS

### HARDWARE REQUIREMENTS

- PC/Mac with a free USB port
- Devices with optical output capability
- Devices with 3.5mm output capability
- Device with Bluetooth connectivity

### RAZER SYNAPSE 3 REQUIREMENTS

- Windows® 7 (or higher)
- Internet connection
- 500 MB of free hard disk space

### RAZER SYNAPSE REQUIREMENTS

- OS X 10.9 (or higher)
- Internet connection
- 100 MB of free hard disk space

---

## 2. REGISTRATION / TECHNICAL SUPPORT

### REGISTRATION

Register your product online at [razerid.razer.com/warranty](https://razerid.razer.com/warranty) to get real-time information on your product's warranty status.

If you haven't registered for a Razer ID yet, register now at [razerid.razer.com](https://razerid.razer.com) to get a wide range of Razer benefits.

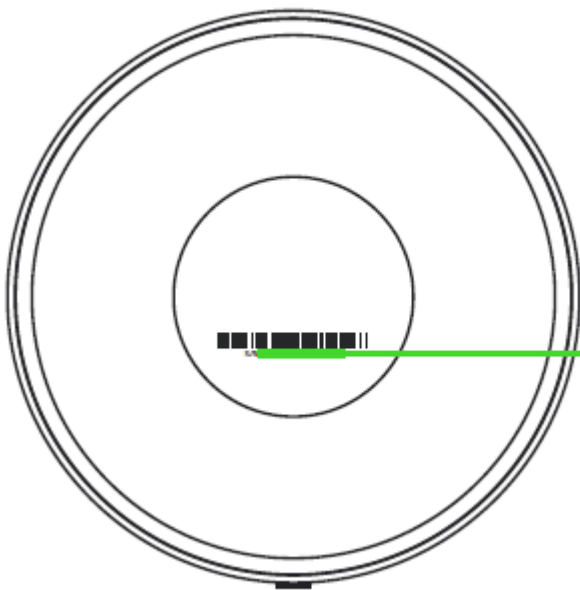

*Your product's serial number  
can be found here.*

### TECHNICAL SUPPORT

- 1 year limited manufacturer's warranty.
- Free online technical support at [support.razer.com](https://support.razer.com).

---

## 3. TECHNICAL SPECIFICATIONS

### TECHNICAL SPECIFICATIONS

- 2 x 0.8-inch silk dome tweeters (1 x per speaker)
- 2 x 3-inch full range drivers (1 x per speaker)
- 1 x downward firing subwoofer
- Frequency response: 35-20,000hz
- USB connection
- Bluetooth 4.2 connection
- Optical connection
- 3.5mm connection
- Control pod featuring power, volume, mute, pairing and source control functions
- Razer Chroma™ enabled

## 4. DEVICE LAYOUT

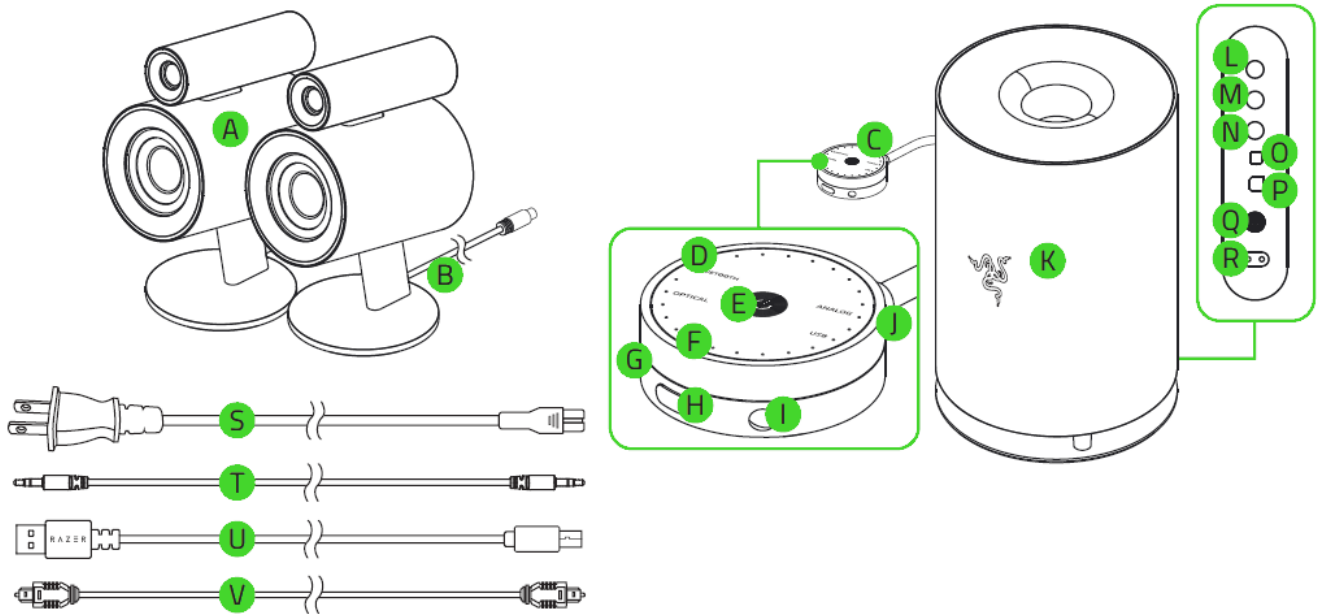

- A. 2x full range speakers
- B. Speakers to subwoofer cables
- C. Audio control pod
- D. Audio source indicator
- E. Standby button
- F. LED indicator
- G. headphone output port
- H. Audio source button
- I. 3.5mm audio input port
- J. Volume control
- K. Subwoofer
- L. Left speaker port
- M. Right speaker port
- N. Audio control pod port
- O. Optical input port
- P. USB Type-B port
- Q. Power button
- R. Power port
- S. Power cord
- T. 3.5mm audio cable
- U. USB Type-A to USB Type-B cable
- V. Optical cable

---

## 5. SETTING UP YOUR RAZER NOMMO PRO

### SETTING UP YOUR RAZER NOMMO PRO

1. Arrange your chair and your Razer Nommo Pro in a triangular position, preferably with all sides at an equal distance.

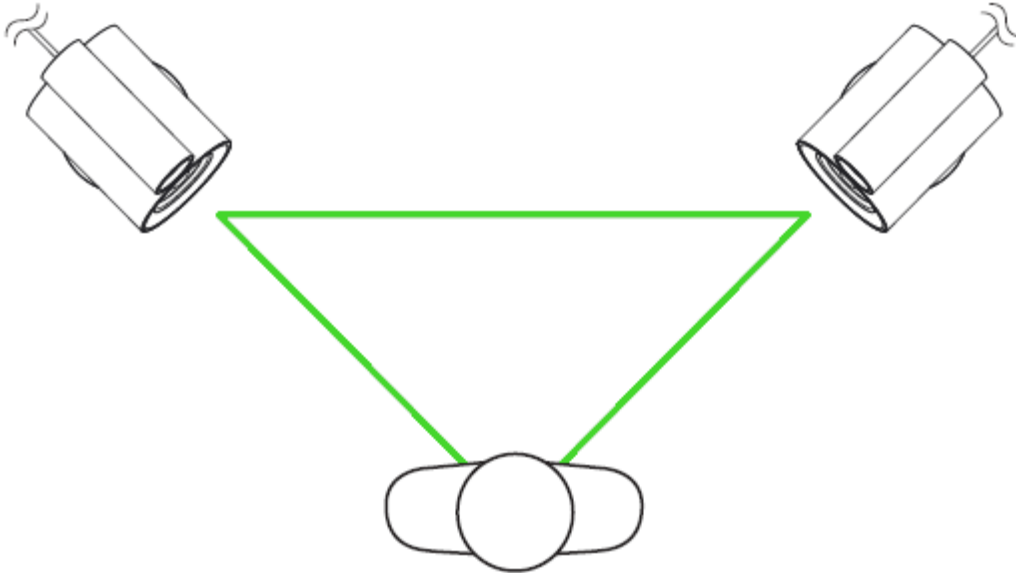

2. Plug the left and right speakers to their respective speaker ports on the subwoofer.

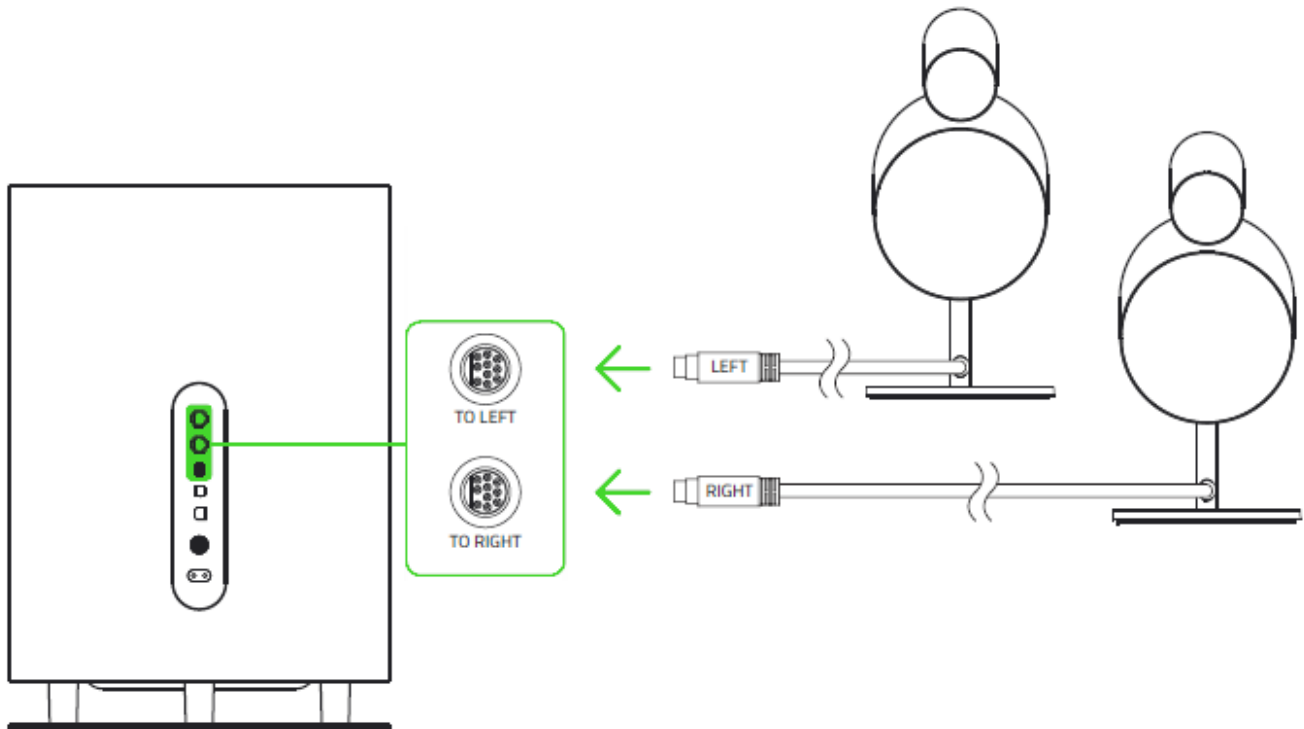

3. Plug the audio control pod to the subwoofer.

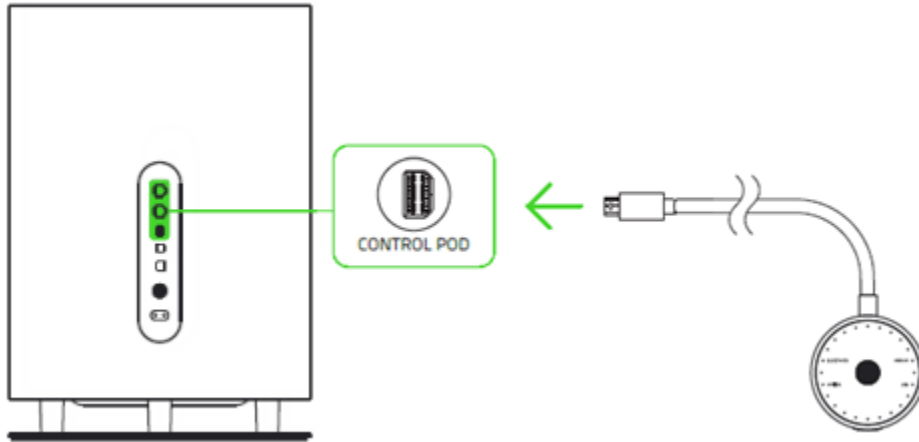

4. Plug the power cord\* from your subwoofer to an appropriate power source.

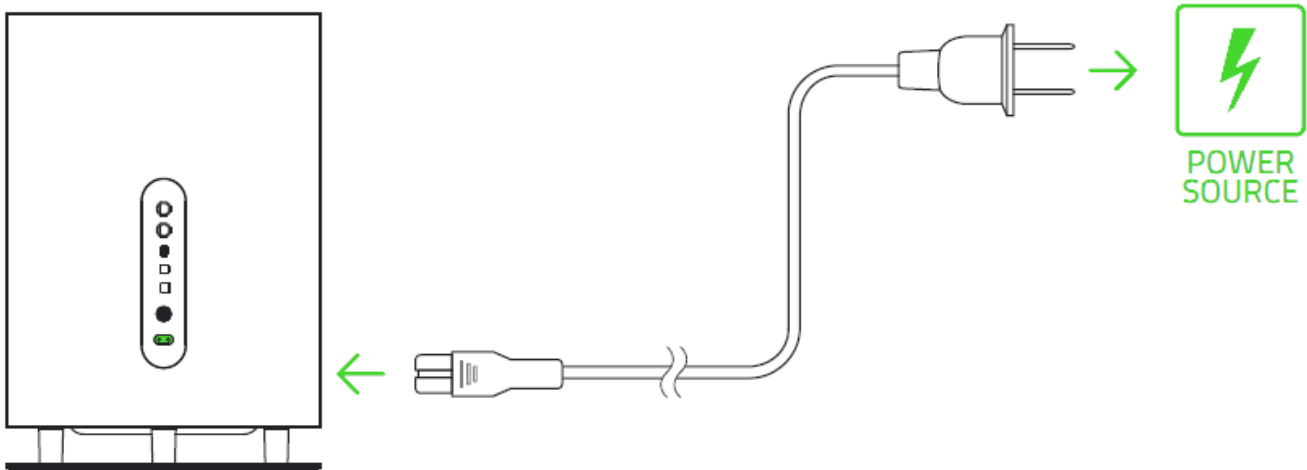

*\*Use the appropriate power cord for your region.*

5. Fully press the power button on the subwoofer until you hear a click; and then press the standby button on the control pod to disable standby mode.

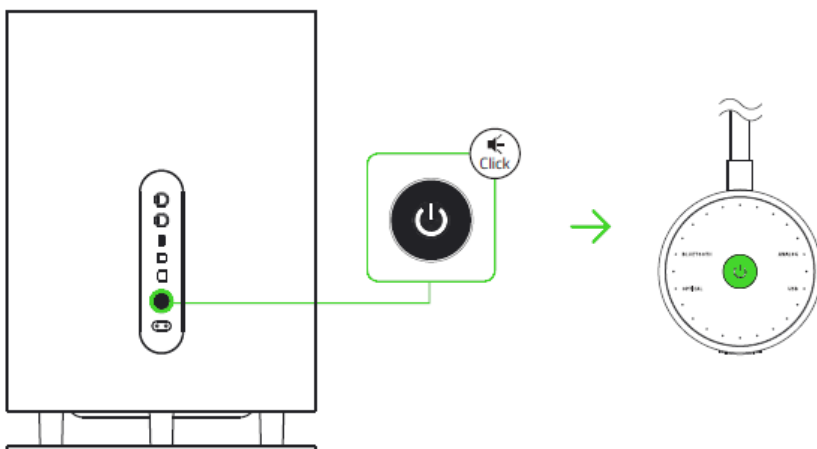

## CONNECTING YOUR RAZER NOMMO PRO TO AUDIO DEVICES

### VIA 3.5MM AUDIO PORT

Plug your portable music player to your Razer Nommo Pro using the included 3.5mm audio cable.

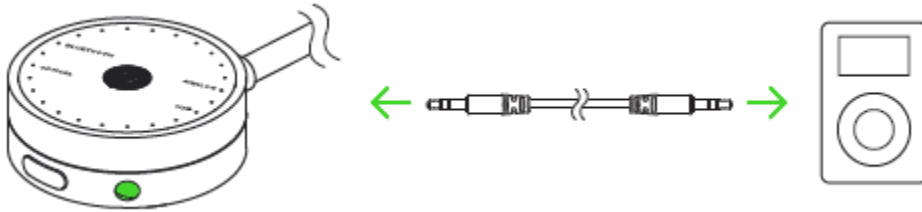

### VIA OPTICAL PORT

Plug your home entertainment system to your Razer Nommo Pro using the included optical cable.

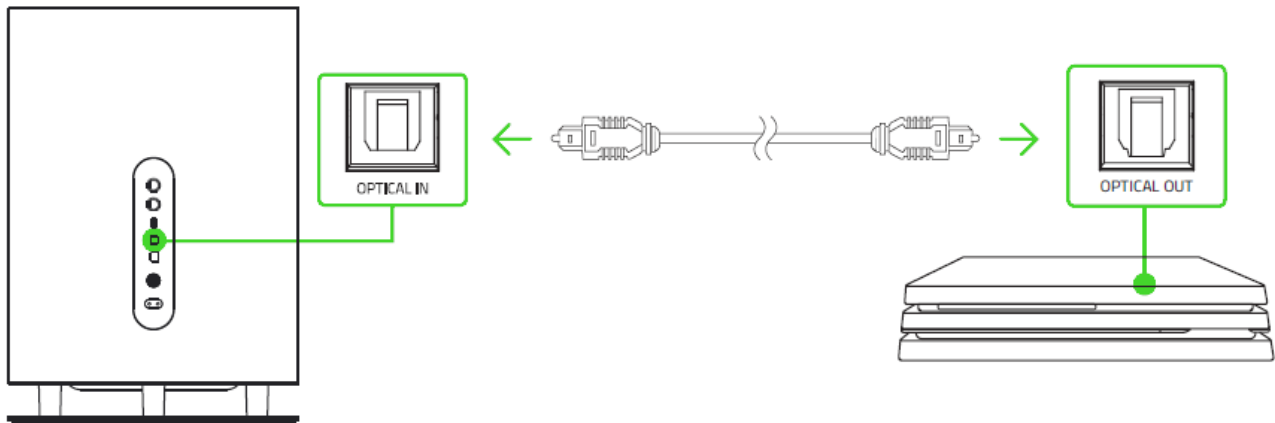

### VIA BLUETOOTH

1. Download the app on your mobile device.



2. While the control pod is enabled, press the audio source button until Bluetooth is selected.

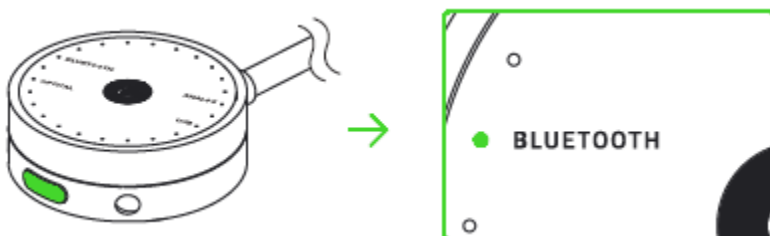

3. Press and hold the audio source button until the LED indicator starts to blink.

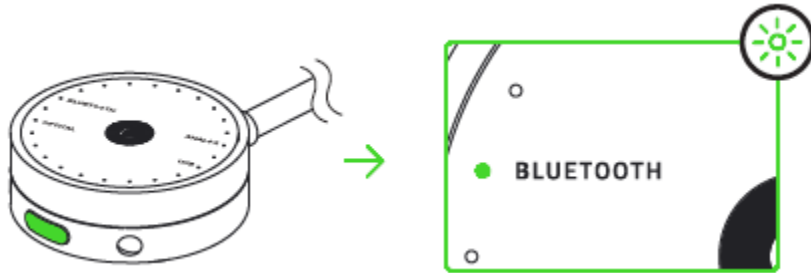

4. Launch the app and follow the onscreen instructions. Download the Nommo Pro at [razer.com/Nommoproapp](https://www.razer.com/Nommoproapp).

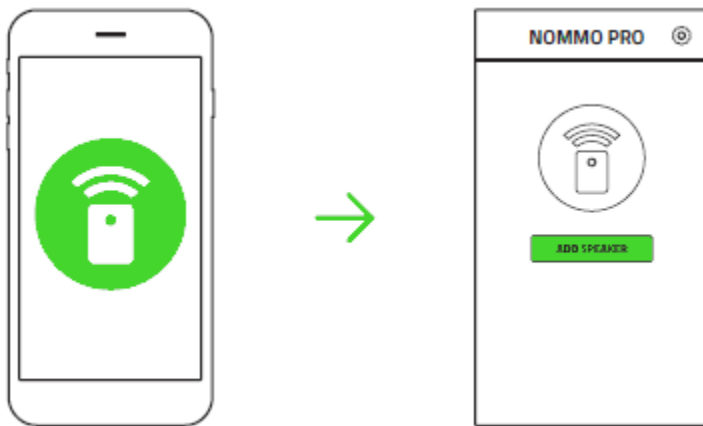

### VIA USB PORT

Plug your PC or Mac to your Razer Nommo Pro using the USB Type-A to USB Type-B cable. If you are using the Razer Nommo Pro for the first time, you may be required to set up the device as your system's default playback device.

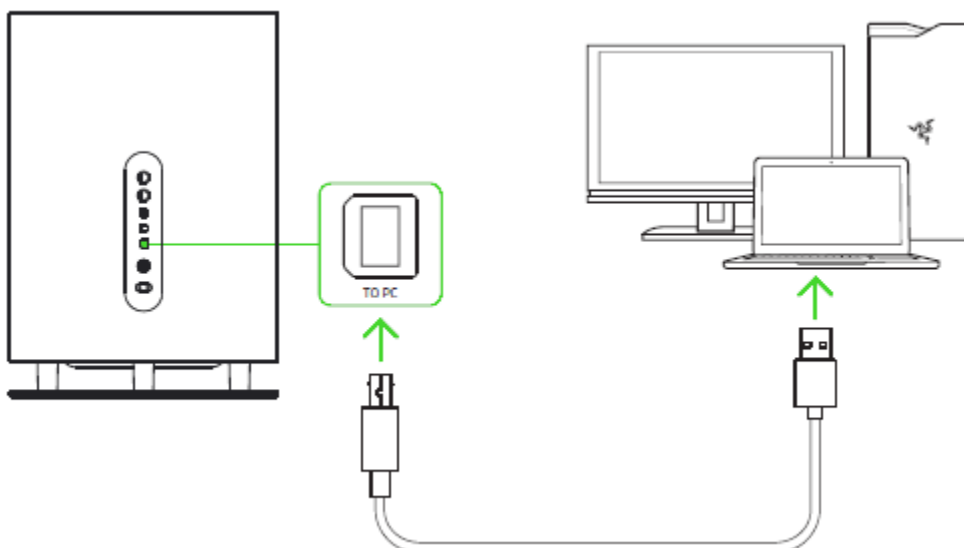

### FOR PC USERS

Step 1: Open your **Sound** settings from **Control Panel > Hardware and Sound > Manage audio devices**. You can also right-click your sound icon on the system tray and select **Playback devices**.

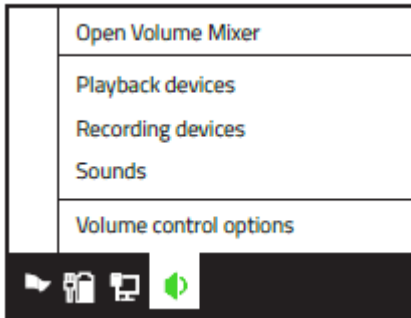

Step 2: In the **Playback** tab, select Razer Nommo Pro from the list and click the **Set Default** button.

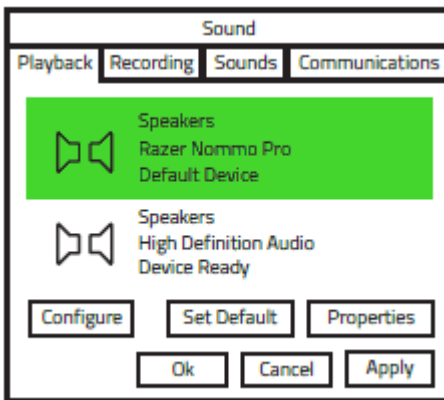

### FOR MAC USERS

Step 1: Open your **Sound** settings from **System Preferences > Sound**.

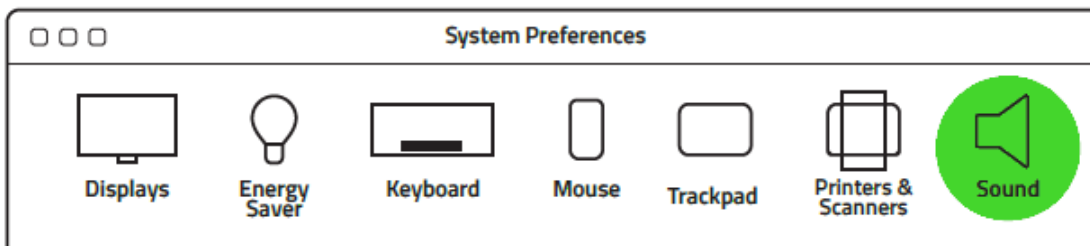

Step 2: In the **Output** tab, select Razer Nommo Pro from the list.

Name	Type
Headphones	Built-in Output
Line Out	Built-in Line Output
<b>Razer Nommo Pro</b>	<b>USB</b>

## 6. USING YOUR RAZER NOMMO PRO

### USING THE STANDBY MODE

Press and hold the standby button on the control pod to enable or disable standby mode.

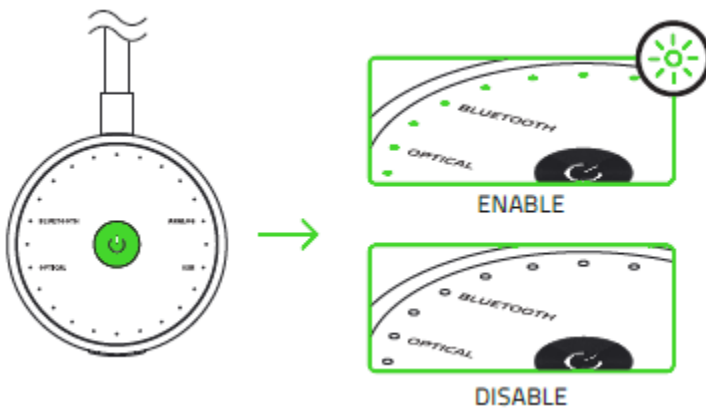

### CHOOSING A PLAYBACK DEVICE

Simply press the audio source button repeatedly until your desired input is selected.

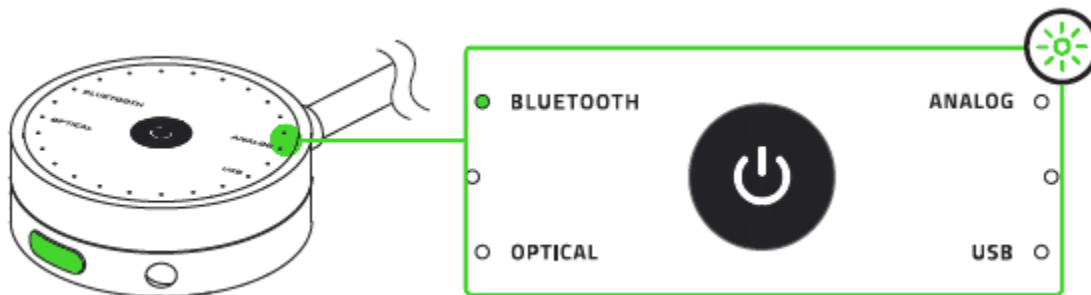

## ADJUSTING THE VOLUME

While powered on, rotate the volume control to increase or decrease the volume.



Press the standby button to mute/unmute the volume.

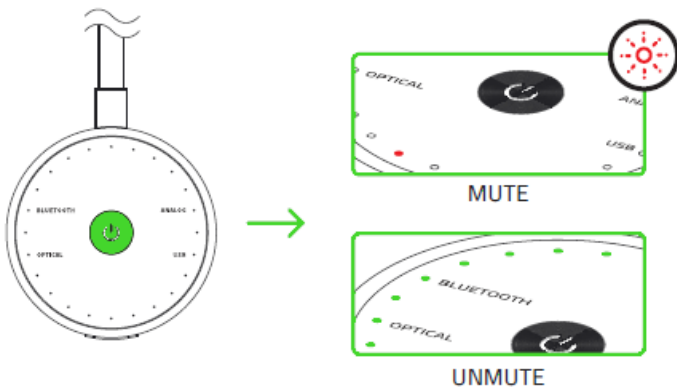

These functions also work on the headphone that is connected to your Razer Nommo Pro.

## USING THE HEADPHONE OUTPUT PORT

While powered on, connect your headphone to the headphone output port of your Razer Nommo Pro. *Note: The sound output will automatically switch from the speakers to the headphones.*

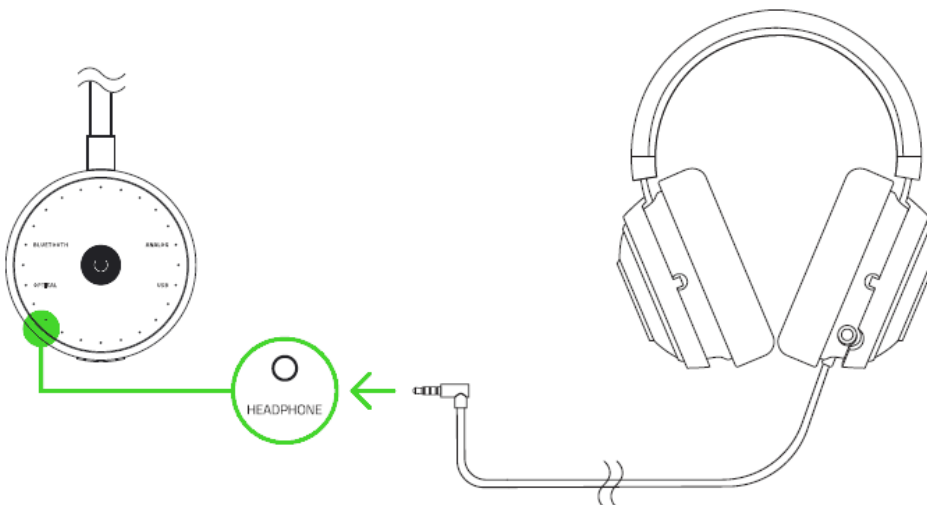

---

## 7. INSTALLING RAZER SOFTWARE FOR YOUR RAZER NOMMO PRO

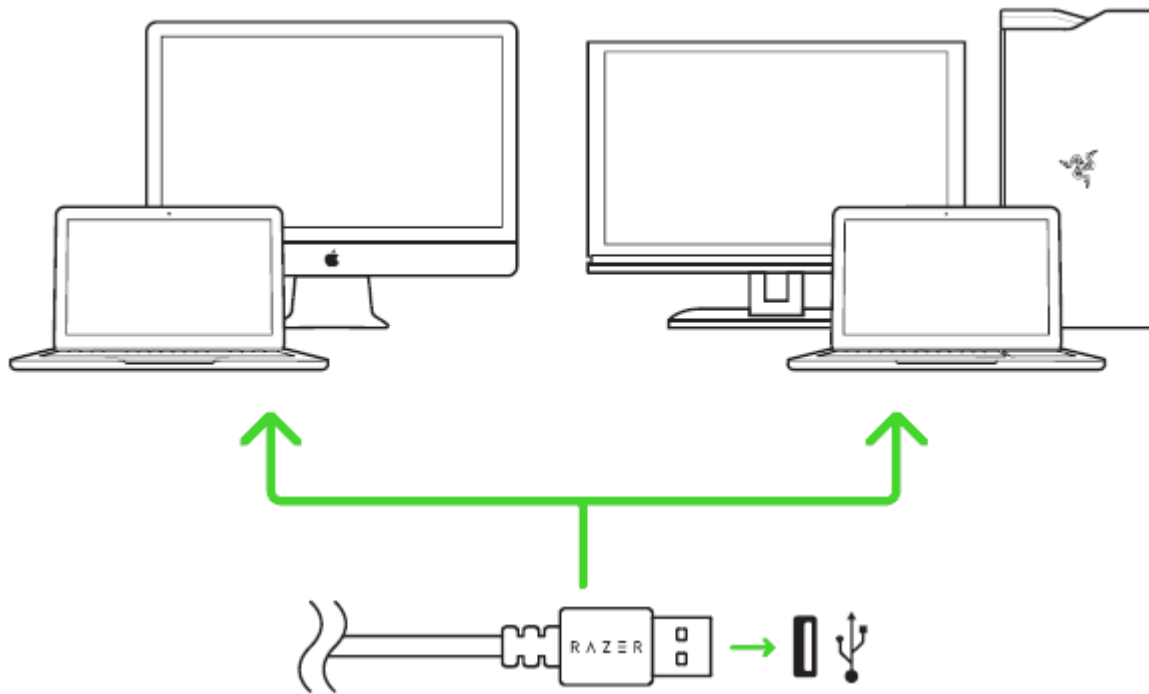

Step 1: Make sure your Razer device is connected to the USB port of your computer.

Step 2: Install the Razer software when prompted\* or download the installer from [razer.com/software](https://razer.com/software).

Step 3: Create your Razer ID or log in using an existing account.

*\*Applicable for Windows 8 or later.*

---

## 8. CONFIGURING YOUR RAZER NOMMO PRO

*Disclaimer: The features listed here require you to log in to Razer Synapse. These features are also subject to change based on the current software version and your Operating System.*

### SYNAPSE TAB

The Synapse tab is your default tab when you first launch Razer Synapse 3. This tab allows you to navigate the Dashboard subtab.

### Dashboard

The Dashboard subtab is an overview of your Razer Synapse 3 where you can access all your Razer devices, modules, and online services.

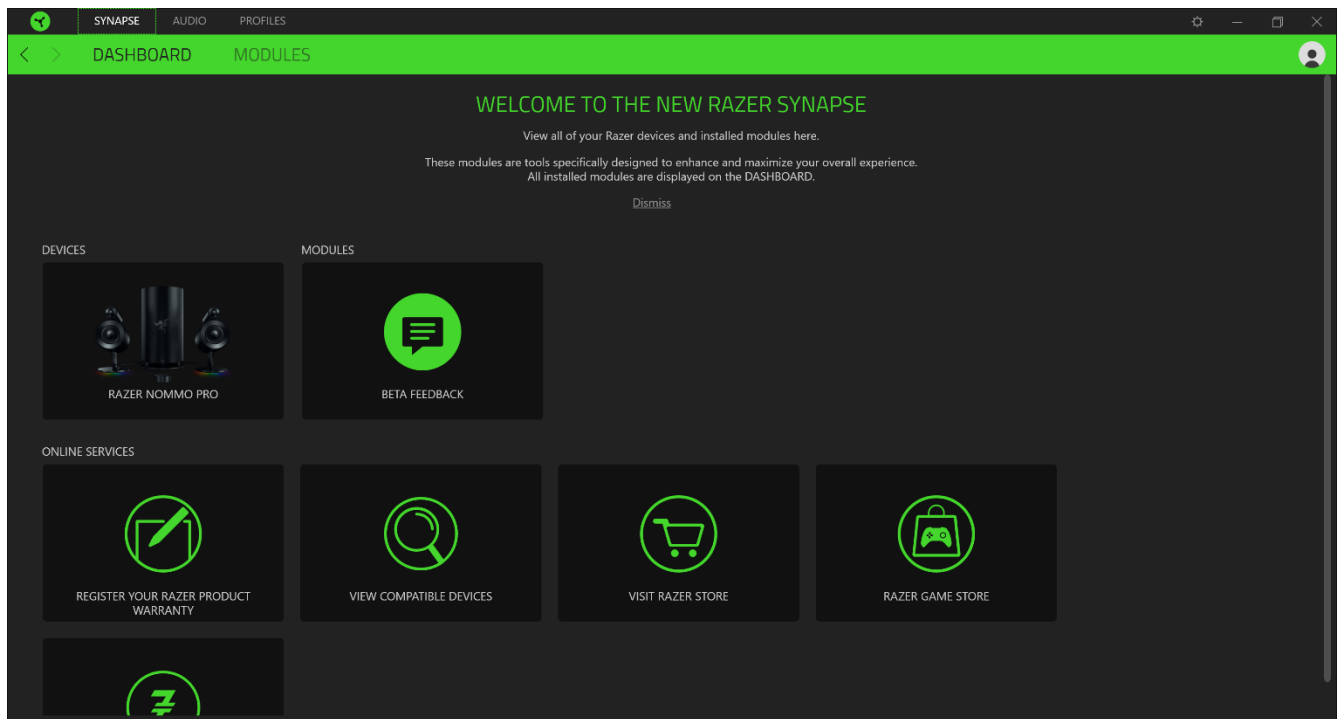

## AUDIO TAB

The Audio tab is the main tab for your Razer Nommo Pro. From here, you can customize your device's settings to unleash its full potential. Changes made under this tab are automatically saved to your system and cloud storage.

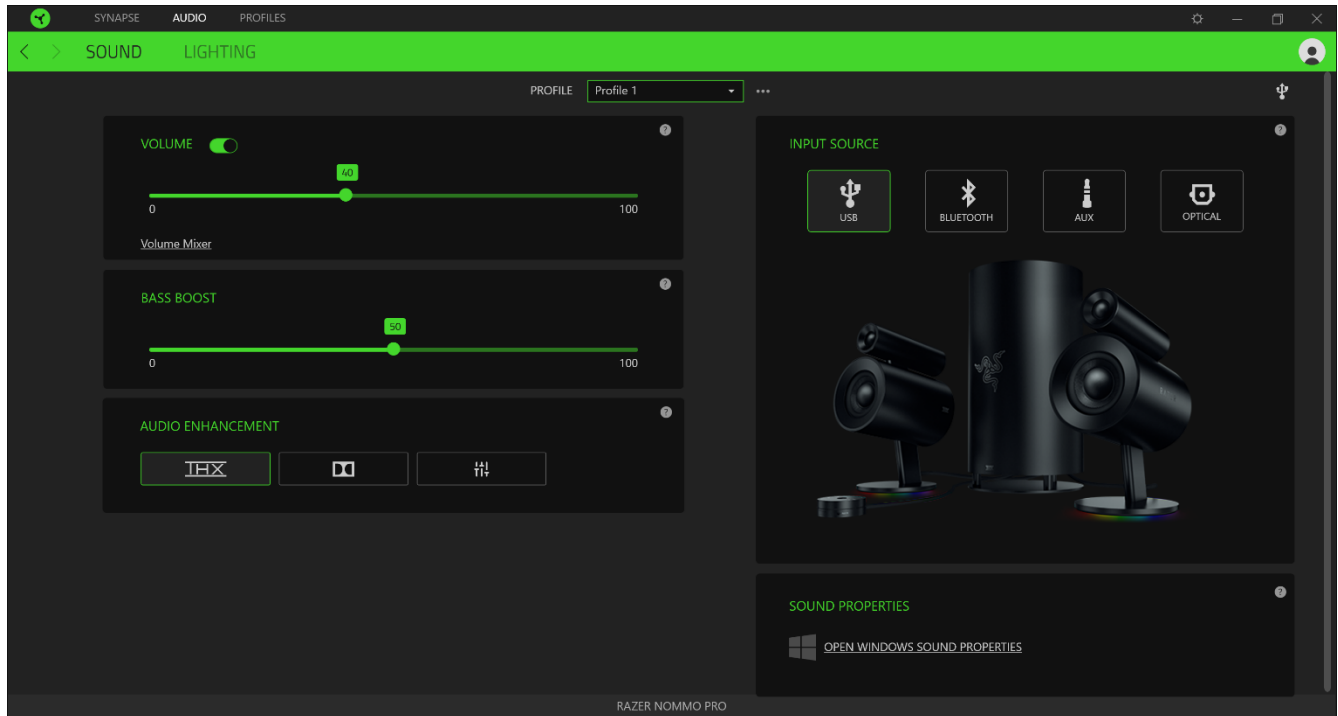

## Sound

The Sound subtab is for modifying your device's volume, equalizer presets, and sound properties.

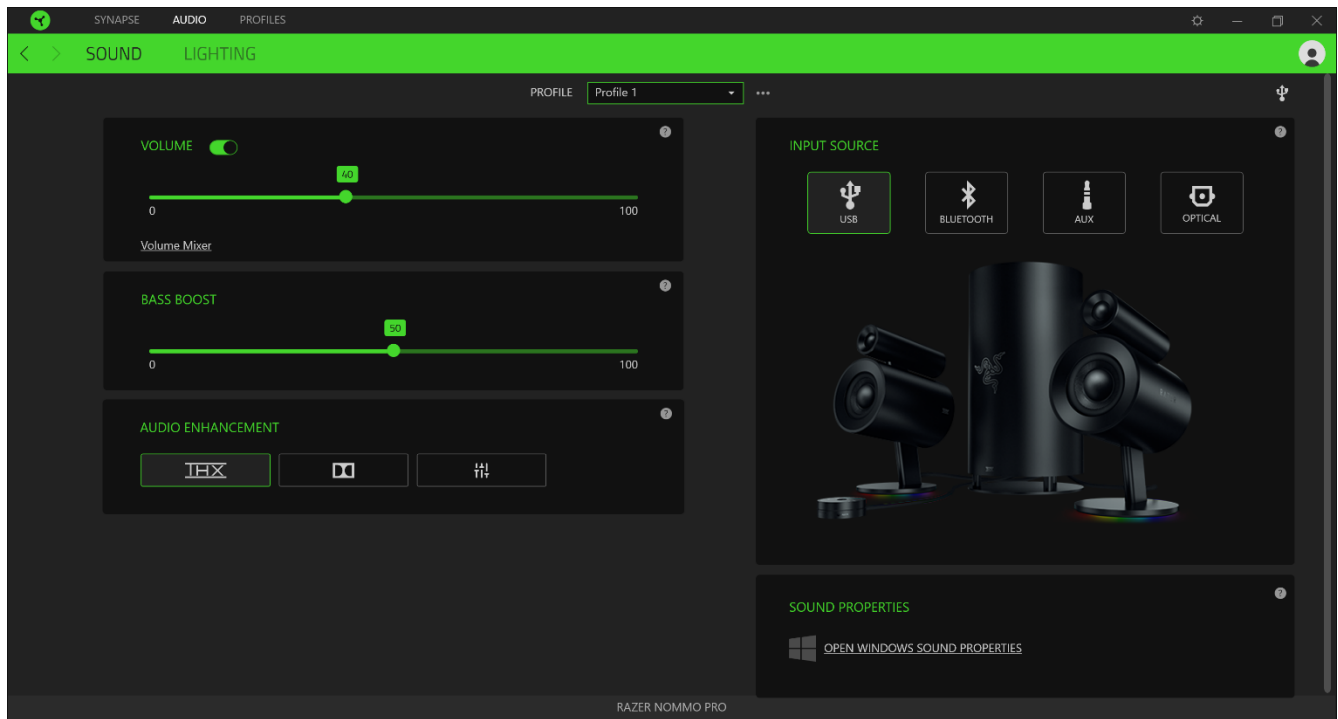

### *Profile*

Profile is a data storage for keeping all your Razer peripheral's settings. By default, the profile name is based on your system's name. To add, rename, duplicate, or delete a profile, simply press the Miscellaneous button ( ●●● ).

### *Volume*

Volume enables you to mute, increase, or decrease the audio output settings.

### *Bass Boost*

Bass Boost allows you to improve the bass output of your speaker system.

### *Audio Enhancement*

Audio Enhancement gives you a selection of audio frequency settings to change the overall tone of your audio output or create your own sound signature by using the equalizer option.

### *Input Source*

Input Source enables you to select between USB, Bluetooth, AUX, and Optical as the sound source.

### *Sound Properties*

Clicking the link will launch the Windows sound properties window.

## Lighting

The Lighting subtab enables you to modify your Razer device's light settings.

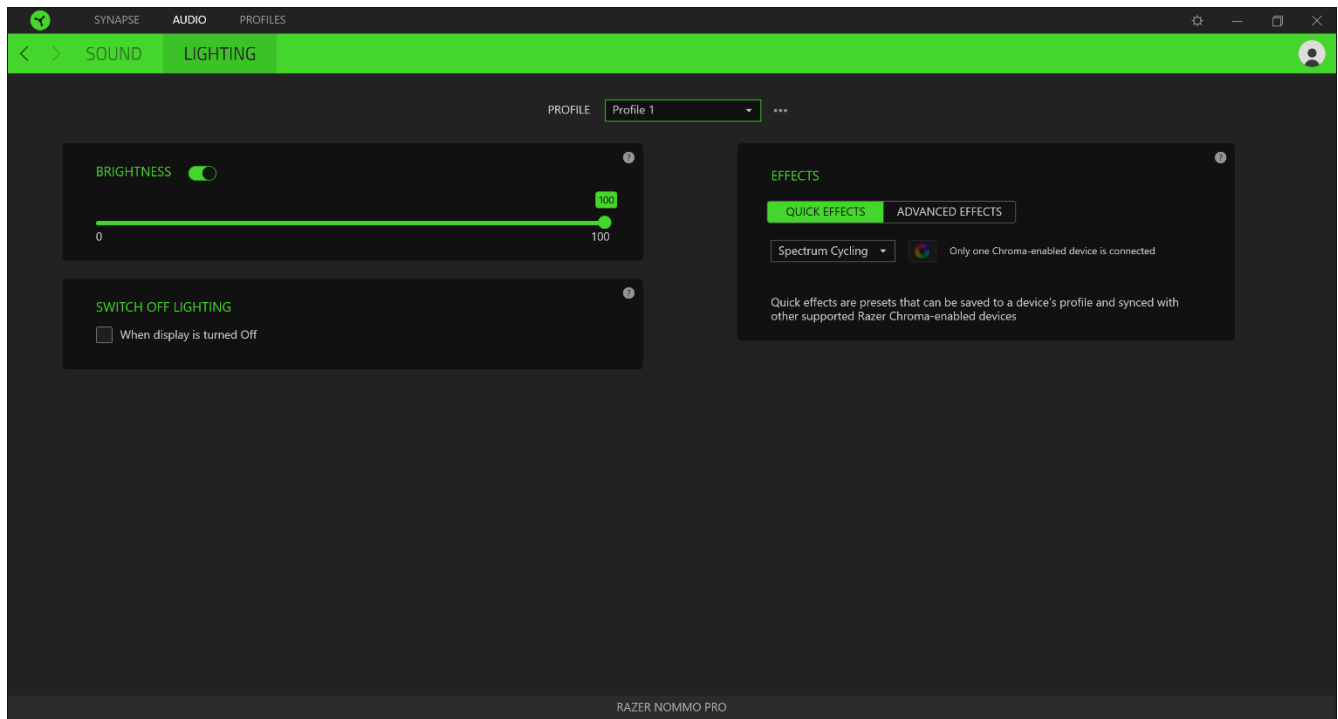

### Brightness



You can turn off your Razer device's lighting by toggling the Brightness option or increase/decrease the luminance using the slider.

### Switch Off Lighting

This is a power saving tool which allows you to disable your device's lighting in response to your system's display turning off.

### Quick Effects

A number of quick effects can be selected and applied to your mouse's lighting, as listed here:

	Name	Description	How to set up
	Breathing	The lighting fades in and out of the selected color(s)	Select up to 2 colors or randomize
	Spectrum Cycling	The LEDs will cycle between 16.8 million colors indefinitely	No further customization required

	Static	The LEDs will remain lit in the selected color	Select a color
	Wave	The lighting will scroll in the direction selected with a default spectrum of colors	Select either left-to-right or right-to-left wave direction

If you have other supported Razer Chroma-enabled devices, you can synchronize their quick effects with your Razer device by clicking the Chroma Sync button (  ).

### *Advanced Effects*

The Advanced Effects option allows you to choose a Chroma Effect you want to use on your Razer Chroma-enabled peripheral.

## PROFILES TAB

The Profiles tab is a convenient way of managing all your profiles and linking them to your games and applications.

### Devices

View which Razer device is using a specific profile using the Devices subtab. To create a new profile within the selected device, simply click the add button ( + ). To rename, duplicate, or delete a profile, simply press the Miscellaneous button ( ●●● ). Each profile can be set to automatically activate when you run an application using the Link Games option.

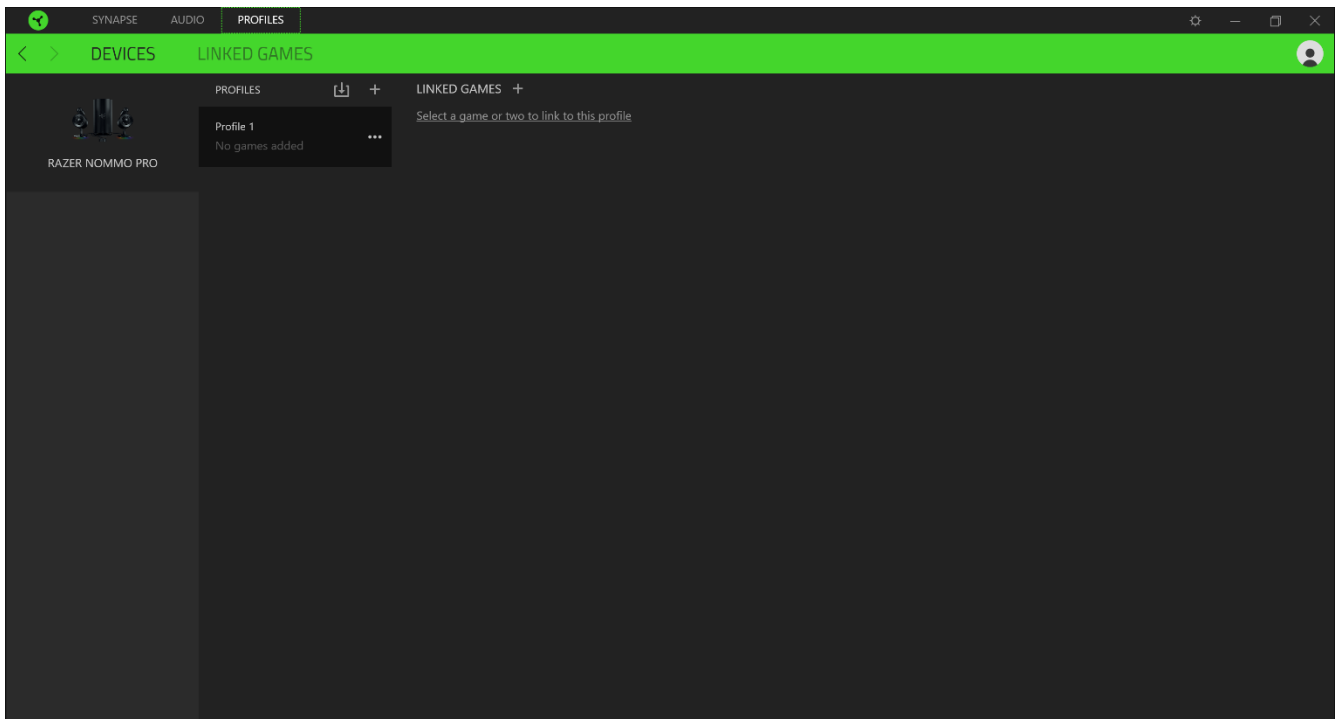

## Linked Games

The Linked Games subtab gives you the flexibility to add games, view peripherals that are linked to games, or search for added games. You can also sort games based on alphabetical order, last played, or most played. Added games will still be listed here even if it is not linked to a Razer device.

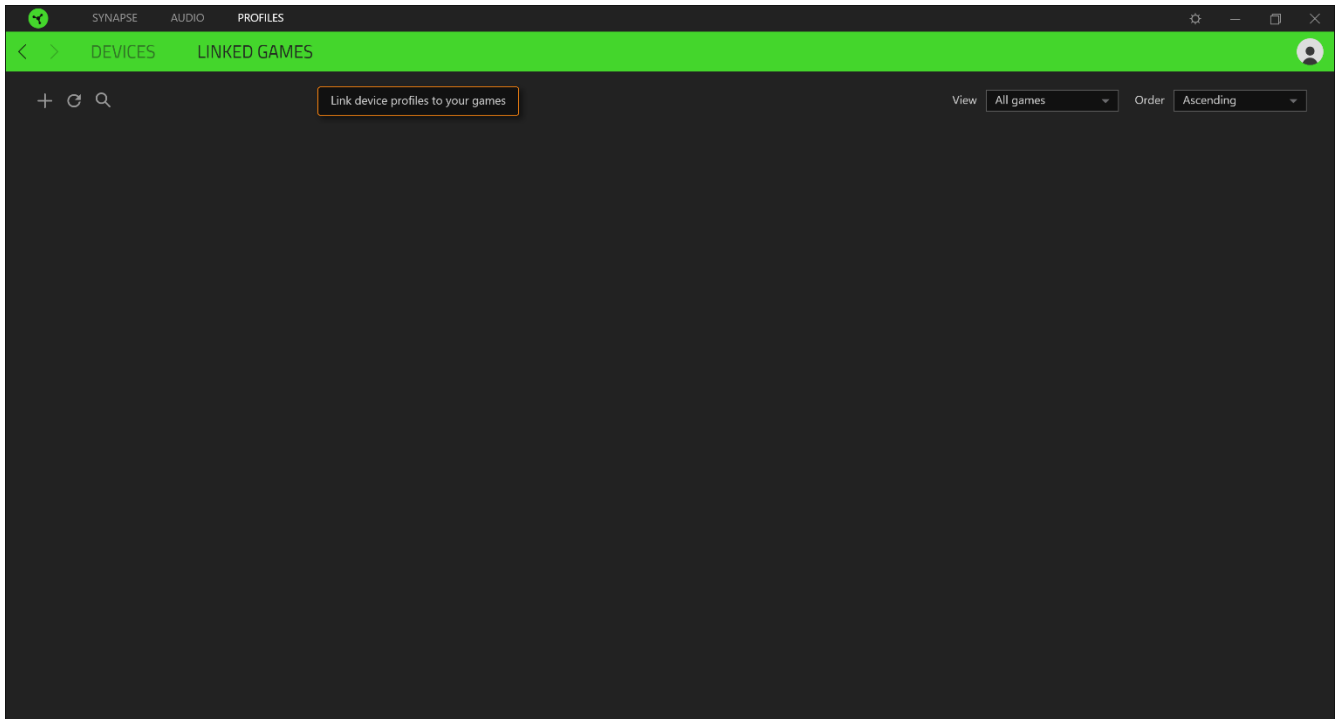

## SETTINGS WINDOW

The Settings window, accessible by clicking the (⚙️) button on Razer Synapse 3, enables you to configure the startup behavior, change language, view your Razer device's master guide, or perform factory reset on any connected Razer device.

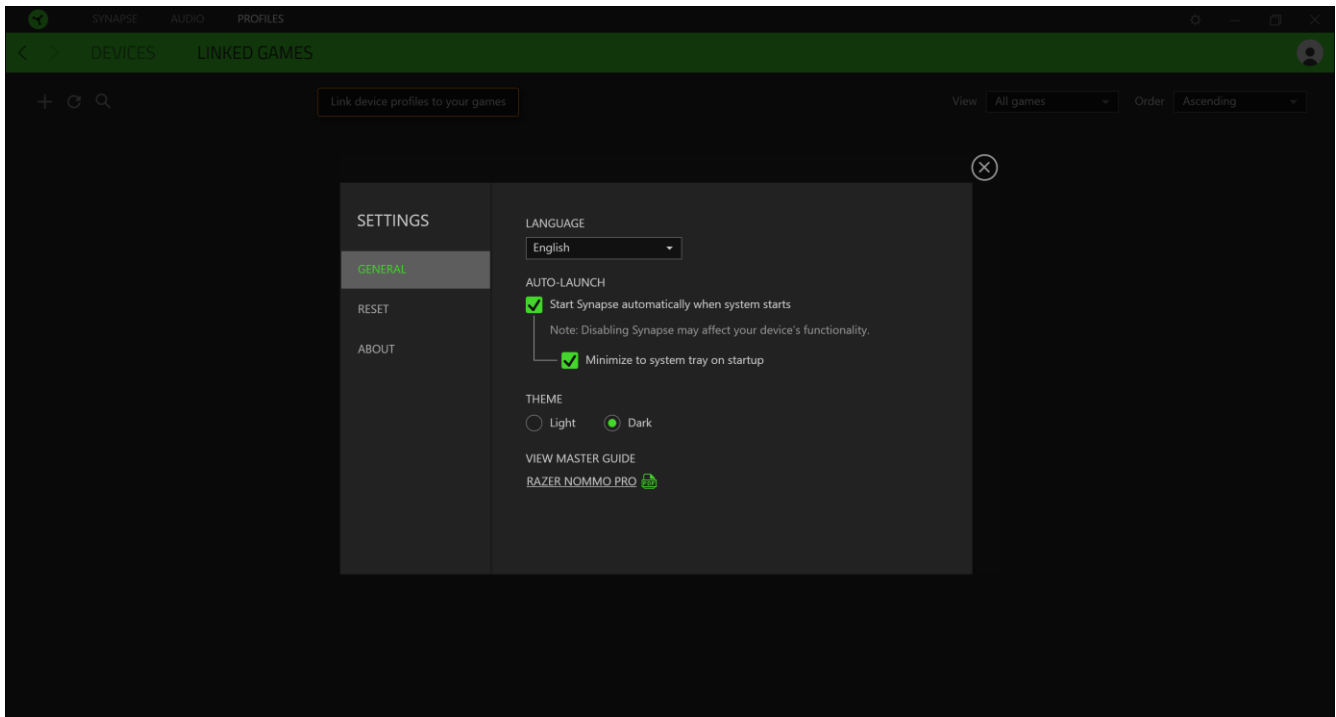

### General tab

The default tab of the Settings window, The General tab enables you to change the software's display language and start-up behavior, or view the master guide of all connected Razer devices.

### Reset tab

The Reset tab allows you to perform a factory reset on all connected Razer devices with on-board memory. All profiles stored on the selected device's on-board memory will be erased.

*Note: Performing a factory reset on devices without on-board memory will only create a new profile for your device on Razer Synapse 3 using the default settings.*

### About tab

The About tab displays brief software information, its copyright statement, and also provides relevant links for its terms of use. You may also use this tab to check for software updates, or as a quick access to Razer's social communities.

---

## 9. SAFETY AND MAINTENANCE

### SAFETY GUIDELINES

In order to achieve maximum safety while using your Razer Nommo Pro, we suggest that you adopt the following guidelines:

Should you have trouble operating the device properly and troubleshooting does not work, unplug the device and contact the Razer hotline or go to [support.razer.com](https://support.razer.com) for support.

Do not take apart the device (doing so will void your warranty) and do not attempt to operate it under abnormal current loads.

Keep the device away from liquid, humidity or moisture. Operate the device only within the specific temperature range of 0°C (32°F) to 40°C (104°F). Should the temperature exceed this range, unplug and/or switch off the device in order to let the temperature stabilize to an optimal level.

Listening to excessively loud volumes over extended periods of time can damage your hearing. Furthermore, legislation of certain countries permits a maximum sound level of 86db to affect your hearing for 8 hours a day. We therefore recommend that you reduce the volume to a comfortable level when listening for prolonged periods of time. Please, take good care of your hearing.

### MAINTENANCE AND USE

The Razer Nommo Pro requires minimum maintenance to keep it in optimum condition. Once a month we recommend you unplug the device from the computer and clean it using a soft cloth or cotton swab with a bit of warm water to prevent dirt buildup. Do not use soap or harsh cleaning agents.

---

## 10. LEGALESE

### **COPYRIGHT AND INTELLECTUAL PROPERTY INFORMATION**

©2018 Razer Inc. All rights reserved. Razer, the triple-headed snake logo, Razer logo, “For Gamers. By Gamers.”, and “Powered by Razer Chroma” logo are trademarks or registered trademarks of Razer Inc. and/or affiliated companies in the United States or other countries. All other trademarks and trade names are the property of their respective owners and other company and product names mentioned herein may be trademarks of their respective companies.

Windows and the Windows logo are trademarks or registered trademarks of the Microsoft group of companies.

Mac OS, Mac and the Mac logo are trademarks or registered trademarks of Apple.

THX and the THX logo are trademarks of THX Ltd., registered in the U.S. and other countries.

Razer Inc. (“Razer”) may have copyright, trademarks, trade secrets, patents, patent applications, or other intellectual property rights (whether registered or unregistered) concerning the product in this guide. Furnishing of this guide does not give you a license to any such copyright, trademark, patent or other intellectual property right. The Razer Nommo Pro (the “Product”) may differ from pictures whether on packaging or otherwise. Razer assumes no responsibility for such differences or for any errors that may appear. Information contained herein is subject to change without notice.

### **LIMITED PRODUCT WARRANTY**

For the latest and current terms of the Limited Product Warranty, please visit [razer.com/warranty](https://www.razer.com/warranty).

### **LIMITATION OF LIABILITY**

Razer shall in no event be liable for any lost profits, loss of information or data, special, incidental, indirect, punitive or consequential or incidental damages, arising in any way out of distribution of, sale of, resale of, use of, or inability to use the Product. In no event shall Razer’s liability exceed the retail purchase price of the Product.

## **GENERAL**

These terms shall be governed by and construed under the laws of the jurisdiction in which the Product was purchased. If any term herein is held to be invalid or unenforceable, then such term (in so far as it is invalid or unenforceable) shall be given no effect and deemed to be excluded without invalidating any of the remaining terms. Razer reserves the right to amend any term at any time without notice.