

Ikarao®

Break X1

Smart Karaoke Speaker

User Manual **EN**

Introduction:

Thank you for your purchase of this product. Be sure that you have read this manual and understood its contents before using the product. Keep the manual where it will be read by all who use the product.

For the Latest Information

The latest versions of the manuals are available from:
<https://www.ikarao.com/pages/support>

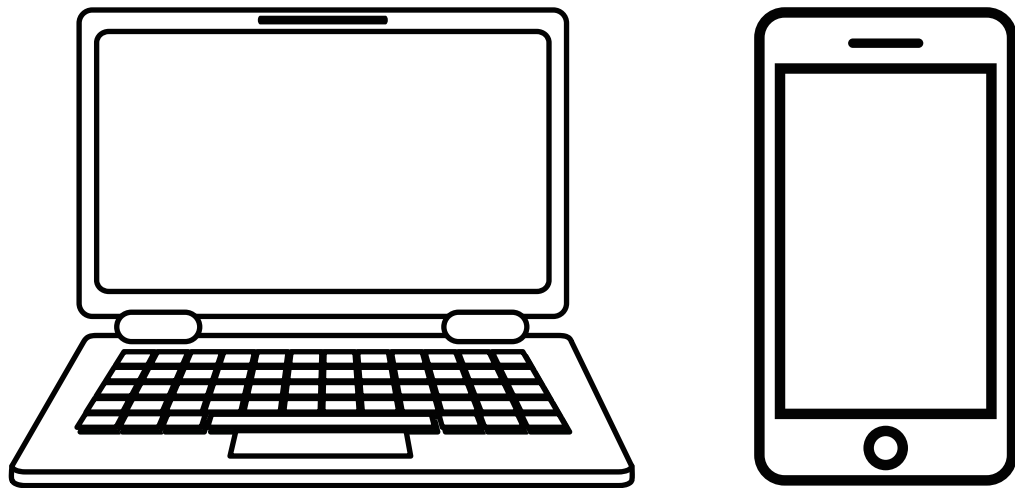

The website can be accessed not only from your computer but also from smartphones and tablets.



Table of Contents

Before You Begin

• Parts of the Speaker	9-19
Light Effect Roller.....	12
Volume Roller.....	12
Bass Boost Button.....	12
Power Button.....	12
Bluetooth Button.....	12
Playback Mode Switch Button.....	13
Ambient Light.....	13
Speaker Strap Ring.....	13
Speaker Handle Slot.....	14
Foldable Touch Screen.....	14
Left/Right Microphone Charging Compartment.....	14
Left/Right Microphone Charging Compartment Indicator Light.....	14
Microphone Sound Effect Switch Button.....	15
Custom Microphone Sound Effect Button.....	16
Music Ducking Button.....	16
Aux Out.....	17
Aux In.....	18

TF Card.....	18
USB.....	18
6.5mm Microphone/Instrument Port.....	18
Microphone/Instrument Switch Button.....	18
Microphone/Instrument Input Gain Knob.....	18
HDMI.....	19
Expansion Port Cover.....	19
Power Charging Port.....	19
Power Charging Port Cover.....	19

• Parts of the Microphones	20-21
Microphone Indicator Light.....	21
Microphone Power Button.....	21
Microphone Volume Control.....	21
Microphone Play/Pause Button.....	21
Microphone Wireless Charging Ring.....	21

• Parts of the Homepage	22-25
Aux Mode.....	23
Bluetooth.....	23
WiFi.....	23
Lighting Mode.....	24

Volume.....	24
Music Effect.....	24
Microphone Effect.....	24
Settings.....	24
Ikarao Service.....	25
Power Icon.....	25
WiFi Icon.....	25
Battery Icon.....	25
Time Icon.....	25

First Steps

Use Carrying Strap.....	27
Using the Speaker Stand.....	28
Speaker Charging.....	29
Microphone Charging.....	30
Power On/Off.....	31

• Basic Settings..... 32-40

About.....	33
Brand Name	
Model Name	
Serial Number	
App Version	
Device Version	
Version Update	

Restore Factory Settings	
Display.....	34
Brightness	
Key Brightness	
Sleep Time	
Sound.....	35
Wireless Mic Volume	
Mic Mode	
WiFi.....	36
WiFi On/Off	
Refresh Available Networks List	
Enter Wi-Fi Password	
Wi-Fi Basic Information	
Storage.....	37
Available Storage	
Storage Control	
USB Drive	
TWS.....	38
TIME.....	39
Automatic Time Update	
24-Hour Format	
Timezone	
Language.....	40

Start to Play

• Local Media Player	42-45
Favorites.....	43
Repeat Mode.....	43
Play from Beginning.....	43
Play/Pause.....	43
Next Track.....	43
Volume.....	43
Playlist.....	43
Add to Queue.....	43
Create Playlist.....	43
Batch Create Playlist.....	44
Page Turning.....	44
Quick Jump to Specified Page.....	44
View Lyrics.....	45
Different Display on External Screen.....	45
Call Up Control Bar.....	45
• Bluetooth Instructions	46-47
Enter Bluetooth Mode.....	46
Connect Bluetooth.....	46
Disconnect Bluetooth.....	47
Display Lyrics in Bluetooth Mode.....	47
View Current Bluetooth Connected Devices.....	47

• Play With Third-Party APP	48
Open Control Bar.....	48
Return to Homepage from Third-Party App.....	48

Troubleshooting

• Network Issues	50-52
What to do if You are Unable to Connect to WiFi?.....	51
What to do if Wi-Fi is Connected but Unable to Access the Internet?.....	51
Why does Wi-Fi Disconnect Automatically?.....	51
Why does Music or Video Playback Stutter?.....	52
• Bluetooth Issues	52-53
Why does the Music Playback Stutter when Using Bluetooth?.....	52
Why can't I Find the Speaker When Pairing via Bluetooth?.....	52
Why does the First Connection to the Speaker's Bluetooth Fail Even Though it is Found?.....	53
Why does Bluetooth Fail to Reconnect?.....	53

• **Microphone Issues**.....54

- Why is there No Sound from My Microphone?..... 54
- Why does the Speaker's Music Volume Automatically Lower When I Sing with the Microphone?..... 54
- Why can't the Microphone Power On?..... 54

• **Local Player Issues**.....55

- Should I Use Music Stored on a TF Card, USB Drive, or External Hard Drive?..... 55
- Why does My Local Player Not Display Lyrics?..... 55

Technical Notes

- Safety Usage**..... 57-58
- Battery and Power**..... 59-60
- Screen Usage**..... 60
- Certifications and Declarations**..... 61-62
- Product Technical Specifications**..... 63-64

Supplied Accessories

The following are included with the speaker:

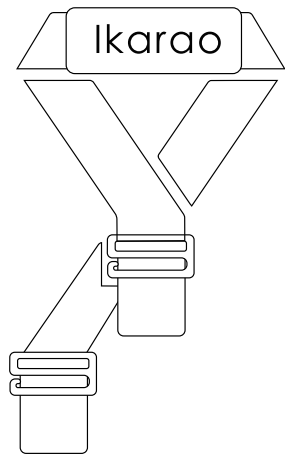

Shoulder Strap

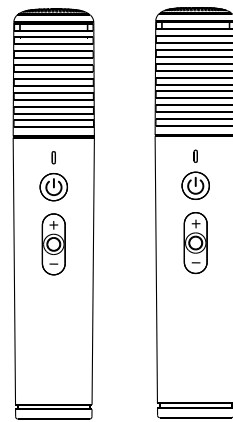

Wireless Microphones * 2

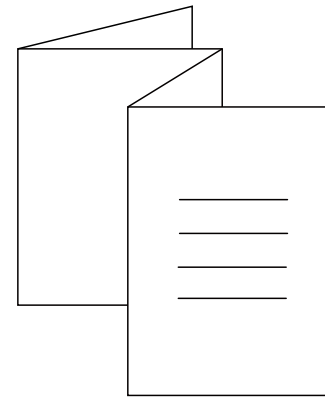

Quick Start Manual

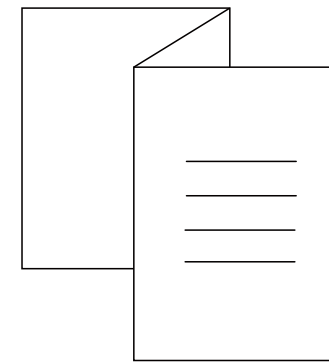

Warranty Card

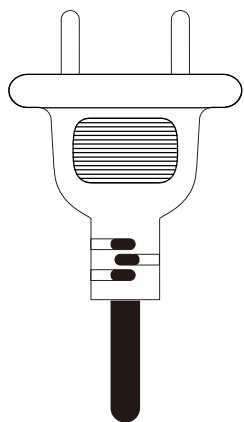

AC Power Cable



01 Before
You Begin

Parts of the Speaker

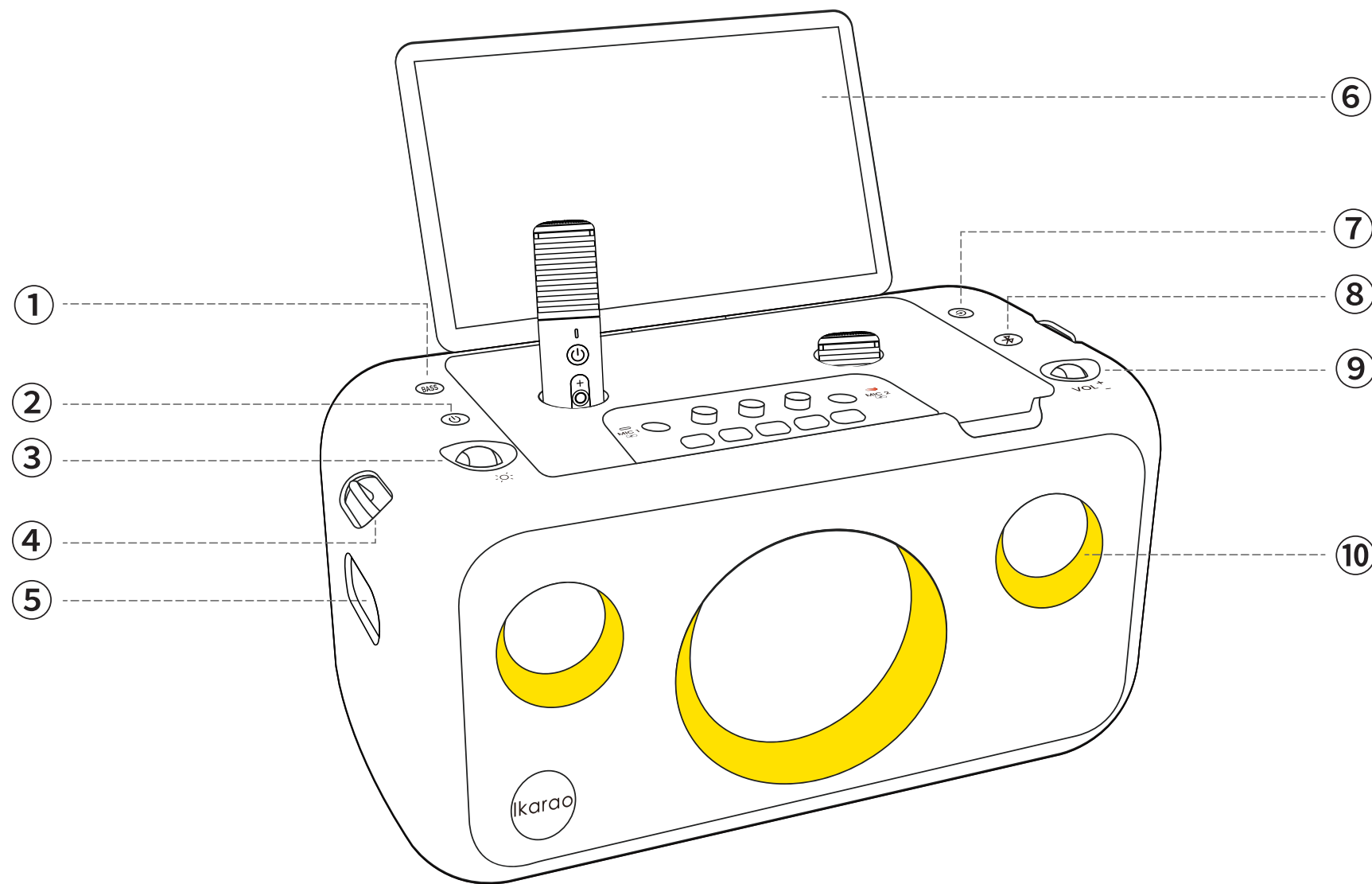

① Bass Boost Button.....	12
② Power Button.....	12
③ Light Effect Roller.....	12
④ Speaker Strap Ring.....	12
⑤ Speaker Handle Slot.....	14
⑥ Foldable Touch Screen.....	14
⑦ Playback Mode Switch Button.....	13
⑧ Bluetooth Button.....	12
⑨ Volume Roller.....	12
⑩ Ambient Light.....	13

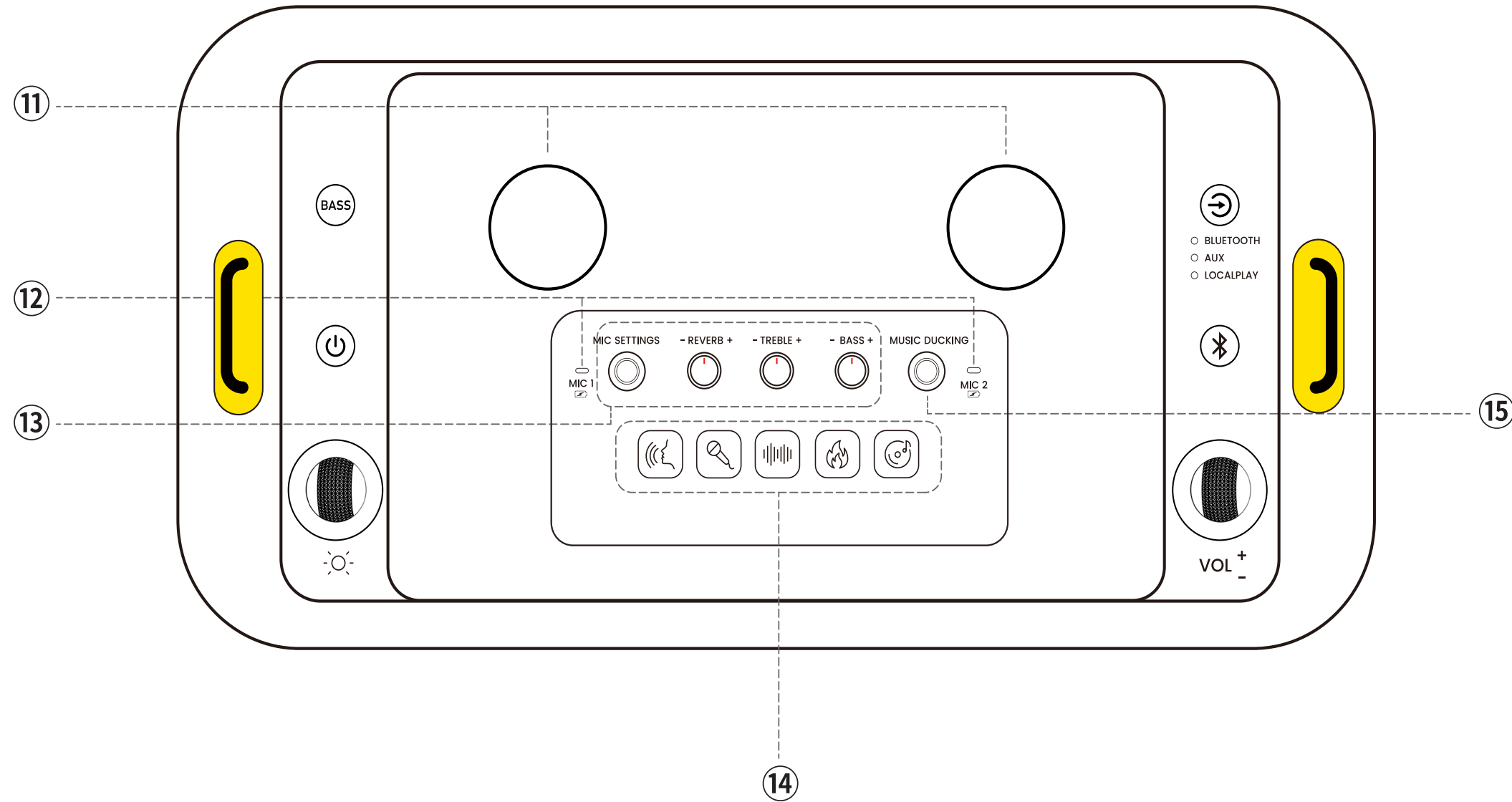

①① Left/Right Microphone Charging Compartment.....	14	①③ Custom Microphone Sound Effect Button.....	16
①② Left/Right Microphone Charging Compartment and Indicator Light.....	14	①④ Microphone Sound Effect Switch Button.....	15
		①⑤ Music Ducking Button.....	16

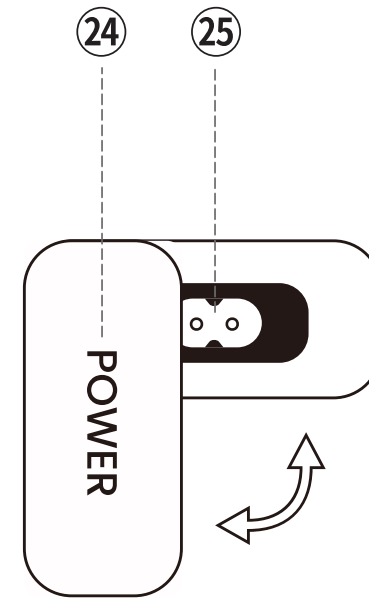
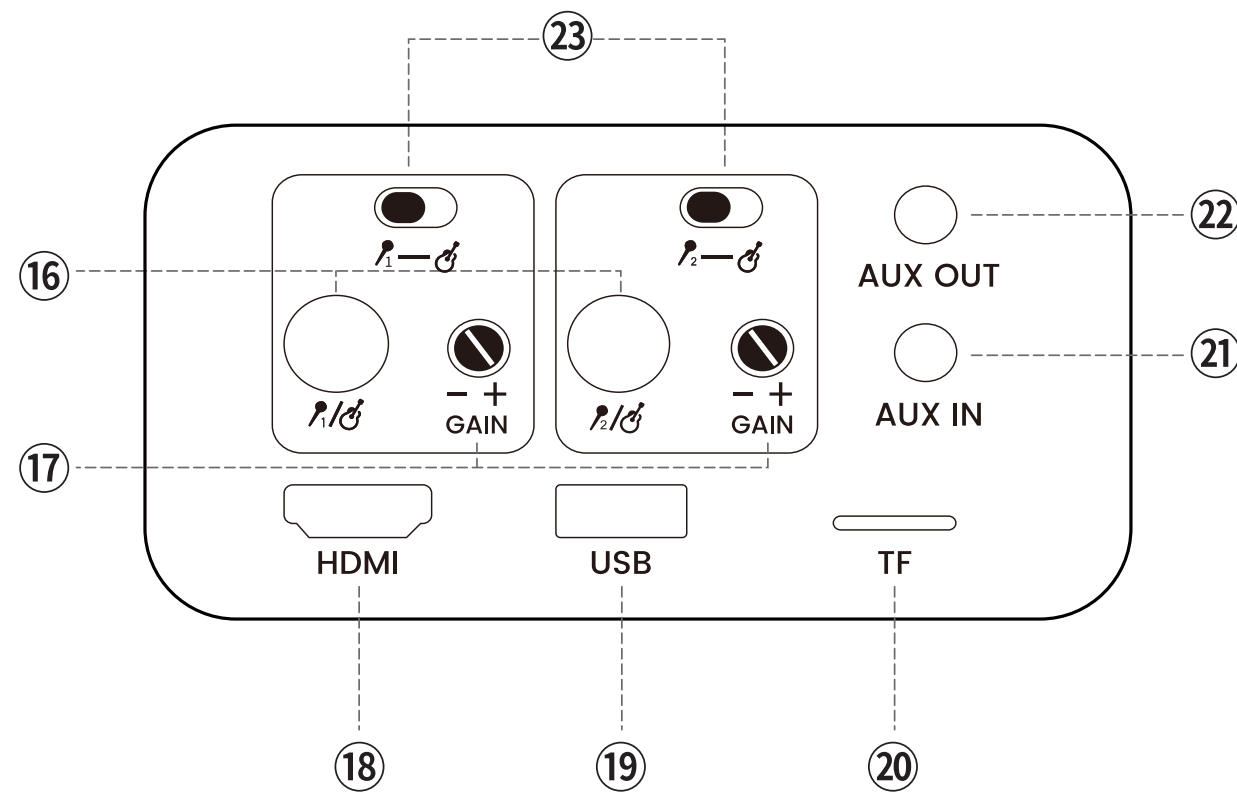

①⑥ 6.5mm Microphone/Instrument Port.....	18
①⑦ Microphone/Instrument Input Gain Knob.....	18
①⑧ HDMI.....	19
①⑨ USB.....	18
②⑦ TF Card.....	18
②① Aux In.....	18

②② Aux Out.....	17
②③ Microphone/Instrument Switch Button.....	18
②④ Power Charging Port Cover.....	19
②⑤ Power Charging Port.....	19
②⑥ Expansion Port Cover.....	19

Light Effect Roller

You can adjust between four lighting effects by toggling the light effect wheel left and right.

(For lighting effects, please refer to  Page 13 - Lighting)

Volume Roller

You can adjust the speaker volume by toggling the left and right volume roller. Microphone volume is controlled separately and not by this volume roller.

(For microphone volume control, please refer to  Page 21 - Microphone Volume Control)

Bass Boost Button

Pressing the Bass Boost button enhances the bass effect.

Power Button

Press and hold the power button to turn the device on or off.

When the device is on, pressing the power button once toggles the screen on/off.

(For shutting down, rebooting, or screen operations via the screen, please refer to  Page 25 - Power Icon)

Bluetooth Button

Single-click the Bluetooth button to enter pairing mode and disconnect from connected Bluetooth devices.

(For playing music via Bluetooth, please refer to  Page 46 - Play With Bluetooth)

Playback Mode Switch

Pressing the play/pause button allows you to switch between three playback sources: LOCAL PLAY - Bluetooth - AUX.

(For playing music via AUX IN, please refer to  Page 18 - Aux In. For playing music via USB, please refer to  Page 18 - USB.)

Lighting

Break X1 features 4 lighting effects. You can also adjust these effects using the light effect roller or the Light option on the screen.

Light	Red, blue, and green gradient from bottom to top, changing color every 3 seconds.
Romantic	Red, blue, and green lights appear simultaneously, flowing slowly.
Dynamic	Single-color lights rotate with the rhythm of the music.
Bright	Red, blue, and green lights open and close with the music rhythm, with the current color fading and changing to the next every 3 seconds.
Close	Turn off lights.
Lights turn yellow when adjusting the volume, changing with the volume level.	

Speaker Strap Ring

Used to secure the included shoulder strap.

(For instructions on attaching the shoulder strap, please refer to  Page 27 - Installing the Shoulder Strap.)

Speaker Handle Slot

Used for lifting and carrying the speaker with both hands.
(NOTE: For your safety and product integrity , avoid carrying the speaker with one hand.)

Foldable Touch Screen

Supports a 120° fold, multi-point hover, and 180° rotation touch screen.

Left/Right Microphone Charging Compartment

Stores and charges the microphones.





Left/Right Microphone Charging Compartment Indicator Light

Indicates the charging status of the microphone. A red light means the microphone is currently charging; when the red light is off, the microphone is not charging.

(For details, see  Page 30 - Microphone Charging.)

Microphone Sound Effect Switch Button

Press to switch microphone sound effects.

Icon	Microphone sound effects	Described
	Original Mode	Original sound without any effects.
	Karaoke Mode	Increased delay and mid-frequency boost for a magnetic vocal tone, simulating the 90s Karaoke era.
	Super Reverb Mode	High reverb for a spacious sound, ideal for ethereal songs.
	Popular Mode	Balanced reverb and clear EQ for most pop music.
	Profession Mode	Minimal effects for skilled singers to achieve a performance-level sound.
* On screen only	Cartoon Mode	Playful and cute tone, like a cartoon fairy.
	Monster Mode	Deep and frightening tone, like a movie monster.

Custom Microphone Sound Effect Button

- REVERB +

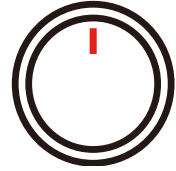

- TREBLE +

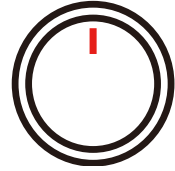

- BASS +

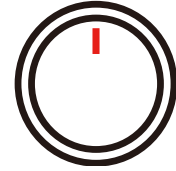

Single-click MIC SETTING to activate the custom microphone effect. Adjust the microphone's Reverb, Treble, and Bass effects by rotating the respective knobs.

Music Ducking Button

MUSIC DUCKING

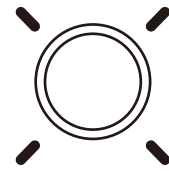
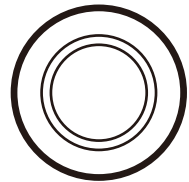

*ON

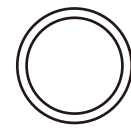

*OFF

Single-click Music Ducking to activate the mode where the speaker volume lowers when vocals are detected, giving priority to speech. This is useful for making announcements at parties or events without stopping the music.

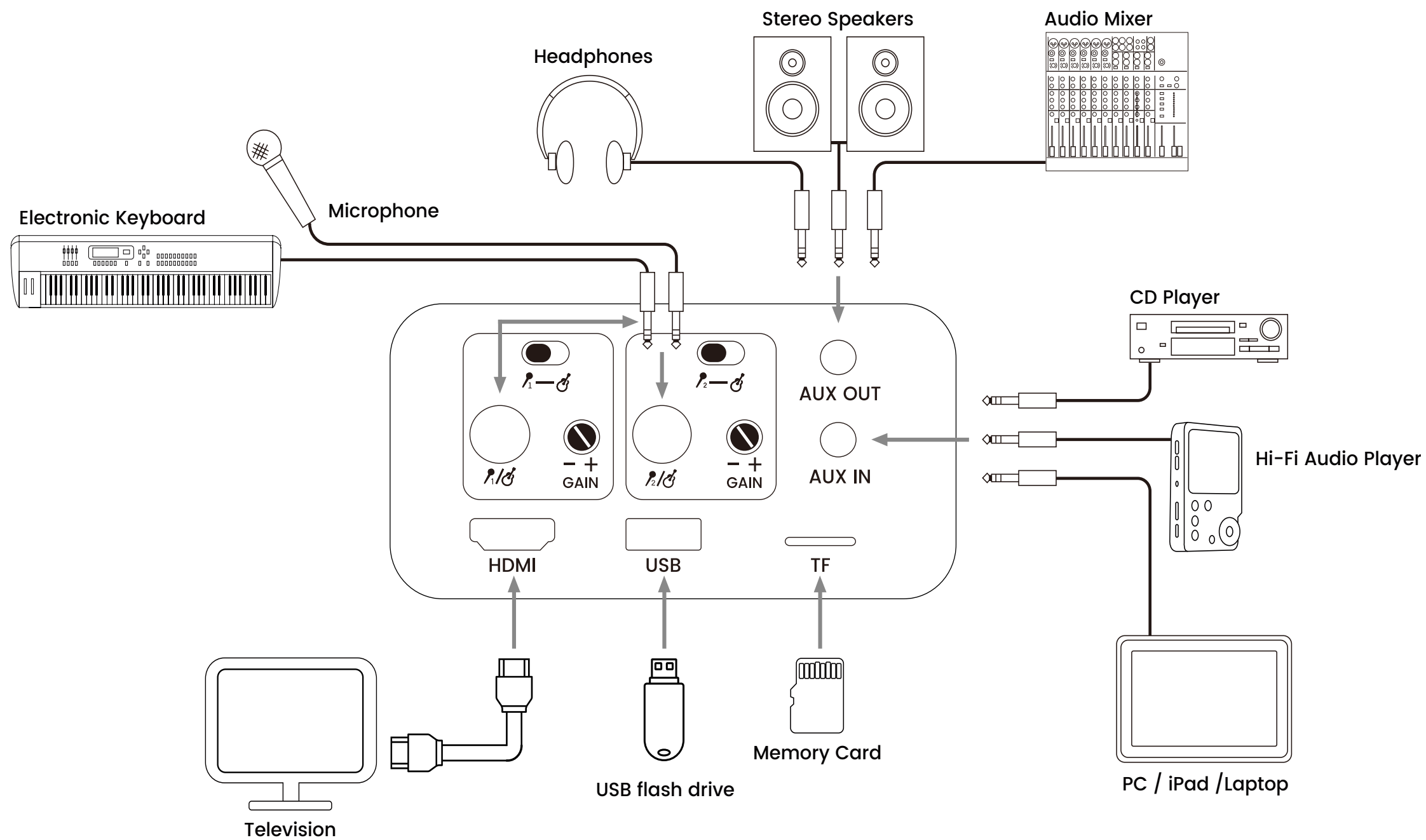

Aux Out

Outputs all sounds, including from the speaker and microphone, via a 3.5mm audio cable. The speaker will be silent during this time. Use Aux Out to connect the Ikarao speaker to a higher-power sound system or for headphone monitoring.

Aux In

Allows external devices such as PCs, laptops, iPods, CD players, and digital audio players to be used as the Ikarao Speaker's audio source via a 3.5mm audio cable. When a device is detected in the Aux In port, the playback mode automatically switches to LOCAL PLAY.

TF Card

Use a TF card as external storage for the Ikarao Speaker.

USB

Supports external storage using USB drives or external hard drives, and provides 5V, 1A power supply.

Supported Storage Formats	EXFAT/FAT32/NTFS/EXT4
Maximum Supported Memory	TF Card: 256GB USB: 1TB
Supported Media Codec Formats	AAC/AC3/APE/FLAC/M4A/MP2/MP3/WMA/OGG/3G2/3GP/AVI/FLV/MKV/MOV/MP4/MPG/VOB/WMV

6.5mm Microphone/Instrument

Supports connecting wired microphones or instruments like guitars and electric pianos via a 6.5mm audio cable.

Microphone/Instrument Switch Button

Toggle left or right to select the input device type.

Microphone/Instrument Input Gain Knob

Use the knob for precise adjustment of input gain.

HDMI Port

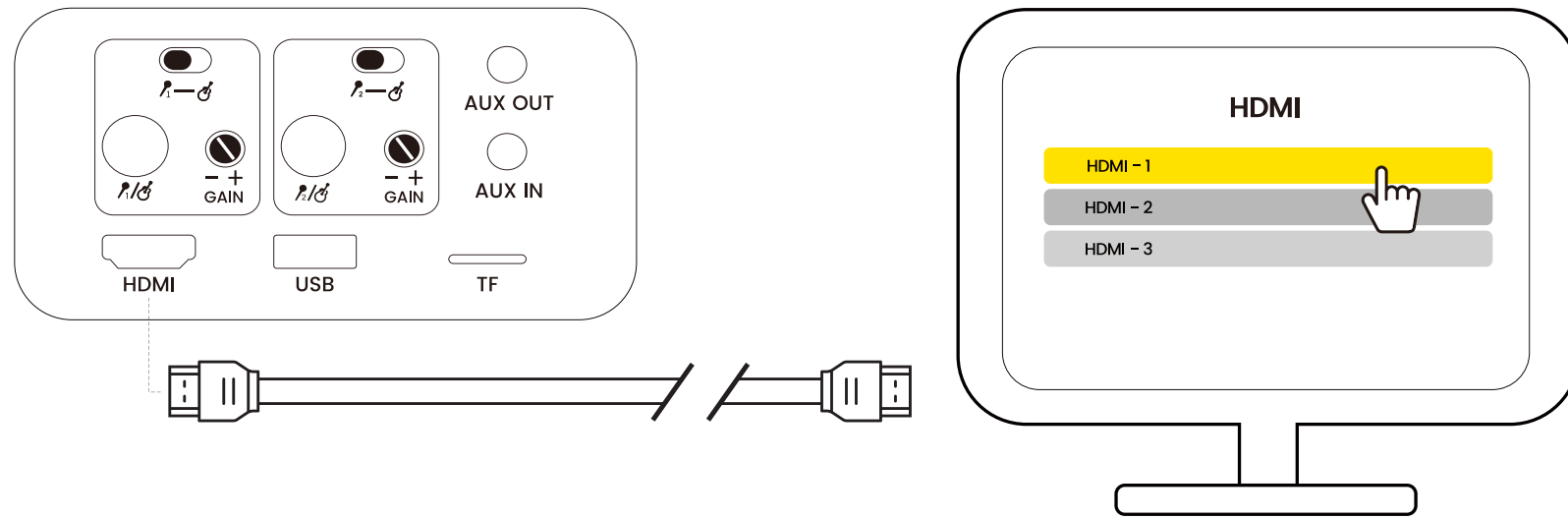

Use HDMI cable to connect to monitors, TVs, or projectors, supporting up to 1080P resolution. Compatible with HDMI protocols HDMI 1.4 and HDMI 2.0.

Expansion Port Cover

Protects the expansion ports and features product labeling stickers.

NOTE: Do not remove the product label sticker, which contains important information including serial number and FCC ID.

Power Charging Port

AC power port for charging.

Power Charging Port Cover

Protects the power charging port effectively.

Parts of the Microphones

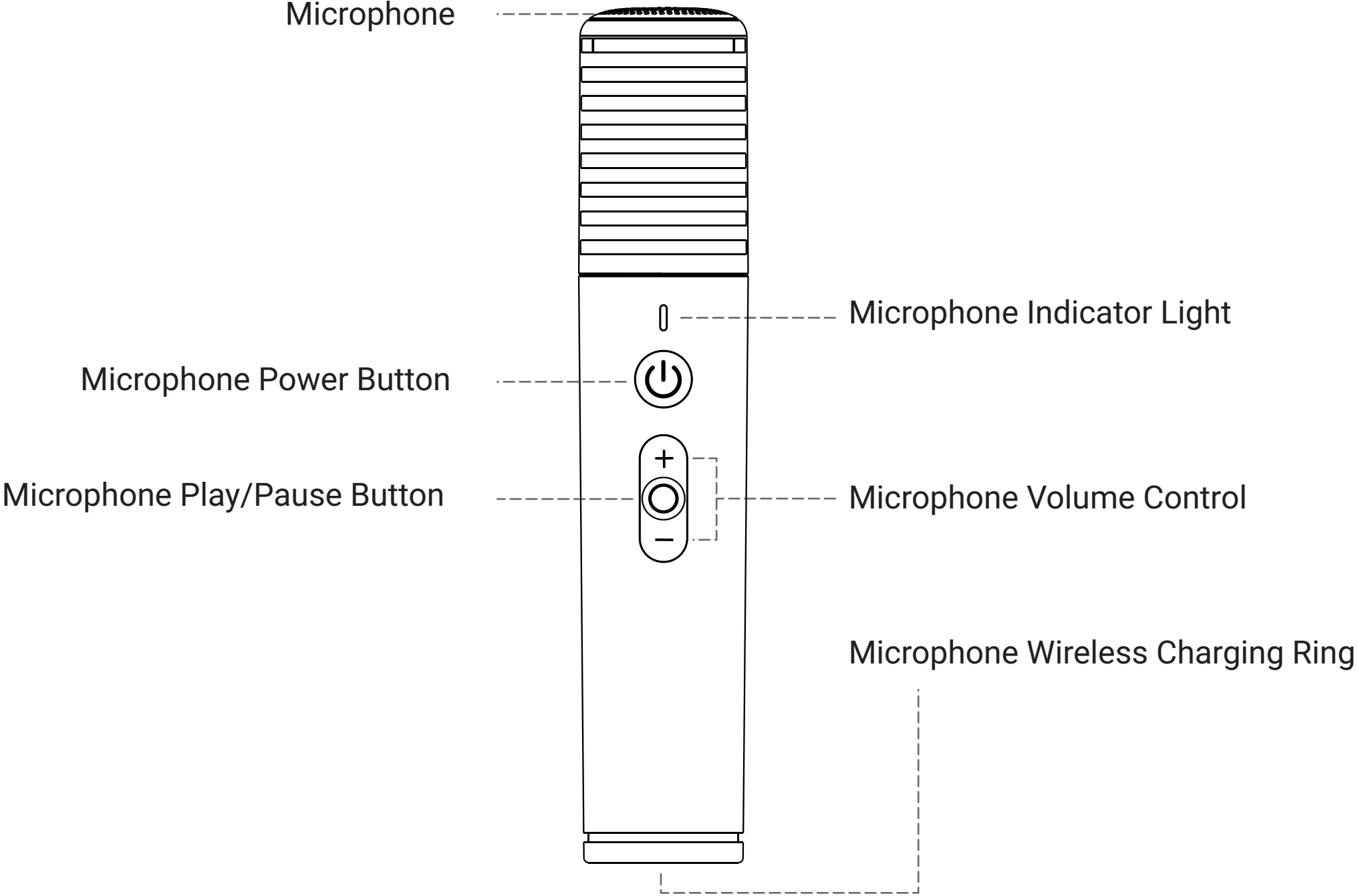

Microphone

Dynamic microphone for picking up sound signals.

Microphone Indicator Light

Displays various microphone statuses.

Microphone Power Button

Press and hold for 2 seconds to power on/off;
Double-press to quickly switch sound effects.

Microphone Volume Control

Adjust the microphone volume.

Microphone Play/Pause Button

Press once to play/pause audio and video (Bluetooth and Local Media Player).
Long press to skip to the next song.

Microphone Wireless Charging Ring

For wireless charging of the microphone.
NOTE: Avoid spilling liquids on the wireless charging ring.

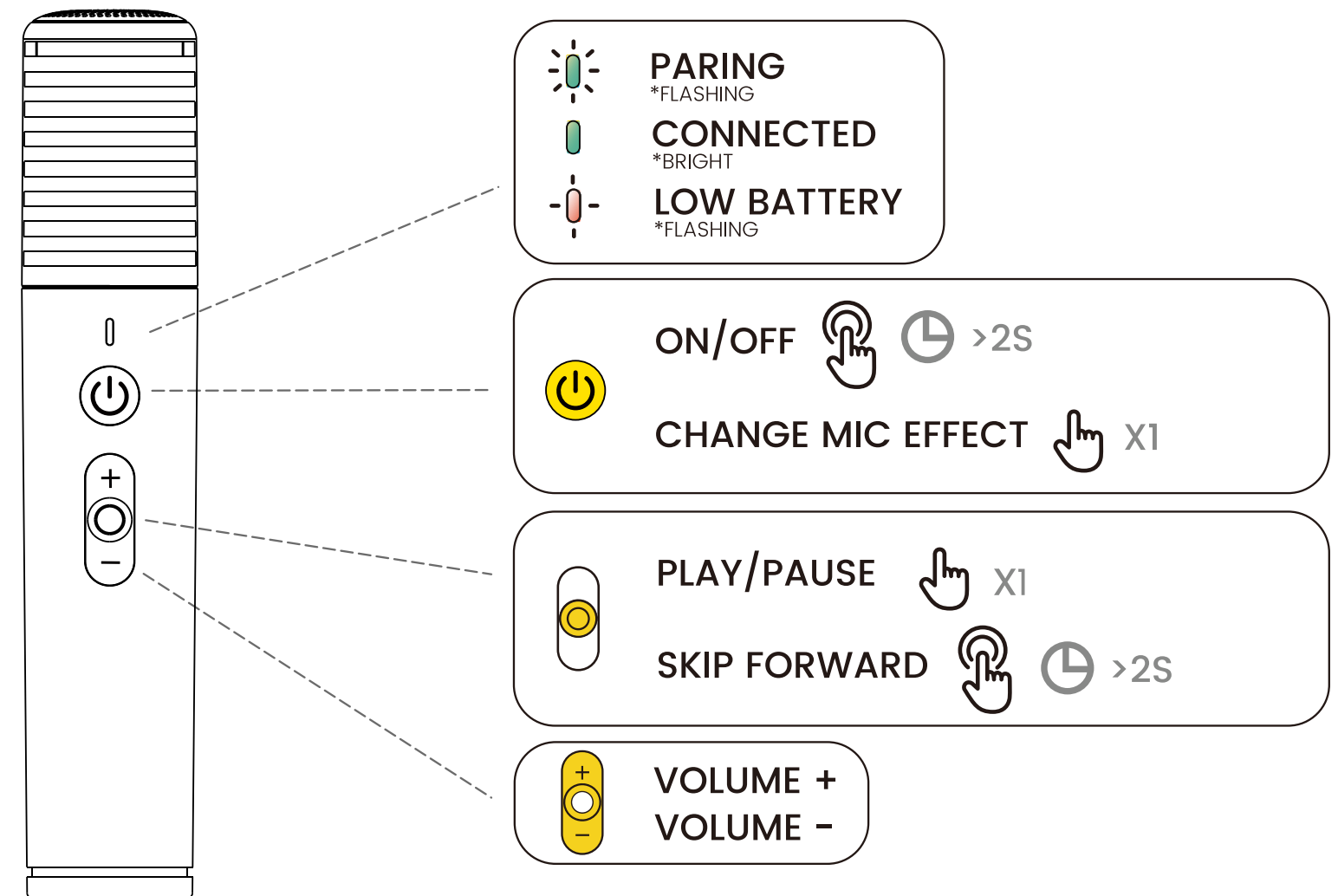

Parts of the Homepage

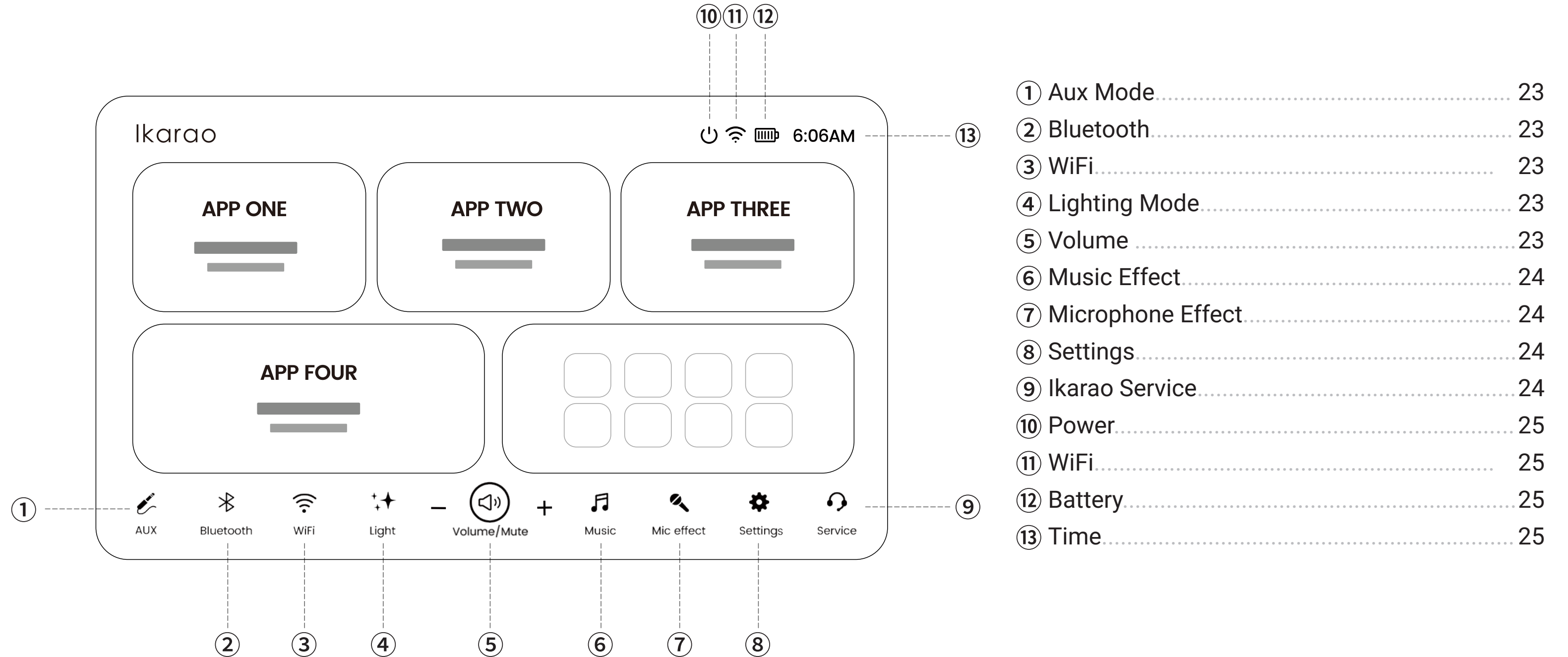

① Aux Mode.....	23
② Bluetooth.....	23
③ WiFi.....	23
④ Lighting Mode.....	23
⑤ Volume	23
⑥ Music Effect.....	24
⑦ Microphone Effect.....	24
⑧ Settings.....	24
⑨ Ikarao Service.....	24
⑩ Power.....	25
⑪ WiFi.....	25
⑫ Battery.....	25
⑬ Time.....	25

Aux Mode

Click to enter Aux Mode. You can also access it via the Playback Mode button. Connecting a device to Aux In will automatically switch to the Aux Mode page.

Bluetooth

Click to enter Bluetooth Mode. You can also access it via the Playback Mode button.

WiFi

Click to enter WiFi settings. You can also access it through the Settings menu.

Light

Click Light to enter light adjustment.

(For light instructions, see  Page 13 - Lighting)

Volume

Use the +/- buttons to adjust the speaker volume. Tap the center button to mute. You can also adjust the volume with the volume wheel.

(For volume roller adjustments, see  Page 12 - Volume Roller)

Music Mode

Click to enter Music Mode to control the speaker's sound effects.

Sound Effect Mode	Description.
HiFi	Restores the purity of sound, focusing on original details and dynamics.
Light	Enhances midrange clarity, suitable for vocal-centric music.
Outdoor	Emphasizes bass and treble, effectively increasing loudness for outdoor use.
Bass	Boosts low frequencies to energize music, ideal for rhythmic tracks.

Microphone Effect

Click to enter microphone sound effect adjustment.

Setting

Click to enter settings.

(For detailed settings, refer to  Page 32-40 - Settings.)

Ikarao Service

Ikarao after-sales service page. You can scan the QR code or fill out a form to get technical support.

Power Icon

Click the Power icon on the screen to shut down, restart, or turn off the screen.

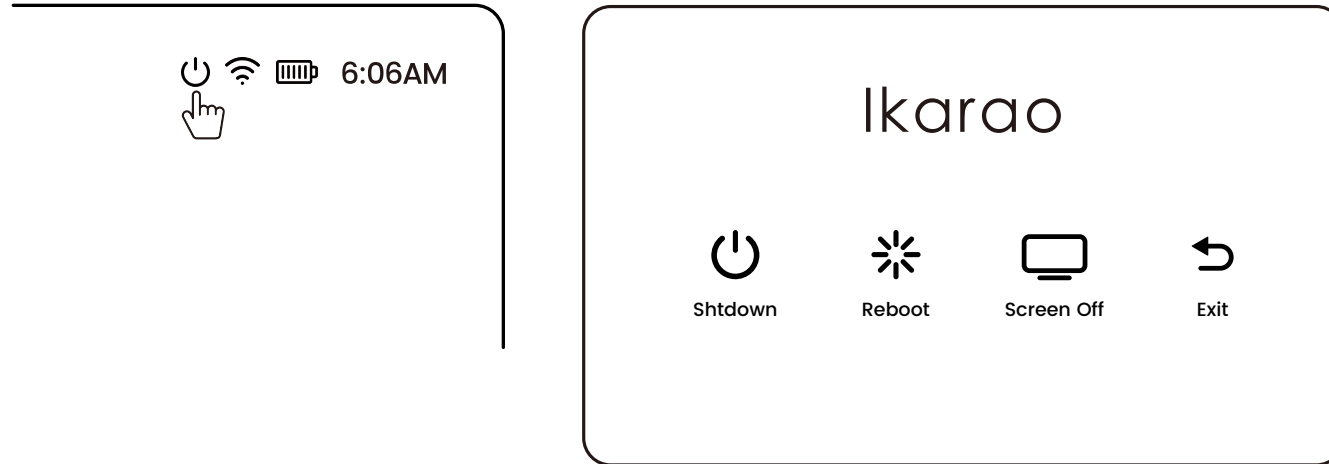

WiFi Icon

Indicates Wi-Fi is connected.

Battery Icon

Indicates battery status.

Time Icon

Displays the time. For first-time use, the time is automatically set when connected to the internet; otherwise, configure the time manually.

(For manual time configuration, refer to  Page 39 - Time)



02

**First
Steps**

Use Carrying Strap

1 Take out Carrying Strap

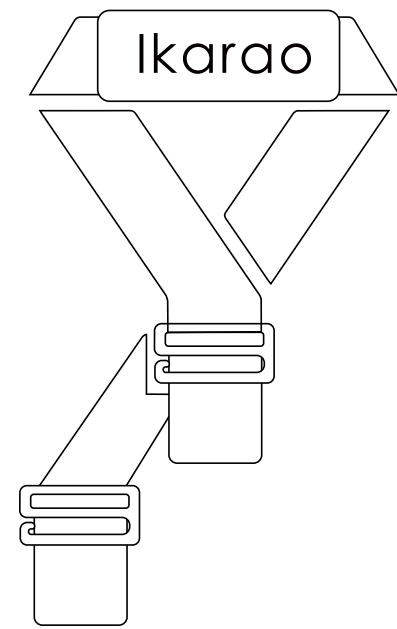

Carrying Strap

2 Buckle up Carrying Strap

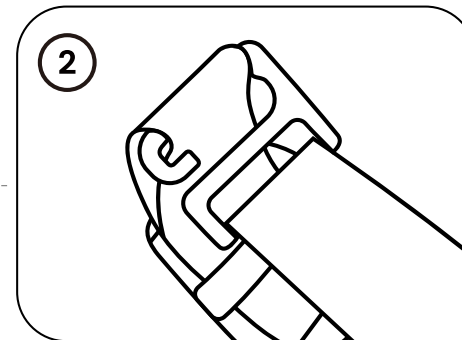
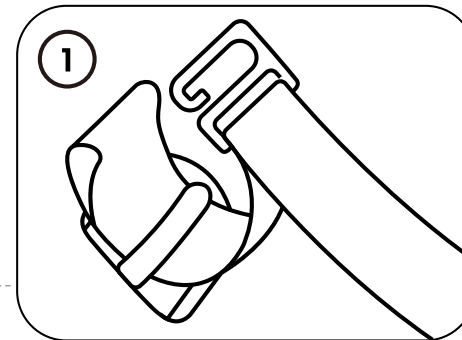
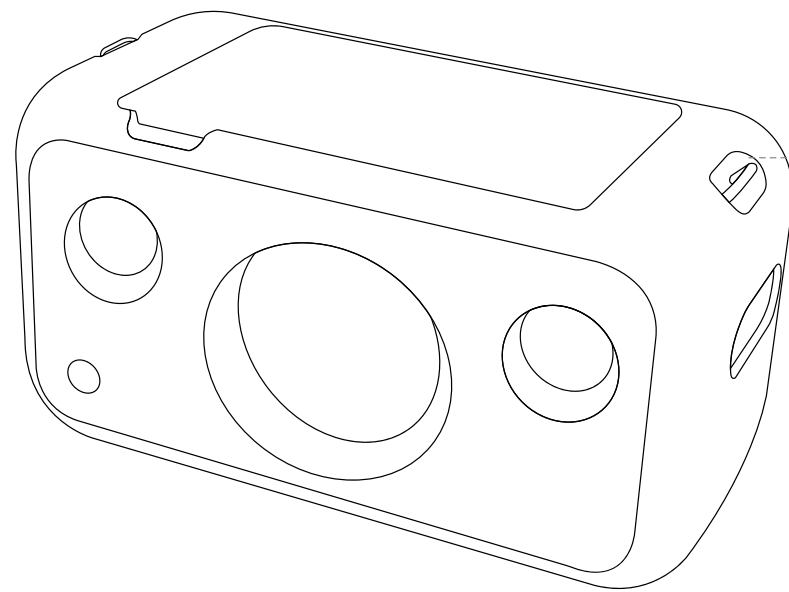

NOTE: Please fasten the strap to ensure your speaker can be carried safely.

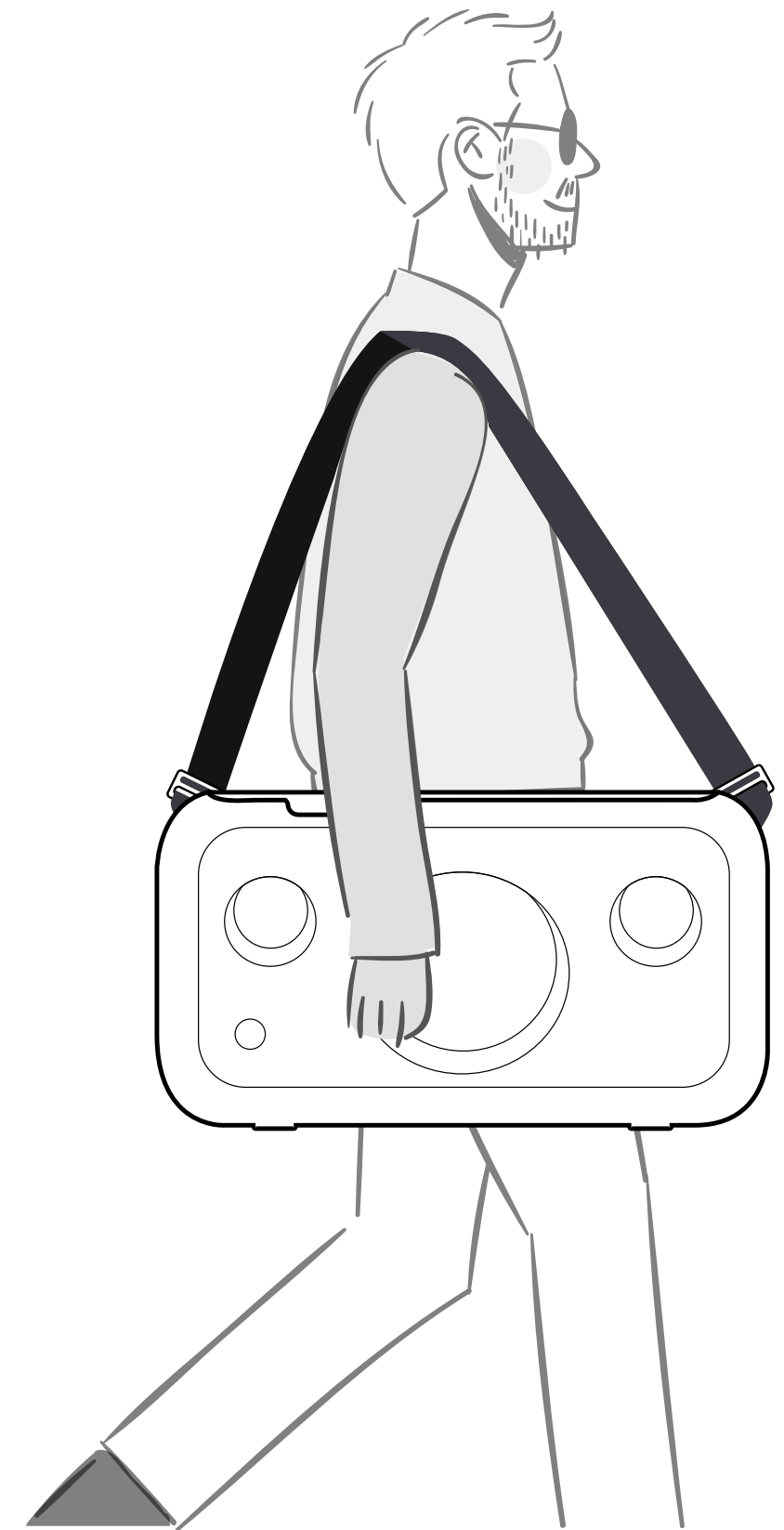

Using the Speaker Stand

- 1 Extend the speaker stand and find the 35mm mount hole on the bottom of the Break X1

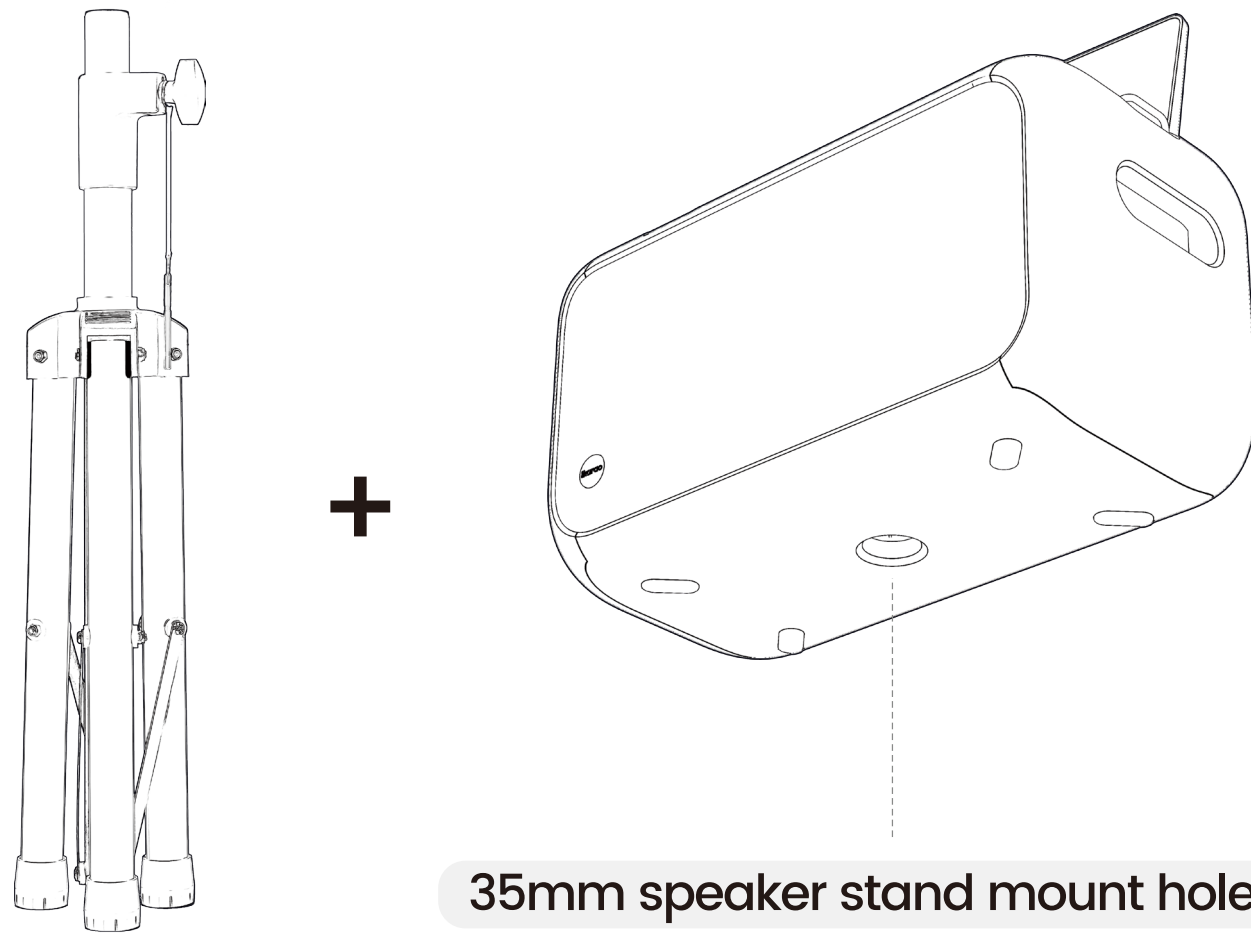

35mm speaker stand mount hole.

NOTE: The Speaker Tripod Stand requires a separate purchase.

- 2 Place the speaker securely on the stand. For safety, it is recommended to have two people.

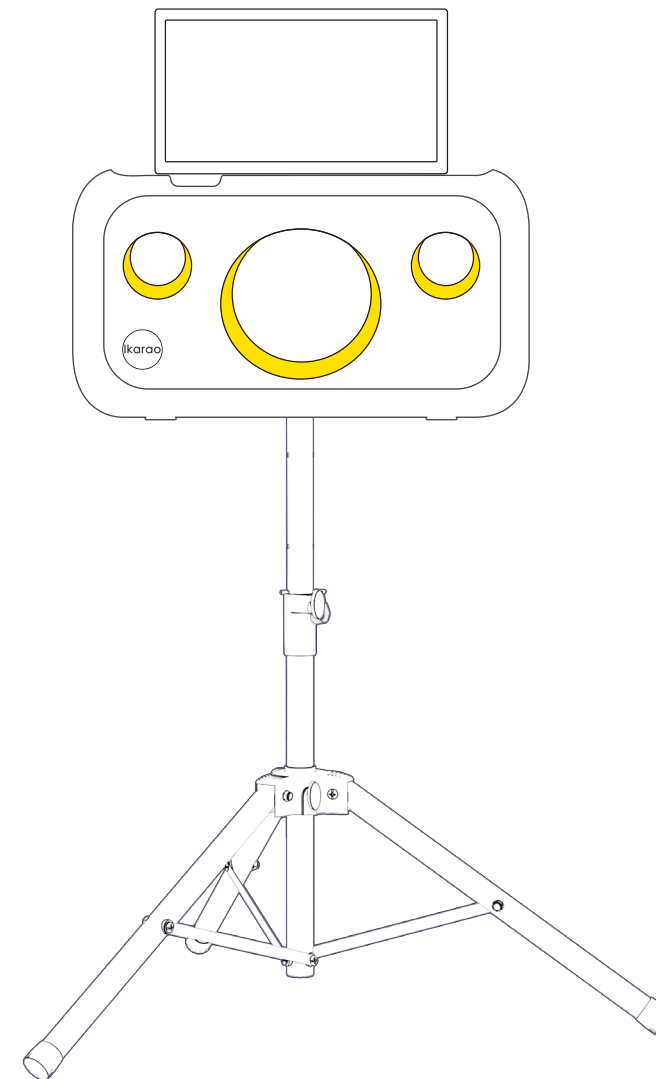

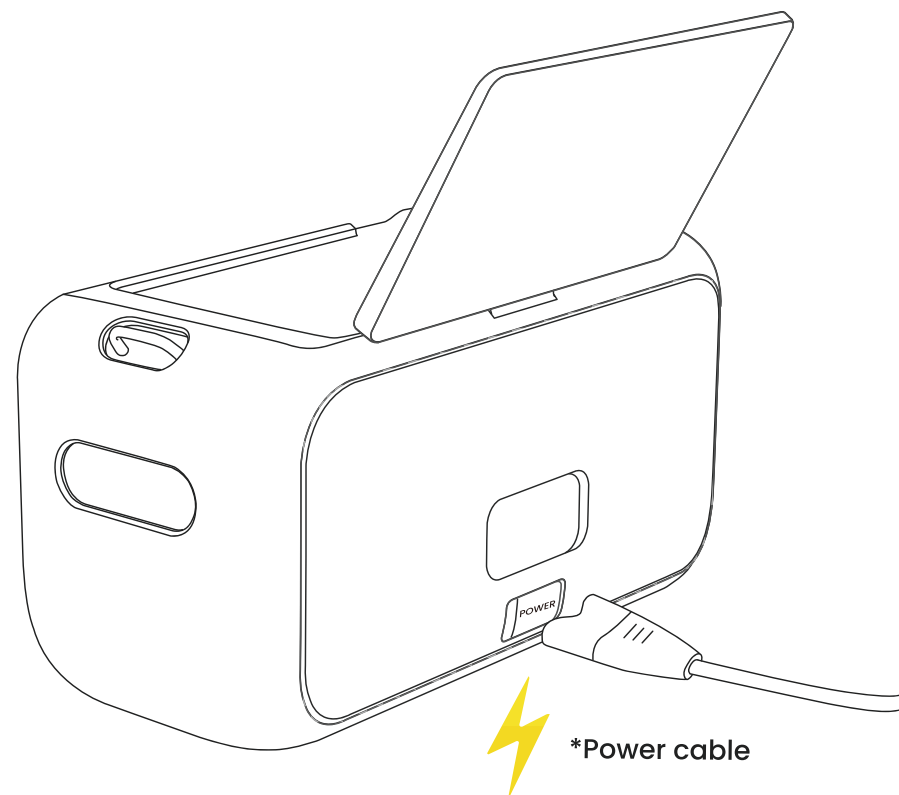

Speaker Charging

1 Charging with the included power cable.



NOTE: The included power cable supports 100V-240V.

2

-  **LOW BATTERY**
*SLOW FLASHING
-  **CHARGING**
*BREATHING
-  **FULLY CHARGED**
*OFF

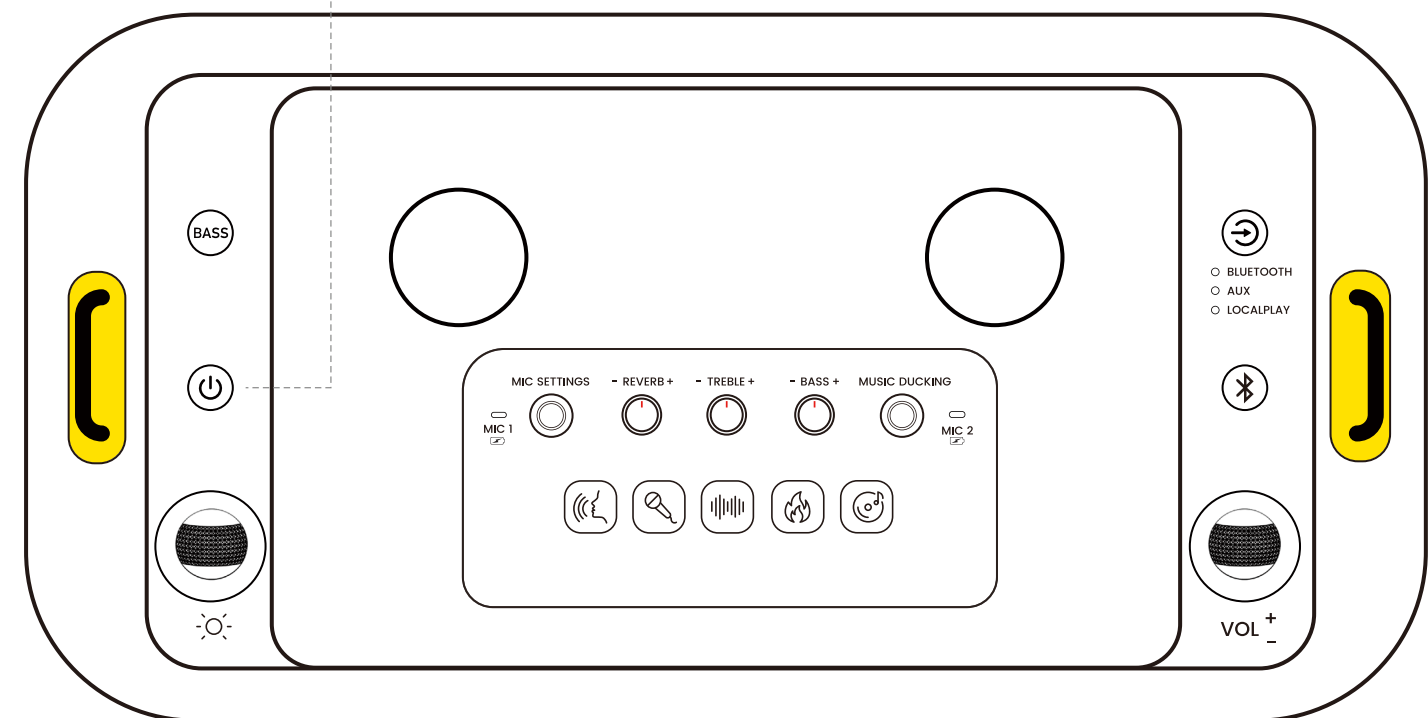

Microphone Charging

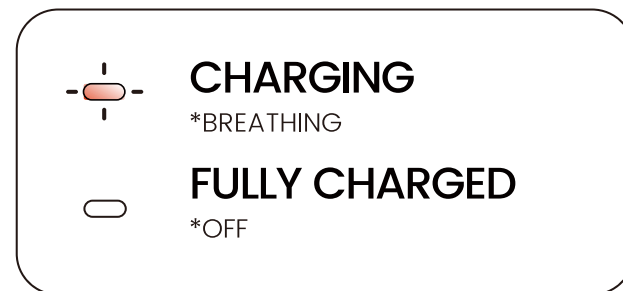

Tap the microphone into the storage to begin charging.

NOTE: Microphone has a 30-hour usage duration

with a 5-hour full charge time.

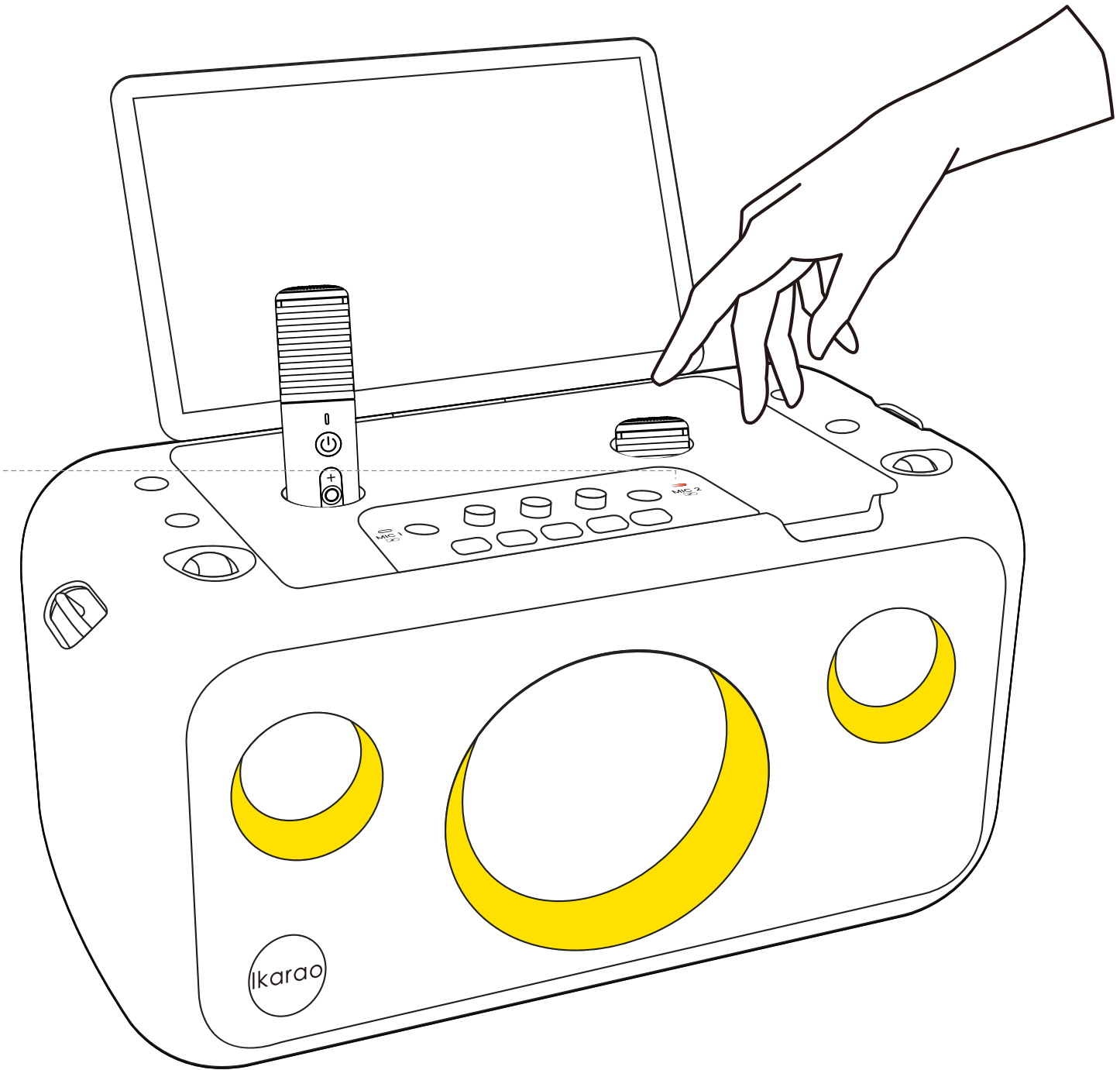

Power On/Off

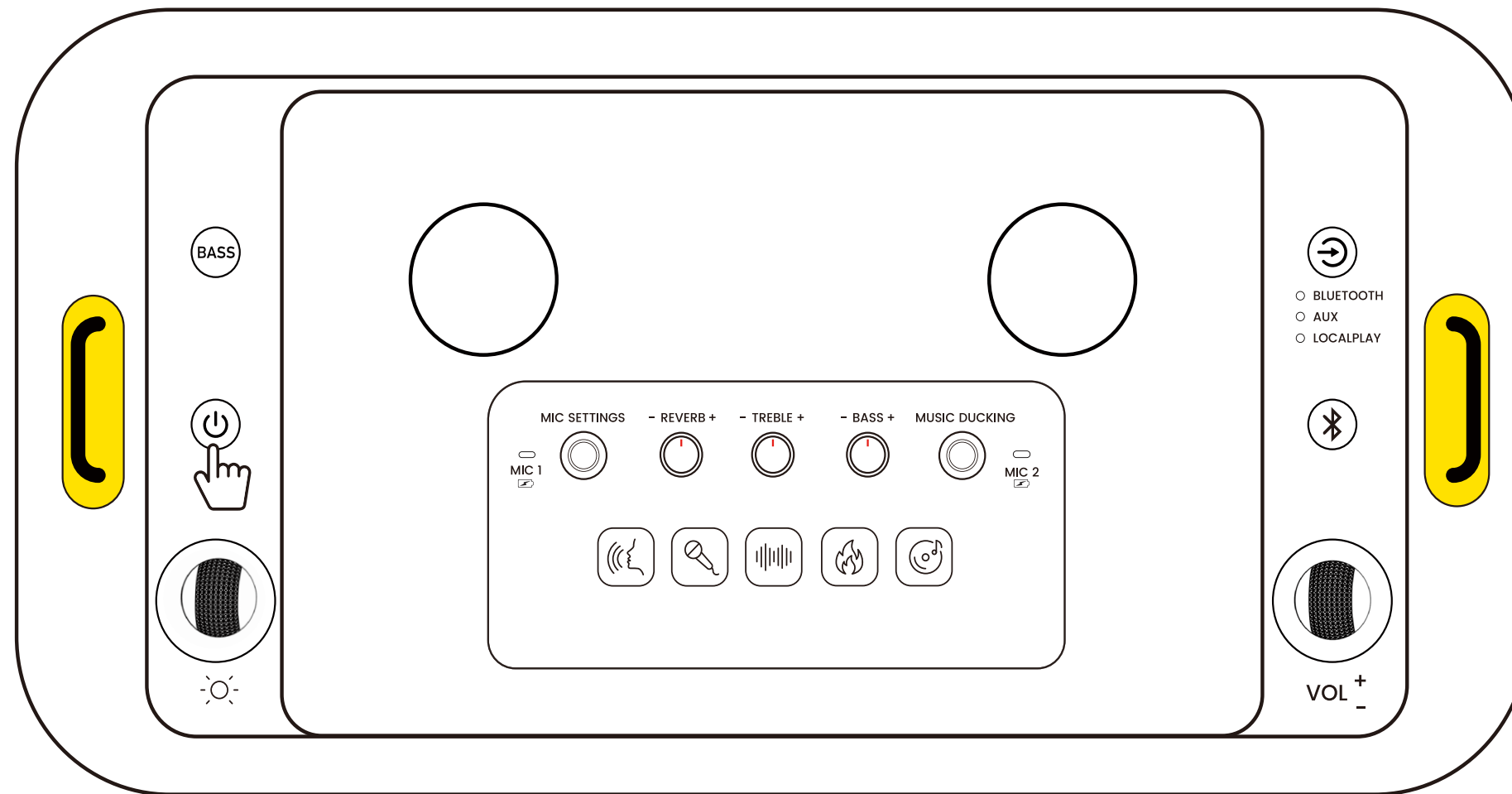

Press and hold the power button for 3 seconds to turn the device on or off.
When the device is on, single-click the power button to turn the screen off or on.

Basic Settings

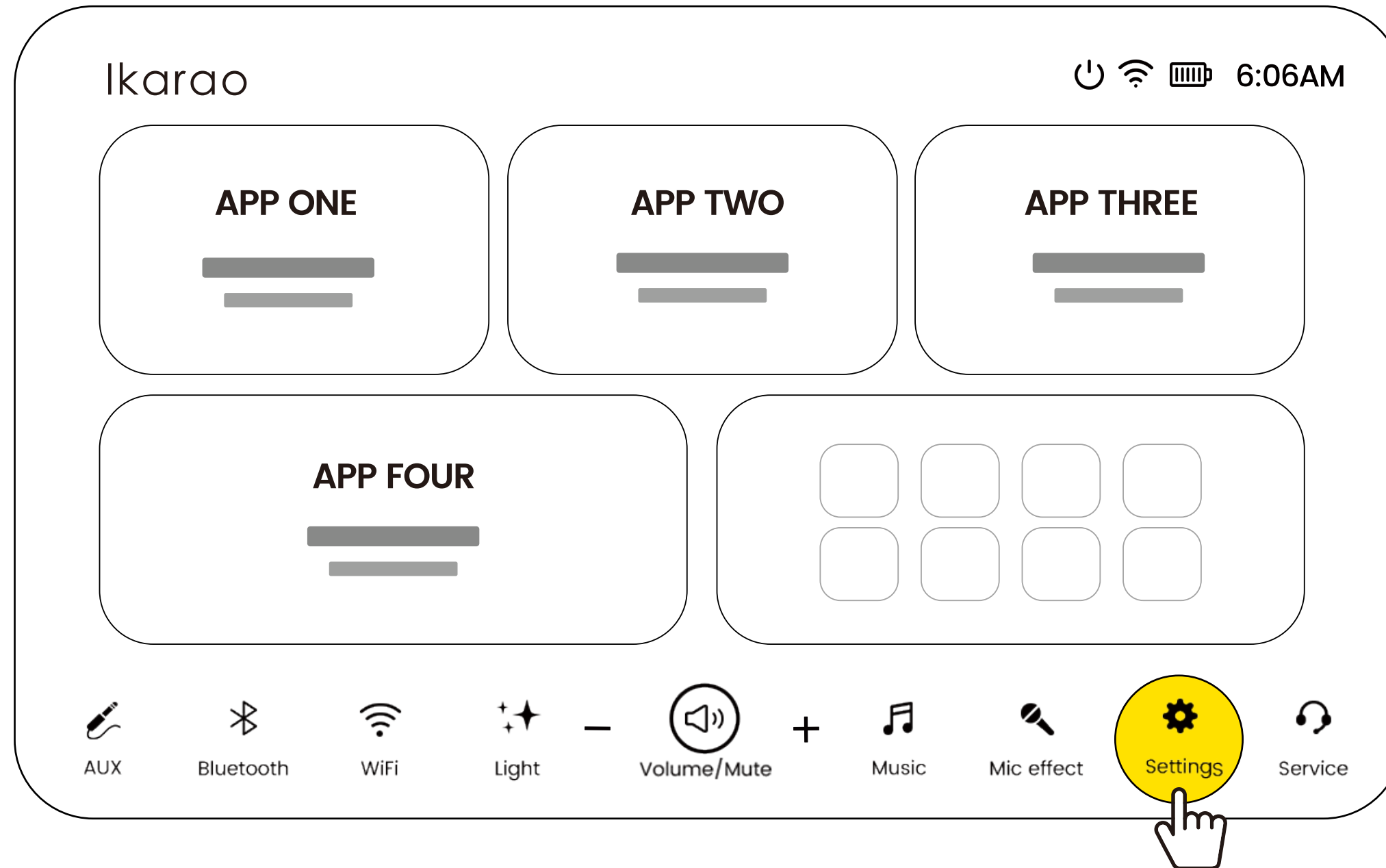

About

Brand Name

Displays the product name - Ikarao

Model Name

Displays the model of the device

Serial Number

The unique identifier for Ikarao products

App Version

The current system version

Device Version

The current device version

Version Update

Click "Detect New Version" to update the version. To ensure a successful upgrade, please connect to a power source or ensure the battery is above 50% before upgrading.

Restore Factory Settings

Click "Restore Factory Settings" to revert to factory settings.

Please Note:

1. This action will erase all user data.
2. After restoring factory settings, the speaker will automatically restart. The restart process takes about 2-3 minutes. Please keep the speaker connected to a power source, do not perform any operations, and wait patiently for the speaker to complete the startup process.

Display

Brightness

Drag the slider left or right to adjust the screen brightness.



Key Brightness

Drag the slider left or right to adjust the backlight brightness of the keys.



Sleep Time

Select the number of minutes of inactivity after which the device will automatically shut down.

Sound

Tone Volume

To control the volume of the prompt tone

Wireless Mic Volume

Indicates the connection status and volume of the wireless microphone



Mic Mode

Microphone mode switch

WiFi

WiFi Switch

Click the button to turn the WiFi on or off.

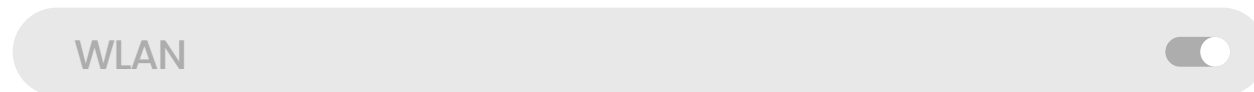

Refresh

If your WiFi name is not found, click Refresh to update the available network list.

Available Network



Enter Wi-Fi Password

1. Wi-Fi Password Display, Displays the entered Wi-Fi password.
2. Connects to the selected Wi-Fi network.



Wi-Fi Basic Information

Displays basic information about the current Wi-Fi connection.



1. Connection Speed
Shows the maximum bandwidth of the connected Wi-Fi.
2. Signal Frequency
Indicates the frequency band of the current Wi-Fi.
3. Security
Indicates the encryption protocol of the current Wi-Fi.
4. IP Address
Displays the IP address of the current Wi-Fi.

Storage

Storage

Displays the current used storage and total storage.

Storage Control

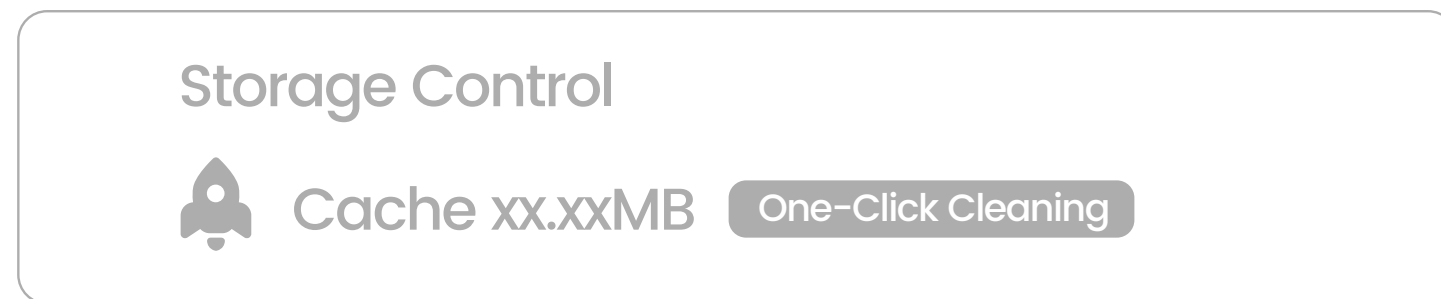

Cleanup Acceleration

Cache **MB indicates the storage space occupied by the current cache.
One-Click Cleaning clears the cache with one click.

USB Drive

If you insert an external storage device, the used capacity/available capacity of the external storage device will be displayed here.

TWS

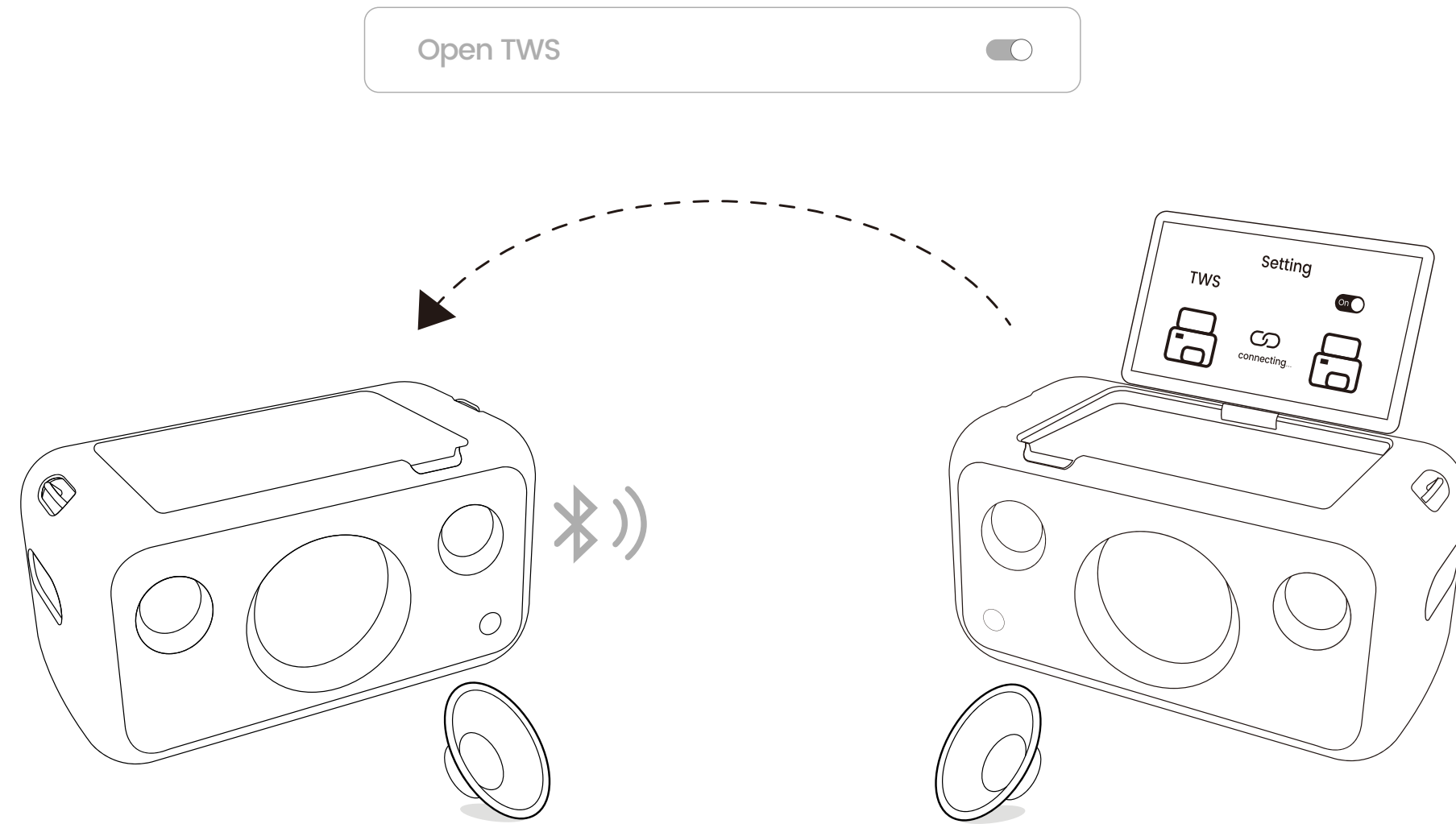

You can wirelessly connect two Break X1 speakers or pair a Break X1 with a Break X1 for stereo sound.

1. Activate TWS on the main speaker by tapping the TWS symbol in Settings, then select Open TWS.
2. Turn on the TWS switch on the second speaker.
3. Wait for the connection. Once connected, play audio from the main speaker. Do not exit the TWS page on the second speaker.

NOTE: With TWS enabled, music plays from both speakers for true stereo sound. However, the microphone sound can only come from the connected speaker due to Bluetooth protocol limitations.

Time

Automatic Time Update

Automatically updates the current time.

24-Hour Format

Enables 24-hour time format.

Timezone

Select your region and timezone.

Time

If Automatic Time Update is off, you can manually set the time.

Date

If Automatic Date Update is off, you can manually set the date.

Language

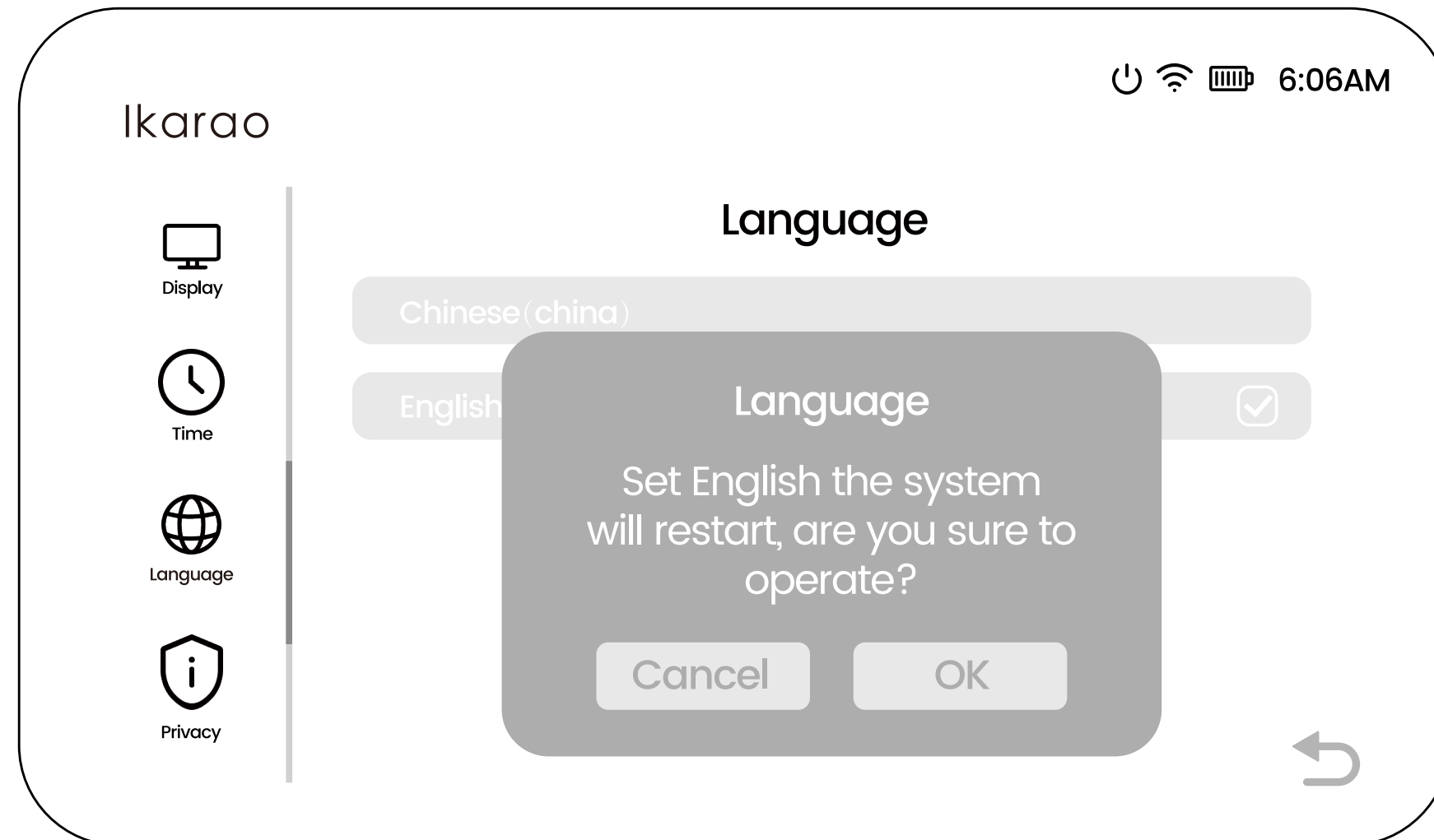

Select System Language

When switching languages, the Break X1 will restart.

Please do not perform any other operations on the speaker during the restart.



03

**Start
to Use**

Local Media Player

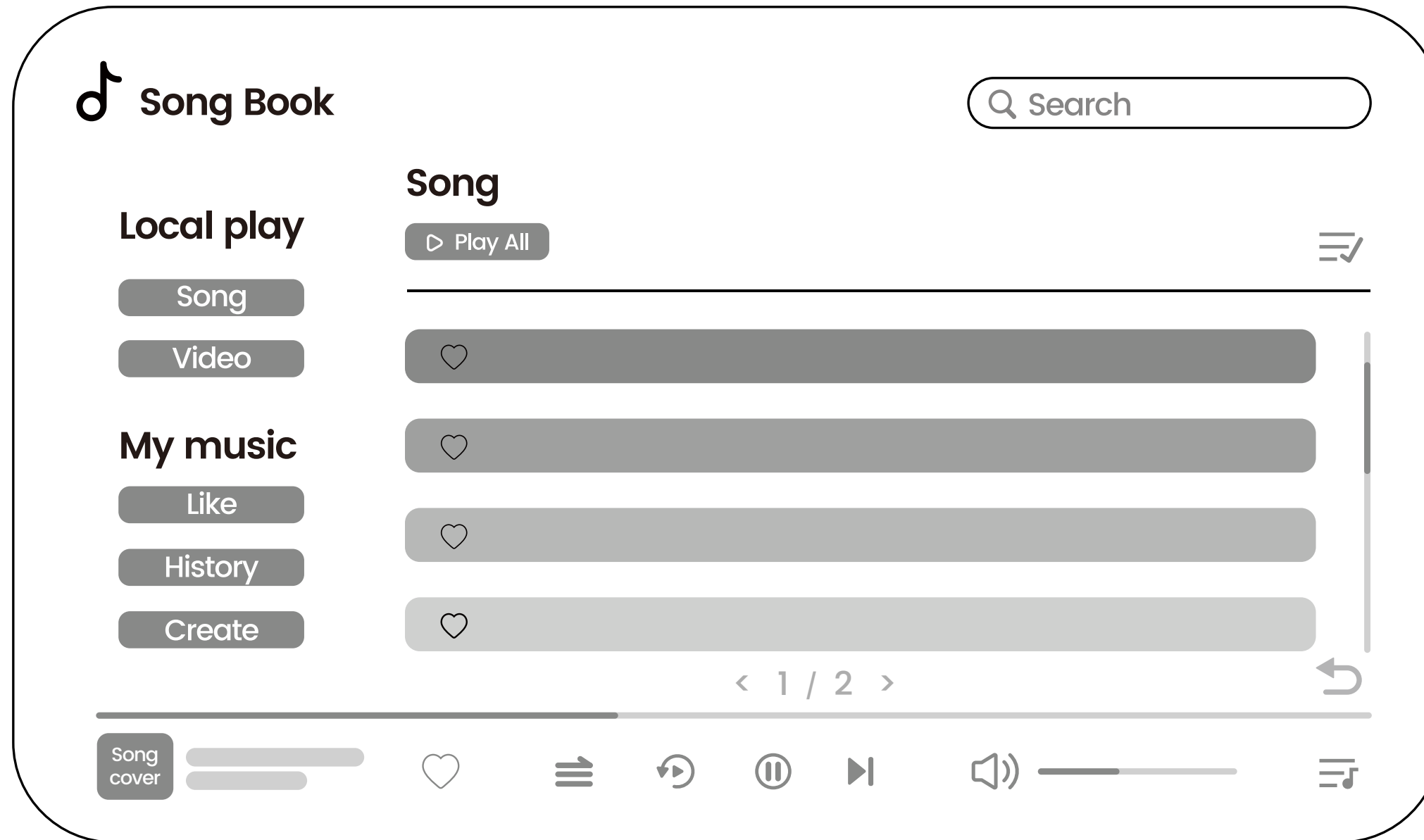

Favorites

Click the heart icon to add music to your favorites.
View favorites in the Like section.

Repeat Mode

Single repeat - Shuffle - Sequence play

Play From Beginning

Click to play from the start.

Play/Pause

Click to play or pause.

Next Track

Click to skip to the next song.

Volume

Drag to adjust the volume.

Playlist

Displays the current Playlist.

Add to Queue

Click the plus icon to add songs to the Playlist.

Create Playlist

Click Create on the Add to Queue page or in My Music to create a Playlist.

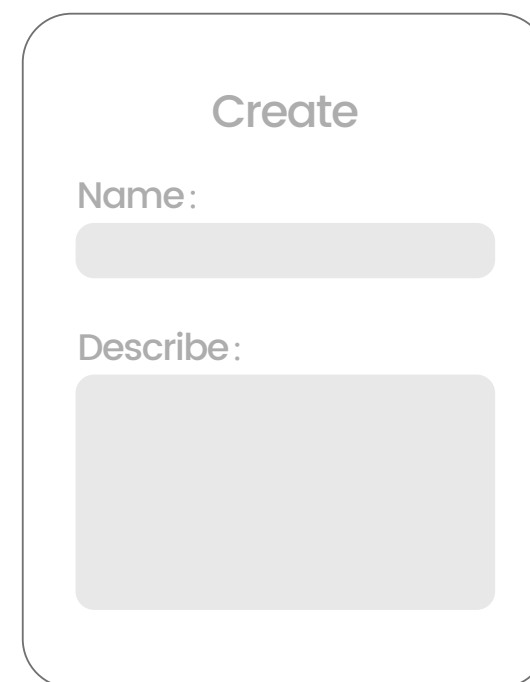

The image shows a 'Create' form for a playlist. It has a title 'Create' at the top. Below the title, there is a label 'Name:' followed by a text input field. Underneath that, there is a label 'Describe:' followed by a larger text area for a description. The form is enclosed in a rounded rectangle.

Name: Enter the Playlist name.

Description: Describe the Playlist.

Batch Create Playlist

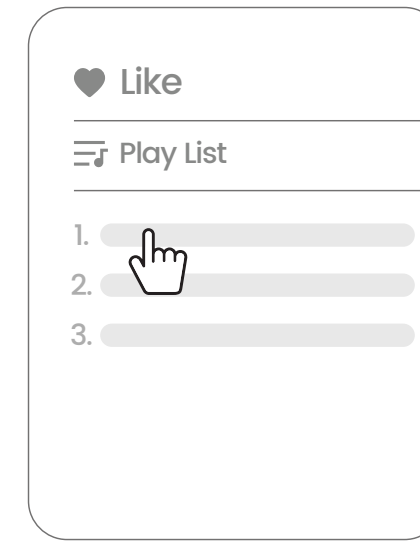
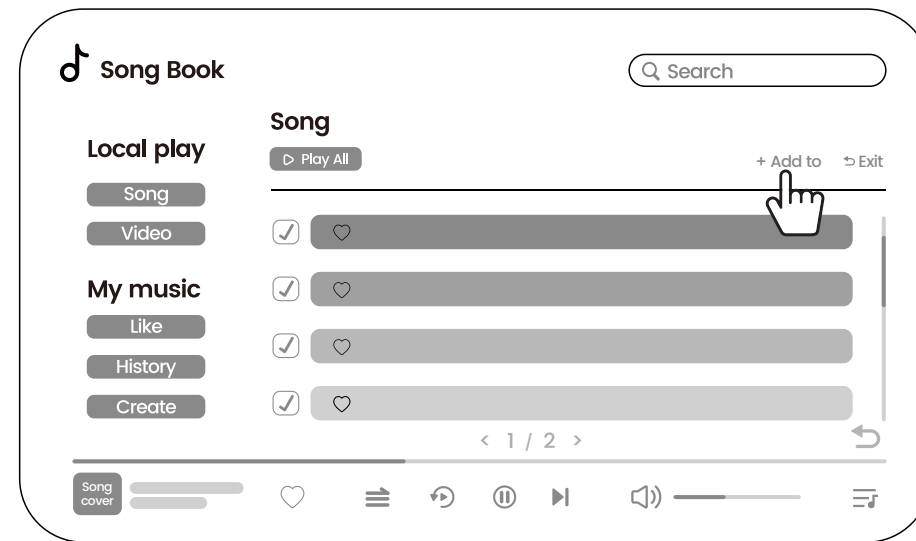
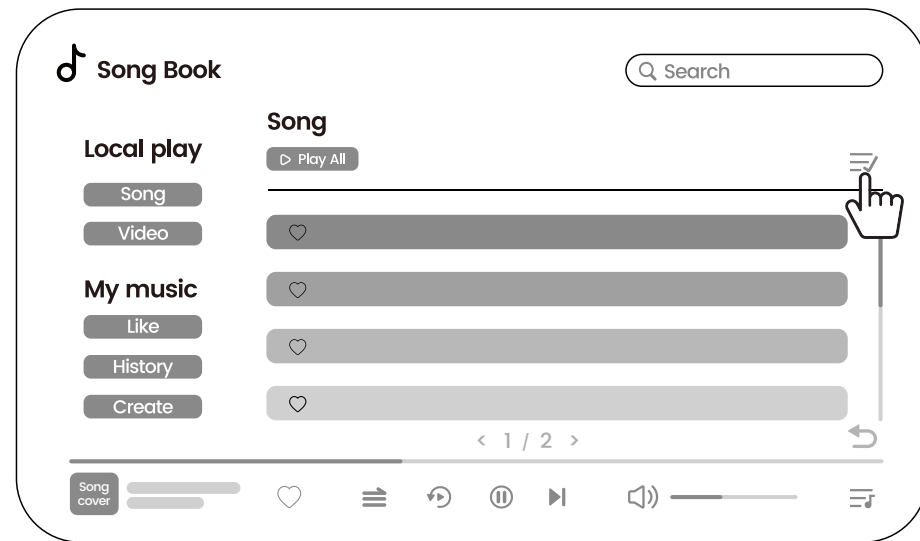

1. Long press on a song or click the list icon in the top right corner to activate batch selection mode.
2. Click the add icon.
3. Select the Playlist to add the tracks.

Page Turning

Click left or right to turn pages.

Quick Jump to Specified Page

Click the page number, enter the page number, and click OK to jump to the specified page.



View Lyrics

Click the song cover on the bottom status bar to enter the song playback page. If an LRC. lyrics file is in the song folder, lyrics will be displayed.

Different Display on External Screen

When connected to an external display, TV, or projector, the Ikarao Break X1's screen and the external screen can display different content.

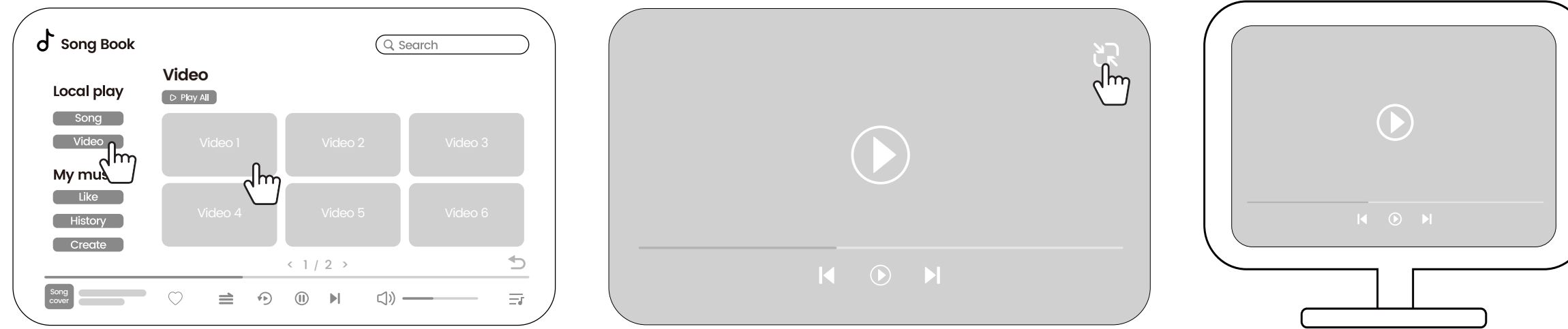

1. Connect the external display.

(See the specific operation on the relevant  Page 19.)

2. Open Local Media Player, go to Video, and tap a Video to play.

3. Click the minimize icon in the top right corner of the video. You can perform other operations without affecting the playback on the external screen.

NOTE: This feature requires app support. Currently, only Local Media Player and KaraFun support this function.

Call Up Control Bar

Swipe left on the blue vertical bar on the right to call up quick controls for Display, Music Mode, Sound, and Lighting Mode.

Bluetooth Instructions

Enter Bluetooth Mode

Click the Bluetooth icon on the screen or press the Playback Mode button to switch to Bluetooth mode. The device will automatically reconnect to previously paired devices within one minute and remain in pairing mode for 10 minutes.

Connect to Bluetooth

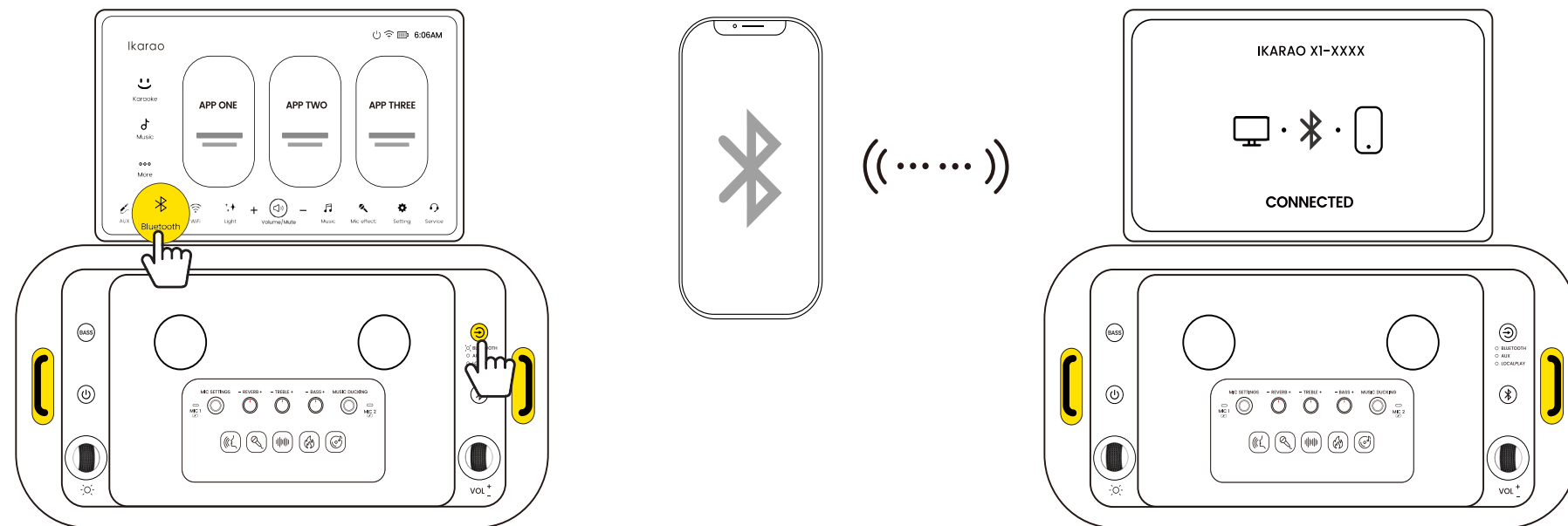

1. Ensure the Bluetooth status is "Bluetooth Pairing".

(if it shows "Bluetooth Connected," refer to [Page 47 - Disconnect Bluetooth](#)).

2. Turn Bluetooth on your device (iPhone, Android, Laptop, iPad, etc.) and find "Ikaroo X1-xxxx" to pair.

3. If the connection times out and the indicator light turns off, short-press the Bluetooth button to re-enter pairing mode.

4. Once paired, the status will change to "Bluetooth Connected."

Disconnect Bluetooth

Press the Bluetooth button on the speaker to disconnect the current Bluetooth connection, changing the status to "Bluetooth Pairing." You can also short press the button to enter pairing mode without accessing the Bluetooth Mode.

Bluetooth Playback With Lyrics Display

If supported by the music app, lyrics will be displayed automatically. Note that many major Western music apps (Apple Music, Spotify, YouTube Music, Amazon Music, Tidal) do not support this feature due to copyright issues.

View Current Bluetooth Connection Device

Enter the Bluetooth mode settings to see the currently connected device and modify the Bluetooth name if needed.

Third-Party APP

Once connected to Wi-Fi, you can use pre-installed third-party apps for Karaoke, listening to music, watching videos, and more.

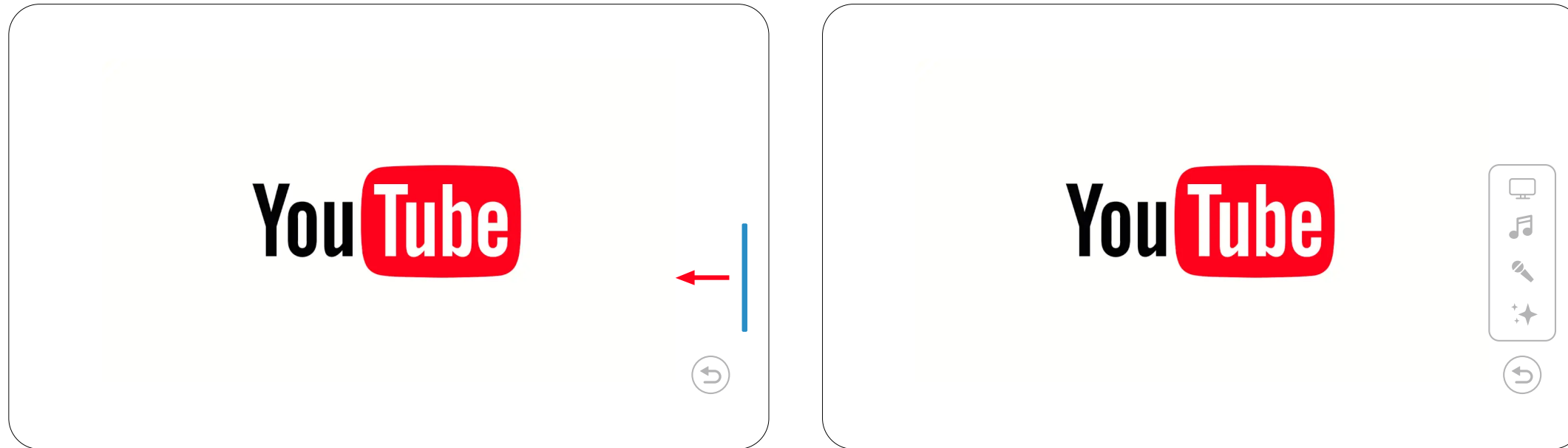

Access Control Bar

Slide the blue vertical bar on the right side of the screen to the left to access quick controls for Display, Music Mode, Sound, and Lighting Mode.

Return to Home From Third-Party Apps

Find the blue return button at the bottom right of the screen. Single-click to go back to the previous page, long-press to return to the home screen.
NOTE: You can drag the return button to any location on the screen.



04 Discover
Repair fault

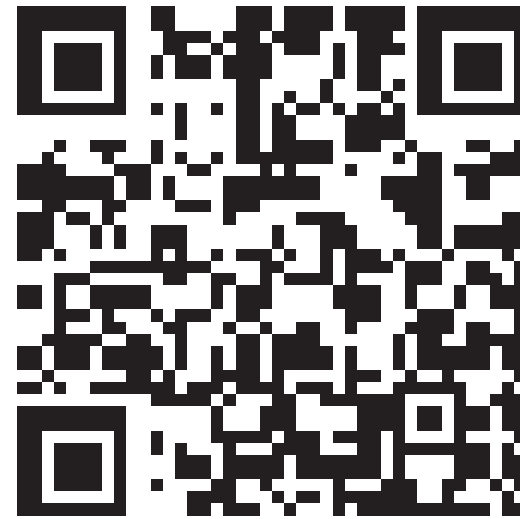

For more after-sales service and information

please visit: www.ikarao.com/pages/support

Network Issues

What to do if Wi-Fi Connection Fails

1. Ensure the router password is correct.
(enable password visibility settings, refer to  Page 36 - WiFi)
2. Place the router and the speaker closer together, avoiding walls.
3. Connect the speaker to a personal hotspot on your phone to check for router compatibility and network issues.
4. If certain routers have compatibility issues, modify the SSID (wireless network name) and password in the router's management settings to a combination of letters and numbers. Also, check the router's whitelist and blacklist settings. Then, reset the speaker and configure the network again.

What to do if Wi-Fi Connects But can't Access the Internet

This might be due to network fluctuations or issues with your modem. Follow these steps:

1. Check if other devices on the same Wi-Fi can connect to the internet. If they can, contact your network administrator or access the router's management settings to see if there are any restrictions.
2. If other devices also can't connect to the internet, check if the router's connections are loose and if the indicator lights are normal (refer to the router manual).
3. Verify that your broadband service is not overdue for payment.

Why does Wi-Fi Disconnect Automatically?

The speaker will attempt to reconnect to Wi-Fi if the network is temporarily lost. If the network recovers quickly, it might be due to router or network provider fluctuations. If the network remains disconnected for a long time, follow these steps:

1. Ensure the router's power is functioning properly.
2. Check if the router's WAN port is properly connected.

3. Confirm if other devices can connect to Wi-Fi and the internet normally.
4. Verify if the router password has changed.
5. Ensure the router and the speaker are not too far apart or separated by walls. Place them closer together if necessary.
6. If none of the above resolves the issue, try restarting the speaker.

Music or Video Playback Stuttering

1. Check Wi-Fi signal strength. Move the speaker closer to the router if the signal is weak.
2. Ensure the Wi-Fi connection is on the 5G frequency band.

(refer to  Page 36 for instructions)

3. Use another device on the same network to access the content. If it still stutters, the issue may be with the source.

Bluetooth Issues

Music Stuttering Over Bluetooth

1. Ensure the source device is playing offline music. Online music might stutter due to network speed or buffering issues.
2. Check the distance between the source device and the speaker. The effective Bluetooth range is generally 10m. Too much distance or a wall can cause stuttering.
3. Ensure there are not too many 2.4GHz devices (e.g., 2.4GHz Wi-Fi routers, phones, smart home devices) nearby, as they can cause interference.
4. Try turning Bluetooth off and on again on the source device, then reconnect.

Unable to Find the Speaker When Pairing Bluetooth

1. Ensure the speaker is powered on and in normal working condition.
2. Make sure the speaker is in Bluetooth audio mode by pressing the Bluetooth button or switching to Bluetooth mode.

3. Ensure there are not too many devices connected to a 2.4GHz Wi-Fi band in the room. Interference can occur. Try connecting the speaker to a 5GHz band.
4. Restart the phone's Bluetooth and try again if there is a system issue.

Bluetooth Fails to Connect Initially Despite Finding the Speaker

1. Check if the speaker is already connected to another Bluetooth device.

(Refer to  Page 46-47 for detailed steps.)

2. Press the Bluetooth button to re-enter pairing mode and try connecting again.

Bluetooth Reconnection Fails

If the phone previously connected to the speaker but now fails to reconnect, go to the phone's settings: **Settings > Bluetooth > My Devices**, forget the previously connected speaker, and try connecting again.

Displaying Lyrics via Bluetooth

Displaying lyrics over Bluetooth requires music app support. Most major music apps in Western regions do not support this feature due to copyright issues, including Apple Music, Spotify, YouTube Music, Amazon Music, and Tidal.

Microphone Issues

No Sound from Microphone

1. Check if the microphone is successfully connected. A solid blue indicator light, a microphone icon on the screen, and the ability to switch microphone effects by pressing the power button indicate a successful connection.
2. If not connected, restart the microphone and try reconnecting. If connected but still no sound, try moving the main unit away from other 2.4GHz devices and restart.

Music Volume Drops When Singing with Microphone

Check if the Music Ducking feature is accidentally enabled

(refer to  page 16 . This feature prioritizes vocals by automatically lowering the music volume.)

Microphone Won't Turn On

1. Ensure you are holding the power button for at least 2 seconds.
2. If it still won't turn on, try charging the microphone. Ensure the speaker has sufficient battery or is connected to a power source. The charging indicator on the microphone should light up while charging.

Local Media Player Issues

Playing Music from TF Card, USB Drive, or External Hard Drive

1. Insert the TF card, USB drive, or external hard drive into the corresponding port.
2. A prompt will appear on the screen: "USB Drive: The machine detects the insertion of USB, do you want to enter the local media?" Click Yes.
3. If you accidentally click No, go to **MUSIC > LOCAL MEDIA** to access the local media player.

No Lyrics in Local Media Player

The local media player requires an LRC file to display lyrics. Ensure the LRC file name matches the music file name except for the extension. For example, if the music file is named "Love The Way You Lie.mp3," the lyrics file should be named "Love The Way You Lie.lrc."



05

**Technical
Notes**

Safety Instructions

Ensure proper use of the product. Please read your User Manual carefully before use, especially the following safety instructions.

General Safety Tips:

1. Avoid extreme high or low temperatures.
2. Keep away from moisture, rain, or other liquids.
3. Do not expose to direct sunlight.
4. Avoid dropping or severe impacts.

Battery and Charging:

1. Use the specified charger and power cable.
2. Keep away from flammable materials while charging.
3. Do not attempt to replace the battery yourself.
4. Avoid overcharging or completely discharging the battery.

Electrical Safety:

1. Ensure the power outlet meets the product requirements.
2. Avoid contact with live electrical parts.
3. Do not use in a damp environment.

Health and Environment:

1. Prolonged use may cause eye strain or other health issues; take regular breaks.
2. Do not use while driving or operating machinery.

3. Do not dispose of it improperly; follow local recycling regulations.

Child Safety:

1. Small parts may pose a choking hazard; keep away from children.
2. Children should use the product under adult supervision.

Radiation and Interference:

1. The product may cause electromagnetic interference; avoid using it near sensitive equipment.
2. Comply with local regulations regarding RF devices.

Maintenance and Cleaning:

1. Turn off the power and unplug before cleaning.
2. Do not use corrosive cleaning agents.

Emergency Handling:

1. If the product emits smoke, odor, or shows any abnormal condition, stop using it immediately and disconnect the power.
2. If the battery swells or leaks, avoid direct contact and follow local disposal regulations.

Battery and Power

This section describes the correct usage of the battery and methods to extend its lifespan. Improper use can shorten battery life or cause leakage, overheating, fire, or explosion.

Battery Usage

1. Idle batteries gradually lose charge. Recharge the battery within a day or two before use. Turn off the product when not in use to extend battery life.
2. Battery performance declines in cold environments; low-charge batteries may not work properly in cold conditions.

Charging

1. Use the provided adapter or power cable for charging. Charging time increases when the temperature is below +10°C or above +35°C. Do not charge the product when the temperature is above +40°C or below +5°C.
2. It is normal for the product to heat up during charging or after use.
3. To maintain battery health, charge the battery at least once every three months.

Battery Life

1. When the product's battery life noticeably decreases, the battery has reached the end of its life and needs to be replaced. Contact the Ikarao support team or a dealer for replacement.
2. Long periods without charging can degrade battery quality. Regularly charge the battery.

Storage

For long-term storage, charge the battery to about 1/2 to 2/3 capacity and store it at room temperature.

Adapter or Power Cable

1. The AC power adapter is for indoor use only.
2. Ensure the cable is securely connected to the speaker.
3. Turn off the speaker before disconnecting the adapter.
4. Do not disassemble the adapter.
5. Avoid placing the adapter in high-temperature or humid areas.
6. Do not subject the adapter to strong shocks.
7. It is normal for the adapter to make a humming noise or become warm during use.

Screen Use

1. If the display screen is damaged, avoid contact with the liquid crystal. In case of any of the following incidents, take the specified emergency measures.
2. Skin Contact: Clean the area with a cloth, apply soap, and wash thoroughly with water.
3. Eye Contact: Rinse the affected eye with clean water for at least 15 minutes and seek medical help.
4. Ingestion: Rinse your mouth thoroughly with water, drink a large amount of water to induce vomiting, and seek medical help.

Certifications and Declarations



Tested To Comply With FCC Standards
FOR HOME OR OFFICE USE
Contains FCC ID:2BCRN-BREAKX1

FCC Statement: This device complies with Part 15 of the FCC Rules. Operation is subject to the following two conditions:

1. This device may not cause harmful interference,
2. And this device must accept any interference received, including interference that may cause undesired operation.

FCC WARNING: Changes or modifications not expressly approved by the party responsible for compliance could void the user's authority to operate this equipment.

Radiation Exposure Statement(Only for speaker): This equipment complies with FCC radiation exposure limits set forth for uncontrolled environment. This equipment should be installed and operated with minimum distance of 20 cm between the radiation & your body.



Dongguan Aika Electronic Technology Co., Ltd. Declares that this product is in compliance with Directives 2014/53EU and all other applicable EU directive requirements. The complete declaration of conformity can be found at: www.ikarao.com



The Bluetooth® word mark and logos are registered trademarks owned by Bluetooth SIG, Inc. and any use of such marks by Dongguan Aika Electronic Technology Co., Ltd. is under license. Other trademarks and trade names are those of their respective owners.

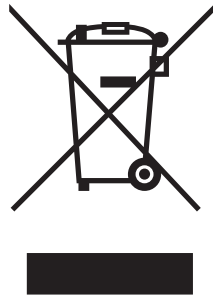

This symbol means the product must not be discarded as household waste, and should be delivered to an appropriate collection facility for recycling. Follow local rules and never dispose of the product and rechargeable batteries with normal household waste. Correct disposal of old products and rechargeable batteries helps prevent negative consequences for the environment and human health.



The KC (Korea Certification) mark signifies compliance with Korea's product safety requirements for electrical and electronic equipment and is issued by Korea-based certification bodies that have been approved by the Korea Standards Association.



The UL mark shows the product is tested by UL and meets UL Standards of Safety for the U.S.

Technical Specifications

Dimensions:	50cm*27.5cm*25.3cm
Weight:	Approx. 11.8kg, including two wireless microphones
Speaker Dimensions:	Woofer: 6.5 inches * 1 Tweeter: 2.6 inches * 2
Frequency Response:	45HZ-20KHz
Speaker SPL:	107dB
Suitable for areas :	15-200m ² 150-2000 ft ²
Output Power:	80W+10Wx2
Bluetooth Version:	V5.4
Wi-Fi Protocol:	802.11ac/b/g/n
Signal-to-Noise Ratio (20K LPF):	≥ 95dBA(Rated power)
Screen Size:	13.3 inch
CPU:	Quad-core Cortex-A55
RAM:	2GB
EMMC:	64GB
Input:	AC: 100V-240V/2A 50-60Hz
Standby Power Consumption:	≤ 0.5W

Speaker Charging Time:	≤ 4H
Speaker Battery Life:	≥ 6H(screen on), ≥ 10H(screen off)
Microphone Charging Time:	≤ 5H
Microphone Battery Life:	≥ 30H
Microphone Type:	Dynamic
Microphone Size:	2*Φ35×H183mm
Microphone Battery Capacity:	1500mAH
Microphone Distortion:	≤ 1%
Microphone Frequency Response(By-Pass)	60Hz-12KHz (±1.5dB)

NOTE:Specifications and performance are subject to change without notice. Ikarao will not be held liable for any errors this manual may contain. The appearance of the product may differ from that described in this manual.

Ikarao[®]

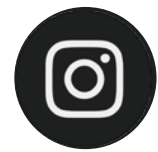

@ikaraoofficial



@IKARAO



@IKARAO



@IKARAO



@ikaraoofficial