

KENT *Gold*

UF Membrane
Storage Water Purifier

Instruction Handbook for Installation, Operation and Maintenance



System Tested and
Certified by NSF
International against
NSF/ANSI Standard
53 for the reduction
of Cyst



"System tested &
certified by WQA to WQA
S-200 for the reduction
of Chlorine Taste and
Odor, and Cyst, as
verified and substantiated
by test data."



KENT
UF Membrane
Water Purifiers

HOUSE of PURITY

Welcome TO KENT

Dear Customer,

Welcome to the world of KENT, the leaders of water purification industry in India. With a KENT's product you have all reasons to smile, since at KENT, we take pride in the quality and laboratory-tested performance of our products.

We are confident that your decision to own KENT Gold UF Storage Water Purifier will go a long way in serving you with safe and clean drinking water – thus keeping you and your family in good health. We assure you that you will be satisfied with its performance and quality, which comes without any compromise.

This manual is an effort towards familiarizing you with the operation and maintenance of KENT Gold. Before operating the unit, please read it thoroughly and retain it for future reference. Should you need further assistance or information, do not hesitate to contact your nearest KENT dealer or branch.

Best wishes,

KENT RO SYSTEMS LTD.



Terms & Conditions of Warranty

KENT warrants all new products manufactured by it to be free from defects in material and workmanship under normal usage and service from the date of purchase as under:

1. The Warranty period commences from the date of purchase by the first end-user. During this Warranty period of one year, KENT or its Authorised Service provider (ASP) will replace or repair any part of the KENT water purifier, that in the opinion of KENT or its ASP, would be defective in operation due to faulty material or workmanship (i.e. manufacturing defects) with the exception of consumables such as Sediment Filter, Carbon Filter and UF Membrane. However, if the UF Membrane gets clogged within first six months, it shall be cleaned / repaired / replaced at no extra charge.
2. The product's plastic body is not covered under Warranty and hence, it must be handled with care to guard against breakage.
3. The original purchaser of the unit can avail services under Warranty at the point of sale, by producing the damaged part(s) along with the original invoice.
4. This Warranty is void if the unit is not operated under normal municipal water or well water conditions or subjected to the temperature above 35°C.
5. Product returned to KENT or its ASP for Warranty examination must be shipped freight prepaid.
6. KENT or its ASP shall not be held liable for claims exceeding the cost of repair of the defects in workmanship.
7. This Warranty Agreement shall not be interpreted to render KENT or its ASP liable for injuries or damages of any kind - direct, consequential or contingent to persons or property.
8. KENT or its ASP shall not be held responsible by representative or buyer for failure to abide by any of the obligations of this Warranty Agreement if such failures are the result of circumstances of Forces Majeures: such as, but not limited to, floods, earthquakes, transportation strikes, labour disputes with outside suppliers or any other conditions beyond the control of KENT or its ASP.
9. KENT or its ASP shall not be held liable for repair or alterations made without prior written approval; for products clogged by suspended matter, precipitates or biological growth; or for failures resulting from the lack of proper maintenance.
10. KENT or its ASP cannot and shall not be held liable for any sickness or illness due to the consumption of drinking water from any water purifier supplied by KENT, since KENT or its ASP does not have any control over the maintenance and usage of water purifier.
11. This Warranty Agreement excludes all products/ component parts or damage to any part of this water purifier which, in the opinion of KENT or its ASP, have been subjected to misuse; misapplication; negligence; alteration; accident or operation contrary to our instructions, incompatibility with accessories not installed by KENT or its ASP, or that have been repaired with component parts other than those manufactured by or obtained from KENT or its ASP. Damage caused by freezing, flood, fire or Act of God is not covered by this Warranty. In all such cases regular charges will apply. This limited Warranty does not include service to diagnose a claimed malfunction in this unit.
12. KENT reserves the right to alter or improve design and specifications at any time, without any contingent obligations to prospective buyers or owners of the products previously sold.
13. Any disagreements and obligations based upon the purchase of KENT products and thereby imposed on KENT or its ASP shall be governed by and construed according to the laws of INDIA and subject to the jurisdiction of Delhi Courts only.
14. KENT or its ASP assumes no Warranty liability in connection with this water purifier other than that specified herein. This Warranty is in lieu of all other warranties, expressed or implied, including warranties of fitness for a particular purpose. KENT or its ASP does not authorize any person or representative to assume for them any other obligations on the sale of this water purifier.
15. Under no circumstances are the terms mentioned above negotiable and no employee of KENT or its ASP has the authority to supersede them.

Contents

1. Introduction	5
2. Items in the box	5
3. Salient features	6
4. Technical specifications	6
5. Know your KENT Gold	7
6. Exploded view of KENT Gold	8
7. Important instructions	9
8. Filtration process	9
9. Setting up your KENT Gold	10
10. Maintaining your KENT Gold	11
Part 1:- Cleaning the UF Membrane	11
Part 2:- Cleaning the water tanks	12
Part 3:- Cleaning the Sediment & Carbon Filters	12
Part 4:- Replacing the Sediment Filter	13
Part 5:- Replacing the Carbon Filter	13
Part 6:- Replacing the UF Membrane	14
Part 7:- Restoring your KENT Gold (when leaving for long vacations)	15

Introduction

Presenting the all-new KENT Gold UF Membrane Storage Water Purifier, which gives you truly pure water and protects your family against water-borne diseases. With innovative KENT Gold, dependence on electricity and usage of chemicals to obtain pure drinking water are now problems of past.

At the heart of KENT Gold is a state-of-the-art Hollow Fiber UF (Ultra Filtration) Membrane. The pores of this UF Membrane are so fine that they do not allow any Bacteria (certified by Toray, Japan) and Cyst (certified by NSF International) to pass through. This makes the drinking water pure without use of any chemicals like Chlorine, Bromine or Iodine.

Items in the box

Please verify the following items in the packaged box:

1. Bottom Tank	1 no.
2. Top Tank	1 no.
3. Bottom Stand	1 no.
4. Middle Partition	1 no.
5. Top Cover	1 no.
6. Top Lid	1 no.
7. Carbon Assembly with Inlet Funnel	1 set
8. Hollow Fiber UF Membrane Cartridge	1 no.
9. Spare Sediment Filter	1 set
10. 50ml Cleaning Syringe	1 no.
11. Membrane Fitting Pusher	1 no.
12. Instruction Manual	1 no.

Salient Features

- Ideal for water from most sources (preferably low TDS water)
- Use of Hollow Fiber UF Membrane removes Bacteria (certified by Toray, Japan) as well as Cyst (certified by NSF International). Cysts are the deadly pathogens that cannot be removed by most non-electric storage water purifiers.
- No use of chemicals such as Chlorine, Bromine or Iodine for purification. Thereby, provides healthier and tastier drinking water.
- Use of Nano-Silver Carbon for better disinfection of water.
- Designed with a high Bottom Stand so that a glass can be filled easily and the purifier is not bound to be placed on the edge of a table/slab.
- Very high storage capacity of 20 litres (13 litres in the Bottom Tank and 7 litres in the Top Tank), which makes purified water available on demand.
- Food grade plastic construction for trouble free maintenance and long life.

Technical Specifications

Marketed By	: KENT RO Systems Ltd. A-2, Sector-59, Noida, U.P.- 201 309, India Ph.: +91-120-3075075
Model	: KENT Gold (UF Membrane Storage Water Purifier)
Model No.	: 1046
Mounting	: Table top
Dimensions	: 600 (L) x 355 (W) x 326 (H) (when assembled)
Bottom tank storage capacity	: 13 litres
Upper tank storage capacity	: 7 litres
Membrane type	: Hollow Fiber Hydrophilic UF Membrane
Filters	: Sediment, Silver Carbon, SS Screen
Expected life of UF Membrane	: 4000 litres/1058 gallons
Expected life of Carbon Filter	: 900 litres/238 gallons
Maximum Operating Water Temperature	: 35 °C/113°F
Minimum Operating Water Temperature	: 10 °C/32.2°F
Filtration Capacity	: 0.31 litre per minute (under standard testing conditions)

This system has been tested under NSF/ANSI 53 for reduction of the substances listed below. The concentration of the indicated substances in water entering the system was reduced to a concentration less than or equal to the permissible limit for water leaving the system, as specified in NSF/ANSI 53.

Substance	Influent challenge concentration	Reduction requirement
cyst	minimum 50,000/L	99.95%

Percentage of Cyst Reduction after testing : 99.96% reduction

(Though testing was performed under standard laboratory conditions, actual performance may vary.)

Know your KENT Gold

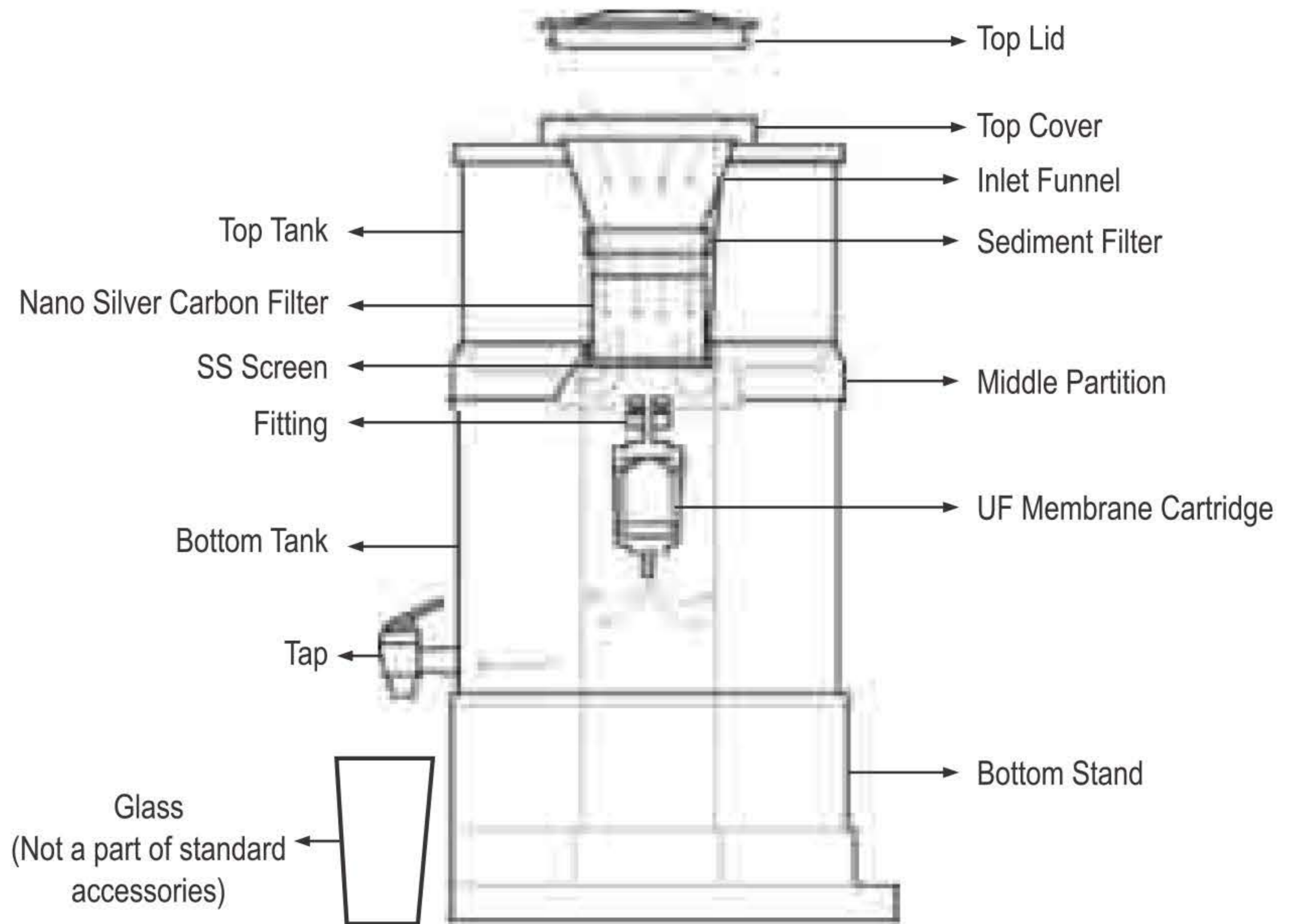

Exploded view of KENT Gold

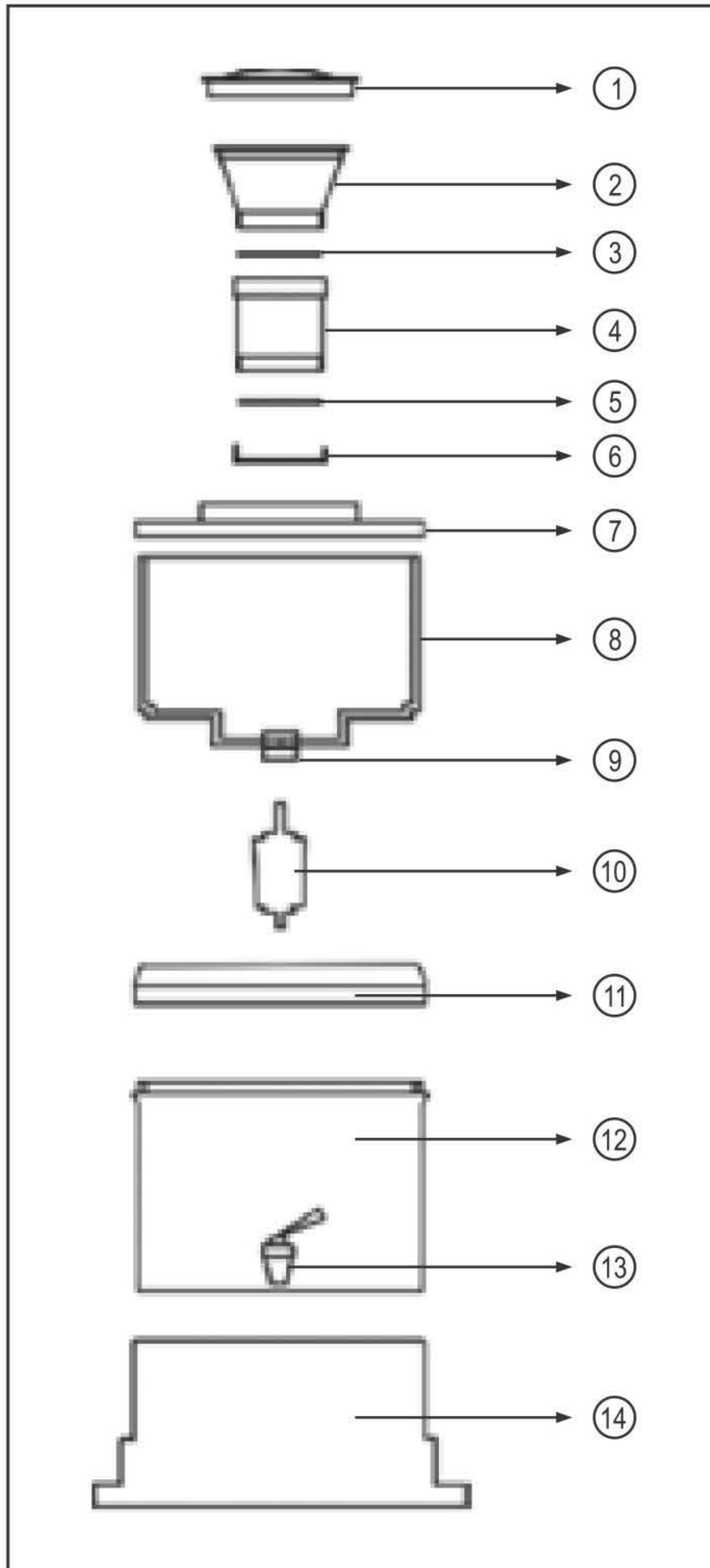

1. Top Lid
2. Inlet Funnel
3. Sediment Filter
4. Nano Silver Carbon Filter
5. SS Screen
6. Carbon Filter Housing Cap
7. Top Lid
8. Top Tank
9. Fitting
10. UF Membrane Cartridge
11. Middle Partition
12. Bottom Tank
13. Tap
14. Bottom Stand

Important Instructions

1. Avoid exposure to direct sunlight as overheating can damage the purifier's plastic body.
2. Do not confine the purifier in a cabinet.
3. Keep both the storage tanks clean. They should be washed and properly rinsed once in 7 days with purified water.
4. The Sediment and Carbon filters should be cleaned at least once in 30 days or earlier, as per the quality of tap water. (May be weekly, if the water is dirty)
5. The UF Membrane should be backwashed at least once in 30 days or earlier, as per the quality of tap water. (May be weekly, if the water is dirty)
6. The Sediment Filter must be changed after every 3 months.
7. The Carbon Filter must be changed after every 6 months.
8. The UF Membrane must be changed once in 12 months.
9. Do not fill the water in the Top Tank if the water level in the Bottom Tank is above the maximum permissible level mark, otherwise it will result in overflow.
10. On the date of installation, note down the date of next change for Filters and Membrane (as advised in nos. 6, 7 & 8 above) on the sticker placed on the rear side of the purifier. This will help you in remembering the dates of change for the respective parts.
11. The system should be used only with cold water.
12. Do not use water that is microbiological unsafe or of unknown quality without adequate disinfection before or after the system. System certified for Cyst reduction may be used on disinfected waters that may contain filterable cyst.
13. Systems certified for cysts reduction may be used on disinfected waters that may contain filterable cysts.
14. The system and installation shall comply with applicable state and location requirements.





Filtration Process

Water from most sources (preferably low TDS water) is filled in the Top Tank, which has a capacity of 7 litres. Water on being filled up passes through the Sediment Filter which removes the suspended impurities. It then passes through silver impregnated carbon granules, which remove organic/chemical impurities such as chlorine, bad taste and odour.

The filtered water gets collected in the Top Tank, and then percolates down through the UF membrane into the Bottom Tank. During this process, most of the bacteria (certified by Toray, Japan) and cysts (certified by NSF International) are removed and only clean & safe drinking water is allowed to pass through. This purified water collects in the Bottom Tank, from where it can be dispensed for drinking.

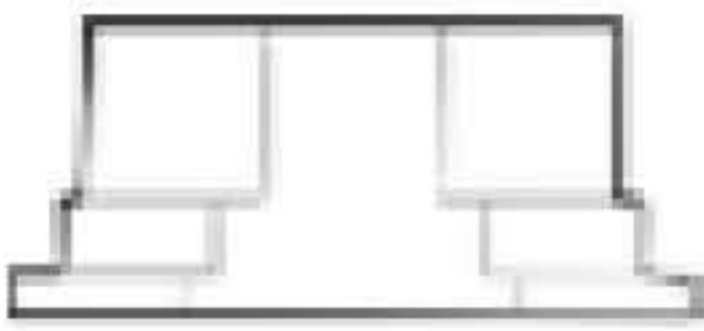
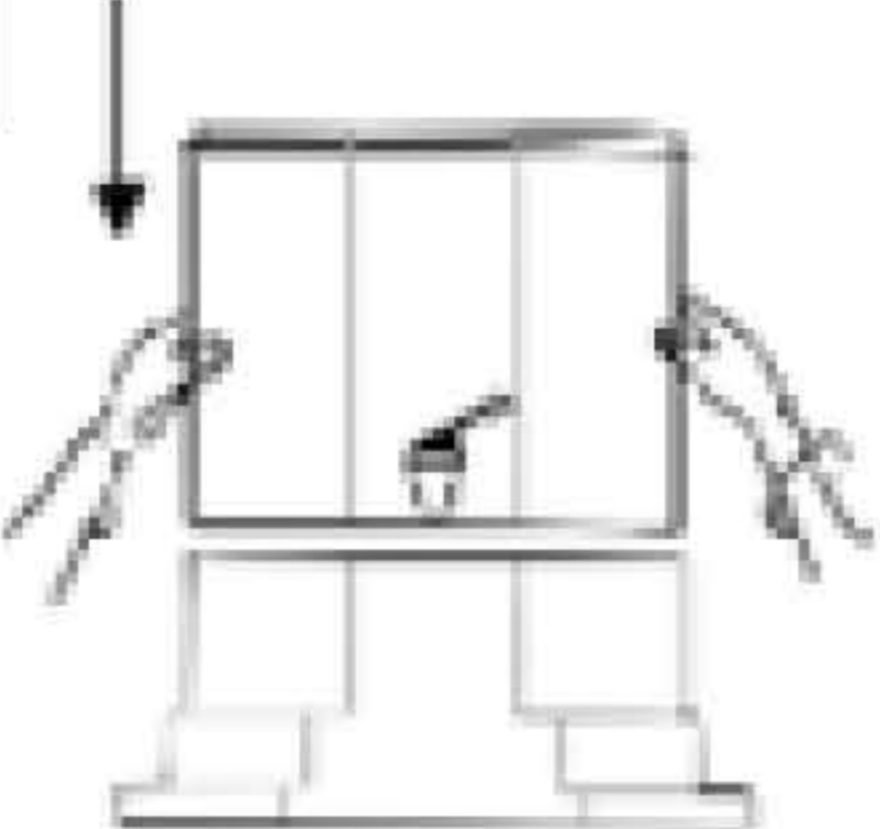
Setting up your KENT Gold

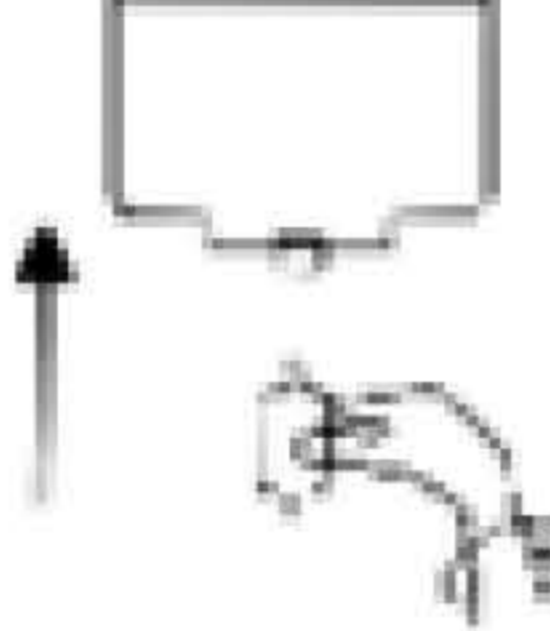
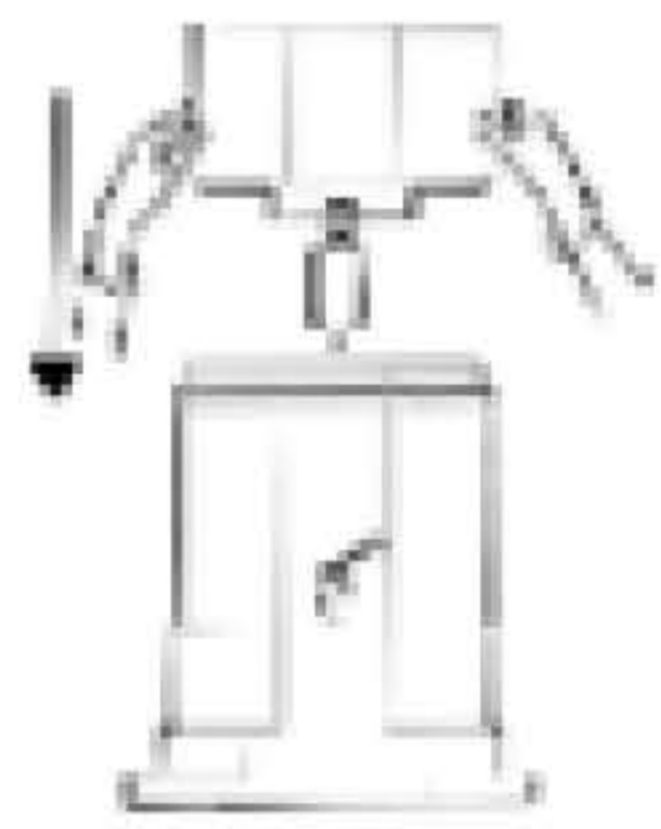
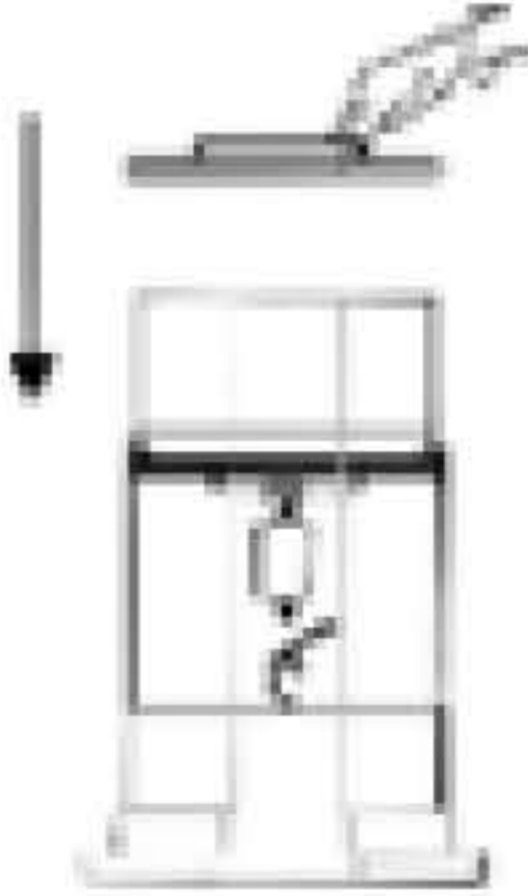

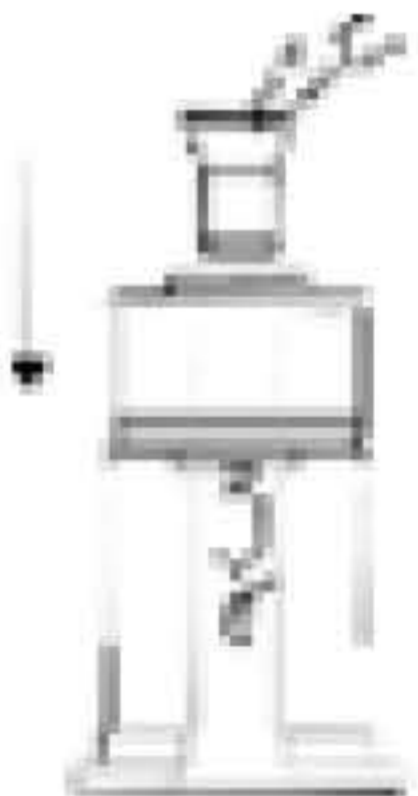
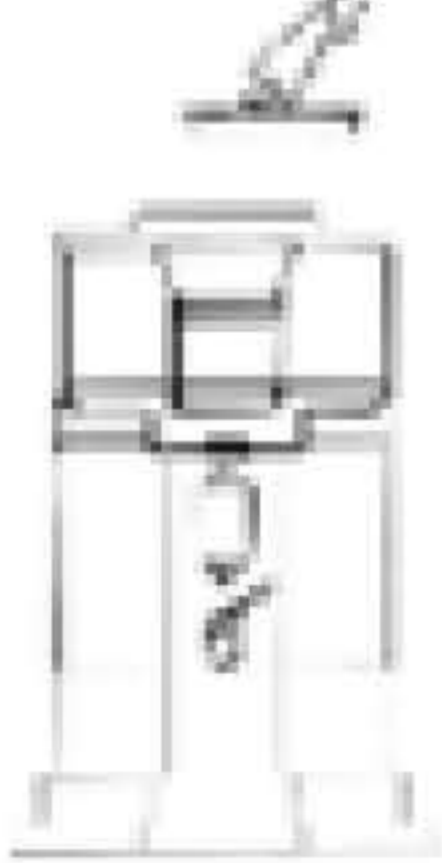
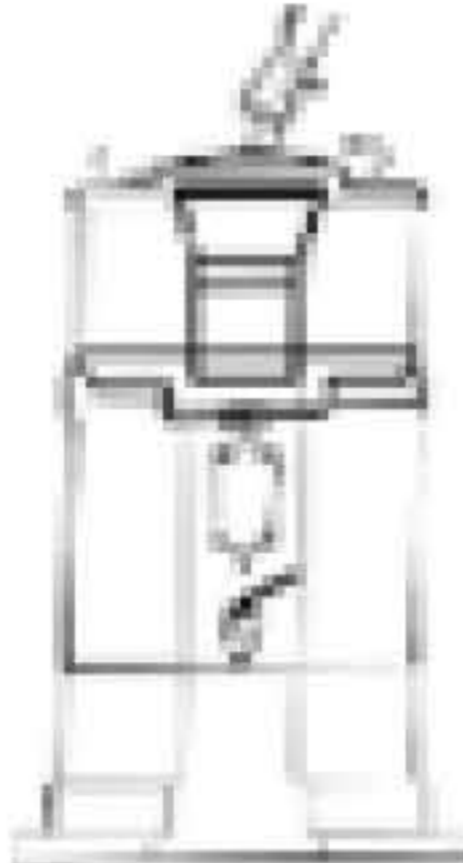
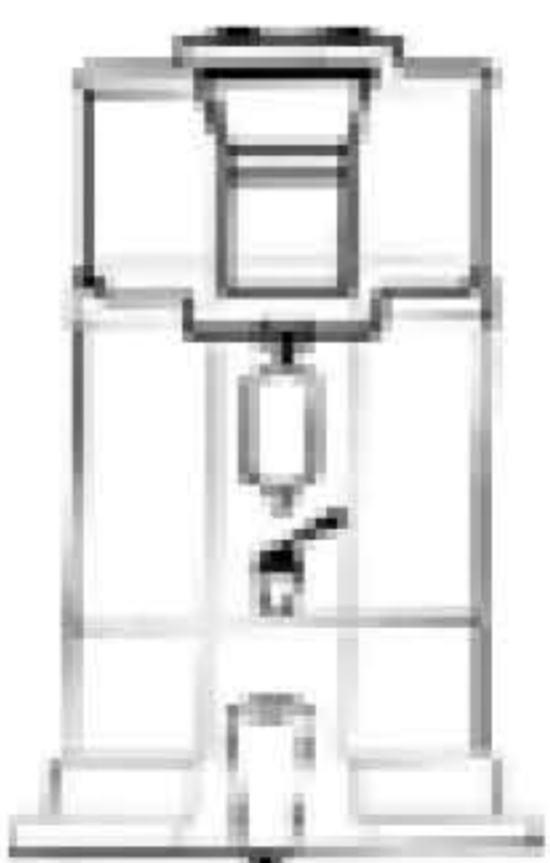
Open the box and remove the parts. Tally the contents with the 'Items in the Box' list (page no. 5). Wash all the plastic parts with clean water and wipe dry with a clean cloth before assembling.

<p>1</p>  <p>Place the Bottom Stand on a flat surface.</p>	<p>2</p>  <p>Place the Bottom Tank on top of the Bottom Stand.</p>	<p>3</p>  <p>Place the Middle Partition on top of the Bottom Tank.</p>
<p>4</p>  <p>Take 50 ml of pure water in the syringe and inject it inside the membrane cartridge (opposite to the direction of flow) to wet the new membrane.</p>	<p>5</p>  <p>Push-fit by pressing the UF Membrane into the fitting of Top Tank. Important: Take precaution to insert the UF Membrane in the direction opposite to that of the water flow.</p>	<p>6</p>  <p>Place the Top Tank with the UF Membrane on the Middle Partition.</p>
<p>7</p>  <p>Place the top cover on the Top Tank.</p>	<p>8</p>  <p>Before Installing the Filter assembly, wash it under a running tap (shake if required) to remove Carbon particles from the new Filter.</p>	<p>9</p>  <p>Install the Inlet Funnel with Sediment and Carbon Filter assembly.</p>
<p>10</p>  <p>Place the Top Lid on top of the tank.</p>	<p>11</p>  <p>Tighten the Top Lid by pressing it down and rotating it clockwise.</p>	<p>12</p>  <p>The Purifier assembly is now ready.</p>

- After assembly, kindly wait till the filtration is complete.
- Water which gets collected in the Bottom Tank, for the first time, should be drained. (Even if all parts are washed thoroughly before installation)
- Once the Top Tank is empty, fill it again but only after checking the level of water in the Bottom Tank.
- If the water level in the Bottom Tank is above the maximum permitted level, please do not fill the Top Tank. (However, you can completely fill the Top Tank if the level of water in the Bottom Tank is below the maximum level mark.)
- For refilling the purifier, rotate the Top Lid and remove it. Pour the unpurified water slowly into the Inlet funnel, ensuring that water does not overflow.
- Initially, Sediment Filter will take approximately 2 minutes to filter 7 litres of unpurified water. (With regular usage, the time taken for filtration may increase. At that stage, the filter must be cleaned.)
- After filling the Top Tank, close the Top Lid.

Maintaining your KENT Gold

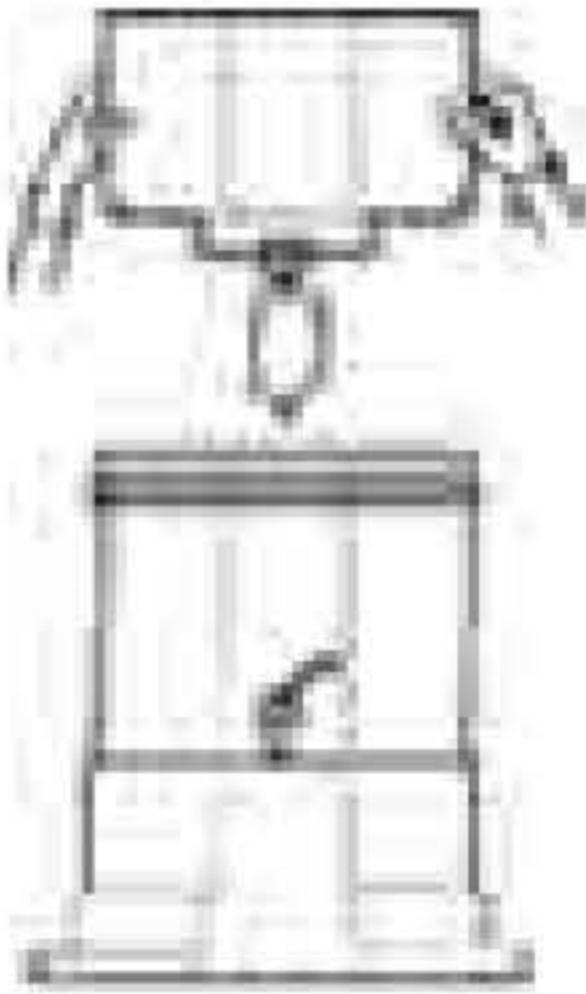
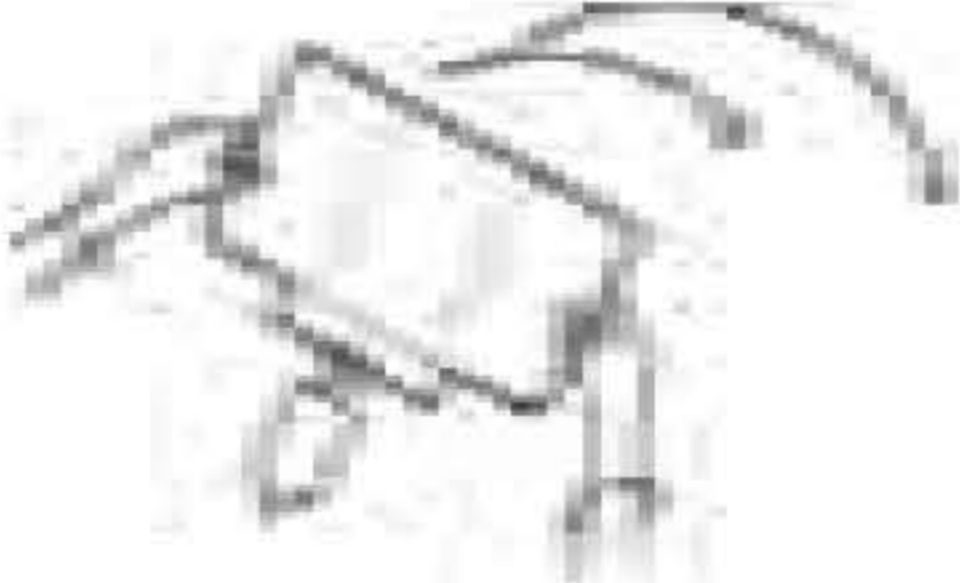
Part 1: Cleaning of UF Membrane





<p>1</p>  <p>Remove the Top Tank.</p>	<p>2</p>  <p>Turn the Top Tank upside down.</p>	<p>3</p>  <p>Place it on a horizontal surface; Take 50 ml of pure water in the given syringe. Fit the syringe into the opening of the membrane cartridge and slowly discharge water from the syringe into the cartridge (back-flushing). Doing this once is sufficient. However, repeat if required.</p>
---	--	--

Frequency:

- The UF Membrane should be cleaned at least once a month. However, if the water flow from Top Tank to the Bottom Tank reduces markedly during this period, the Membrane can be cleaned even earlier.
- It is important to change the UF Membrane once a year.
- For all the replacement element such as Sediment Filter, Carbon Filter, UF Membrane etc., kindly contact authorised dealers of KENT RO Systems Ltd. Or Customer Care as per the address given on the back of the booklet.
- Replacement of spare parts are as under:-

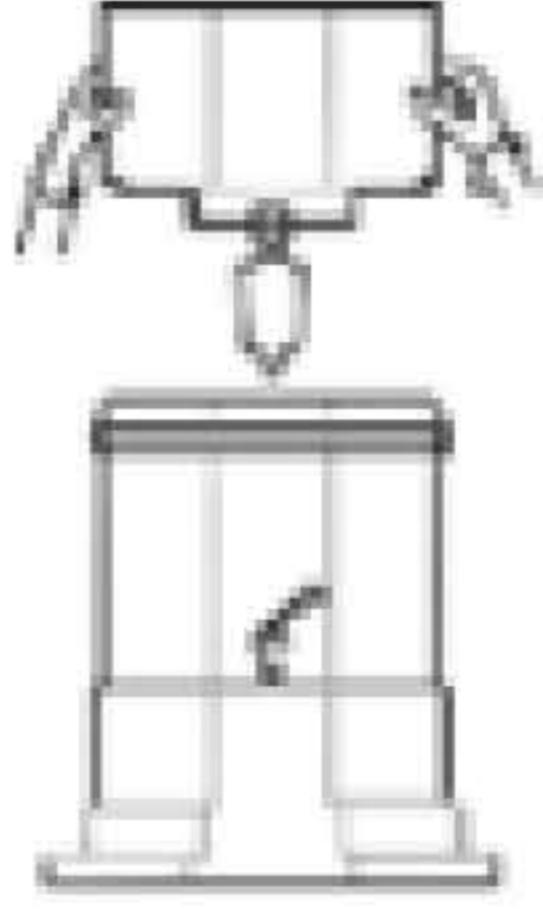

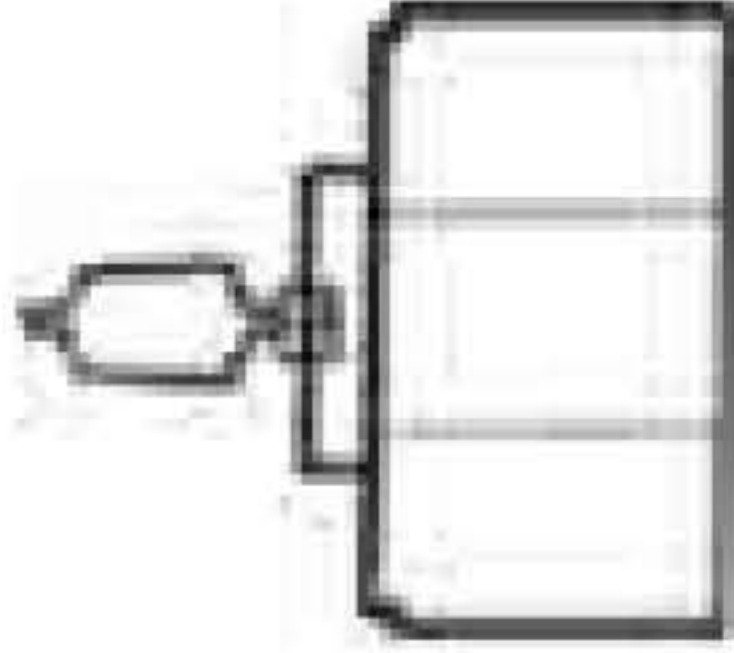
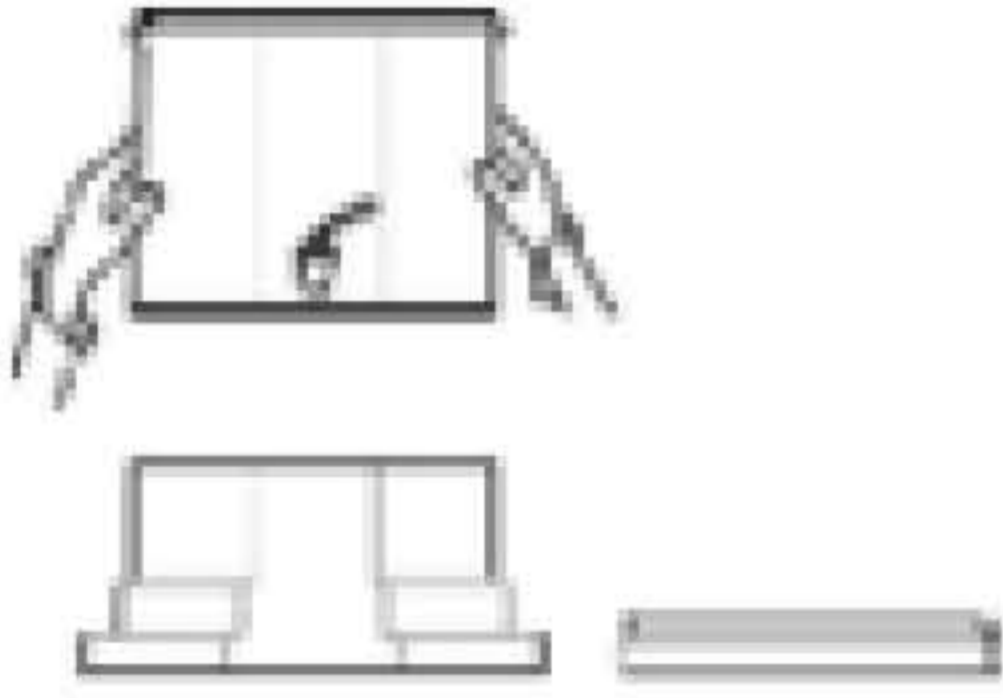
	SPARE CODE :	DESCRIPTION
1871	1596	: SP UF Membrane KENT Gold
	1688	: SP Activated Carbon 185 gm.
	1700	: SP Sediment Filter KENT Gold

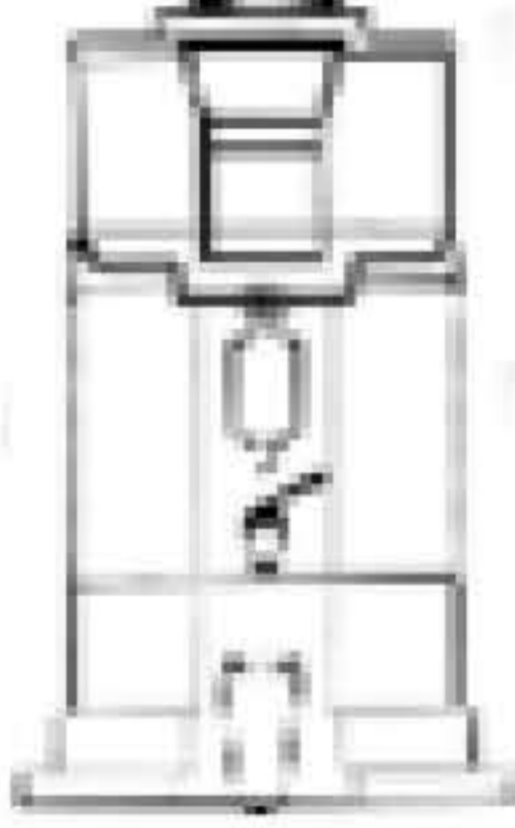
Part 2: Cleaning the Water Tanks

<p>1</p>  <p>Remove the Top Tank.</p>	<p>2</p>  <p>Place it under a running tap or pour water from a jug, and shake for cleaning.</p>	<p>3</p>  <p>Keep it aside.</p>
<p>4</p>  <p>Now, remove the Middle Partition & lift up the Bottom Tank.</p>	<p>5</p>  <p>Place the Bottom Tank under a running tap or pour water from a jug, and clean by shaking it.</p>	<p>6</p>  <p>Now, re-assemble all the parts. (As shown on page no. 6)</p>



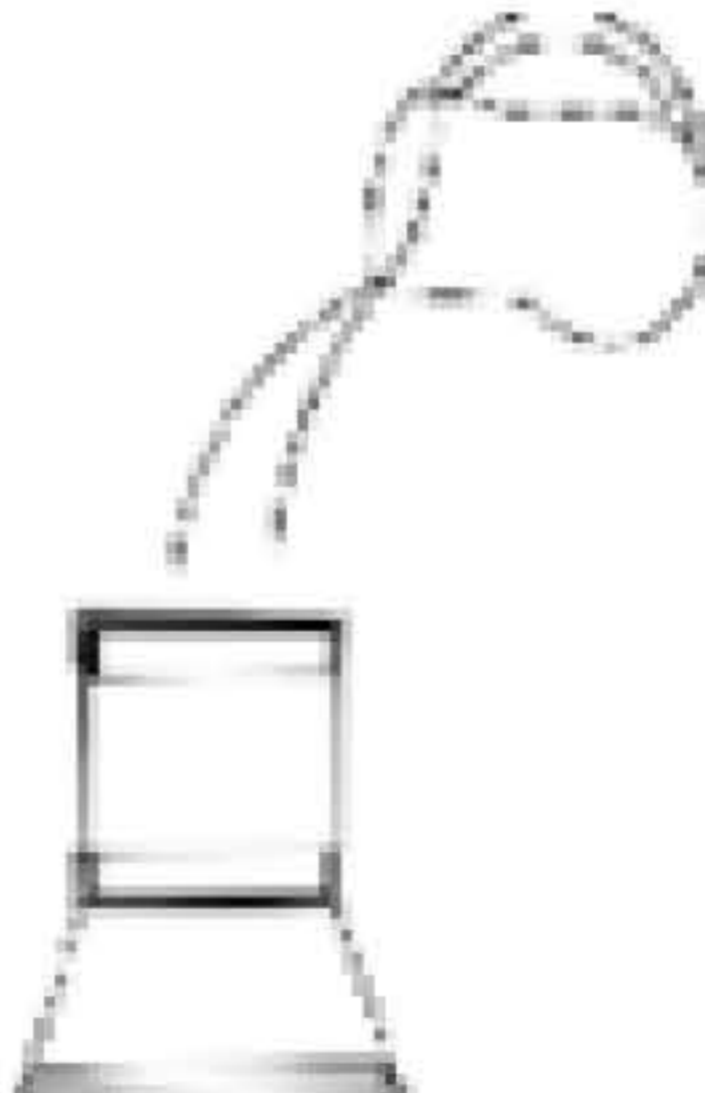
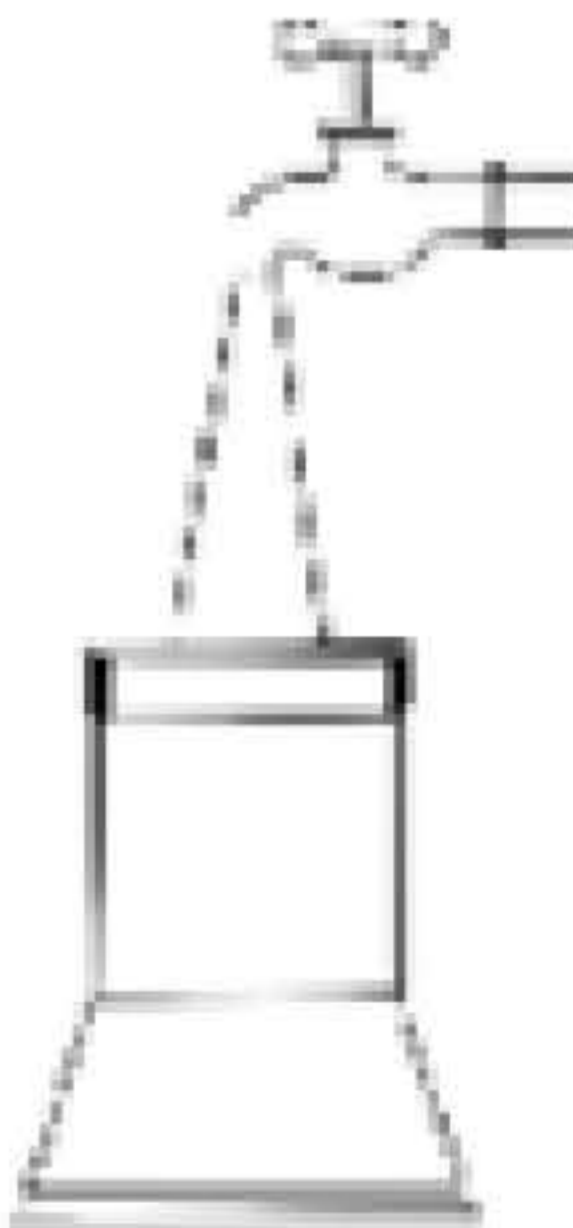

Frequency: Both water tanks must be cleaned once a week.

Part 3: Cleaning the Sediment & Carbon Filters

<p>1</p>  <p>Remove both Sediment & Carbon Filters.</p>	<p>2</p>  <p>Keep them upside down.</p>	<p>3</p>  <p>Pour sufficient water to clean both the filters.</p>	 <p>You can keep the filters under a running tap water as well, while shaking the funnel continuously.</p>
--	--	--	---

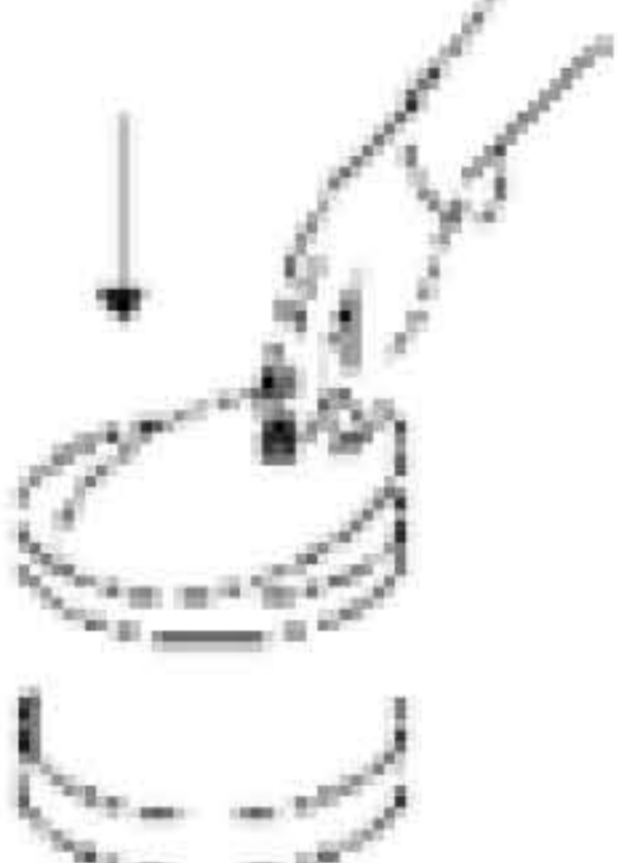

Frequency: Both Sediment & Carbon Filters must be cleaned once a week.

Part 4: Replacing the Sediment Filter

<p>1</p>  <p>Separate the filter housing from the Inlet Funnel by unscrewing it.</p>	<p>2</p>  <p>Remove the old Sediment Filter.</p>
<p>3</p>  <p>Fix the new Sediment Filter.</p>	<p>4</p>  <p>Fix the filter housing with the Inlet Funnel by screwing it accordingly.</p>

Frequency: The Sediment Filter should be changed after every 3 months.

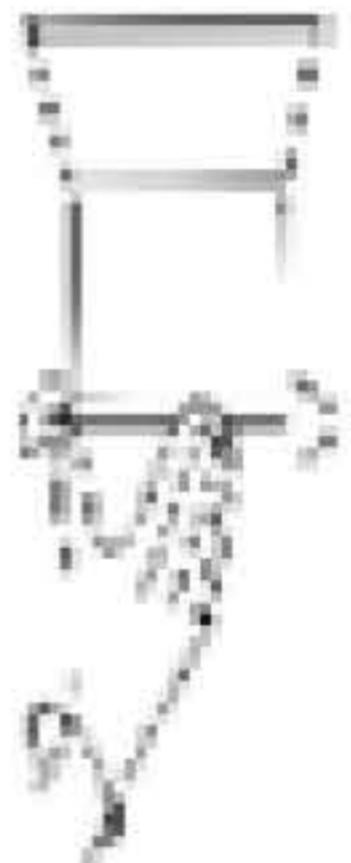
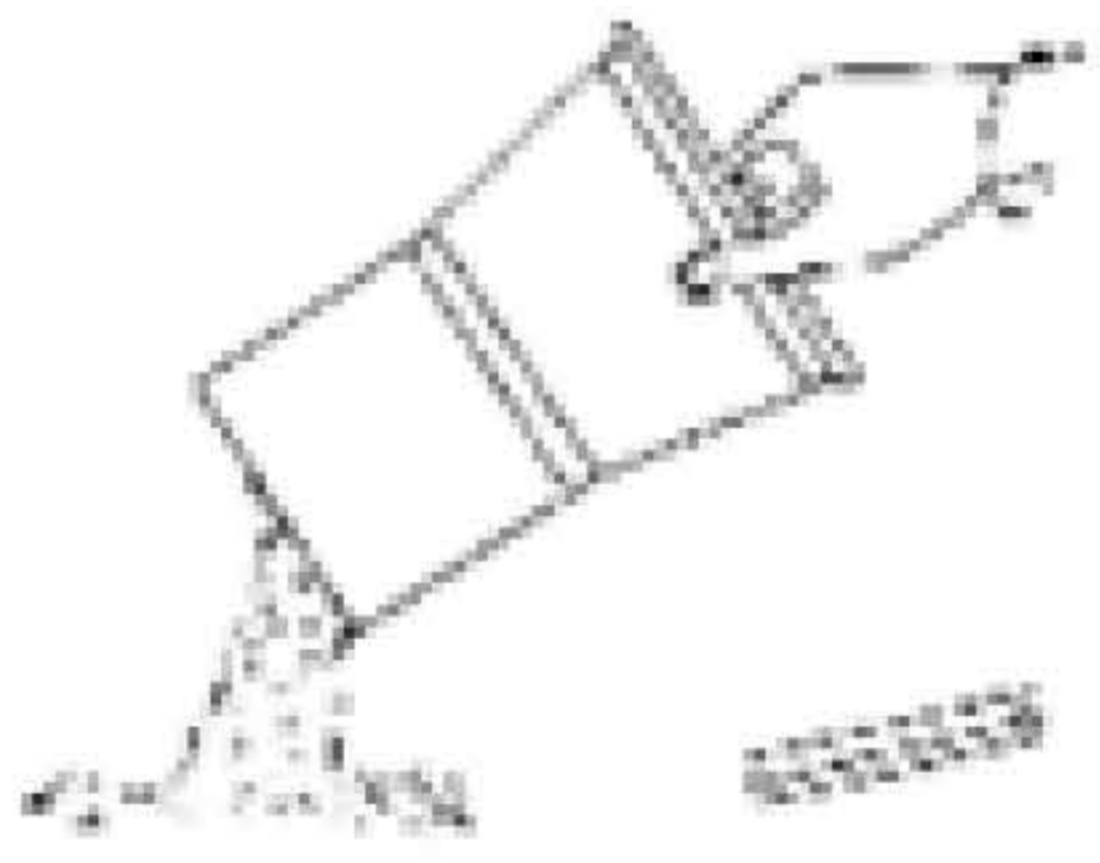
Part 5: Replacing the Carbon Filter

<p>1</p>  <p>Unscrew the bottom cap of the filter housing.</p>	<p>2</p>  <p>Empty the old Carbon granules on a sheet of paper.</p>
<p>3</p>  <p>Now, pour the new Carbon granules from a pack of genuine KENT consumables.</p>	<p>4</p>  <p>Tighten the bottom cap of the filter housing. Wash the new Carbon Filter (shake if required) under a running tap to remove carbon particles from the new carbon granules.</p>

Frequency: The Carbon Filter should be changed after every 6 months.

Part 6: Replacing the UF Membrane

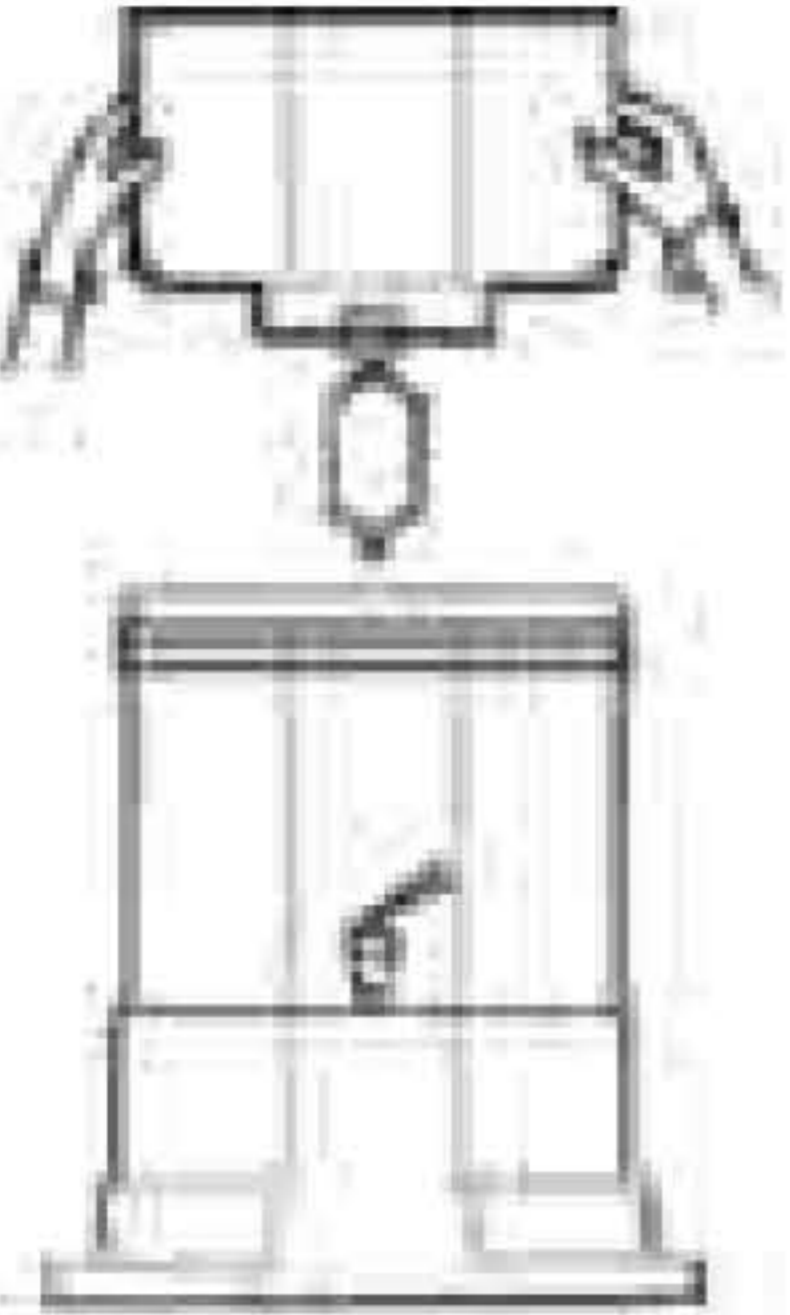
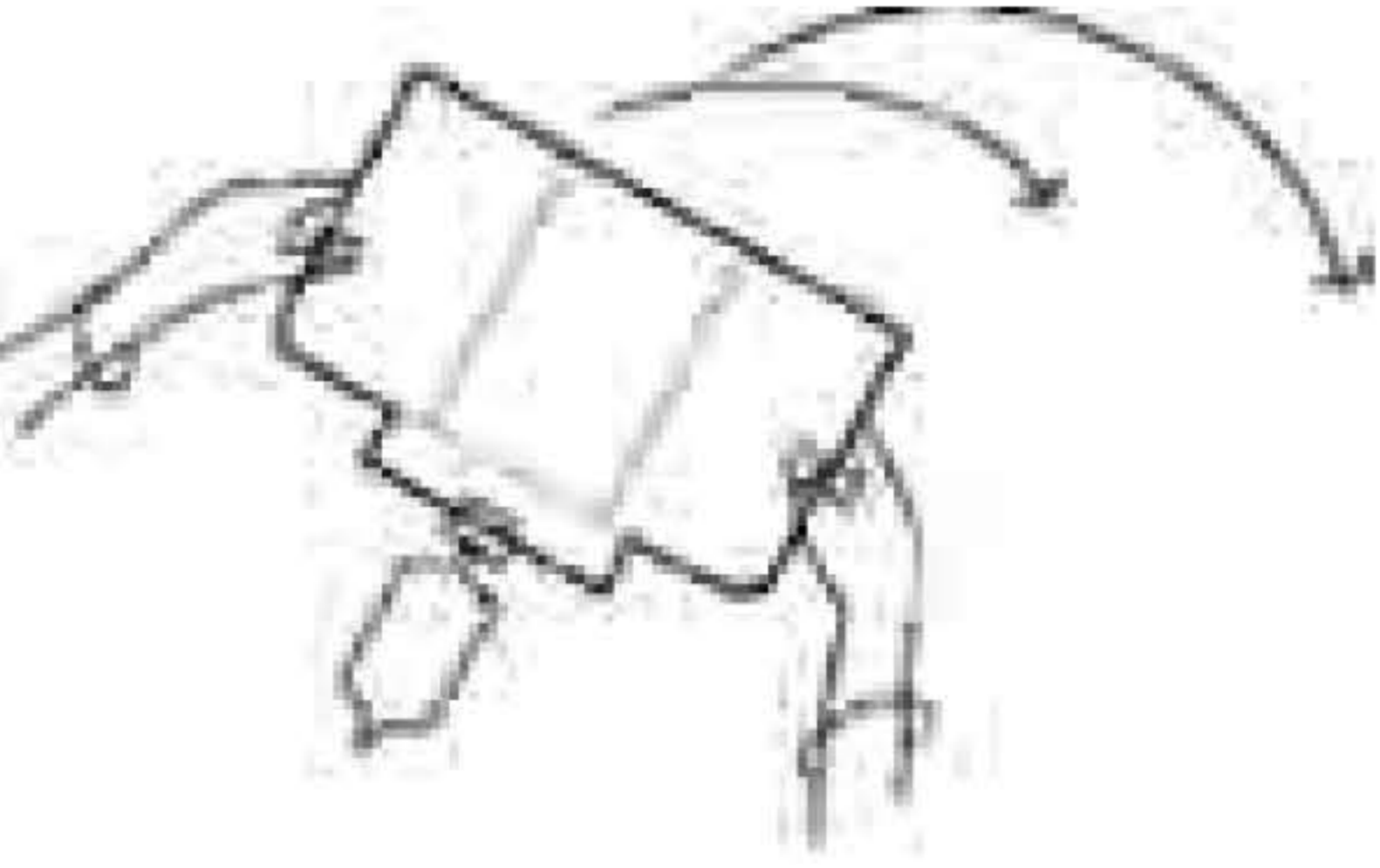
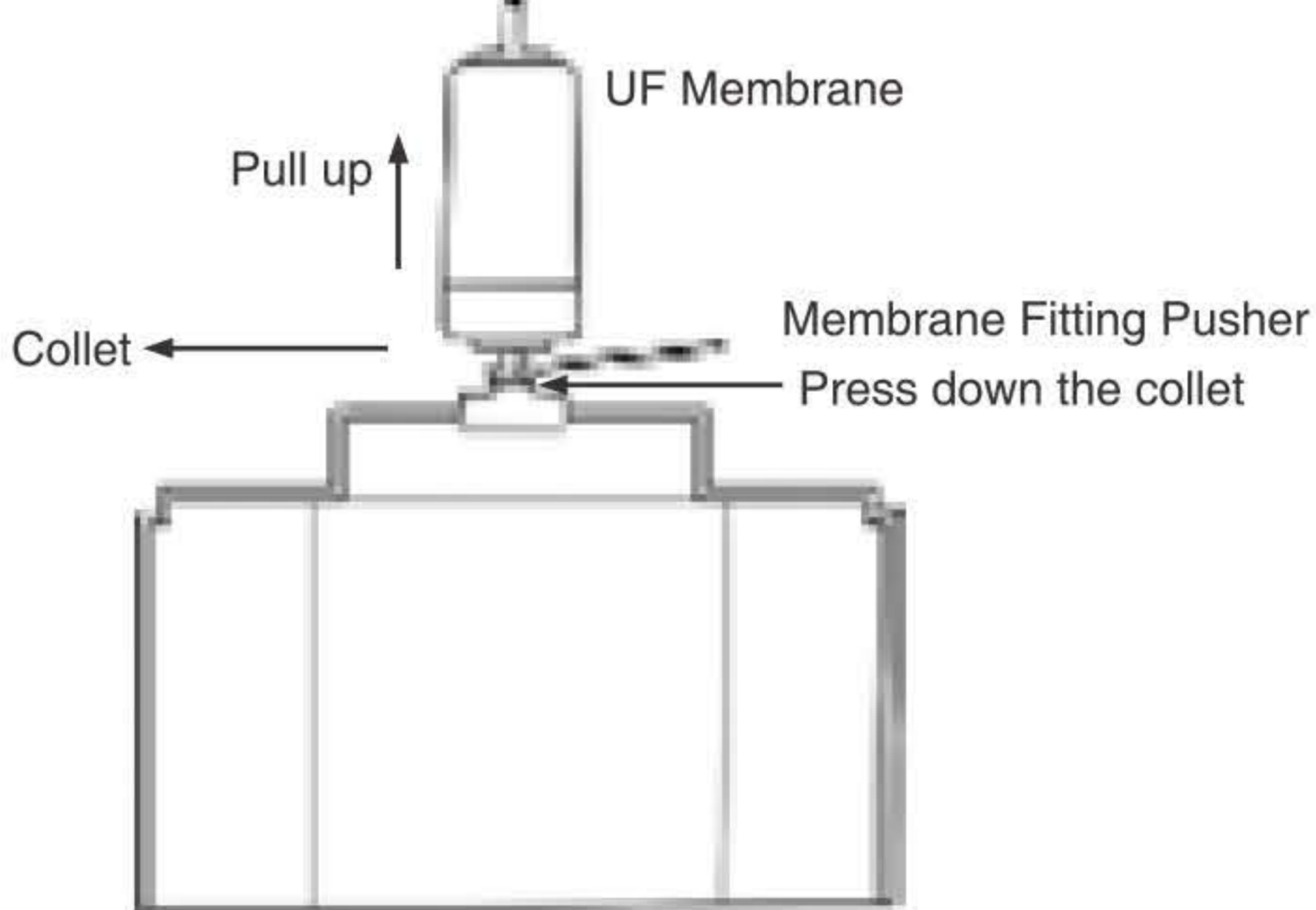
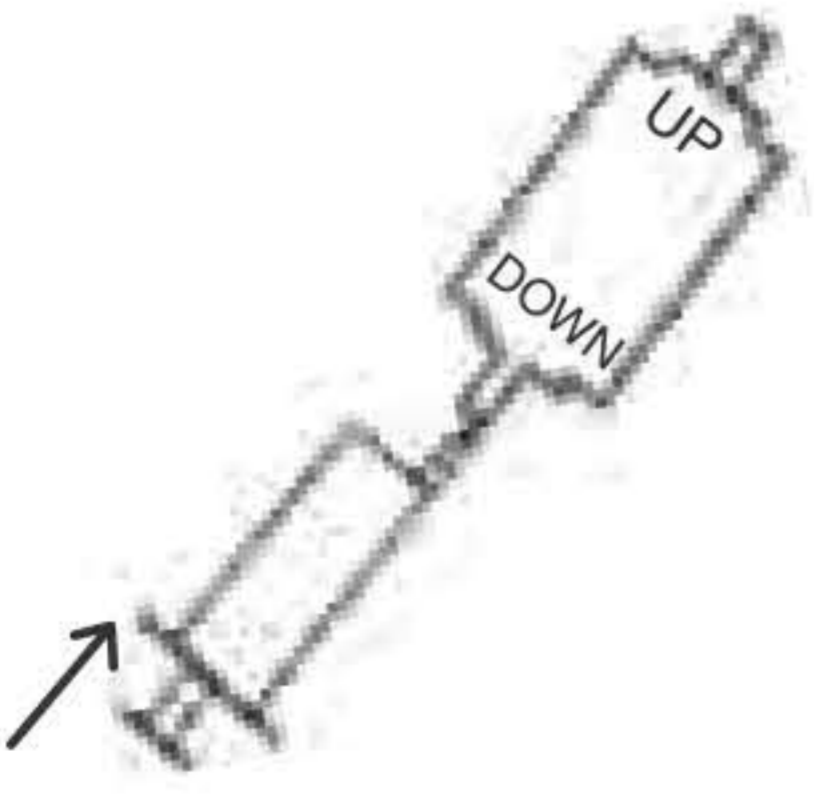
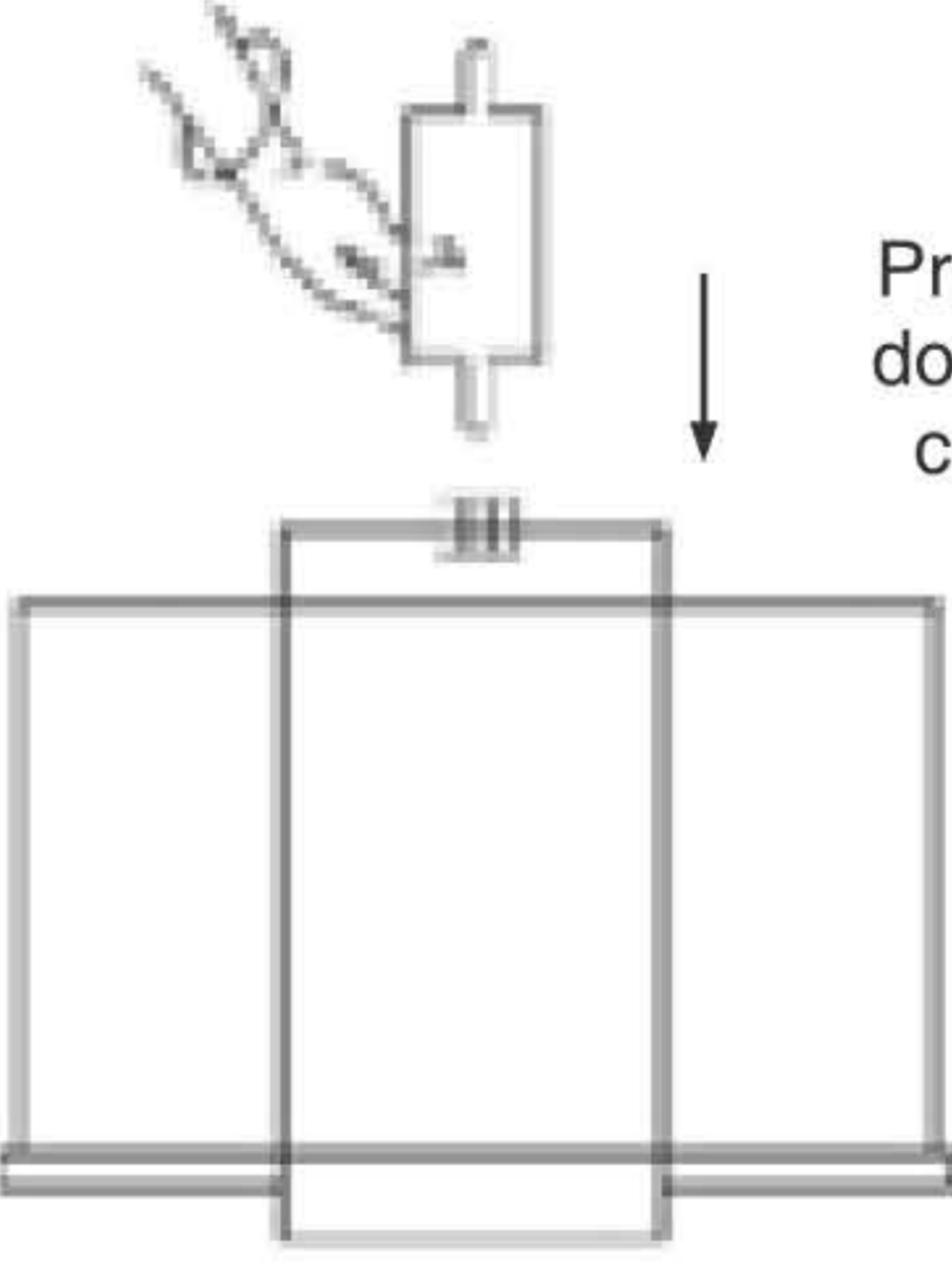
<p>1</p>  <p>Remove the top tank.</p>	<p>2</p>  <p>Place it upside down.</p>
<p>3</p>  <p>UF Membrane</p> <p>Pull up ↑</p> <p>Collet ←</p> <p>Membrane Fitting Pusher</p> <p>Press down the collet</p> <p>Press the collet down with the help of Membrane Fitting Pusher. While the collet is kept pressed down, pull up the membrane cartridge.</p>	
<p>4</p>  <p>Take 50 ml of pure water in the syringe and inject it inside the membrane cartridge (opposite to the direction of flow) to wet the new membrane.</p>	<p>5</p>  <p>Press it down in collet</p> <p>Fix new membrane cartridge in the Top Tank by pressing it downwards.</p>

Frequency: UF Membrane should be changed, every year.

Part 7: Restoring your KENT Gold (when leaving for long vacations)

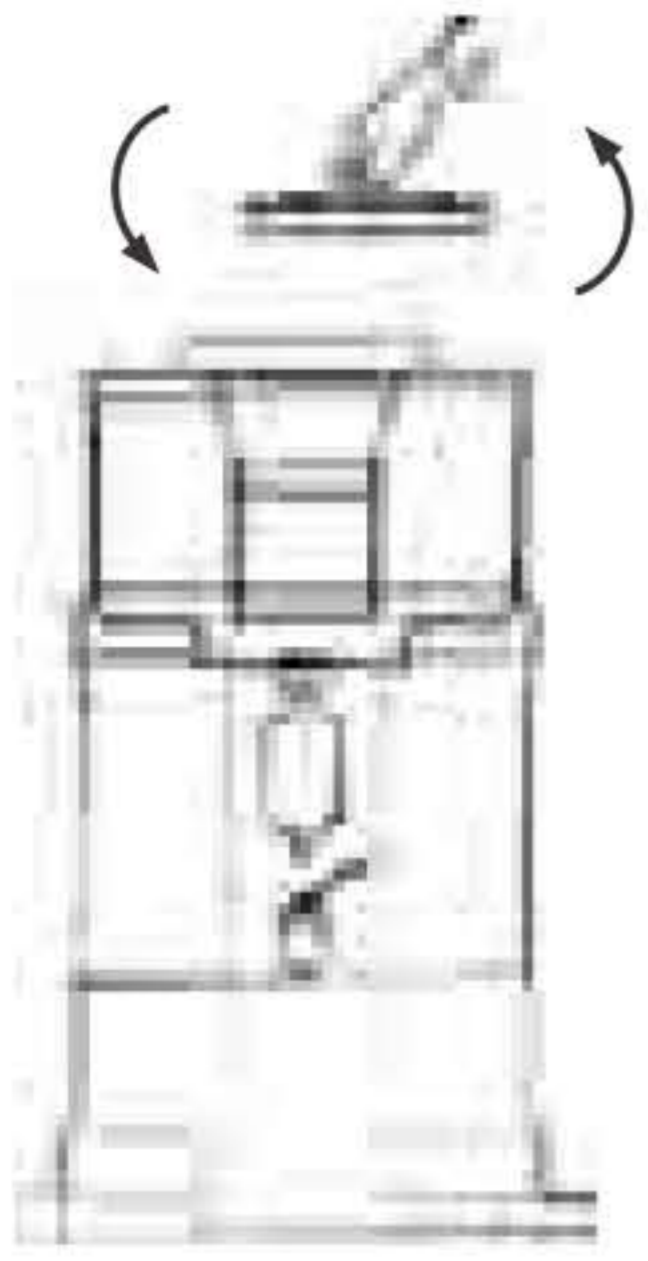
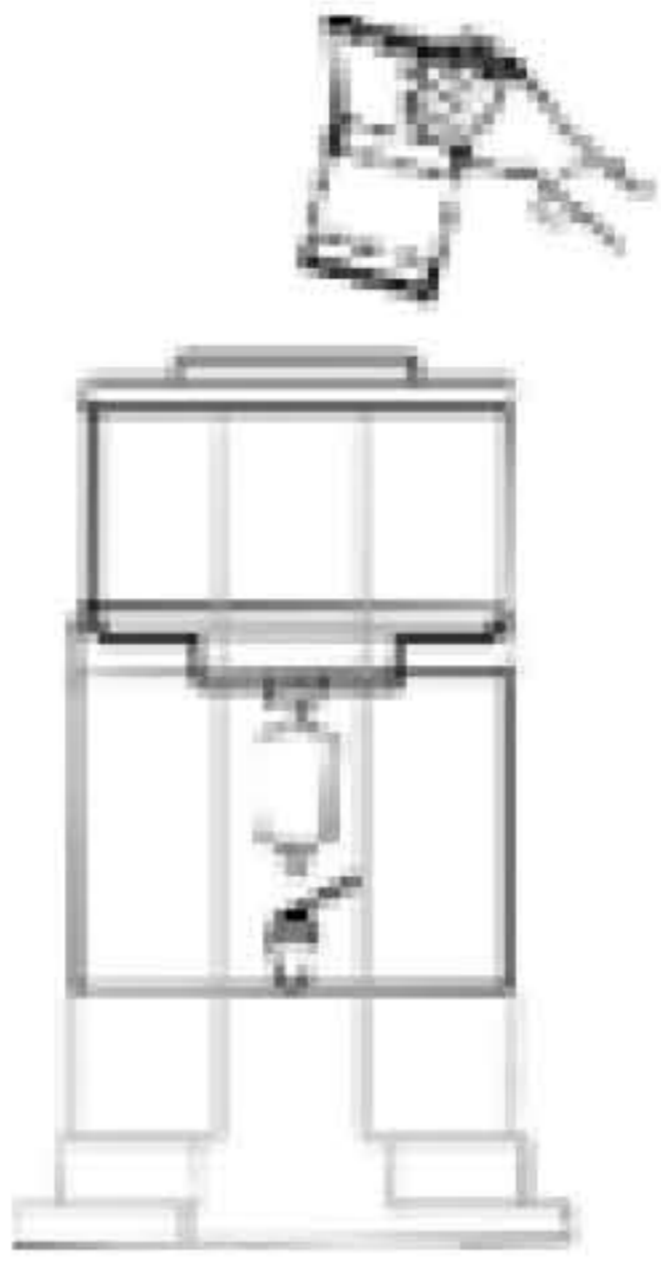
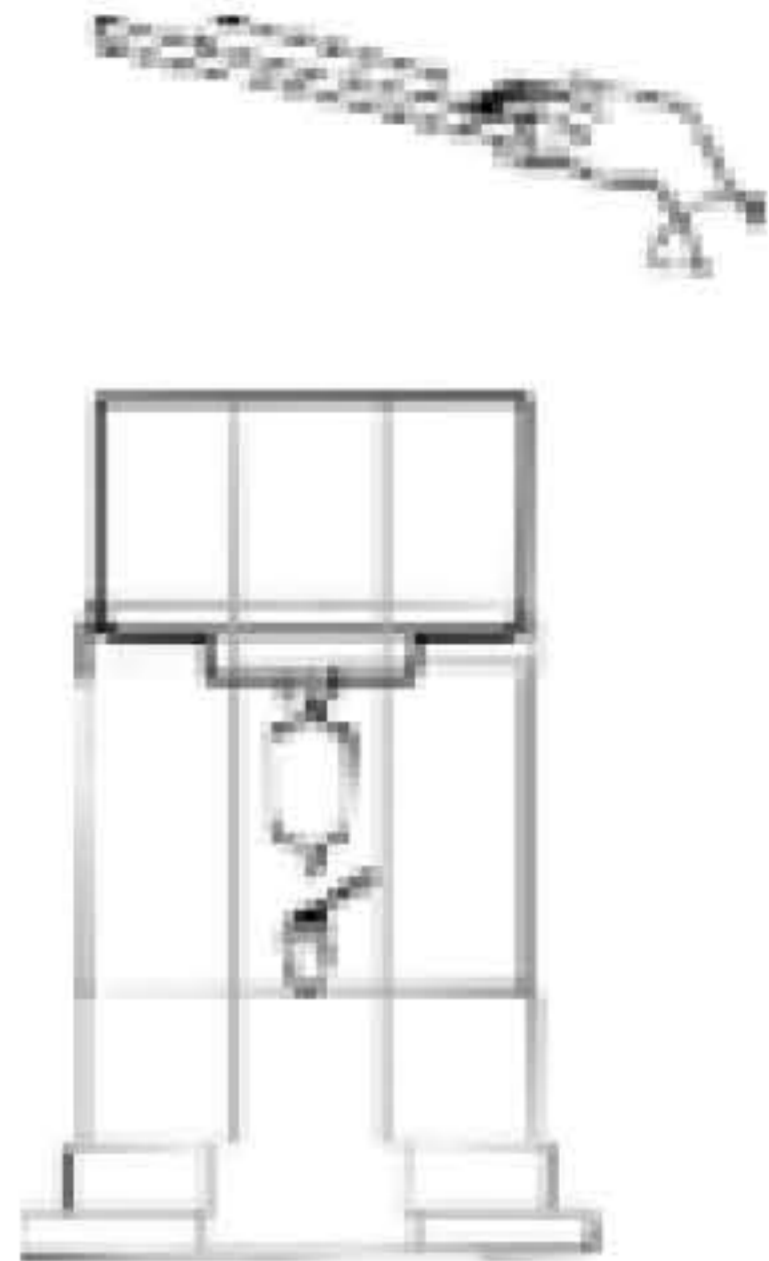
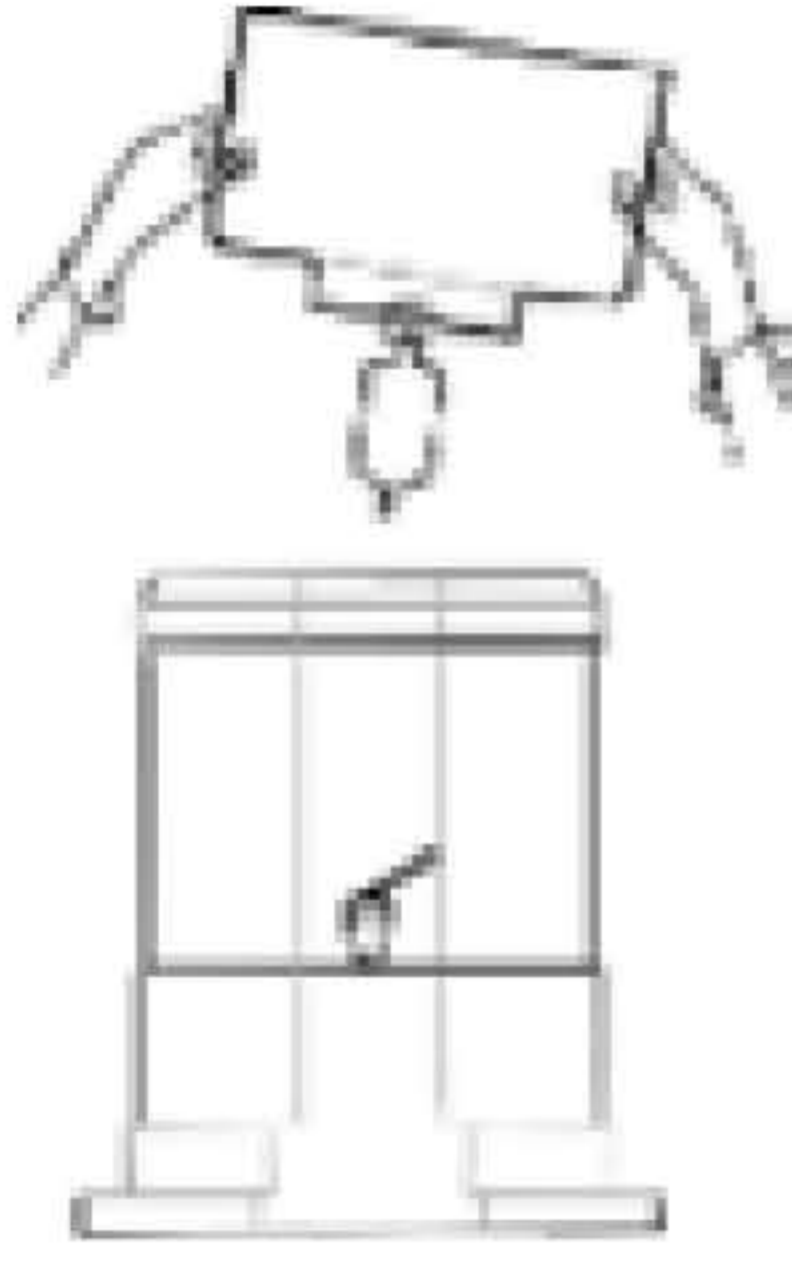
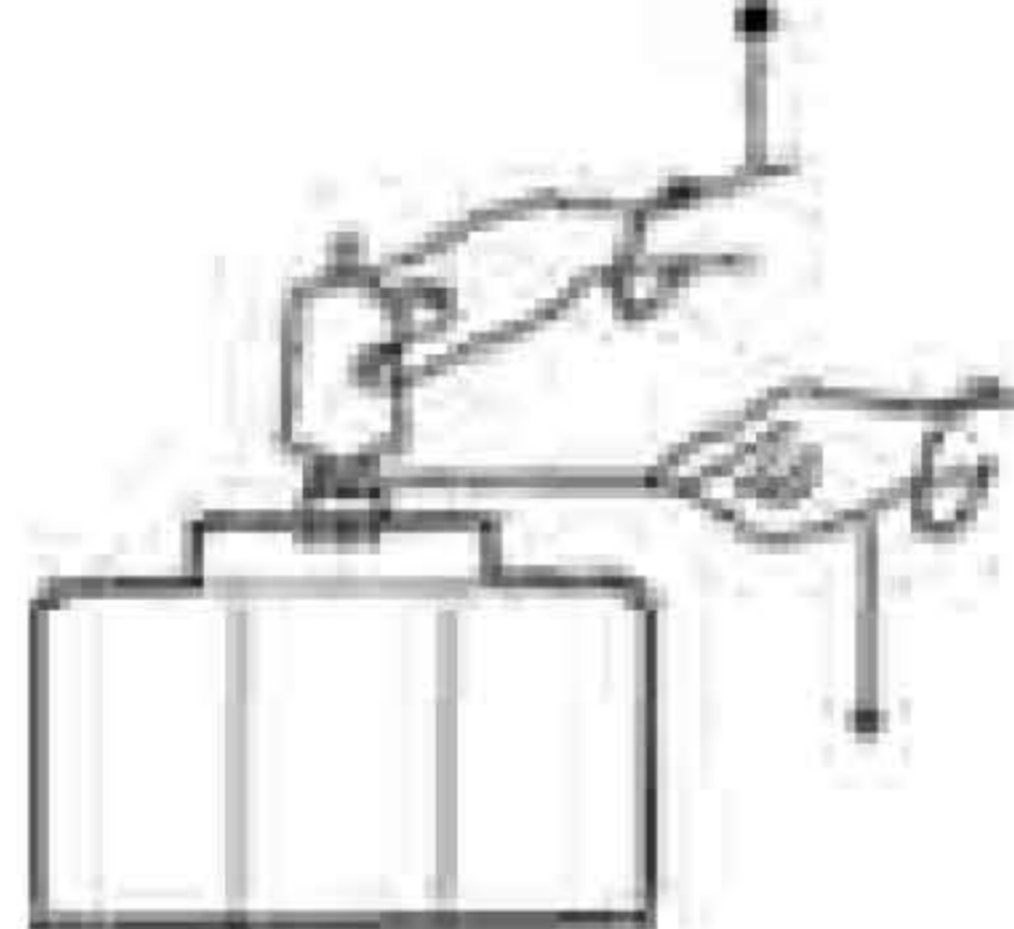
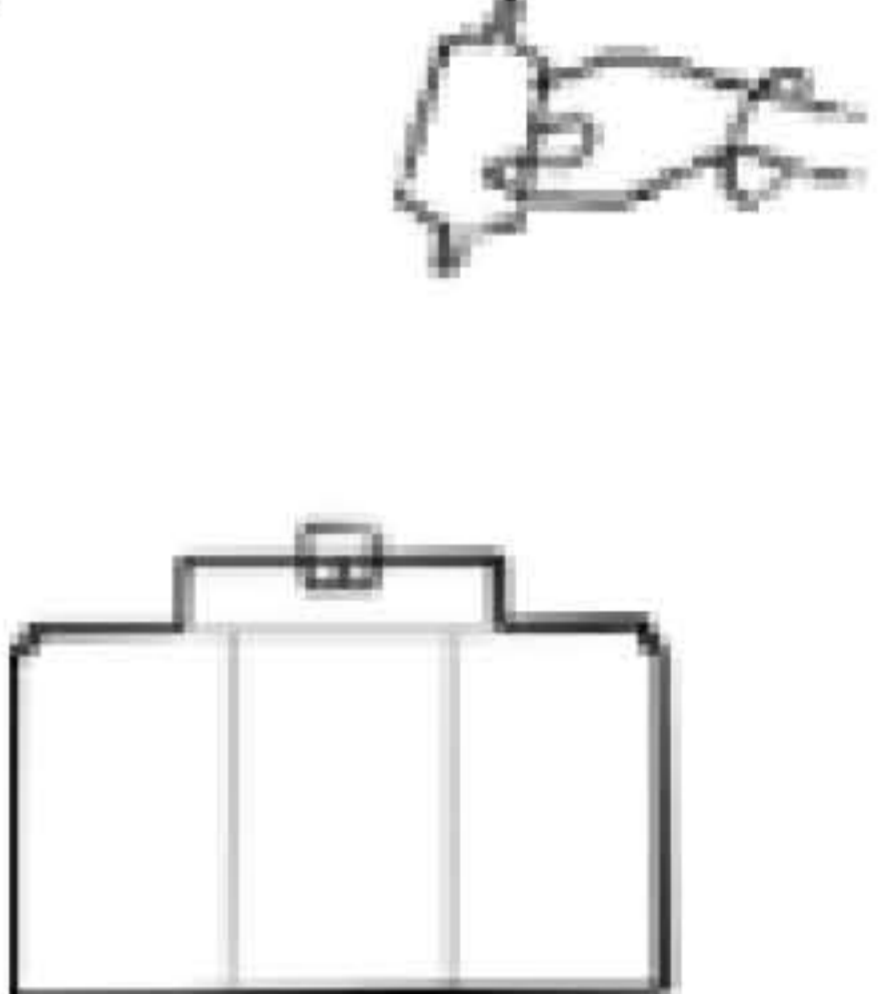
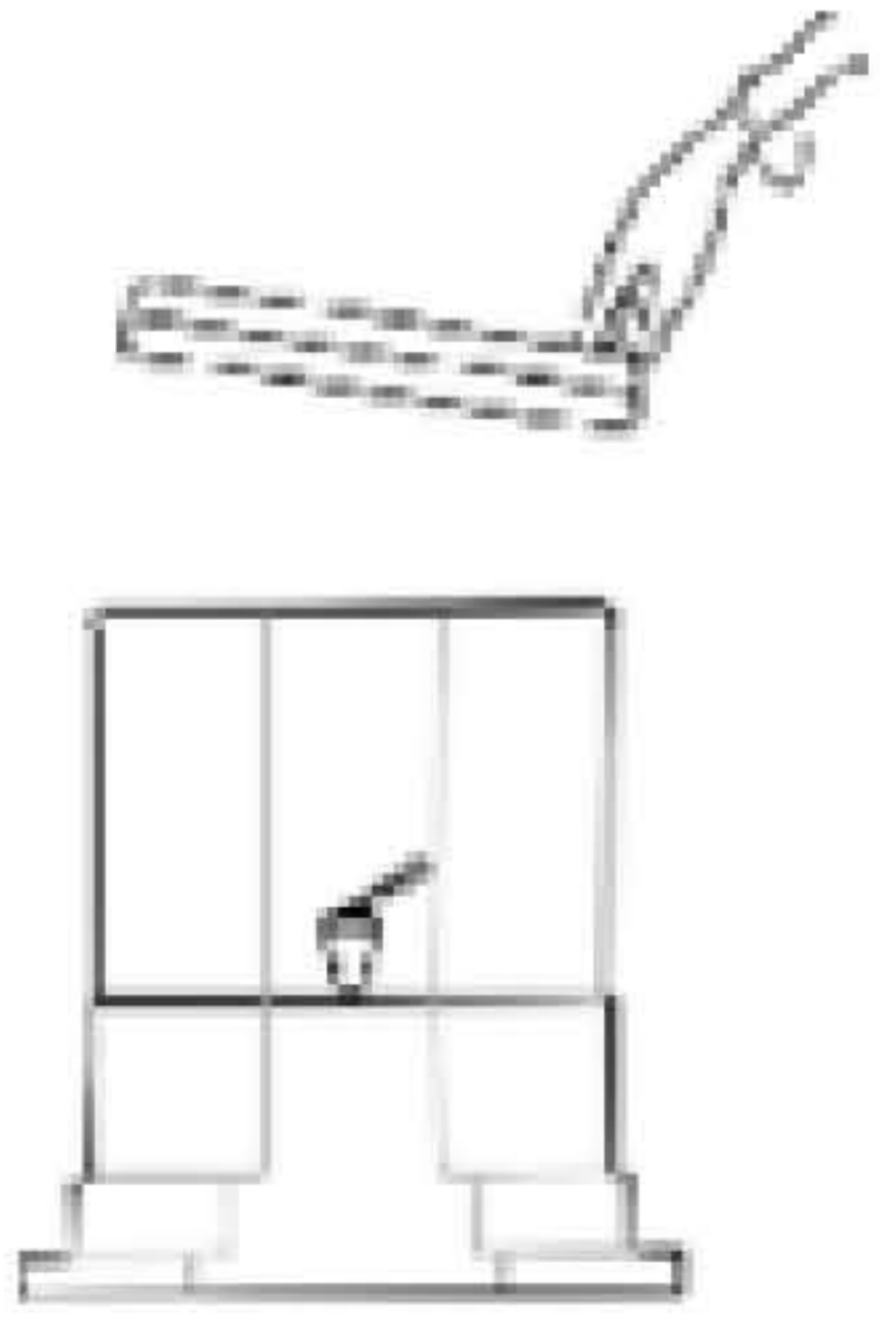
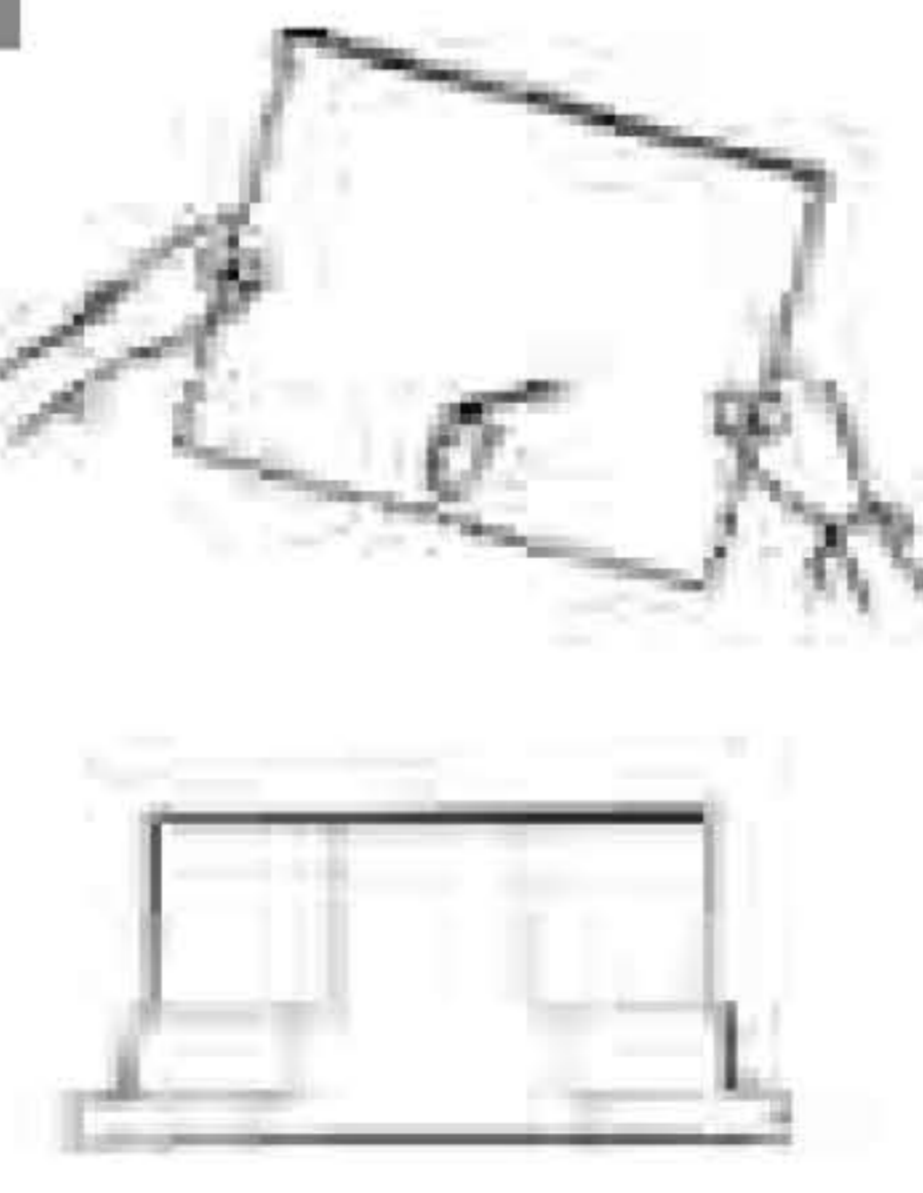
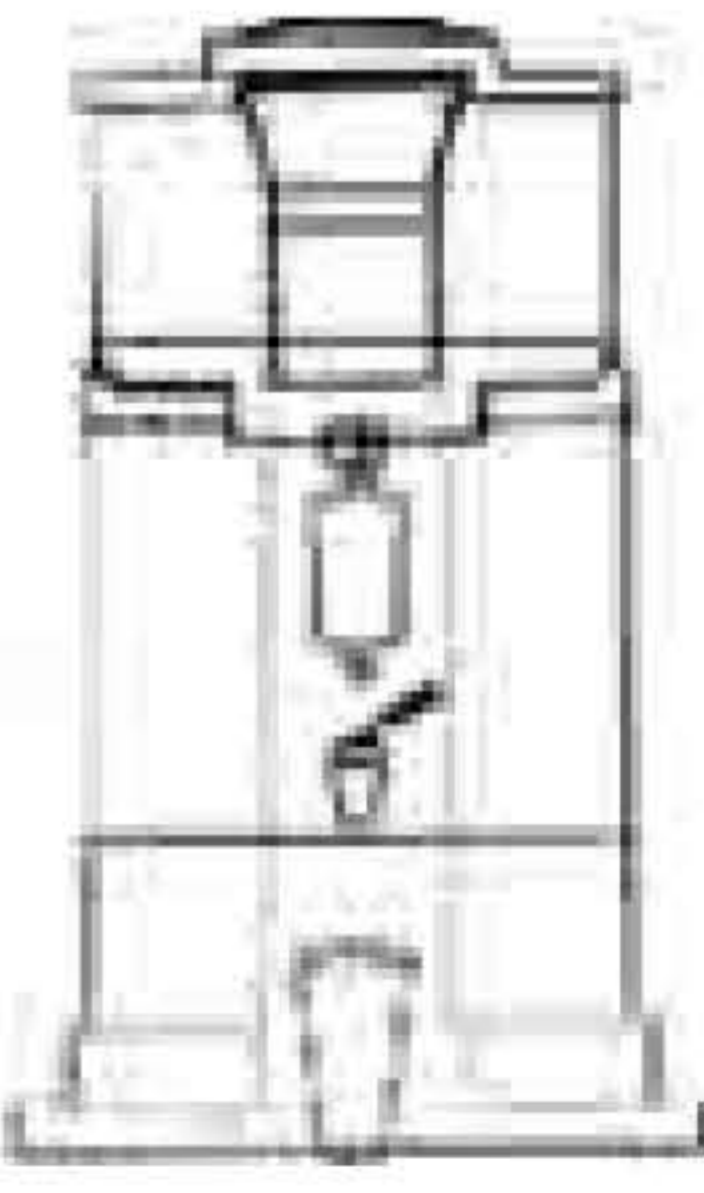
<p>1</p>  <p>Remove the top lid.</p>	<p>2</p>  <p>Remove the filter assembly.</p>	<p>3</p>  <p>Remove the Top Cover from the Top Tank.</p>
<p>4</p>  <p>Remove the top tank.</p>	<p>5</p>  <p>With the help of a Membrane Fitting Pusher press the collet and pull up the membrane cartridge.</p>	<p>6</p>  <p>Remove the membrane cartridge.</p>
<p>7</p>  <p>Remove the middle partition.</p>	<p>8</p>  <p>Separate the Bottom Tank from the Bottom Stand.</p>	<p>9</p>  <p>Clean all plastic parts from inside and outside with a clean cloth. Re-assemble the dry purifier.</p>

Frequency: Restore your purifier, whenever you are going on a vacation for more than 7 days.



System Tested and Certified
by NSF International against
NSF/ANSI Standard 53 for
the Reduction of Cyst



"System tested & certified
by WQA to WQA S-200 for the
reduction of Chlorine Taste and
Odor, and Cyst, as verified and
substantiated by test data."



HOUSE of PURITY



ISO 9001:2008
C e r t i f i e d



For customer complaints, contact customer care office at:

E-6, 7 & 8, Sector 59, Noida, UP 201 309, India
Call:09582-123456 or Fixed line: +91-120-4669666
E-mail: service@kent.co.in

Manufactured by:

KENT RO SYSTEMS LTD.

Khasra No. 93, Village-Bantakhedi, Tehsil-Roorkee,
District-Haridwar, Uttarakhand-247 668, India

Marketed by:

KENT RO SYSTEMS LTD.

E-6, 7 & 8, Sector 59, Noida, UP 201 309, India
Ph.: +91-120-3075075
E-mail: sales@kent.co.in Website: www.kent.co.in

