

SUVCON

3CH Dash Camrea

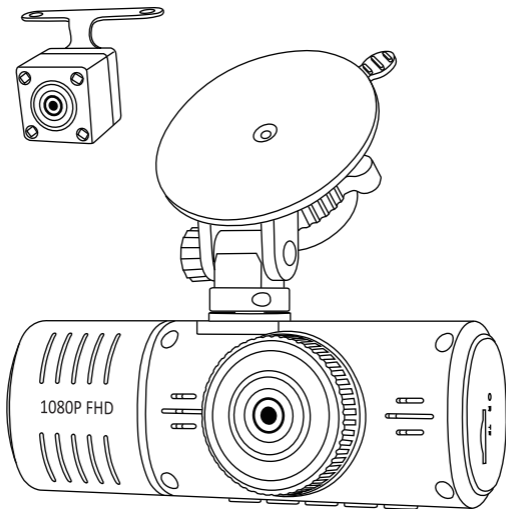

Please read the instructions carefully before use and keep them properly

Catalog

Warning-----	1
Common problems and solutions-----	2-3
Dash cam detail introduction-----	4
Button function-----	5
Set up and installation-----	6-15
Specification-----	16

WARNING

- Before removing the suction cup from the dash cam, remove the suction mount from the glass and horizontally push the bottom socket that connects the suction cup to the dash cam (the instructions show how to push the bottom of the socket); if not used correctly will damage the base! Do not remove the suction cup from the dash cam socket while it is still secured to the glass; This will be very easy to damage the suction cup.
- This product is intended for using in motor vehicles only. Do NOT install the camera where it might block the driver's view of road (including the mirrors) or the deployment of the airbag.
- Before using this device, please insert the memory card first, and need to format micro SD card to FAT32 format on PC firstly, then format the memory card in camera menu.
- This camera records video at high resolution. Be sure to use high speed Micro SD card (Class 10 or above).16 GB or 128GB Micro SD card is recommended. It is compatible with up to 128GB SD cards.
- For safety reasons, this camera has a small built-in battery, which is used to save the video file after external power supply cuts off (car turns off).
- Be sure the camera lens is clean and there is nothing blocking the lens.
- DO NOT leave the camera in direct sunlight for a long period of time or where the temperature could go above 140°F(60°C).
- Any silicone suction mount will shrink when exposed to heat, so please do not install the suction mount at more than 140°F/60°C to avoid the suction mount falling.
- Before installing the adjustable suction mount, tear off the protective film on the adjustable suction mount and clean the dust on the glass to prevent dust from sticking to the glass and air entering between the suction mount and the glass, causing the suction cups to fall.

Common Problems and Solutions:

Excellent after-sales service:

If you have any questions about our products or have problems during use, please send your questions to the email:

support@suvcon.store

Warranty: 1 year

We'll help you as soon as possible

Q: Why doesn't pressing the "Menu" button respond when recording?

A: When recording, you must pause the recording before entering the menu page; Press the pause "ok" button, then press the Menu button.

Q: Even though set the screen saver, but the screen will randomly.

A: The power supply might not be stable, please change another car charger to try.

Q: Why dash cam drain car battery?

A: Please check whether the cigarette lighter still be on after you turn off car engine.

Q: The camera keeps starting and off?

A: That could be the parking monitor function being triggered, check the setup menu.

Q: The dash cam will stop automatically while recording.

- A:**
1. Check whether the memory card is full.
 2. Check whether the Micro SD card is high-speed above C10.
 3. Check the memory card, there might be too many locked video that the loop recording won't work right.
 4. Check the car charger connection status, if the connection is loose, the power supply is not stable, the camera will automatically turn off.

Q: If the video played on the computer is somehow not fluent or jammed.

- A:**
1. Try to play the video with other video players, like : Potplayer or VLCplayer.
 2. Format your Micro SD card in the camera.
 3. Run speed test on the memory card to make sure the memory card fits the requirement: Write Speed is over 10MB/S.

Q: There are stripes interference in the image. There should be wrong light frequency.

- A:** According to the local main frequency, make the appropriate settings 50HZ or 60HZ.

Dash cam detail introduction

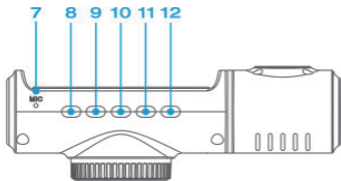
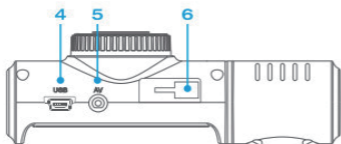
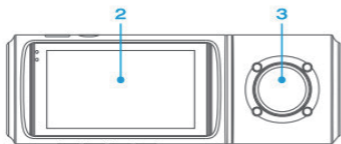
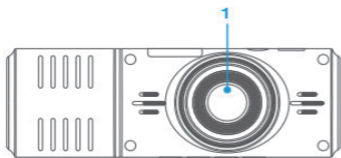

1. Front Lens
2. Screen
3. inside
4. Mini USB
Power in
5. Rear Cam
Interface
6. Mount Socket
7. MIC
8. Power
9. OK
10. UP
11. Menu
12. Down
13. Memory
Card Slot
14. Reset

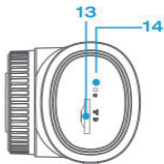

Button Function:

Power	Long press to turn ON / OFF the camera Short press the power button to darken/brighten the screen.
OK	In Standby / Video / Photo Mode. Short press to start / stop video recording or take a photo In Setting Menu, short press to confirm selection and adjustment. In Playback, short press to select and play recorded files,
UP	In Setting Menu. Short press to select option and adjust values In Playback,short press to select media files, long press to swith front and rear media files. During video recordings short press to switch front, rear and inside camera display.
Menu/ Mode	Please press Ok button to pause recording firstly, short press to access the menu settings, and then press once again to access System Setting Menu. In standby, Long press to switch mode between Video / Photo / Playback.
Down	In Setting Menu. Short press to select option and adjust values In Playback , short press to select media files, long press to swith front and rear media files. During video recording, short press to turn ON/OFF audio recording



Twist the regulator behind the suction cup, turn it to the left①, hear a "click" sound, loose, remove the suction cup from the glass;
Twist to the right② and hear a "click" sound, indicating that the suction cup has been fixed on the glass



①Screw "a" to remove the suction cup from the tachograph
②Push the bottom of the suction cup "b" to the left with your thumb to remove the suction cup from the dashcam

Set up and Installation:

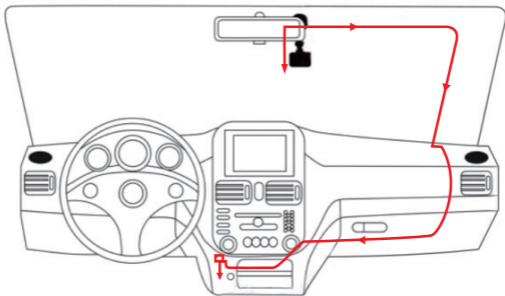

1. Before installation, please check the camera's normal function and make sure you are using a high speed Micro SD card, (speed Class 10 or above), and format the card in the camera menu before recording.
2. Use the suction cup mount to install the J06 dash cam on the windshield. The recommended place is near the rearview mirror facing front, adjust the lens angle for best coverage.
3. Adjust the lens angle of the camera, make sure you get the best coverage over the hood and the road ahead, so you can record what happens.
4. Connect the power to the camera and the cigarette lighter, hide the rest of the cable in the gap of the interior trim board.

Installing the rear camera

Position 1: For easy installation, install the rear camera on the rear windshield



Fig.1

Position 2: Rear camera should be installed near the license plate.

Position 2 is very advised. Both the rear viewing and reverse guidance images are sharp and clear To use the reversing function-please install the rear camera in this position



Fig.2

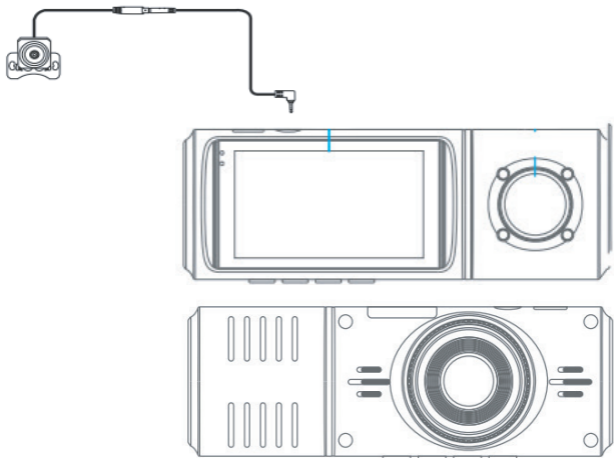

Operating Mode:

The J06 operates in 3 modes: Video Recording Mode, Photo Mode and Playback Mode. These modes also have menu to help you configure recording and taking photos. Press and hold "Menu" to switch between different modes and access to the mode you want. Watch the icon on top left corner of the screen for each mode.

Video Recording Mode:

The camera will automatically enter Video Recording Mode and start recording when connected to a car charger and power on. A Red dot flashing on the top left corner indicates recording is in progress. Press the OK to stop recording, or start recording again.

In all 3 operating mode, you can press the Menu button once to access the menu settings for that particular mode, and press twice to display System Setting Menu.

The System Setting Menu is common to all modes, See page 11 to page 12.

Press UP and DOWN to scroll through the various setting options and press OK to select and confirm selection, Press MENU again to exit the setting menu.

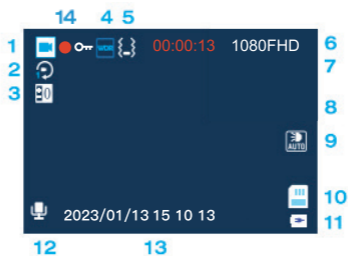

1. Video Mode Icon
2. Loop Recording
3. Exposure
4. HDR
5. G-Sensor
6. Recording Time
7. Resolution

8. Parking Monitor
9. LED Status
10. Memory Card Status
11. Power Status
12. Audio Status
13. Time & Date
14. Video mode

In all 3 operating mode, you can press the Menu button once to access the menu settings for that particular mode, and press twice to display System Setting Menu.

The System Setting Menu is common to all modes, See page 13 to page 14.

Press UP and DOWN to scroll through the various setting options and press OK to select and confirm selection, Press MENU again to exit the setting menu.

Video Recording Menu:



Resolution: Adjust front lens recording video resolution
3CH:1080P+720P+480P
720P+480P+480P

Loop Recording: This function allows you to set video length to Off/1/3 minutes, Select a value to activate loop recording, so when storage is full, it will automatically loop back to the earliest file and record over it.

High Dynamic Range: Turn on to optimize video quality with wider light range and image details.

Exposure: Adjust exposure value to adjust the brightness of the video.

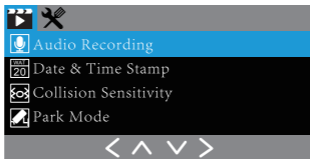

Audio Recording: Turn ON/OFF audio recording in video.

Date & Time Stamp: Enable/Disable the date and time marks in video files.

Collision Sensitivity: G-sensor will detect significant or sudden shock and movement, then automatically locks current file from loop recording. Low/medium/High sensitivity are available.

Park Mode: It's used to protect your car after parking. With this function on, after you stop the car and the camera turns off, it stays standby. When camera detects shock and collision, it will automatically turn on and take a short video, then shut down automatically.

(Because the parking mode function requires more power than can be supported by the internal battery in the dash cam, it is recommended to buy an additional drawdown cable for power)

Photo Taking Mode:

The J06 camera can operate in Photo Taking Mode, and take HD photo up to 10 Mega pixels.

To take a photo:

Simply power on the J06 camera. Long press MENU to select Photo Mode, and Press Ok to take photo.

Like the Video Recording Mode, you can press the Menu button once to access the setting menu for Photo Mode, Press Menu twice to enter system setting menu.

Photo Mode Menu:

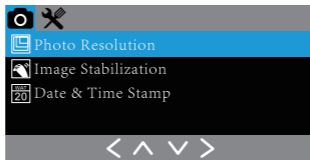

Photo Resolution: Set the photo resolution, Up to 10 Mega Pixels available.

Image Stabilization: Turn ON/OFF image stabilization function
Date & Time Stamp: Enable/Disable the date and time marks in image files.

Playback Mode:

This mode allows you to play back recorded video or view photos.

1. Stop video recording, long press MENU button twice to enter playback mode.

2. Use UP and DOWN button to scroll through the recorded files/photos, and press OK to view recorded video.

Playback Menu:

After choosing a recorded video or photo, press the Menu button once to access the setting menu for Playback Mode.

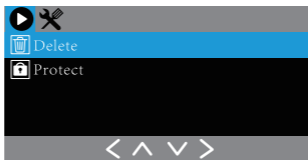

Delete: Delete the current file displayed or delete all files.

Protect: Lock/Unlock the current file displayed or Lock/Unlock all files.

System Setting Menu:

Press MENU button twice to access System Setting Menu in any mode. The TOOL icon is highlighted in the upper left corner.

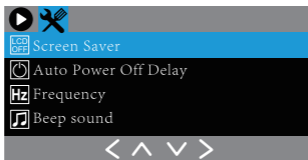

Screen Saver: Set the time to automatically turn off the LCD display after no operation.

Auto Power Off Delay: Set the time for the camera to automatically power off to save power. The camera will automatically power off when it is standby under the setting time.

Frequency: Set light frequency to 50Hz or 60Hz according to local regulation.

Beep Sound: Turn on/off sound when you press any button.

Language: English / German / Chinese /Japanese available.

Date & Time Stamp: Set the time and date. Press the Up and Down keys to adjust the numbers, then press the [OK] button to confirm/change, and press the [M] button again to exit the time setting.

Format Memory Card: Format the Inserted Micro SD card.

Reset to Default: Restore default

Firmware Version: N3D4C-J06-20230822

IR Night Vision: Turn on or off the 4 IR LED lights next to the inside camera.

Specification :

Model	J06
Image Sensor	High Resolution CMOS Sensor
Screen	2.45 inch LCD Display
Lens	170° High-Resolution Wide Angle Lens
Video Resolution	1080P+720P+480P/ 720P+480P+480P
Video Format	MOV
Video Coding	H.264
Picture Format	JPG
Photo Resolution	12MP / 10MP / 8MP / 5MP /3MP/2MP/ 1.3MP/VGA
Loop Recording	Supported
Power on recording	Supported
HDR	Supported
G-Sensor Lock	Supported
Language	Chinese/English/Japanese/Deutsh/ French/Italian/Spanish
Audio Recording	Built-in microphone, On / Off optional
Storage	Micro SD Card (up to 128GB)
USB interface	Mini USB
Operating System	Windows 7/10 or MAC
Internal Power	Built-in Li-ion Battery
External power supply	DC 5V / 1.5A
Storage temperature	-4°F~140°F (-20°C~60°C)
Operating temperature	14°F~122°F (-10°C~50°C)