

## TURBOCLEAN DUALPRO PET MODELS 3067, 3072

Warranty .....	2
What's in the Box?.....	3
Assembly .....	3
Cleaning Formulas.....	4
Filling the Clean Water Tank .....	5
Cleaning Carpets and Area Rugs .....	6
Cleaning with the Hose and Tool.....	7
Emptying the Dirty Water Tank.....	8
After-Cleaning Care.....	8
Replacing the Belts and Brush Rolls.....	10
Troubleshooting .....	11

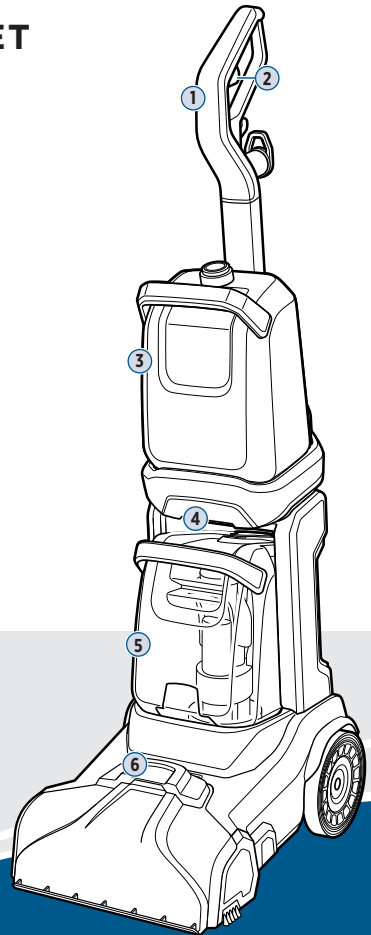

### Product Overview

1. Upper Handle
2. Spray Trigger
3. Clean Water Tank
4. Carry Handle
5. Dirty Water Tank
6. Accessory Hose Door



### Go online for a comprehensive walkthrough of your new purchase!

This guide has everything you need to get ready for first use, including setting up, using and maintaining your machine, but online you'll find additional resources like tips and troubleshooting, videos, product registration, parts, and more. Go to [support.BISSELL.com](http://support.BISSELL.com).

# IMPORTANT SAFETY INSTRUCTIONS



## READ ALL INSTRUCTIONS BEFORE USING YOUR APPLIANCE.

When using an electrical appliance, basic precautions should be observed, including the following:



## WARNING

### TO REDUCE THE RISK OF FIRE, ELECTRIC SHOCK OR INJURY:

- » Connect to a properly grounded outlet only. See grounding instructions. Do not modify the 3-prong grounded plug.
- » Do not leave appliance when it is plugged in. Unplug from outlet when not in use and before servicing.
- » Do not expose to rain. Store indoors.
- » Do not allow to be used as a toy. Close attention is necessary when used by or near children.
- » Do not use for any purpose other than described in this user guide. Use only manufacturer's recommended attachments.
- » Do not use with damaged cord or plug. If appliance is not working as it should, or has been dropped, damaged, left outdoors, or dropped into water, have it repaired at an authorized service center.
- » Do not pull or carry by cord, use cord as a handle, close a door on cord, or pull cord around sharp edges or corners.
- » Do not run appliance over cord. Keep cord away from heated surfaces.
- » Do not unplug by pulling on cord. To unplug, grasp the plug, not the cord.
- » Do not handle plug or appliance with wet hands.
- » Do not put any object into openings. Do not use with any opening blocked; keep openings free of dust, lint, hair, and anything that may reduce air flow.
- » Keep hair, loose clothing, fingers, and all parts of body away from openings and moving parts of the appliance and its accessories.
- » Turn OFF all controls before plugging or unplugging appliance.
- » Use extra care when cleaning on stairs.
- » Do not use to pick up flammable or combustible materials (lighter fluid, gasoline, kerosene, etc.) or use in areas where they may be present.
- » Do not use appliance in an enclosed space filled with vapors given off by oil-based paint, paint thinner, some moth-proofing substances, flammable dust, or other explosive or toxic vapors.
- » Do not use to pick up toxic material (chlorine bleach, ammonia, drain cleaner, etc.).
- » Do not pick up anything that is burning or smoking, such as cigarettes, matches or hot ashes.
- » Do not pick up hard or sharp objects such as glass, nails, screws, coins, etc.
- » Do not use without filters in place.
- » Use only BISSELL® cleaning formulas intended for use with this appliance to prevent internal component damage. See the "Cleaning Formulas" section of this guide.
- » Do not immerse. Use only on surfaces moistened by the cleaning process.
- » Keep appliance on a level surface.
- » Do not carry the appliance while in use.
- » Always install float before any wet pick-up operation.
- » Unplug before connecting TurboBrush® Tool.
- » Plastic film can be dangerous. To avoid danger of suffocation, keep away from children.
- » Liquid must not be directed towards equipment containing electrical components.
- » Use only the type and amount of liquids specified under the operations section of this guide.

## SAVE THESE INSTRUCTIONS

THIS MODEL IS FOR HOUSEHOLD USE ONLY.

COMMERCIAL USE OF THIS APPLIANCE VOIDS THE MANUFACTURER'S WARRANTY.

## ⚠️ WARNING

Improper connection of the equipment-grounding conductor can result in a risk of electrical shock. Check with a qualified electrician or service person if you aren't sure if the outlet is properly grounded. **DO NOT MODIFY THE PLUG.** If it will not fit the outlet, have a proper outlet installed by a qualified electrician. This appliance is designed for use on a nominal 120-volt circuit, and has a grounding attachment plug that looks like the plug in the illustration. Make certain that the appliance is connected to an outlet having the same configuration as the plug. No plug adapter should be used with this appliance.

### GROUNDING INSTRUCTIONS

This appliance must be connected to a grounded wiring system. If it should malfunction or break down, grounding provides a safe path of least resistance for electrical current, reducing the risk of electrical shock. The cord for this appliance has an equipment-grounding conductor and a grounding plug. It must only be plugged into an outlet that is properly installed and grounded in accordance with all local codes and ordinances.

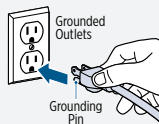

## IMPORTANT INFORMATION

If your appliance has a motorized Brush Roll, do not leave machine running in the same spot without the handle fully upright.

## Warranty

↖ 2-Year limited warranty, may vary by state. Visit [support.BISSELL.com](http://support.BISSELL.com) or call 1-800-237-7691 for complete warranty information.

## What's in the Box?

Standard accessories may vary by model. To identify what should be included with your purchase, please refer to the "Carton Contents" list located on the carton top flap.

			
Upper Handle	Base with Dirty Water Tank	Clean Water Tank	(2) BISSELL® Trial-Size Formulas
			
Accessory Bag and Hose	3" Tough Stain Tool	Nozzle Clean Out Tool	

## Assembly

▶ Go to [support.BISSELL.com](https://support.BISSELL.com) for assembly videos.

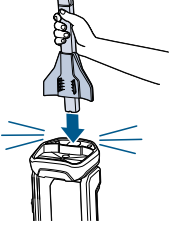
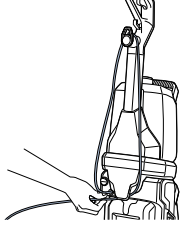
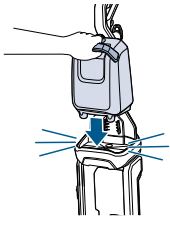
		
<b>1.</b> Insert the Upper Handle at the top of the base until you hear a "click".	<b>2.</b> Wrap cord around lower cord wrap and release hook.	<b>3.</b> At the bottom of the Upper Handle, align the Clean Water Tank with the grooves and slide the tank into place.

# Cleaning Formulas

View our family of cleaning formulas for your family of mess-makers at [BISSELL.com](http://BISSELL.com).

Keep plenty of BISSELL® formulas on hand so you can clean whenever it fits your schedule. Always use genuine BISSELL formulas in your machine. Other formulas may harm the machine and void the warranty.

				
<p><b>Clean + Refresh</b> Powerful cleaning and odor elimination with Febreze freshness.</p>	<p><b>PET Stain &amp; Odor</b> Removes tough pet stains. <i>Includes StainProtect™ to protect against future stains</i></p>	<p><b>PRO MAX Clean + Protect</b> Our most powerful formula for tough, ground-in dirt &amp; stains. <i>Includes StainProtect to protect against future stains</i></p>	<p><b>PET PRO OXY Urine Eliminator</b> Our best formula for pet urine stains &amp; odors. <i>Includes StainProtect to protect against future stains</i></p>	<p><b>Pet Stain &amp; Odor + Antibacterial</b> Cleans and controls odor-causing bacteria. <i>Use with easy fill® SYSTEM™</i></p>

Certain trademarks used under license from The Procter & Gamble Company or its affiliates.

## Pretreat

Pretreat spots and stains to improve carpet cleaning performance.

		
<p><b>PET Stain Pretreat</b> Permanently removes tough pet stains. Removes odors with Enzyme Action.</p>	<p><b>PET PRO OXY Stain Destroyer</b> Permanently removes tough pet stains. Removes pet odors with OXY.</p>	<p><b>PET Pretreat + Sanitize</b> Penetrates to sanitize and loosen tough stains.</p>

## Boost

Add Boost carpet cleaning formula enhancers to any formula to increase its effectiveness.

		
<p><b>OXY Boost</b> Permanently removes old, set-in stains.</p>	<p><b>PRO MAX Boost</b> Add to formula for 2X deep cleaning power.</p>	<p><b>PET OXY Boost</b> Permanently removes pet stains. Removes pet odors.</p>

**⚠️ WARNING** To reduce the risk of fire and electric shock due to internal component damage, use only BISSELL cleaning formula intended for use with this machine.

# Filling the Clean Water Tank

▶ More of a video person? Head to [support.BISSELL.com](https://support.BISSELL.com) for helpful how-to videos.

**Note:** Fill with warm (140°F/60°C MAX) tap water and add the appropriate BISSELL® formula. Do not use boiling water. Do not heat water or tank in microwave.



**1.** The Clean Water Tank is on the top of the machine.

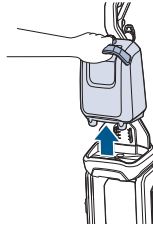

**2.** Lift the Clean Water Tank straight up to remove from the machine.



**3.** Unscrew the yellow cap from the Clean Water Tank.

**4.** Fill the Clean Water Tank with water and formula.



## Cleaning Formula

Fill with hot tap water to the Water Fill Line above Carpet Cleaning. Add formula to the Formula Fill Line above Carpet Cleaning. If you're using a Boost formula additive, add two ounces to your tank.



## Trial-Size Antibacterial Formula

Fill with hot tap water to the Water Fill Line below the Easy Fill line. Add Antibacterial formula to the **easy fill** line.

**NOTICE:** BISSELL Antibacterial formula is only for BISSELL machines with Easy Fill System.



## For Future Use with Full-Size Antibacterial Formula with Easy Fill System

Fill with hot tap water to the Water Fill Line below the Easy Fill line. Twist the yellow cap back onto the tank. Firmly insert the formula bottle into the cap on the tank and squeeze until formula reaches the **easy fill** line and skip to step 6.

**NOTICE:** BISSELL Antibacterial formula is only for BISSELL machines with Easy Fill System.



**5.** Screw the cap back onto the Clean Water Tank.

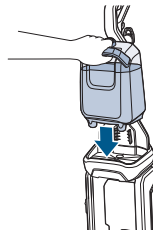

**6.** Align tank with grooves on the machine. Slide tank down into place.

# Cleaning Carpets and Area Rugs

Visit [support.BISSELL.com](http://support.BISSELL.com) for helpful how-to carpet cleaning videos.

## Tips Before Cleaning

- Use a dry vacuum cleaner over area before using your deep cleaner.
- To prevent damage to Berber carpets, avoid repeated strokes in the same area.
- Before cleaning area rugs, check the manufacturer's tag and test an inconspicuous spot on the rug for colorfastness. Don't use on silk or delicate rugs.
- It is common to refill the Clean Water Tank and empty the Dirty Water Tank multiple times during cleaning. Room size and cleaning speed both affect how often the tank may need to be refilled and/or emptied.

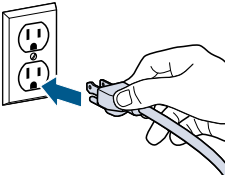
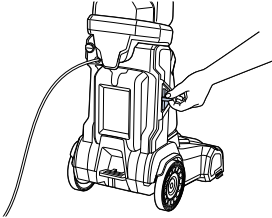
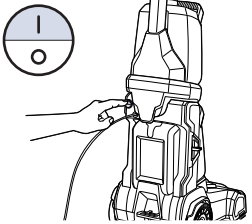
		
<p><b>1.</b> Plug into a properly grounded outlet.</p>	<p><b>2.</b> Select cleaning mode based on the below chart.</p>	<p><b>3.</b> Press the power button to turn the machine ON.</p>

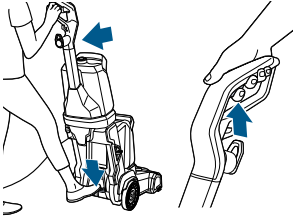
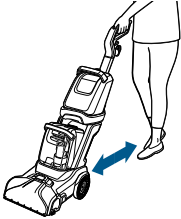
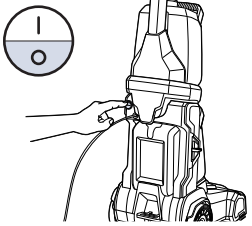
		
<p><b>4.</b> Press the recline pedal with your foot. Hold the Spray Trigger for 10 seconds to prime the system with cleaning solution.</p>	<p><b>5.</b> Make forward and backward passes based on your selected cleaning mode. See "Cleaning Modes &amp; Instructions" below.</p>	<p><b>6.</b> When finished, turn machine OFF.</p>

**Note:** When solution is flowing, bubbles will form at the edges of the nozzle. Holding the trigger continuously may result in overwetting your carpet.

## Cleaning Modes & Instructions

<p><b>Deep Clean Mode</b> Delivers a deep clean to your carpet.</p> <ol style="list-style-type: none"><li>1. Hold Spray Trigger<ul style="list-style-type: none"><li>• 1 pass forward</li><li>• 1 pass back</li></ul></li><li>2. Release the Spray Trigger<ul style="list-style-type: none"><li>• 1 pass forward</li><li>• 1 pass back</li></ul></li></ol>	<p><b>Deep Clean Mode with BISSELL® Deep Clean + Antibacterial Formula</b></p> <ol style="list-style-type: none"><li>1. Hold Spray Trigger<ul style="list-style-type: none"><li>• 1 pass forward</li><li>• 1 pass back</li><li>• 1 pass forward</li></ul></li><li>2. Release the Spray Trigger<ul style="list-style-type: none"><li>• 1 pass back</li></ul></li></ol>	<p><b>Express Clean Mode</b> Provides a lighter clean that dries in about 45 minutes.</p> <ol style="list-style-type: none"><li>1. Hold Spray Trigger<ul style="list-style-type: none"><li>• 1 pass forward</li><li>• 1 pass back</li></ul></li><li>2. Release the Spray Trigger<ul style="list-style-type: none"><li>• 1 pass forward</li><li>• 1 pass back</li></ul></li></ol>
--	---	--

# Cleaning with the Hose and Tool

Visit [support.BISSELL.com](http://support.BISSELL.com) for helpful tips and tricks on using your machine's tools.

## Tips Before Cleaning

- Check for colorfastness in an inconspicuous place before cleaning larger area.
- If possible, check upholstery stuffing. Colored stuffing may bleed through fabric when wet.
- Vacuum thoroughly to pick up loose debris and pet hair.
- Check manufacturer's tag before cleaning. Do not use on velvet or silk.
- The Brush Roll remains on while cleaning with the hose and tool. Do not allow cleaner to sit in one location for an extended period of time, as damage to floor can result.

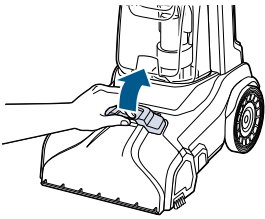
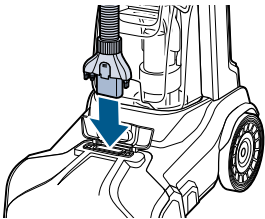
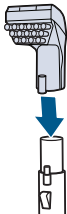
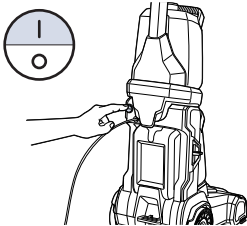
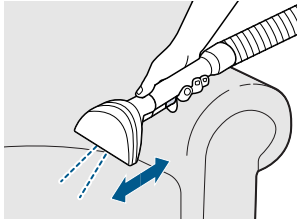
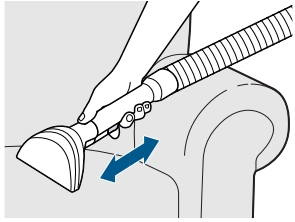
		
<p><b>1.</b> Lift the Accessory Hose Door on top of Foot on the front of the machine. The door flips toward the machine to open.</p>	<p><b>2.</b> Insert the hose and snap into place. Be sure the colored hose release clip is facing out, away from machine.</p>	<p><b>3.</b> Attach the tool to the end of the hose.</p>
		
<p><b>4.</b> Press the power button to turn the machine ON.</p>	<p><b>5.</b> Hold tool about 1 inch above soiled surface. Press Spray Trigger to apply cleaning solution.</p>	<p><b>6.</b> Release trigger, apply downward pressure, and pull toward you to suction up dirt and cleaning solution. Do not overwet.</p>

# Emptying the Dirty Water Tank

For helpful how-to videos about maintaining your machine visit [support.BISSELL.com](https://support.BISSELL.com).

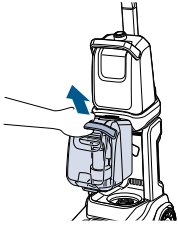

**1.** Pull Dirty Water Tank up and away to remove.

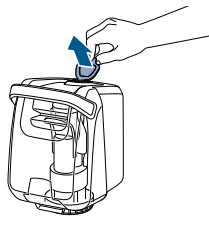

**2.** For quick empty: Pull the rubber tab (located in the middle of the tank) and tilt to pour. When closing the rubber tab, make sure all edges are sealed tight.

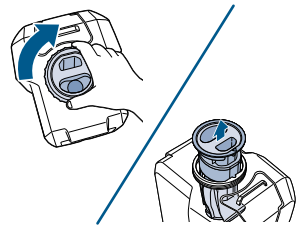

**3.** For final clean and rinse: Unscrew the ring at the bottom of tank. Gently remove the float stack, rinse and return to the tank lining up the arrows locking into place. Return the ring and twist to lock.

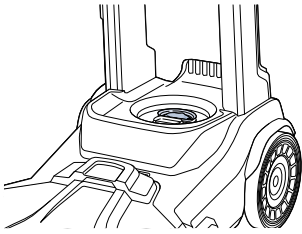

**4.** Clean the red filter below the Dirty Water Tank by wiping off any remaining dirt or debris.

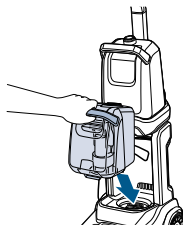

**5.** To replace Dirty Water Tank angle it by placing the bottom in first. Then, tilt it toward the machine and push it until it “clicks” into place.

**⚠ WARNING** To reduce the risk of fire, electric shock or injury, turn power OFF and disconnect plug from electrical outlet before performing maintenance or troubleshooting.

## After-Cleaning Care

➤ Visit [support.BISSELL.com](http://support.BISSELL.com) for additional how-to videos on maintaining your machine.

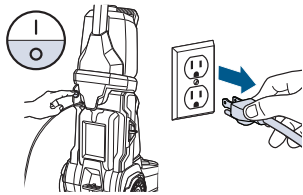

**1.** Turn OFF and unplug the machine.

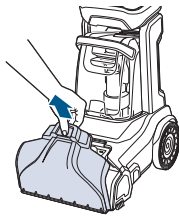

**2.** Remove the nozzle from the foot by lifting up on the back of the Accessory Hose Door to open.

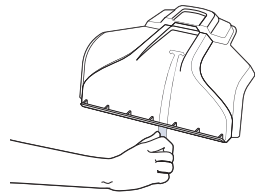

**3.** Hold the nozzle and insert the Nozzle Clean Out Tool into the thin slot at the front of the nozzle where it touches the floor. Clean out pet hair or debris.

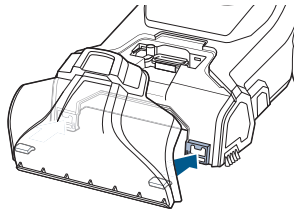

**4.** Return the nozzle to the Foot of the machine. Line up the two hooks on the nozzle to the bottom of the foot.

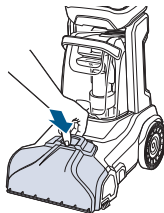

**5.** Rotate the nozzle down and click into place.

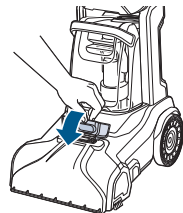

**6.** Close the Accessory Hose Door.

## Cleaning the Brush Roll

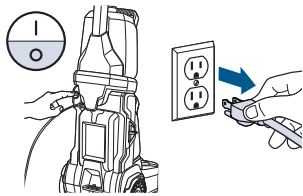

**1.** Turn OFF and unplug the machine.

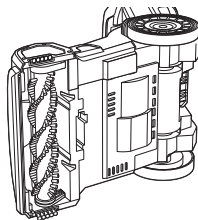

**2.** Lay the machine down on its back or side.

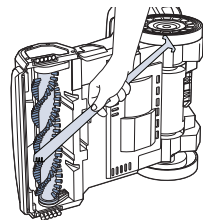

**3.** Use the comb to remove debris or hair from the brush rolls.

**⚠ WARNING** To reduce the risk of fire, electric shock or injury, turn power OFF and disconnect plug from electrical outlet before performing maintenance or troubleshooting.

## Replacing the Belts and Brush Rolls

➤ For replacement parts, head to [BISSELL.com/parts](http://BISSELL.com/parts).

Required for Maintenance



Phillips-head Screwdriver

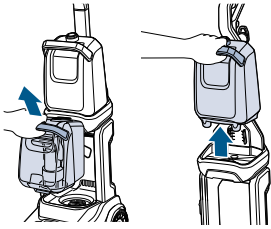

**1.** Unplug the machine. Remove both tanks. With the machine reclined, locate the belt access cover and lay the machine on its side.

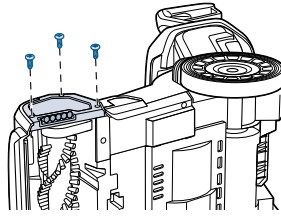

**2.** Remove the 3 screws on the brush access cover using a Phillips-head screwdriver. Remove the access cover to expose the cogged belt and brush roll.

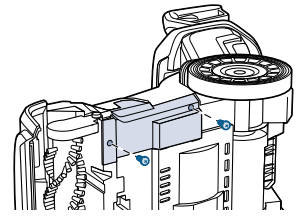

**3.** Remove the 2 screws on the belt access cover using a Phillips-head screwdriver. Remove the access plate to expose the flat pump belt. If flat pump belt is broken, you may gently remove it from the machine. We will replace this belt in Step 5.

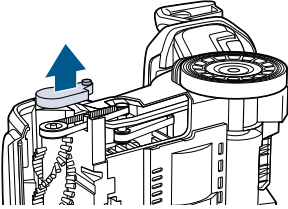

**4.** Remove the brush cover by lifting straight up. Remove the cogged large pump belt. The brush rolls can be replaced or cleaned at this time, if needed.

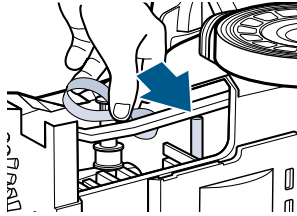

**5.** If the flat pump belt is broken, place a new belt around the red area of the large pulley. Use your thumb to stretch it toward the back of the machine and transfer it onto the metal axle.

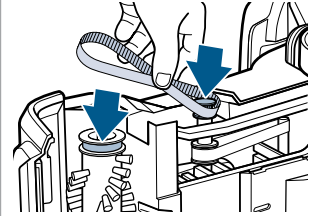

**6.** To replace the cogged pump belt, wrap the new belt around the small metal-toothed pulley. While wrapped around the pulley, stretch around the pulley, stretch and wrap around the brush gear.

## Storing Your Machine

➤ For more helpful maintenance tips, check out [support.BISSELL.com](http://support.BISSELL.com).

Once your cleaning is complete, make sure both the Dirty and Clean Water Tanks are emptied, rinsed out and dried before the next use. Wrap cord around cord wrap for storage. Store machine in a protected, dry area.

**NOTICE** To reduce the risk of a leaking condition, do not store unit where freezing may occur. Damage to internal components may result.

**⚠ WARNING** To reduce the risk of fire, electric shock or injury, turn power OFF and disconnect plug from electrical outlet before performing maintenance or troubleshooting.

## Troubleshooting

Below are some of the issues you may run into. If you don't see the issue you're experiencing below, visit [support.BISSELL.com](http://support.BISSELL.com).

Problem	Possible Cause	Remedies
Reduced spray OR no spray	Clean Water Tank may be empty.	Refill tank.
	Clean Water Tank may not be seated completely.	Turn power OFF. Remove and reseal tank.
	Pump may have lost prime in hose cleaning mode.	Hold end of hose below water level in tank to prime.
No spray through hose & tool	The hose to your machine is not primed.	With the machine OFF and unplugged, remove the nozzle from the foot. Place a ballpoint pen in the black cylinder next to the screw. When water bubbles up, remove the pen. Reassemble the nozzle and hose.
Loss of suction power	Tanks may not be seated properly.	Pick up both tanks and reseal them so they fit properly.
	Dirty Water Tank has picked up maximum amount of dirty water and has reached full line.	Empty Dirty Water Tank.
	Clean Water Tank is empty.	Check fluid levels in the Clean Water Tank. Refill the tank if it is empty.
	Rubber tab on Dirty Water Tank is not sealed tight.	Check the rubber tab on the Dirty Water Tank and press firmly on all edges to secure it tightly (see step 2 on page 8 for details).
	Accessory Hose Door may not be closed tightly in place.	Check the Accessory Hose Door and make sure it is closed tightly – it should be locked into place.
	Nozzle may be clogged from pet hair or debris.	Use the Nozzle Clean Out Tool and follow steps on page 9 for “Cleaning the Nozzle”.
	Nozzle not installed correctly.	Remove and reinstall nozzle.
No power	Cleaning mode switch mistaken for power button.	Press the power button on the left side of the machine to turn the machine ON.
	Outlet may not be active.	Try plugging in a different device that uses a grounded outlet to test for power from the outlet.
Leaking Clean Water Tank	Tank may have been overfilled	<ol style="list-style-type: none"> <li>1. Make sure your tank has the water and formula in it that you've prepared.</li> <li>2. With the cap twisted ON tightly, hold your tank at an angle, over a sink or drain, so any extra water can pour out of the space.</li> <li>3. Wipe the tank dry with a cloth.</li> </ol>
	Water may be caught in space between the tank and the tank's handle.	
Leaking Dirty Water Tank	Tank ring not installed properly.	Remove tank. Remove and reinstall tank ring.

**Note:** Any other servicing should be performed by an authorized service representative.



## We're Waggin' Our Tails!

BISSELL® proudly supports BISSELL Pet Foundation® and its mission to help save homeless pets. When you buy a BISSELL product, you help save pets, too. We're proud to design products that help make pet messes, odors and pet homelessness disappear.

Visit [BISSELLsavespets.com](https://www.bissellsavespets.com) to learn more.

## But wait, there's more!

Join us online for a complete guide to your new product, including troubleshooting, product registration, parts, and more.

Go to [support.BISSELL.com](https://support.bissell.com).



REGISTER



INFO



VIDEOS



PARTS



SUPPORT



©2021 BISSELL Inc. All rights reserved.  
Part Number 1625956 11/20