

ASRock®

Q1900M

D1800M

User Manual



Version 1.2

Published November 2014

Copyright©2014 ASRock INC. All rights reserved.

Copyright Notice:

No part of this documentation may be reproduced, transcribed, transmitted, or translated in any language, in any form or by any means, except duplication of documentation by the purchaser for backup purpose, without written consent of ASRock Inc.

Products and corporate names appearing in this documentation may or may not be registered trademarks or copyrights of their respective companies, and are used only for identification or explanation and to the owners' benefit, without intent to infringe.

Disclaimer:

Specifications and information contained in this documentation are furnished for informational use only and subject to change without notice, and should not be constructed as a commitment by ASRock. ASRock assumes no responsibility for any errors or omissions that may appear in this documentation.

With respect to the contents of this documentation, ASRock does not provide warranty of any kind, either expressed or implied, including but not limited to the implied warranties or conditions of merchantability or fitness for a particular purpose.

In no event shall ASRock, its directors, officers, employees, or agents be liable for any indirect, special, incidental, or consequential damages (including damages for loss of profits, loss of business, loss of data, interruption of business and the like), even if ASRock has been advised of the possibility of such damages arising from any defect or error in the documentation or product.

The terms HDMI™ and HDMI High-Definition Multimedia Interface, and the HDMI logo are trademarks or registered trademarks of HDMI Licensing LLC in the United States and other countries.



This device complies with Part 15 of the FCC Rules. Operation is subject to the following two conditions:

- (1) this device may not cause harmful interference, and
- (2) this device must accept any interference received, including interference that may cause undesired operation.

CALIFORNIA, USA ONLY

The Lithium battery adopted on this motherboard contains Perchlorate, a toxic substance controlled in Perchlorate Best Management Practices (BMP) regulations passed by the California Legislature. When you discard the Lithium battery in California, USA, please follow the related regulations in advance.

“Perchlorate Material-special handling may apply, see www.dtsc.ca.gov/hazardouswaste/perchlorate”

ASRock Website: <http://www.asrock.com>

AUSTRALIA ONLY

Our goods come with guarantees that cannot be excluded under the Australian Consumer Law. You are entitled to a replacement or refund for a major failure and compensation for any other reasonably foreseeable loss or damage caused by our goods. You are also entitled to have the goods repaired or replaced if the goods fail to be of acceptable quality and the failure does not amount to a major failure. If you require assistance please call ASRock Tel : +886-2-28965588 ext.123 (Standard International call charges apply)

The terms HDMI™ and HDMI High-Definition Multimedia Interface, and the HDMI logo are trademarks or registered trademarks of HDMI Licensing LLC in the United States and other countries.



Contents

Chapter 1 Introduction	1
1.1 Package Contents	1
1.2 Specifications	2
1.3 Motherboard Layout	5
1.4 I/O Panel	7
Chapter 2 Installation	8
2.1 Installing Memory Modules (DIMM)	9
2.2 Expansion Slots (PCI Express Slots)	11
2.3 Jumpers Setup	12
2.4 Onboard Headers and Connectors	13
Chapter 3 Software and Utilities Operation	17
3.1 Installing Drivers	17
3.2 A-Tuning	18
3.3 Intel® Smart Connect Technology	20
3.4 Start8	25
Chapter 4 UEFI SETUP UTILITY	28
4.1 Introduction	28
4.1.1 UEFI Menu Bar	28
4.1.2 Navigation Keys	29
4.2 Main Screen	30
4.3 Advanced Screen	31
4.3.1 CPU Configuration	32

4.3.2	Chipset Configuration	34
4.3.3	Storage Configuration	36
4.3.4	Intel® Smart Connect Technology	37
4.3.5	Super IO Configuration	38
4.3.6	ACPI Configuration	39
4.3.7	USB Configuration	41
4.3.8	Trusted Computing	42
4.4	Tools	43
4.5	Hardware Health Event Monitoring Screen	45
4.6	Security Screen	46
4.7	Boot Screen	47
4.8	Exit Screen	49

Chapter 1 Introduction

Thank you for purchasing ASRock Q1900M / D1800M motherboard, a reliable motherboard produced under ASRock's consistently stringent quality control. It delivers excellent performance with robust design conforming to ASRock's commitment to quality and endurance.

In this manual, Chapter 1 and 2 contains the introduction of the motherboard and step-by-step installation guides. Chapter 3 contains the operation guide of the software and utilities. Chapter 4 contains the configuration guide of the BIOS setup.



Because the motherboard specifications and the BIOS software might be updated, the content of this documentation will be subject to change without notice. In case any modifications of this documentation occur, the updated version will be available on ASRock's website without further notice. If you require technical support related to this motherboard, please visit our website for specific information about the model you are using. You may find the latest VGA cards and CPU support list on ASRock's website as well. ASRock website <http://www.asrock.com>.

1.1 Package Contents

- ASRock Q1900M / D1800M Motherboard (Micro ATX Form Factor)
- ASRock Q1900M / D1800M Quick Installation Guide
- ASRock Q1900M / D1800M Support CD
- 2 x Serial ATA (SATA) Data Cables (Optional)
- 1 x I/O Panel Shield

1.2 Specifications

- Platform**
- Micro ATX Form Factor
 - All Solid Capacitor design
 - High Density Glass Fabric PCB

- CPU**
- Intel® Quad-Core Processor J1900 (2 GHz) **(for Q1900M)**
 - Intel® Dual-Core Processor J1800 (2.41 GHz) **(for D1800M)**

- Memory**
- Dual Channel DDR3/DDR3L Memory Technology
 - 2 x DDR3/DDR3L DIMM Slots
 - Supports DDR3/DDR3L 1333/1066 non-ECC, un-buffered memory
 - Max. capacity of system memory: 16GB (see CAUTION)

- Expansion Slot**
- 1 x PCI Express 2.0 x16 Slot (PCIE2 @ x1 mode)
 - 2 x PCI Express 2.0 x1 Slots

- Graphics**
- Intel® 7th generation (Gen 7) graphics
 - DirectX 11.0, Pixel Shader 5.0
 - Three graphics output options: D-Sub, DVI-D and HDMI
 - Supports HDMI Technology with max. resolution up to 1920x1200 @ 60Hz
 - Supports DVI-D with max. resolution up to 1920x1200 @ 60Hz
 - Supports D-Sub with max. resolution up to 1920x1200 @ 60Hz
 - Supports Auto Lip Sync, Deep Color (12bpc), xvYCC and HBR (High Bit Rate Audio) with HDMI Port (Compliant HDMI monitor is required)
 - Supports HDCP with DVI-D and HDMI Ports
 - Supports Full HD 1080p Blu-ray (BD) playback with DVI-D and HDMI Ports

- Audio**
- 5.1 CH HD Audio (Realtek ALC662 Audio Codec)
 - Supports Surge Protection (ASRock Full Spike Protection)

LAN

- PCIE x1 Gigabit LAN 10/100/1000 Mb/s
- Realtek RTL8111GR
- Supports Wake-On-WAN
- Supports Wake-On-LAN
- Supports Lightning/ESD Protection (ASRock Full Spike Protection)
- Supports LAN Cable Detection
- Supports Energy Efficient Ethernet 802.3az
- Supports PXE

Rear Panel I/O

- 1 x PS/2 Mouse Port
- 1 x PS/2 Keyboard Port
- 1 x D-Sub Port
- 1 x DVI-D Port
- 1 x HDMI Port
- 3 x USB 2.0 Ports (Supports ESD Protection (ASRock Full Spike Protection))
- 1 x USB 3.0 Port (Supports ESD Protection (ASRock Full Spike Protection))
- 1 x RJ-45 LAN Port with LED (ACT/LINK LED and SPEED LED)
- HD Audio Jacks: Line in / Front Speaker / Microphone

Storage

- 2 x SATA2 3.0 Gb/s Connectors, support NCQ, AHCI and Hot Plug

Connector

- 1 x Print Port Header
- 1 x COM Port Header
- 1 x TPM Header
- 1 x Chassis Intrusion Header
- 1 x CPU Fan Connector (3-pin)
- 1 x Chassis Fan Connector (3-pin)
- 1 x 24 pin ATX Power Connector
- 1 x Front Panel Audio Connector
- 2 x USB 2.0 Headers (Support 3 USB 2.0 ports) (Supports ESD Protection (ASRock Full Spike Protection))

**BIOS
Feature**

- 64Mb AMI UEFI Legal BIOS with GUI support
- Supports Plug and Play
- ACPI 1.1 compliant wake up events
- Supports jumperfree
- SMBIOS 2.3.1 support

**Hardware
Monitor**

- CPU/Chassis temperature sensing
- CPU/Chassis Fan Tachometer
- CPU/Chassis Quiet Fan (Auto adjust chassis fan speed by CPU temperature)
- CPU/Chassis Fan multi-speed control
- CASE OPEN detection
- Supports CPU Fanless
- Voltage monitoring: +12V, +5V, +3.3V, CPU Vcore

OS

- Microsoft® Windows® 8.1 32-bit / 8.1 64-bit / 8 32-bit / 8 64-bit / 7 32-bit / 7 64-bit

**Certifica-
tions**

- FCC, CE, WHQL
- ErP/EuP ready (ErP/EuP ready power supply is required)

* For detailed product information, please visit our website: <http://www.asrock.com>



Due to limitation, the actual memory size may be less than 4GB for the reservation for system usage under Windows® 32-bit operating systems. Windows® 64-bit operating systems do not have such limitations. You can use ASRock XFast RAM to utilize the memory that Windows® cannot use.

1.3 Motherboard Layout

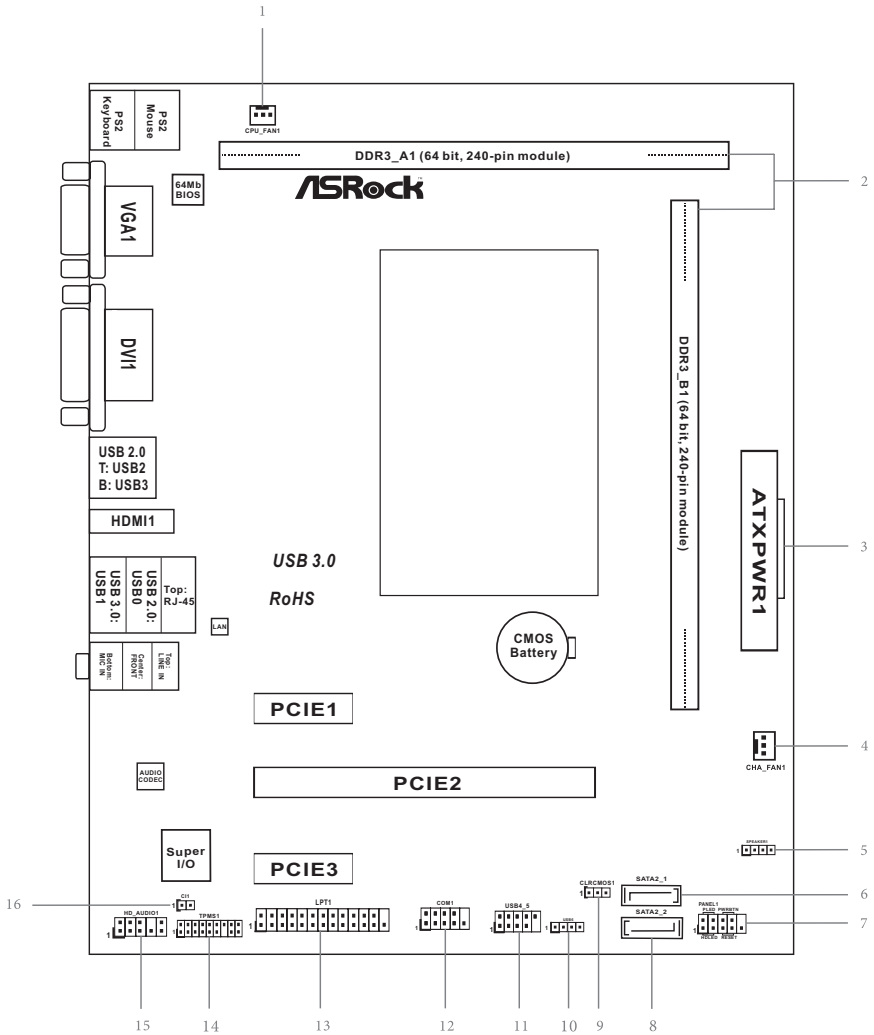

No.	Description
-----	-------------

- | | |
|----|--|
| 1 | CPU Fan Connector (CPU_FAN1) |
| 2 | 2 x 240-pin DDR3 DIMM Slots (DDR3_A1, DDR3_B1) |
| 3 | ATX Power Connector (ATXPWR1) |
| 4 | Chassis Fan Connector (CHA_FAN1) |
| 5 | Chassis Speaker Header (SPEAKER1) |
| 6 | SATA2 Connector (SATA2_1) |
| 7 | System Panel Header (PANEL1) |
| 8 | SATA2 Connector (SATA2_2) |
| 9 | Clear CMOS Jumper (CLRCMOS1) |
| 10 | USB 2.0 Header (USB6) |
| 11 | USB 2.0 Header (USB4_5) |
| 12 | COM Port Header (COM1) |
| 13 | Print Port Header (LPT1) |
| 14 | TPM Header (TPMS1) |
| 15 | Front Panel Audio Header (HD_AUDIO1) |
| 16 | Chassis Intrusion Header (CI1) |

1.4 I/O Panel

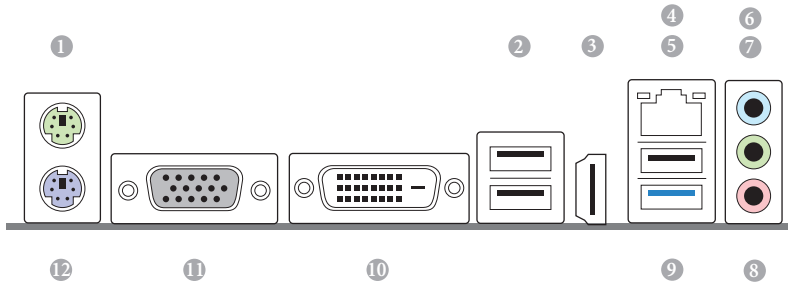

No.	Description	No.	Description
1	PS/2 Mouse Port	7	Front Speaker (Lime)
2	USB 2.0 Ports (USB_23)	8	Microphone (Pink)
3	HDMI Port	9	USB 3.0 Port (USB1)
4	LAN RJ-45 Port*	10	DVI-D Port
5	USB 2.0 Port (USB0)	11	D-Sub Port
6	Line In (Light Blue)	12	PS/2 Keyboard Port

* There are two LEDs on each LAN port. Please refer to the table below for the LAN port LED indications.

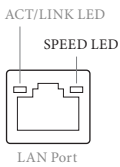

Activity / Link LED		Speed LED	
Status	Description	Status	Description
Off	No Link	Off	10Mbps connection
Blinking	Data Activity	Orange	100Mbps connection
On	Link	Green	1Gbps connection

Chapter 2 Installation

This is a Micro ATX form factor motherboard. Before you install the motherboard, study the configuration of your chassis to ensure that the motherboard fits into it.

Pre-installation Precautions

Take note of the following precautions before you install motherboard components or change any motherboard settings.

- Make sure to unplug the power cord before installing or removing the motherboard. Failure to do so may cause physical injuries to you and damages to motherboard components.
- In order to avoid damage from static electricity to the motherboard's components, NEVER place your motherboard directly on a carpet. Also remember to use a grounded wrist strap or touch a safety grounded object before you handle the components.
- Hold components by the edges and do not touch the ICs.
- Whenever you uninstall any components, place them on a grounded anti-static pad or in the bag that comes with the components.
- When placing screws to secure the motherboard to the chassis, please do not over-tighten the screws! Doing so may damage the motherboard.

2.1 Installing Memory Modules (DIMM)

This motherboard provides two 240-pin DDR3/DDR3L (Double Data Rate 3) DIMM slots. If only one DIMM module is installed, please install it into DDR3_A1.



It is not allowed to install a DDR or DDR2 memory module into a DDR3/DDR3L slot; otherwise, this motherboard and DIMM may be damaged.



The DIMM only fits in one correct orientation. It will cause permanent damage to the motherboard and the DIMM if you force the DIMM into the slot at incorrect orientation.

1

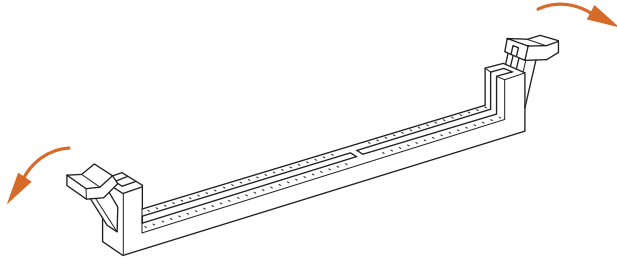

2

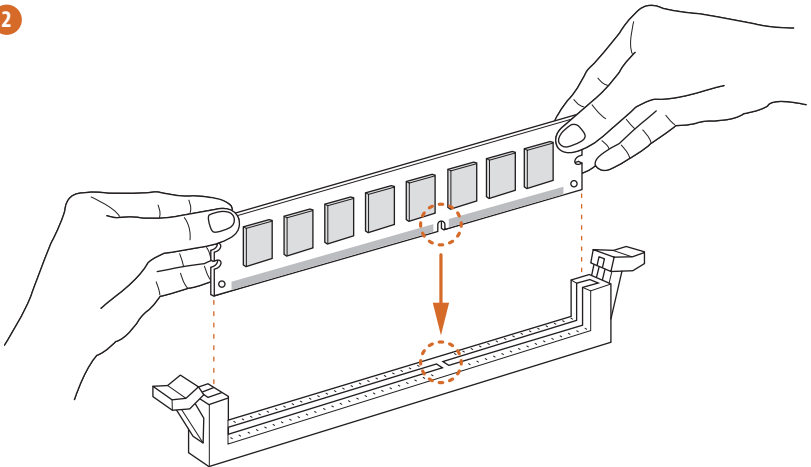

3

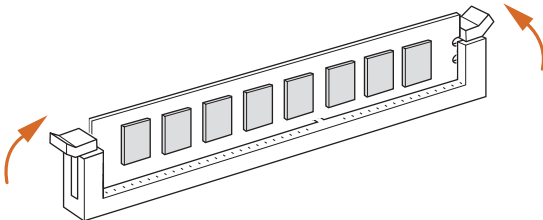

2.2 Expansion Slots (PCI Express Slots)

There are 3 PCI Express slots on the motherboard.



Before installing an expansion card, please make sure that the power supply is switched off or the power cord is unplugged. Please read the documentation of the expansion card and make necessary hardware settings for the card before you start the installation.

PCIe slots:

PCIE1 (PCIe 2.0 x1 slot) is used for PCI Express x1 lane width cards.

PCIE2 (PCIe 2.0 x16 slot) is used for PCI Express x1 lane width cards.

PCIE3 (PCIe 2.0 x1 slot) is used for PCI Express x1 lane width cards.

2.3 Jumpers Setup

The illustration shows how jumpers are setup. When the jumper cap is placed on the pins, the jumper is “Short”. If no jumper cap is placed on the pins, the jumper is “Open”. The illustration shows a 3-pin jumper whose pin1 and pin2 are “Short” when a jumper cap is placed on these 2 pins.

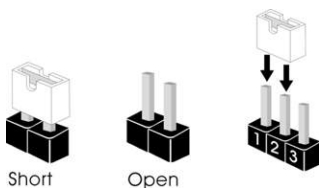

Clear CMOS Jumper
(CLR CMOS1)
(see p.5, No. 9)

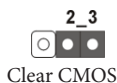

CLR CMOS1 allows you to clear the data in CMOS. To clear and reset the system parameters to default setup, please turn off the computer and unplug the power cord from the power supply. After waiting for 15 seconds, use a jumper cap to short pin2 and pin3 on CLR CMOS1 for 5 seconds. However, please do not clear the CMOS right after you update the BIOS. If you need to clear the CMOS when you just finish updating the BIOS, you must boot up the system first, and then shut it down before you do the clear-CMOS action. Please be noted that the password, date, time, and user default profile will be cleared only if the CMOS battery is removed.



If you clear the CMOS, the case open may be detected. Please adjust the BIOS option “Clear Status” to clear the record of previous chassis intrusion status.

2.4 Onboard Headers and Connectors



Onboard headers and connectors are NOT jumpers. Do NOT place jumper caps over these headers and connectors. Placing jumper caps over the headers and connectors will cause permanent damage to the motherboard.

System Panel Header
(9-pin PANEL1)
(see p.5, No. 7)

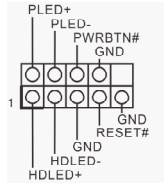

Connect the power switch, reset switch and system status indicator on the chassis to this header according to the pin assignments below. Note the positive and negative pins before connecting the cables.



PWRBTN (Power Switch):

Connect to the power switch on the chassis front panel. You may configure the way to turn off your system using the power switch.

RESET (Reset Switch):

Connect to the reset switch on the chassis front panel. Press the reset switch to restart the computer if the computer freezes and fails to perform a normal restart.

PLED (System Power LED):

Connect to the power status indicator on the chassis front panel. The LED is on when the system is operating. The LED keeps blinking when the system is in S1/S3 sleep state. The LED is off when the system is in S4 sleep state or powered off (S5).

HDLED (Hard Drive Activity LED):

Connect to the hard drive activity LED on the chassis front panel. The LED is on when the hard drive is reading or writing data.

The front panel design may differ by chassis. A front panel module mainly consists of power switch, reset switch, power LED, hard drive activity LED, speaker and etc. When connecting your chassis front panel module to this header, make sure the wire assignments and the pin assignments are matched correctly.

Serial ATA2 Connectors

(SATA2_1:
see p.5, No. 6)
(SATA2_2:
see p.5, No. 8)



These two SATA2 connectors support SATA data cables for internal storage devices with up to 3.0 Gb/s data transfer rate.

USB 2.0 Headers
(9-pin USB4_5)
(see p.5, No. 11)

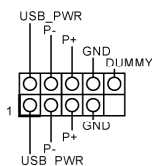

Besides three USB 2.0 ports on the I/O panel, there are two headers on this motherboard.

(4-pin USB6)
(see p.5, No. 10)



Front Panel Audio Header
(9-pin HD_AUDIO1)
(see p.5, No. 15)

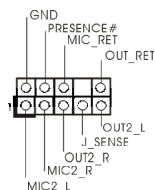

This header is for connecting audio devices to the front audio panel.



1. High Definition Audio supports Jack Sensing, but the panel wire on the chassis must support HDA to function correctly. Please follow the instructions in our manual and chassis manual to install your system.
2. If you use an AC'97 audio panel, please install it to the front panel audio header by the steps below:
 - A. Connect Mic_IN (MIC) to MIC2_L.
 - B. Connect Audio_R (RIN) to OUT2_R and Audio_L (LIN) to OUT2_L.
 - C. Connect Ground (GND) to Ground (GND).
 - D. MIC_RET and OUT_RET are for the HD audio panel only. You don't need to connect them for the AC'97 audio panel.
 - E. To activate the front mic, go to the "FrontMic" Tab in the Realtek Control panel and adjust "Recording Volume".

Chassis Speaker Header
(4-pin SPEAKER1)
(see p.5, No. 5)

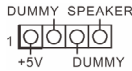

Please connect the chassis speaker to this header.

Chassis Fan Connector
(3-pin CHA_FAN1)
(see p.5, No. 4)



Please connect fan cable to the fan connector and match the black wire to the ground pin.

CPU Fan Connectors
(3-pin CPU_FAN1)
(see p.5, No. 1)



Please connect the CPU fan cable to the connector and match the black wire to the ground pin.

ATX Power Connector
(24-pin ATXPWR1)
(see p.5, No. 3)

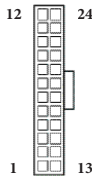

This motherboard provides a 24-pin ATX power connector. To use a 20-pin ATX power supply, please plug it along Pin 1 and Pin 13.

Chassis Intrusion Header
(2-pin CII)
(see p.5, No. 16)



This motherboard supports CASE OPEN detection feature that detects if the chassis cover has been removed. This feature requires a chassis with chassis intrusion detection design.

TPM Header
(17-pin TPMS1)
(see p.5, No. 14)

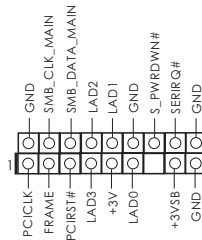

This connector supports Trusted Platform Module (TPM) system, which can securely store keys, digital certificates, passwords, and data. A TPM system also helps enhance network security, protects digital identities, and ensures platform integrity.

Serial Port Header
(9-pin COM1)
(see p.5, No. 12)

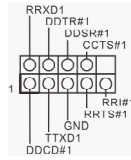

This COM1 header supports a serial port module.

Print Port Header
(25-pin LPT1)
(see p.5, No. 13)

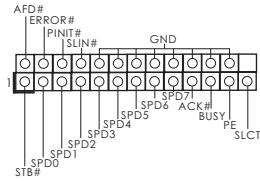

This is an interface for print port cable that allows convenient connection of printer devices.

Chapter 3 Software and Utilities Operation

3.1 Installing Drivers

The Support CD that comes with the motherboard contains necessary drivers and useful utilities that enhance the motherboard's features.

Running The Support CD

To begin using the support CD, insert the CD into your CD-ROM drive. The CD automatically displays the Main Menu if "AUTORUN" is enabled in your computer. If the Main Menu does not appear automatically, locate and double click on the file "ASRSETUP.EXE" in the Support CD to display the menu.

Drivers Menu

The drivers compatible to your system will be auto-detected and listed on the support CD driver page. Please click **Install All** or follow the order from top to bottom to install those required drivers. Therefore, the drivers you install can work properly.

Utilities Menu

The Utilities Menu shows the application software that the motherboard supports. Click on a specific item then follow the installation wizard to install it.



To improve Windows 7 compatibility, please download and install the following hot fix provided by Microsoft.

"KB2720599": <http://support.microsoft.com/kb/2720599/en-us>

3.2 A-Tuning

A-Tuning is ASRock's multi purpose software suite with a new interface, more new features and improved utilities, including XFast RAM and a whole lot more.

3.2.1 Installing A-Tuning

When you install the all-in-one driver to your system from ASRock's support CD, A-Tuning will be auto-installed as well. After the installation, you will find the icon "A-Tuning" on your desktop. Double-click the "A-Tuning" icon, A-Tuning main menu will pop up.



3.2.2 Using A-Tuning

There are five sections in A-Tuning main menu: Operation Mode and Tools.

Operation Mode

Choose an operation mode for your computer.

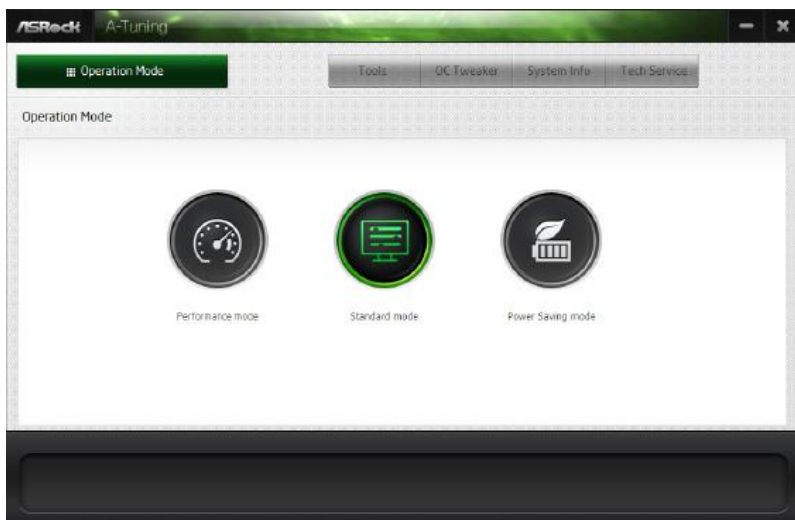

Tools

Various tools and utilities.

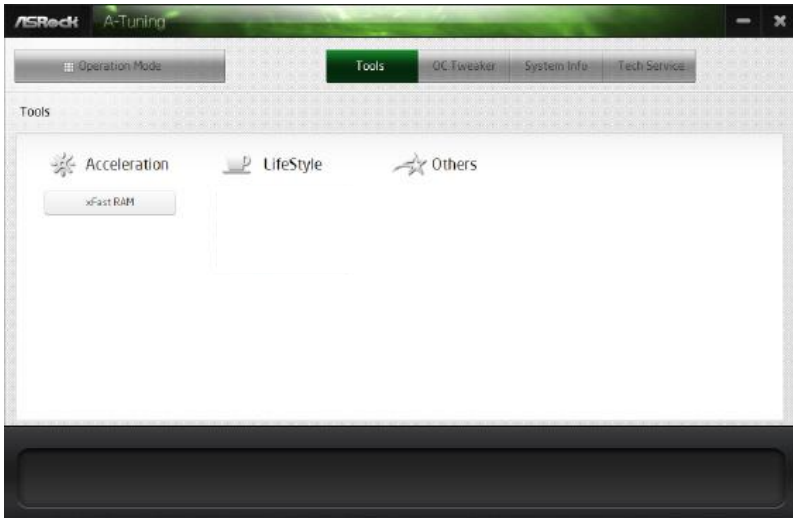

XFast RAM

Boost the system's performance and extend the HDD's or SSD's lifespan! Create a hidden partition, then assign which files should be stored in the RAM drive.

3.3 Intel® Smart Connect Technology

Intel® Smart Connect Technology is a feature that periodically wakes your computer from Windows® sleep state to refresh email or social networking applications. It saves your waiting time and keeps the content always up-to-date.

3.3.1 System Requirements

- Confirm whether your motherboard supports this feature.
- Operating system: Microsoft Windows 8/7 (32- or 64-bit edition)
- Set the SATA mode to AHCI. If Windows 8/7 is already installed under IDE mode, directly changing the SATA mode to AHCI may cause Windows 8/7 to crash while booting. If your system is not in AHCI mode, please follow the instructions below.



There are certain risks. Please backup any important data before operating to avoid loss.

1. Press **Win + R** simultaneously in Windows 8/7, type "Regedit" into the word box then click **OK**.

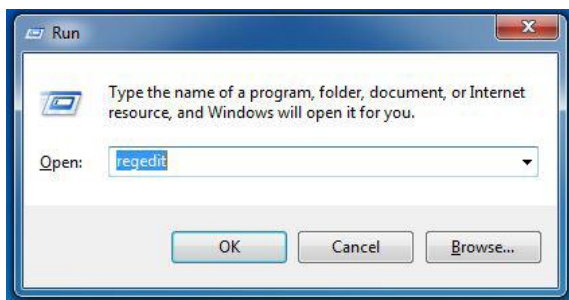

2. Enter into **HKEY_LOCAL_MACHINE\SYSTEM\CurrentControlSet\services\msahci** in Windows Registry Editor. Double click on the value **Start** and change the value from **3** into **0**. Click on **OK**.

3.3.2 Setup Guide

Installing ASRock Smart Connect Utility

Step 1

Install **ASRock Smart Connect Utility**, which is located in the folder at the following path of the Support CD: \ **ASRock Utility** > **Smart Connect**.

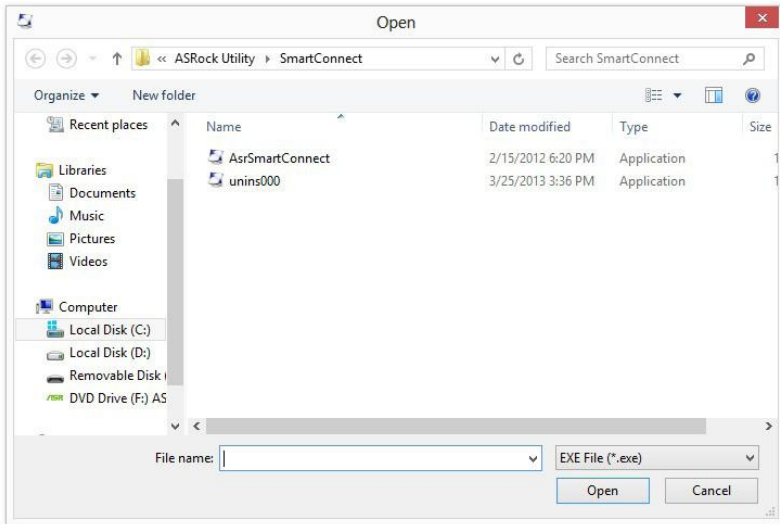

Step 2

Once installed, run ASRock Smart Connect from your desktop or go to Windows **Start -> All Programs -> ASRock Utility**.



Step 3

Click the **Add** button. Take Foxmail as an example, add Foxmail to the Application list.

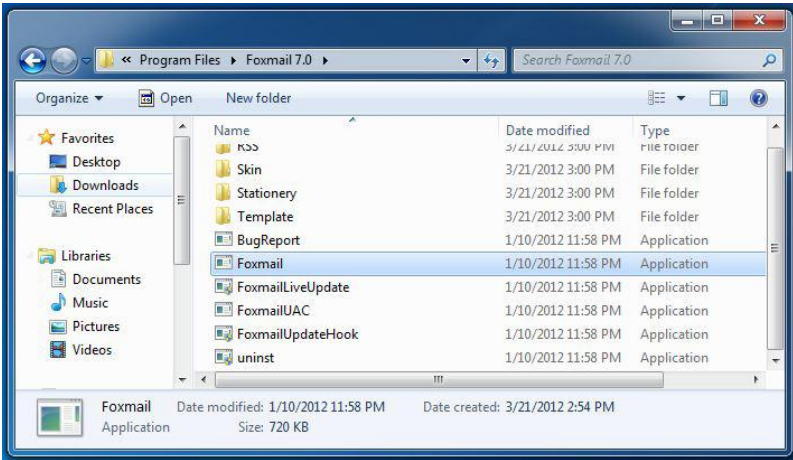

Step 4

Select Foxmail from the **Application List**, then click the arrow pointing right to add this application to the **Smart Connect List**.



Step 5

Click **Apply** to enable Smart Connect.

Step 6

Double-click the Intel® Smart Connect Technology Manager icon  in the Windows system tray.

Step 7

Drag the slider to configure how often the system will connect to the network to download updates. Shorter durations will provide more frequent updates, but may cause more power consumption.

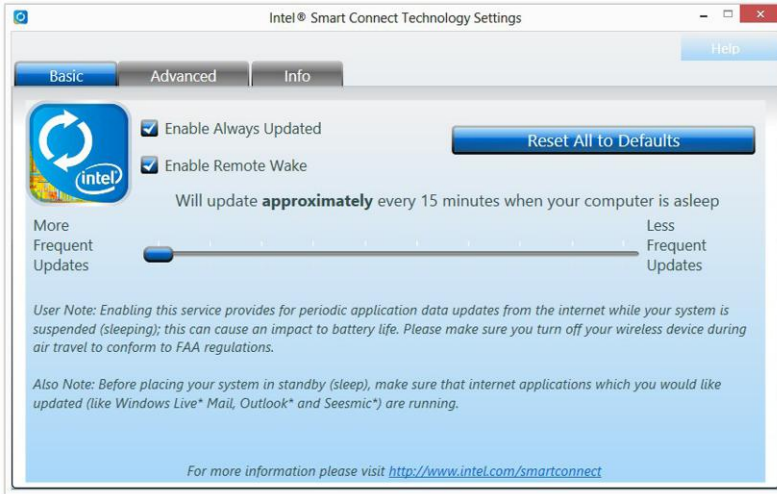
**Using Smart Connect**

1. Keep the applications which you wish to connect to the internet and receive updates while the system is in sleep state running. Foxmail for instance, keep Foxmail running.
2. Click on Windows Start -> the arrow next to Shut down, and click on **Sleep**.

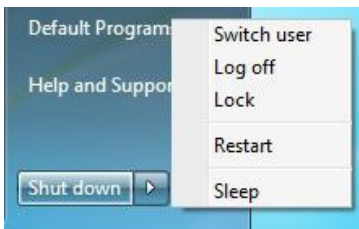

3. Windows system will enter sleep state.

4. The system will wake up from sleep state periodically, and then start to update Foxmail. The screen will not display anything so the computer can maintain minimum power usage. Afterwards, the system will automatically return to sleep state again.
5. Upon waking up the system, you will find the new mail that were sent to you during sleep state are already updated and ready to be read in Foxmail.

3.4 Start8

For those Windows 8 users who miss the Start Menu, Start8 is an ideal solution that brings back the familiar Start Menu along with added customizations for greater efficiency.

3.4.1 Installing Start8

Install **Start8**, which is located in the folder at the following path of the Support CD:
 \ **ASRock Utility** > **Start8**.

3.4.2 Configuring Start8

Style

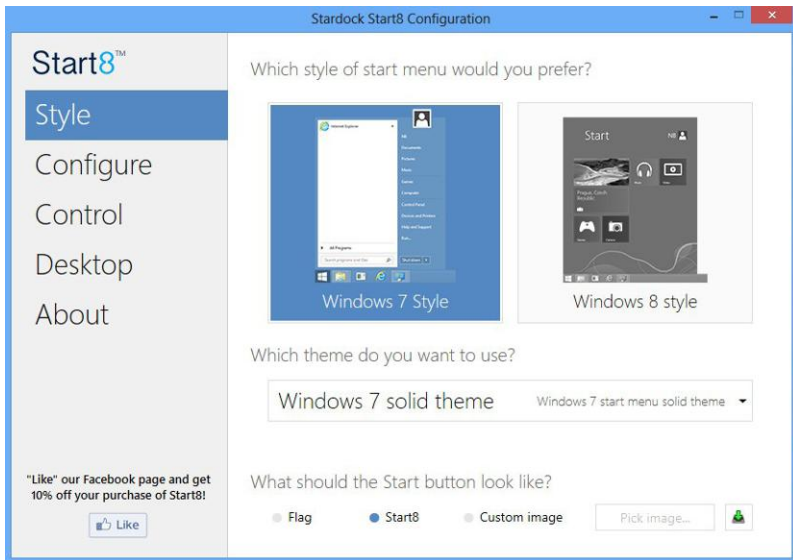

Select between the Windows 7 style and Windows 8 style Start Menu. Then select the theme of the Start Menu and customize the style of the Start icon.

Configure

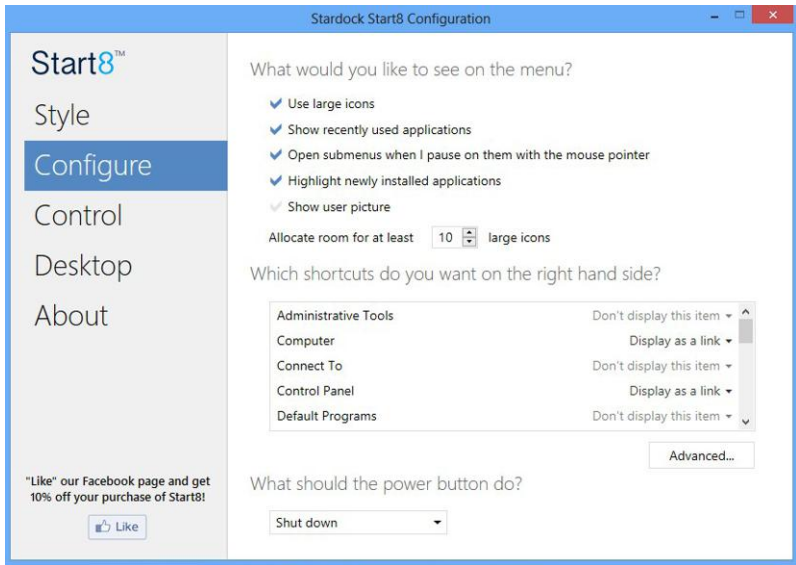

Configure provides configuration options, including icon sizes, which shortcuts you want Start Menu to display, quick access to recently used apps, the functionality of the power button, and more.

Control

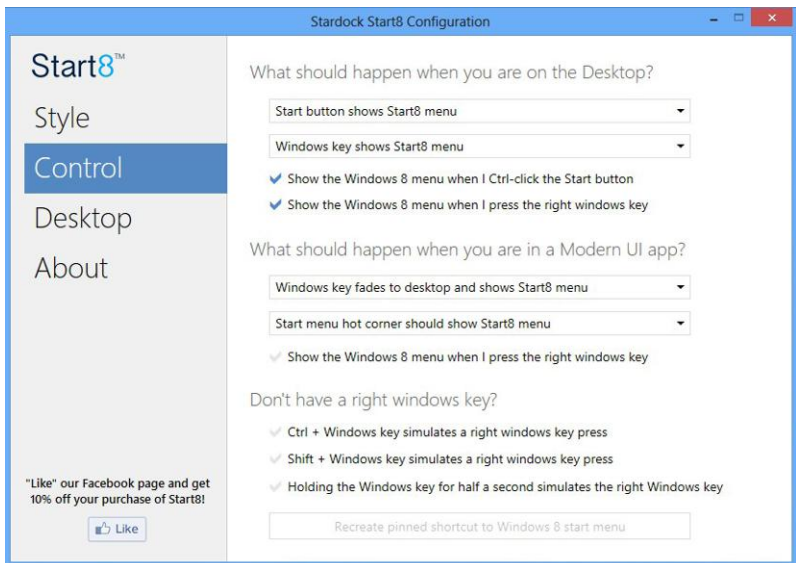

Control lets you configure what a click on the start button or a press on the Windows key does.

Desktop

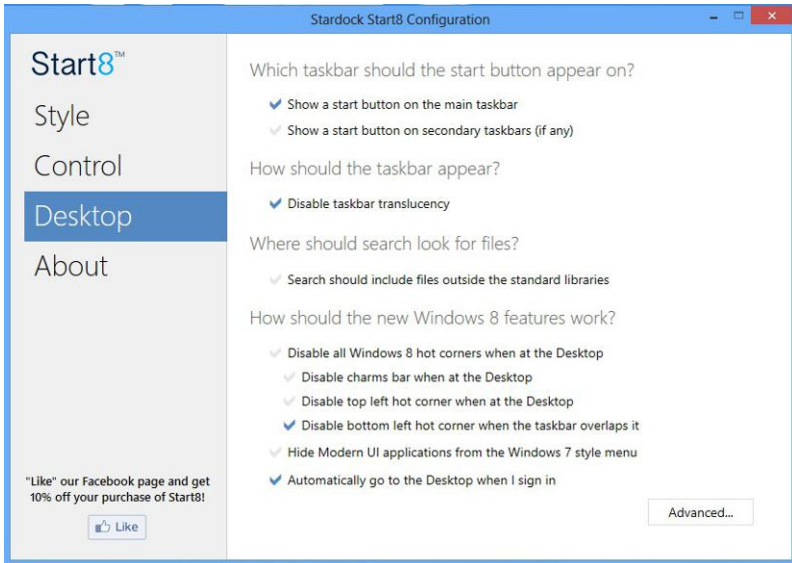

Desktop allows you to disable the hot corners when you are working on the desktop. It also lets you choose whether or not the system boots directly into desktop mode and bypass the Metro user interface.

About

Displays information about Start8.

Chapter 4 UEFI SETUP UTILITY

4.1 Introduction

This section explains how to use the UEFI SETUP UTILITY to configure your system. You may run the UEFI SETUP UTILITY by pressing <F2> or right after you power on the computer, otherwise, the Power-On-Self-Test (POST) will continue with its test routines. If you wish to enter the UEFI SETUP UTILITY after POST, restart the system by pressing <Ctl> + <Alt> + <Delete>, or by pressing the reset button on the system chassis. You may also restart by turning the system off and then back on.



Because the UEFI software is constantly being updated, the following UEFI setup screens and descriptions are for reference purpose only, and they may not exactly match what you see on your screen.

4.1.1 UEFI Menu Bar

The top of the screen has a menu bar with the following selections:

Main	For setting system time/date information
Advanced	For advanced system configurations
Tool	Useful tools
H/W Monitor	Displays current hardware status
Security	For security settings
Boot	For configuring boot settings and boot priority
Exit	Exit the current screen or the UEFI Setup Utility

4.1.2 Navigation Keys

Use <←> key or <→> key to choose among the selections on the menu bar, and use <↑> key or <↓> key to move the cursor up or down to select items, then press <Enter> to get into the sub screen. You can also use the mouse to click your required item.

Please check the following table for the descriptions of each navigation key.

Navigation Key(s)	Description
+ / -	To change option for the selected items
<Tab>	Switch to next function
<PGUP>	Go to the previous page
<PGDN>	Go to the next page
<HOME>	Go to the top of the screen
<END>	Go to the bottom of the screen
<F1>	To display the General Help Screen
<F4>	Toggle sound on/off
<F7>	Discard changes and exit the SETUP UTILITY
<F9>	Load optimal default values for all the settings
<F10>	Save changes and exit the SETUP UTILITY
<F12>	Print screen
<ESC>	Jump to the Exit Screen or exit the current screen

4.2 Main Screen

When you enter the UEFI SETUP UTILITY, the Main screen will appear and display the system overview.

Q1900M:



D1800M:



English

4.3 Advanced Screen

In this section, you may set the configurations for the following items:
 CPU Configuration, Chipset Configuration, Storage Configuration, Intel® Smart Connect Technology, Super IO Configuration, ACPI Configuration, USB Configuration and Trusted Computing.



Setting wrong values in this section may cause the system to malfunction.

4.3.1 CPU Configuration



Active Processor Cores

Select the number of cores to enable in each processor package.

Intel SpeedStep Technology

Intel SpeedStep technology allows processors to switch between multiple frequencies and voltage points for better power saving and heat dissipation.

CPU C States Support

Enable CPU C States Support for power saving. It is recommended to keep C3, C6 and C7 all enabled for better power saving.

Enhanced Halt State (C1E)

Enable Enhanced Halt State (C1E) for lower power consumption.

No-Execute Memory Protection

Processors with No-Execution Memory Protection Technology may prevent certain classes of malicious buffer overflow attacks.

Hardware Prefetcher

Automatically prefetch data and code for the processor. Enable for better performance.

Adjacent Cache Line Prefetch

Automatically prefetch the subsequent cache line while retrieving the currently requested cache line. Enable for better performance.

Intel Virtualization Technology

Intel Virtualization Technology allows a platform to run multiple operating systems and applications in independent partitions, so that one computer system can function as multiple virtual systems.

4.3.2 Chipset Configuration



DRAM Voltage

Use this to configure DRAM Voltage. The default value is [Auto].

Primary Graphics Adapter

Select a primary VGA.

Share Memory

Configure the size of memory that is allocated to the integrated graphics processor when the system boots up.

Onboard HD Audio

Enable/disable onboard HD audio. Set to Auto to enable onboard HD audio and automatically disable it when a sound card is installed.

Front Panel

Enable/disable front panel HD audio.

Onboard HDMI HD Audio

Enable audio for the onboard digital outputs.

Onboard LAN

Enable or disable the onboard network interface controller.

PCIe1 Link Speed

Select the link speed for PCIe1.

Deep S5

Configure deep sleep mode for power saving when the computer is shut down.

Restore on AC/Power Loss

Select the power state after a power failure. If [Power Off] is selected, the power will remain off when the power recovers. If [Power On] is selected, the system will start to boot up when the power recovers.

Good Night LED

By enabling Good Night LED, the Power/LAN LEDs will be switched off when the system is on. It will also automatically switch off the Power and LAN LEDs when the system enters into Standby/Hibernation mode.

4.3.3 Storage Configuration



SATA Controller(s)

Enable/disable the SATA controllers.

SATA Mode Selection

IDE: For better compatibility.

AHCI: Supports new features that improve performance.



AHCI (Advanced Host Controller Interface) supports NCQ and other new features that will improve SATA disk performance but IDE mode does not have these advantages.

SATA Aggressive Link Power Management

SATA Aggressive Link Power Management allows SATA devices to enter a low power state during periods of inactivity to save power. It is only supported by AHCI mode.

Hard Disk S.M.A.R.T.

S.M.A.R.T stands for Self-Monitoring, Analysis, and Reporting Technology. It is a monitoring system for computer hard disk drives to detect and report on various indicators of reliability.

4.3.4 Intel® Smart Connect Technology



Intel® Smart Connect Technology

Intel® Smart Connect Technology automatically updates your email and social networks, such as Twitter, Facebook, etc. while the computer is in sleep mode.

4.3.5 Super IO Configuration



Serial Port 1

Enable or disable the Serial port 1.

Serial Port Address

Select the address of the Serial port.

Parallel Port

Enable or disable the Parallel port.

Change Settings

Select the address of the Parallel port.

Device Mode

Select the device mode according to your connected device.

4.3.6 ACPI Configuration



Suspend to RAM

Select disable for ACPI suspend type S1. It is recommended to select auto for ACPI S3 power saving.

ACPI HPET Table

Enable the High Precision Event Timer for better performance and to pass WHQL tests.

PS/2 Keyboard Power On

Allow the system to be waked up by a PS/2 Keyboard.

PCIE Device Power On

Allow the system to be waked up by a PCIE device and enable wake on LAN.

Ring-In Power On

Allow the system to be waked up by onboard COM port modem Ring-In signals.

RTC Alarm Power On

Allow the system to be waked up by the real time clock alarm. Set it to By OS to let it be handled by your operating system.

USB Keyboard/Remote Power On

Allow the system to be waked up by an USB keyboard or remote controller.

USB Mouse Power On

Allow the system to be waked up by an USB mouse.

4.3.7 USB Configuration



USB Controller

Enable or disable all the USB ports.

USB 3.0 Controller

Enable or disable all the USB 3.0 ports.

Legacy USB Support

Enable or disable Legacy OS Support for USB 2.0 devices. If you encounter USB compatibility issues it is recommended to disable legacy USB support. Select UEFI Setup Only to support USB devices under the UEFI setup and Windows/Linux operating systems only.

4.3.8 Trusted Computing



Security Device Support

Enable to activate Trusted Platform Module (TPM) security for your hard disk drives.

4.4 Tools



Instant Flash

Save UEFI files in your USB storage device and run Instant Flash to update your UEFI.

Internet Flash

ASRock Internet Flash downloads and updates the latest UEFI firmware version from our servers for you. Please setup network configuration before using Internet Flash.

*For BIOS backup and recovery purpose, it is recommended to plug in your USB pen drive before using this function.

Network Configuration

Use this to configure internet connection settings for Internet Flash.



Internet Setting

Enable or disable sound effects in the setup utility.

UEFI Download Server

Select a server to download the UEFI firmware.

4.5 Hardware Health Event Monitoring Screen

This section allows you to monitor the status of the hardware on your system, including the parameters of the CPU temperature, motherboard temperature, fan speed and voltage.



CPU Fan 1 Setting

This allows you to set CPU fan 1's speed. Configuration options: [Full On] and [Automatic Mode]. The default value is [Full On].

Chassis Fan 1 Setting

This allows you to set chassis fan 1's speed. Configuration options: [Full On], [Automatic Mode] and [Manual]. The default value is [Full On].

Case Open Feature

Enable or disable Case Open Feature to detect whether the chassis cover has been removed.

4.6 Security Screen

In this section you may set or change the supervisor/user password for the system. You may also clear the user password.



Supervisor Password

Set or change the password for the administrator account. Only the administrator has authority to change the settings in the UEFI Setup Utility. Leave it blank and press enter to remove the password.

User Password

Set or change the password for the user account. Users are unable to change the settings in the UEFI Setup Utility. Leave it blank and press enter to remove the password.

Secure Boot

Enable to support Windows 8 Secure Boot.

4.7 Boot Screen

This section displays the available devices on your system for you to configure the boot settings and the boot priority.



Fast Boot

Fast Boot minimizes your computer's boot time. In fast mode you may not boot from an USB storage device. Ultra Fast mode is only supported by Windows 8 and the VBIOS must support UEFI GOP if you are using an external graphics card. Please notice that Ultra Fast mode will boot so fast that the only way to enter this UEFI Setup Utility is to Clear CMOS or run the Restart to UEFI utility in Windows.

Boot From Onboard LAN

Allow the system to be waked up by the onboard LAN.

Setup Prompt Timeout

Configure the number of seconds to wait for the setup hot key.

Bootup Num-Lock

Select whether Num Lock should be turned on or off when the system boots up.

Boot Beep

Select whether the Boot Beep should be turned on or off when the system boots up. Please note that a buzzer is needed.

Full Screen Logo

Enable to display the boot logo or disable to show normal POST messages.

AddOn ROM Display

Enable AddOn ROM Display to see the AddOn ROM messages or configure the AddOn ROM if you've enabled Full Screen Logo. Disable for faster boot speed.

CSM (Compatibility Support Module)



CSM

Enable to launch the Compatibility Support Module. Please do not disable unless you're running a WHCK test. If you are using Windows 8 64-bit and all of your devices support UEFI, you may also disable CSM for faster boot speed.

Launch PXE OpROM Policy

Select UEFI only to run those that support UEFI option ROM only. Select Legacy only to run those that support legacy option ROM only. Do not launch?

Launch Storage OpROM Policy

Select UEFI only to run those that support UEFI option ROM only. Select Legacy only to run those that support legacy option ROM only. Do not launch?

Launch Video OpROM Policy

Select UEFI only to run those that support UEFI option ROM only. Select Legacy only to run those that support legacy option ROM only. Do not launch?

4.8 Exit Screen



Save Changes and Exit

When you select this option the following message, “Save configuration changes and exit setup?” will pop out. Select [OK] to save changes and exit the UEFI SETUP UTILITY.

Discard Changes and Exit

When you select this option the following message, “Discard changes and exit setup?” will pop out. Select [OK] to exit the UEFI SETUP UTILITY without saving any changes.

Discard Changes

When you select this option the following message, “Discard changes?” will pop out. Select [OK] to discard all changes.

Load UEFI Defaults

Load UEFI default values for all options. The F9 key can be used for this operation.

Launch EFI Shell from filesystem device

Copy shellx64.efi to the root directory to launch EFI Shell.

Contact Information

If you need to contact ASRock or want to know more about ASRock, you're welcome to visit ASRock's website at <http://www.asrock.com>; or you may contact your dealer for further information. For technical questions, please submit a support request form at <http://www.asrock.com/support/tsd.asp>

ASRock Incorporation

2F., No.37, Sec. 2, Jhongyang S. Rd., Beitou District,

Taipei City 112, Taiwan (R.O.C.)

ASRock EUROPE B.V.

Bijsterhuizen 3151

6604 LV Wijchen

The Netherlands

Phone: +31-24-345-44-33

Fax: +31-24-345-44-38

ASRock America, Inc.

13848 Magnolia Ave, Chino, CA91710

U.S.A.

Phone: +1-909-590-8308

Fax: +1-909-590-1026