

ANAFI™

ANYTIME. ANYWHERE

USER GUIDE v2.6.2

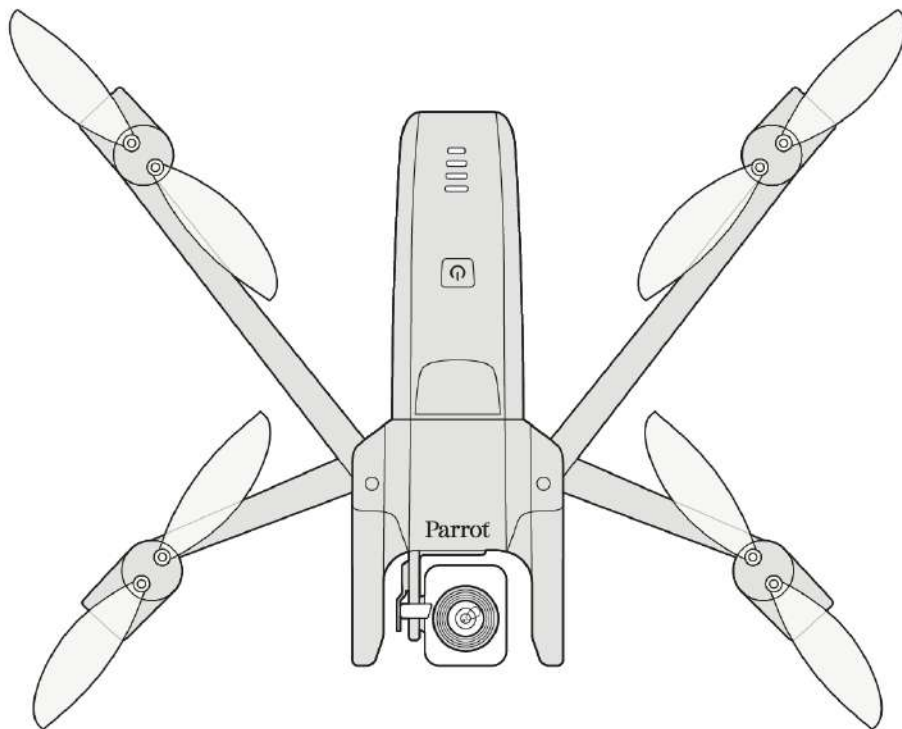

Parrot®

EVERYDAY LIFE. ELEVATED

WE ARE PARROT. WELCOME TO THE FAMILY!

With **ANAFI**, you have chosen the finest, quietest, and most portable flying 4K HDR camera, you can use everywhere on the go, anytime.

We strongly recommend you read the following information and instructions thoroughly before you get **ANAFI** in the air, to make the most of your first amazing 25-minute flight.

The indispensable prerequisites, on the next pages, will not occupy more than 5 minutes of your time: ANAFI requires the FreeFlight 6 app to fly, and to make sure your drone and controller are fully up-to-date with the latest features.

As you discover the world of possibilities that **ANAFI** opens to you, you will find out that carefully planning your flights is exciting, and only adds to the fun of flying them.

Have a great read, and many outstanding hours flying **ANAFI**!

USING THIS GUIDE

- **Read entirely at least once:** it answers most questions that most users encounter when they discover **ANAFI**.
- **Keep it for reference and stay alert for updates:** they will be advertised on all Parrot websites and social media.
- **The Table of contents, on page 7, is active.** Click a title to access the corresponding section.
- **This online user guide has no index:** use [ctrl]-F (Windows) or [command]-F (Mac) to browse all occurrences of any keyword (*flight, preferences, gimbal, Android, iPhone, photo, EV, ISO*, and so on).

PREREQUISITES

You want ANAFI up in the air as soon as possible, so do we. Refer to the enclosed Super Quick Start Guide (SQSG) if you need illustrated guidance to get these quick prerequisites out of the way.

1. **Wake your ANAFI's smart battery up.** Charge the battery using the enclosed USB-A to USB-C cable and a USB-A power adapter (not included in the box). The battery's LEDs start flashing; it is awake. Let it charge while you read. **Parrot recommends you always run a full charge of your smart battery before flying ANAFI.**
2. **Download FreeFlight 6 on your iOS or Android smartphone: ANAFI requires FreeFlight 6 to fly.** The app will enable you to update your **Parrot Skycontroller 3** and **ANAFI** when you power them on for the first time.



Android FreeFlight 6 QR code



iOS FreeFlight 6 QR code

When you have downloaded and installed **FreeFlight 6**, unfold the central arm of **Parrot Skycontroller 3** to power it on.

Use your device's USB cable to connect it to **Parrot Skycontroller 3** USB-A port, and install it on the device holder, as shown in the enclosed SQSG.

A prompt appears on your screen, which invites you to allow the communication between your device and the controller.

Tap "Allow" (iOS) or "OK" (Android); **FreeFlight 6** runs. After your device displays the app's splash screen, you get to **FreeFlight 6** homepage.

If the prompt does not appear on your screen when you connect your device to your *Parrot Skycontroller 3*, launch *FreeFlight 6* manually, as any other app.

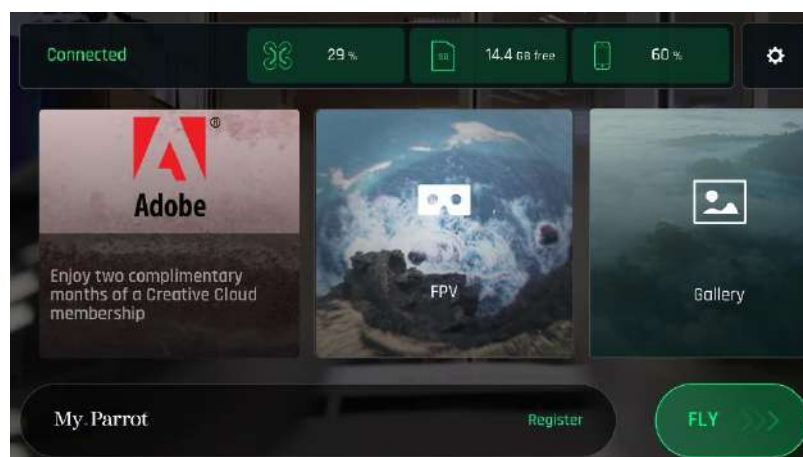

iOS FreeFlight 6 homepage

3. Tap the green "FLY" box on the homepage of FreeFlight 6 to launch the initial updates. FreeFlight 6 automatically updates the Parrot Skycontroller 3 first, and ANAFI second.

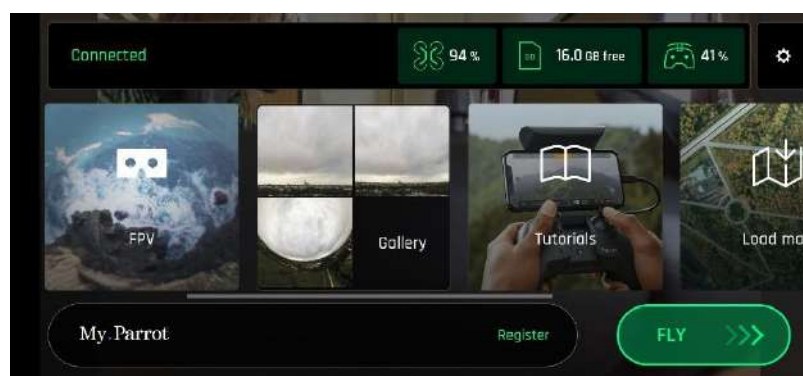

Android FreeFlight 6 homepage

4. Parrot Skycontroller 3 update: tap the green "CONTINUE" box to proceed. FreeFlight 6 displays an animation and a progress circle on a screen labelled "Preparing your controller". When the update is finished, the screen displays "Your controller is ready". Tap "CONTINUE" to access the update of ANAFI (screenshots below are Android).

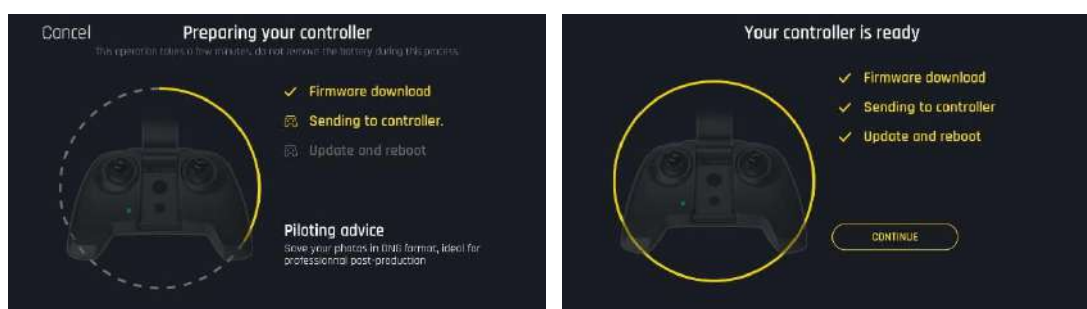

ANAFI

5. **ANAFI update: tap the green "CONTINUE" box to proceed.** FreeFlight 6 displays an animation and a progress circle on a screen labelled "Preparing your drone". When the update is finished, the screen displays "Your drone is ready" and a "CONTINUE" box. Tap this "CONTINUE" box to come back to **FreeFlight 6** homepage (screenshots below are iOS).

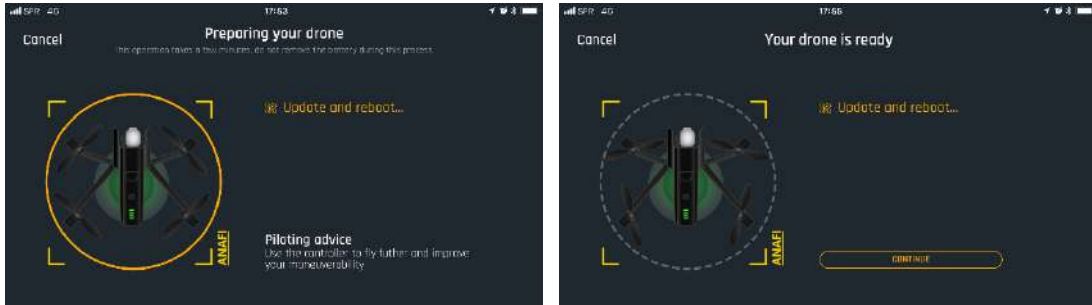

6. All systems are ready for flight!

TABLE OF CONTENTS

WE ARE PARROT. WELCOME TO THE FAMILY!	3
USING THIS GUIDE.....	3
PREREQUISITES	4
TABLE OF CONTENTS.....	7
FOREWORD.....	11
About ANAFI.....	11
About Wi-Fi	11
About 4K video formats.....	11
About the smart battery	11
About auto-RTH (return home)	11
About devices.....	12
About My.Parrot accounts.....	12
DISCLAIMER.....	13
TECHNICAL SPECIFICATIONS – ANAFI & ANAFI Extended	14
PACKAGE CONTENTS – ANAFI	15
PACKAGE CONTENTS – ANAFI Extended	16
TECHNICAL SPECIFICATIONS – ANAFI FPV	17
PACKAGE CONTENTS – ANAFI FPV	18
PRESENTATION OF ANAFI	19
Ready to store or carry.....	19
Ready to fly.....	19
PRESENTATION OF PARROT SKYCONTROLLER 3	20
Ready to store or carry.....	20
Ready to pilot	20
Camera and gimbal controls.....	21
LED status indicator color codes.....	21

ANAFI

PRESENTATION OF PARROT COCKPITGLASSES 3	22
PRE-FLIGHT CHECKLIST.....	24
Equipment.....	24
Regulations.....	24
Flight conditions	24
GETTING STARTED.....	25
TAKING OFF.....	26
Ground take-off.....	26
Hand launch	26
FLYING	27
RETURNING HOME	28
Precise Home Setting	28
SMART RTH.....	28
LANDING.....	29
Hand landing.....	29
SMART LIPO BATTERY.....	30
Battery removal.....	30
Battery installation.....	31
Battery charging	31
Battery care and safety.....	32
MEDIA RETRIEVAL	34
Extracting the microSD card	34
Retrieving photos and videos	34
Installing the microSD card.....	34
Compatible microSD cards.....	35
Direct media retrieval (drone to computer)	35
FreeFlight 6 Gallery	35
INTRODUCING FREEFLIGHT 6	36
Presentation of the iOS HUD (video mode view)	37
Presentation of the Android HUD (photo mode view)	39

PREFERENCES.....	40
Controls.....	40
Presets.....	40
Interface.....	41
Safety.....	41
Camera.....	42
Network.....	42
VIDEOS AND PHOTOS.....	43
Making videos.....	43
Taking photos.....	45
Creating Panoramas.....	48
GIMBAL TILT AND ZOOM CONTROLS.....	52
Gimbal tilt control.....	52
Zoom control.....	52
Camera Calibration: Correct horizon (exceptional procedure).....	55
Camera Calibration: Gimbal calibration.....	57
PRO-IMAGING SETTINGS.....	58
Exposure value (EV).....	58
Shutter speed (s).....	58
ISO value (ISO).....	59
White balance (WB).....	59
HDR.....	60
NATURAL Style.....	61
P-LOG Style.....	61
INTENSE Style.....	61
PASTEL Style.....	62
ADJUSTMENT.....	62
Lock AE.....	63
Lock AE Touch.....	64

CINESHOTS	65
360°	65
Reveal	65
Spiral.....	66
Epic.....	66
CONTROL	67
Classic.....	67
Arcade.....	67
PILOTING MODES	69
Manual flight.....	69
Cameraman	69
Follow Me (in-app purchase).....	70
Smartdronies	72
FPV FLYING MODE	73
FPV presentation and activation	73
FPV HUD	75
See-through FPV view	76
FPV settings.....	77
Interface settings	78
Camera settings	78
Equipment setting	78
MAP-BASED FLYING MODES.....	79
Flight Plan (in-app purchase).....	79
Touch & Fly: Waypoint	85
Touch & Fly: POI.....	85

FOREWORD

About ANAFI

ANAFI was designed and optimized to fly as is. Parrot therefore strongly discourages the use of any add-on or accessory which could be mounted on, or attached to ANAFI (motor covers, feet extensions, buoys, hulls, etc.). In addition to the overweight they carry for the drone and its motors, they can indeed magnetically disturb ANAFI and impair its communications.

ND filters, however, are not affected by this warning: filters can be used on ANAFI's lens, but Parrot recommends installing them carefully, after the drone's gimbal initialization.

About Wi-Fi

Parrot asks you to switch off your smartphone's Wi-Fi connection when flying ANAFI with both the Parrot Skycontroller 3 and your phone: with this configuration, the drone and the controller communicate through ANAFI's Wi-Fi network and activating your phone's Wi-Fi can only result in interferences.

Therefore, your phone's Wi-Fi should **only** be activated - and connected to ANAFI's Wi-Fi network - when you want to fly the drone using your smartphone as its sole controller.

About 4K video formats

4K video formats are professional grade media which may not be read natively by slower computers. Shoot in 1080p or use a video converter to turn your ANAFI's 4K videos into a more manageable format (like 1080p) if they do not read properly on your equipment. This is especially true for Parrot's 4K Cinema format, which can only be handled by professional editing equipment.

About the smart battery

ANAFI's smart battery is preinstalled on your drone. Always install it the same way and never attempt to install it upside down as it could expose your battery and your drone to **irrecoverable electrical damage**. As you will find out by reading this guide, ANAFI's battery is smart enough to enter a wintering mode when you are not using it for ten days in a row. This also means you need to wake it up and charge it completely before you fly ANAFI for the first time.

About auto-RTH (return home)

By design, when synchronized to GPS and Glonass satellites and when short on power, ANAFI will always attempt to come back to its most recent take-off point, at minimal height

ANAFI

over this take-off point, which is configurable through **FreeFlight 6** (between 20 meters and 100 meters) and is set by default at 30 meters.

For this reason, Parrot recommends ANAFI pilots to take extra care when moving away from the take-off location of their drone (for example to follow ANAFI). In such cases, pilots must cancel the auto-RTH from the orange 1-minute alert which appears on the screen of their device, and keep piloting ANAFI while monitoring closely its battery level, until it runs out of power and lands.

About devices

In the following pages, the word "*device*" refers to the smartphone, either iOS or Android-based, on which **FreeFlight 6** is installed.

About My.Parrot accounts

Parrot strongly recommends that you use your My.Parrot account (or create one if **ANAFI** is your first Parrot drone) to let Parrot store your **ANAFI** flight data. Sharing your data, even anonymously, benefits the community, as it enables us to improve our products. It also directly benefits all identifiable users in case they need to contact Parrot support teams.

DISCLAIMER

1. **ANAFI** IS NOT A TOY and should not be used or handled by a person under the age of 14 years.
2. BEFORE USING **ANAFI**:
 - (A) CAREFULLY READ the user manual and all information and documentation available on www.parrot.com, which is susceptible to be updated at any time and without prior notice (hereinafter referred to as "Parrot Documentation"). SPECIAL ATTENTION must be given to the paragraphs marked with the symbol  ;
 - (B) ENSURE YOU ARE AWARE OF THE REGULATIONS APPLICABLE TO THE USE OF DRONES AND THEIR ACCESSORIES (hereinafter referred to as "Applicable Regulations");
 - (C) REMEMBER that **ANAFI** may expose others and yourself to EQUIPMENT DAMAGE, PERSONAL INJURY, OR BOTH, which could result in serious harm or death.
3. Be aware that videos and photos that are promoted and advertised by Parrot Drones SAS and its affiliates have been made by and with experienced professionals and drone pilots. IN CASE OF DOUBT RELATING TO THE USE OF YOUR **ANAFI** DRONE AND ITS ACCESSORIES, ALWAYS REFER TO THE MOST RECENT VERSION OF THE PARROT DOCUMENTATION.
4. TO THE EXTENT PERMITTED BY APPLICABLE LAW, PARROT DRONES SAS, ITS SUBSIDIARIES, AND THEIR RESPECTIVE DISTRIBUTORS AND RETAILERS SHALL NOT BE LIABLE FOR ANY DAMAGES ARISING FROM, OR IN CONNECTION WITH THE NON-COMPLIANCE OF PARROT WITH THE DOCUMENTATION OR THE APPLICABLE REGULATIONS BY YOURSELF OR ANY PERSON USING YOUR **ANAFI**.

TECHNICAL SPECIFICATIONS – ANAFI & ANAFI Extended

DRONE

- Size folded: 244x67x65mm
- Size unfolded: 175x240x65mm
- Weight: 320g
- Max transmission range: 4km with Skycontroller 3
- Max flight time: 25min
- Max horizontal speed: 55km/h
- Max vertical speed: 4m/s
- Max wind resistance: 50km/h
- Service ceiling: 4,500m above sea level
- Operating temperature range: -10°C to 40°C

DRONE SENSORS

- Satellite Positioning: GPS and Glonass
- Barometer & magnetometer
- Vertical camera & ultrasound sensor
- 2x6-axis IMUs (1 for the flight, 1 for the camera):
 - 2x3-axis accelerometers
 - 2x3-axis gyroscopes

SMART BATTERY

- Type: High density LiPo (2 cells)
- Capacity: 2,700mAh
- Flight time per charge: 25min
- Charging port: USB-C
- Weight: 126g
- Voltage: 7.6V
- Max charging power: 24W

PARROT SKYCONTROLLER 3

- Size folded: 94x152x72mm
- Size unfolded: 153x152x116mm
- Weight: 386g
- Transmission system: Wi-Fi 802.11a/b/g/n
- Operating frequencies: 2.4GHz – 5.8GHz
- Max transmission range: 4km
- Live streaming resolution: 720p (HD) 1280x720
- Battery capacity: 2,500mAh 3.6V
- Supported mobile devices: screen size up to 6.2"
- USB ports: USB-C (charge), USB-A (connection)

IMAGING SYSTEM

- Sensor: 1/2.4" CMOS
- LD-ASPH (low dispersion aspherical) lens:
 - Aperture: f/2.4
 - 35mm format equ. focal length: 23mm
 - Depth of field: 1.5m to ∞
- Electronic shutter speed: 1 to 1/10000s
- ISO range: 100 to 3200
- Video resolutions:
 - DCI 4K (cinema) 4096x2160 24fps
 - 2160p (4K UHD) 3840x2160 24/25/30fps
 - 1520p (2.7K) 2704x1520 24/25/30fps
 - 1080p (FHD) 1920x1080 24/25/30/48/50/60fps
 - 720p (HD) 1280x720 96/100/120fps
- Video horizontal field of view (HFOV): 69°
- Max video bitrate: 100Mbps
- Video format: MP4 (H.264)
- Digital zoom:
 - Lossless: up to x2.8 (FHD), up to x1.9 (2.7K), up to x1.4 (4K UHD)
 - Standard: up to x3 (all resolutions)
- HDR: 4K UHD, 2.7K and 1080p videos, JPEG photos
- Photo resolutions:
 - Wide (JPEG & DNG): 21MP (5344x4016) / 4:3 / 84° HFOV
 - Rectilinear (JPEG): 16MP (4608x3456) / 4:3 / 75.5° HFOV
- Photo modes:
 - Single, Burst, Bracketing, Timer and Panorama (5 formats)

IMAGE STABILIZATION

- 3-axis hybrid stabilization:
 - Mechanical: 2-axis (roll & pitch)
 - Electronic (EIS): 3-axis (roll, pitch & yaw)
- Controllable tilt range: -90° to +90° (nadir to zenith)

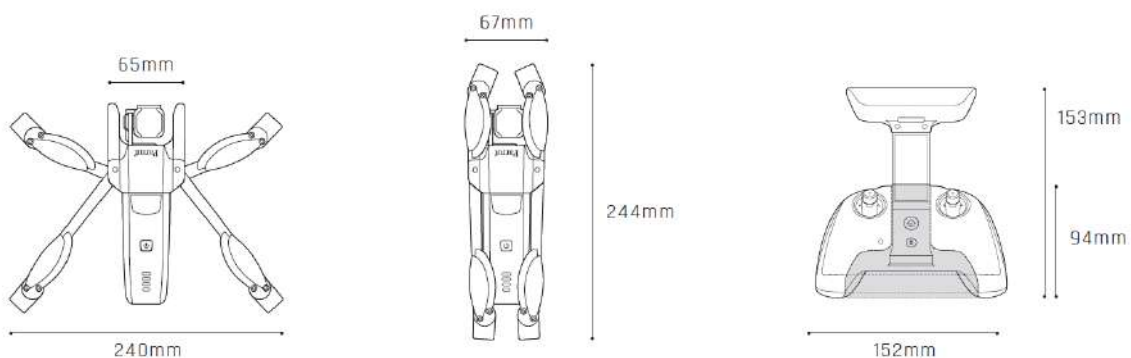

PACKAGE CONTENTS – ANAFI

Your **ANAFI** package contains:

- an **ANAFI** drone
- a smart battery, preinstalled on **ANAFI**
- a carrying case
- a lens cap
- a USB-A to USB-C charging cable
- a 16GB microSD card, preinstalled in **ANAFI**
- a microSD to SD card adapter
- a **Parrot Skycontroller 3**
- 8 spare propeller blades
- a mounting tool
- a Flight Safety Guide
- a Super Quick Start Guide (SQSG)
- a Wi-Fi settings card



ANAFI

PACKAGE CONTENTS – ANAFI Extended

Your **ANAFI Extended** package contains:

- an **ANAFI** drone
- a smart battery, preinstalled on **ANAFI**
- 2 additional batteries
- a shoulder bag
- a lens cap
- 3 USB-A to USB-C charging cables
- a 16GB microSD card, preinstalled in **ANAFI**
- a microSD to SD card adapter
- a **Parrot Skycontroller 3**
- 8 spare propeller blades
- a mounting tool
- a Flight Safety Guide
- a Super Quick Start Guide (SQSG)
- a Wi-Fi settings card



TECHNICAL SPECIFICATIONS – ANAFI FPV

DRONE

- Size folded: 218x69x64mm
- Size unfolded: 241x315x64mm
- Weight: 315g
- Max transmission range: 4km with Skycontroller 3
- Max flight time: 25min
- Max horizontal speed: 55km/h
- Max vertical speed: 4m/s
- Max wind resistance: 50km/h
- Service ceiling: 4,500m above sea level
- Operating temperature range: -10°C to 40°C

DRONE SENSORS

- Satellite Positioning: GPS and Glonass
- Barometer & magnetometer
- Vertical camera & ultrasound sensor
- 2x6-axis IMUs (1 for the flight, 1 for the camera):
 - 2x3-axis accelerometers
 - 2x3-axis gyroscopes

SMART BATTERY

- Type: High density LiPo (2 cells)
- Capacity: 2,700mAh
- Flight time per charge: 25min
- Charging port: USB-C
- Weight: 126g
- Voltage: 7.6V
- Max charging power: 24W

PARROT SKYCONTROLLER 3

- Size folded: 94x152x72mm
- Size unfolded: 153x152x116mm
- Weight: 386g
- Transmission system: Wi-Fi 802.11a/b/g/n
- Operating frequencies: 2.4GHz – 5.8GHz
- Max transmission range: 4km
- Live streaming resolution: 720p (HD) 1280x720
- Battery capacity: 2,500mAh 3.6V
- Supported mobile devices: screen size up to 6.2"
- USB ports: USB-C (charge), USB-A (connection)

IMAGING SYSTEM

- Sensor: 1/2.4" CMOS
- LD-ASPH (low dispersion aspherical) lens:
 - Aperture: f/2.4
 - 35mm format equ. focal length: 23mm
 - Depth of field: 1.5m to ∞
- Electronic shutter speed: 1 to 1/10000s
- ISO range: 100 to 3200
- Video resolutions:
 - DCI 4K (cinema) 4096x2160 24fps
 - 2160p (4K UHD) 3840x2160 24/25/30fps
 - 1520p (2.7K) 2704x1520 24/25/30fps
 - 1080p (FHD) 1920x1080 24/25/30/48/50/60fps
 - 720p (HD) 1280x720 96/100/120fps
- Video horizontal field of view (HFOV): 69°
- Max video bitrate: 100Mbps
- Video format: MP4 (H.264)
- Digital zoom:
 - Lossless: up to x2.8 (FHD), up to x1.9 (2.7K), up to x1.4 (4K UHD)
 - Standard: up to x3 (all resolutions)
- HDR: 4K UHD, 2.7K and 1080p videos, JPEG photos
- Photo resolutions:
 - Wide (JPEG & DNG): 21MP (5344x4016) / 4:3 / 84° HFOV
 - Rectilinear (JPEG): 16MP (4608x3456) / 4:3 / 75.5° HFOV
- Photo modes:
 - Single, Burst, Bracketing, Timer and Panorama (5 formats)

IMAGE STABILIZATION

- 3-axis hybrid stabilization:
 - Mechanical: 2-axis (roll & pitch)
 - Electronic (EIS): 3-axis (roll, pitch & yaw)
- Controllable tilt range: -90° to +90° (nadir to zenith)

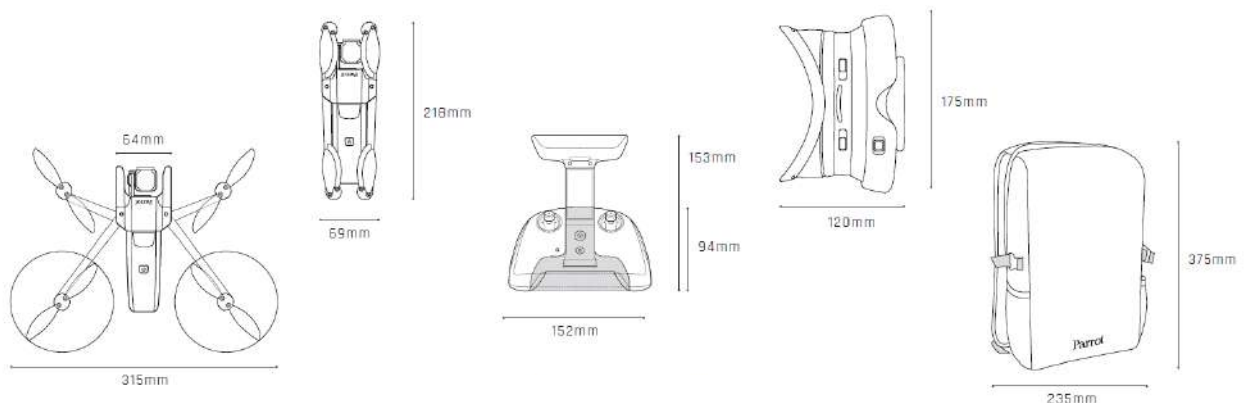

PACKAGE CONTENTS – ANAFI FPV

Your **ANAFI FPV** package contains:

- an **ANAFI** drone
- a smart battery, preinstalled on **ANAFI**
- a backpack
- a lens cap
- a USB-A to USB-C charging cable
- a 16GB microSD card, preinstalled in **ANAFI**
- a microSD to SD card adapter
- a **Parrot Skycontroller 3**
- a set of **Parrot Cockpitglasses 3**
- 8 spare propeller blades
- a mounting tool
- a Flight Safety Guide
- a Super Quick Start Guide (SQSG)



PRESENTATION OF ANAFI

Ready to store or carry

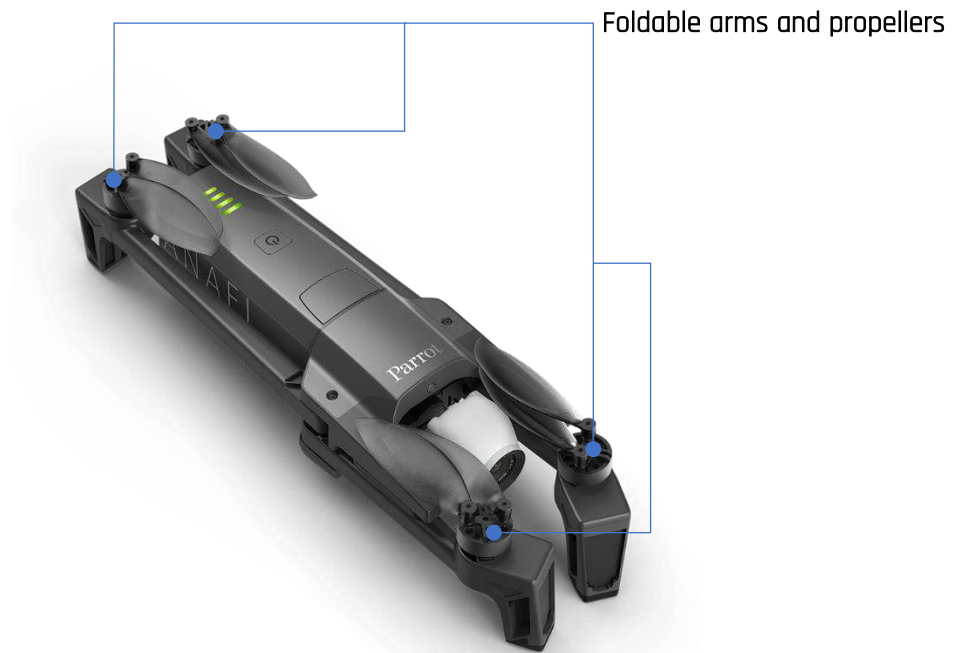

Ready to fly



PRESENTATION OF PARROT SKYCONTROLLER 3

Ready to store or carry

Left control stick

Right control stick



Power-on foldable arm and device holder

Ready to pilot

LED status indicator

Wi-Fi antenna



RTH (return home) button

Take-off/landing button

Camera and gimbal controls

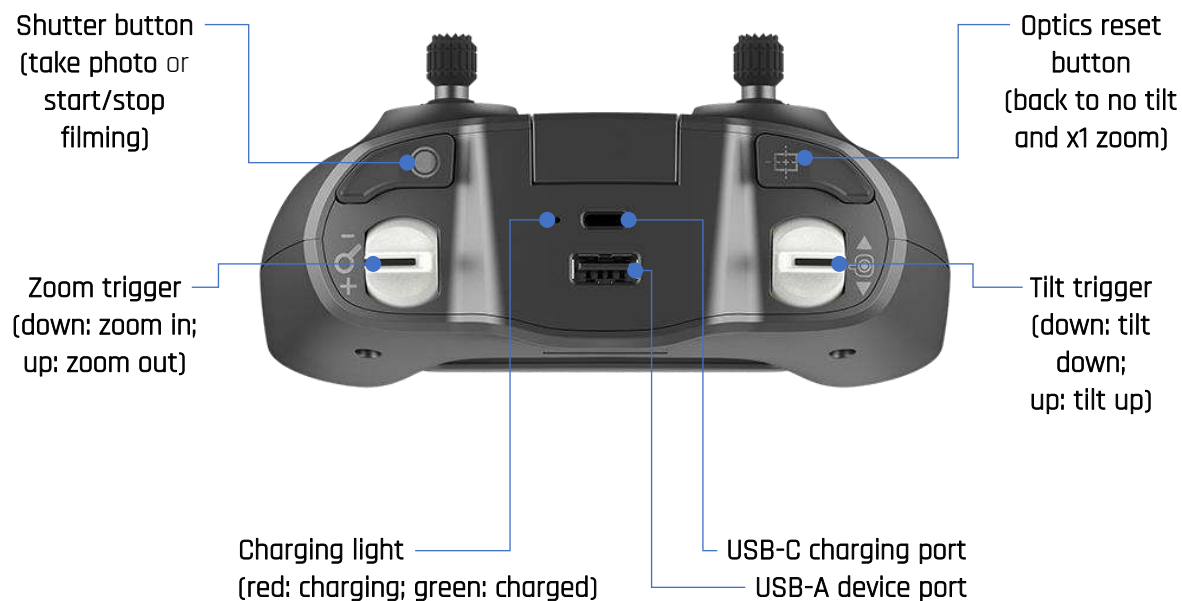

LED status indicator color codes

When the **Parrot Skycontroller 3** is powered on, its LED status indicator gives you an instant visual indication:

flashing green:
 alternating light blue and dark blue:
 flashing light blue:
 steady dark blue:
 alternating purple and dark blue:
 alternating red and any other color:

Skycontroller 3 update in progress;
 connecting to **ANAFI**;
 no drone configured or wrong WPA key;
 connected to **ANAFI**;
 autonomous flight in progress;
 low battery alert (**ANAFI**, **Skycontroller 3**,
 or both) or RTH alert.

PRESENTATION OF PARROT COCKPITGLASSES 3

⚠ Note that **Parrot Cockpitglasses 3** fit all devices up to 6.5".

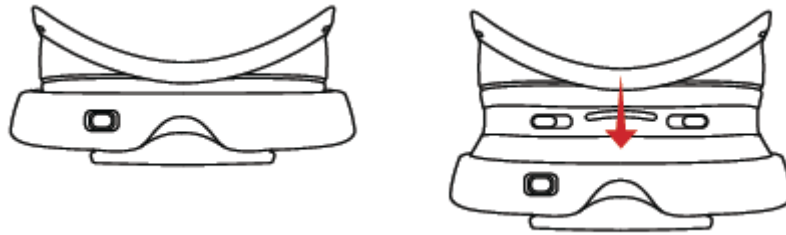

Parrot Cockpitglasses 3: unfold to fly

1. Connect your device to the **Parrot Skycontroller 3**.
2. Launch FPV mode by taping the FPV box.
3. Unfold the **Parrot Cockpitglasses 3**.
4. Open the Parrot branded flap at the front of the **Parrot Cockpitglasses 3**.
5. Carefully position your device in the center of the **Parrot Cockpitglasses 3**, using the split screen white line as reference; make sure your device is perfectly centered, and perfectly straight to ensure yourself an optimal viewing comfort.

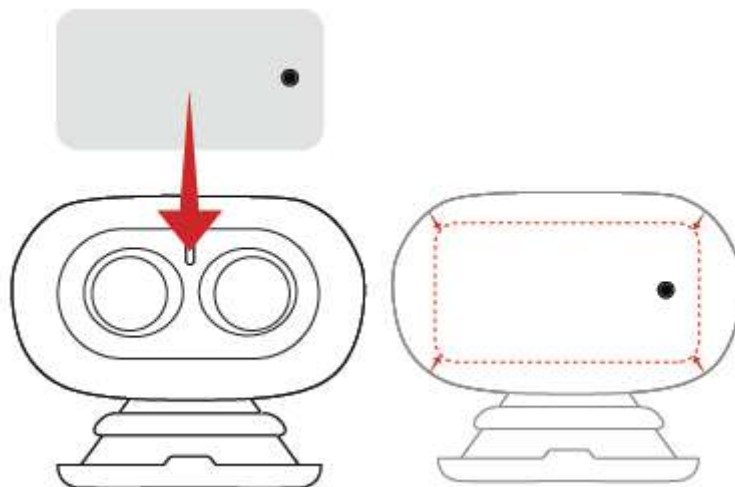

6. Close the flap and use the sliders located above your eyes to adjust the distance between the lenses to your view, as in the following diagram.

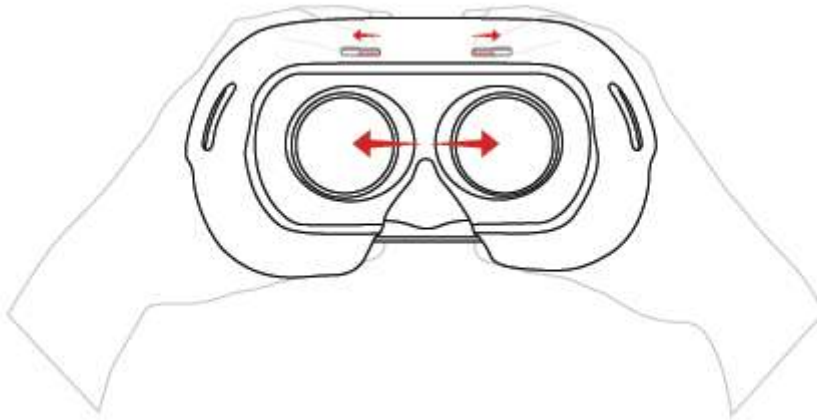

7. Adjust the straps of the **Parrot Cockpitglasses 3** to your head to ensure a safe flying session.

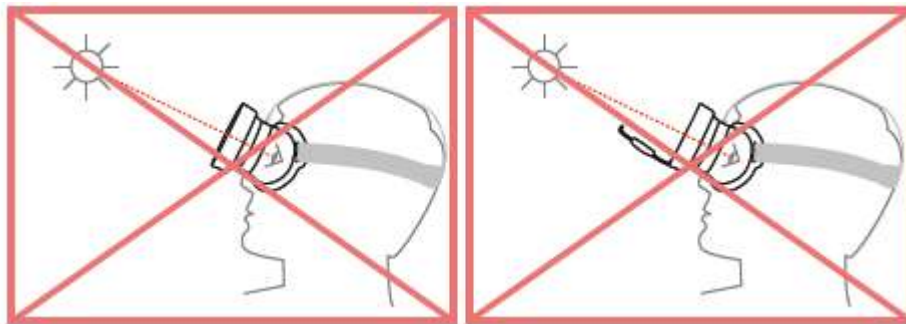

WARNING: NEVER POINT YOUR **PARROT COCKPITGLASSES 3** DIRECTLY TOWARD THE SUN OR ANY OTHER LIGHT SOURCES, AS SUN RAYS OR OTHER POWERFUL LIGHT SOURCES COULD CAUSE EQUIPMENT DAMAGE, PERSONAL OCULAR INJURY, OR BOTH.

PRE-FLIGHT CHECKLIST

Equipment

- ⚠ Make sure you have downloaded the latest version of FreeFlight 6 and that both your Parrot Skycontroller 3 and your ANAFI have been updated with the latest versions of firmware.
- ⚠ For the ultimate ANAFI experience, make sure you have the right USB-A cable to connect your Parrot Skycontroller 3 and your device.
- ⚠ Make sure ANAFI is fitted with a microSD card with enough free memory space.
- ⚠ Make sure all four foldable arms of ANAFI are unfolded.
- ⚠ Make sure its propellers are clean, intact and unobstructed.
- ⚠ Make sure both ANAFI's and Parrot Skycontroller 3's batteries are fully charged.
- ⚠ Make sure ANAFI's battery is securely installed on the drone's body.
- ⚠ Make sure the lens cap has been removed from ANAFI's camera.
- ⚠ Make sure ANAFI's lens is clean - if you need to clean it, hold the gimbal between two fingers so that you do not pressure its mechanism when you clean the lens, and gently wipe the lens with a microfiber cloth.

Regulations

- ⚠ Make sure the use of ANAFI is allowed where you are intending to fly.
- ⚠ Check for potential restrictions regarding the use of Wi-Fi frequencies in the area where you are intending to fly.

Flight conditions

- ⚠ Check that your flying zone is safe and clear.
- ⚠ Do not fly ANAFI at night.
- ⚠ Do not fly ANAFI over urban areas or over restricted airspaces such as airports, train stations, power plants, national reserves, and so on.
- ⚠ Check the weather: do not fly ANAFI in the rain, fog, snow, or in a wind exceeding 14 meters per second or 50 km/h.
- ⚠ Due to the operating mode of its vertical camera and ultrasound sensor, Parrot recommends you do not fly ANAFI over water and other reflective surfaces (mirrors, glass, and so on).

GETTING STARTED

1. Charge the battery using the enclosed USB-A to USB-C cable and a USB-A power adapter (not included in the box). Charging times depend on the supply capacity of the adapter. Refer to the *"Battery charging"* section of this guide for additional information. **Parrot recommends you always run a full charge of your smart battery before flying ANAFI.**
2. If you want to use the controller and enjoy the full **ANAFI** experience, charge **Parrot Skycontroller 3**.
3. Check that your flying zone is safe and clear.
4. To start the drone, place it on a flat horizontal surface and press the power button.
5. **a) If you use Parrot Skycontroller 3**, unfold the central part of the controller to power it on, wait for the steady dark blue light, then plug your device to the controller using a USB cable. **Parrot recommends you always fly ANAFI with Parrot Skycontroller 3 and a device, for the best flight experience.**
b) If you do not wish to use the controller, connect your device to the Wi-Fi network of **ANAFI**, using the Wi-Fi settings card located inside the drone's carrying case, shoulder bag or backpack - SSID format: Anafi-xxxxx.
6. **FreeFlight 6** runs automatically on your device and connects to **ANAFI** and to **Parrot Skycontroller 3**.
7. Check for controller and drone software updates.
8. Calibrate your **ANAFI**, your **Parrot Skycontroller 3**, or both, if required, following the instructions on the screen of your device.
9. Check that your flying zone is still safe and clear, and that no one (people, animal) has approached or is approaching **ANAFI**.
10. Stay at least 2m (6ft) clear from the drone, press the  button and enjoy the flight!

TAKING OFF

Ground take-off

Position **ANAFI** on a flat, even, and clear surface.

Power it on, move at least 2m (6ft) away from **ANAFI** and check that the surroundings of the drone are absolutely clear.

Press the  button on your **Parrot Skycontroller 3**, or tap the green "TAKE-OFF" box, on the screen of your device.

ANAFI takes off and stabilizes at 1m (3ft) from the ground, waiting for commands from the pilot.

Hand launch

- ⚠ Be especially careful when you hand launch **ANAFI**. This procedure is safe provided you are not distracted or startled by an outside event with a live drone in your hand: concentrate on what you are doing, but always stay aware of your surroundings.

Upon first opening of **FreeFlight 6**, from version 6.2, a hand launch tutorial reminds you the following procedure. You can activate hand launch from this tutorial page.

You can also activate the hand launch option from the "Interface" menu of **FreeFlight 6** Preferences (refer to the "PREFERENCES - Interface" section of this guide for further information).

Power **ANAFI** on and position the drone on your flat, open hand. On the screen of your device, the green "TAKE-OFF" box is replaced by a blue "HAND LAUNCH" box.

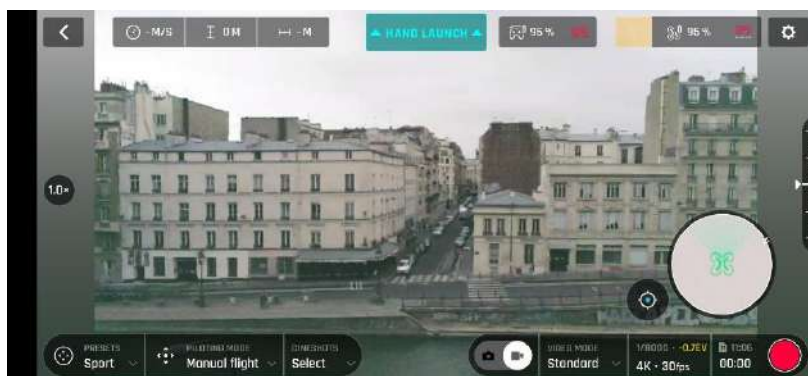









Android "Hand Launch" Screen

Press the  button on your **Parrot Skycontroller 3**, or tap the blue "HAND LAUNCH" box on the screen of your device. The drone's blades start rotating slowly and the screen of your device displays a hand-launch animation.

Briefly and briskly lift ANAFI up and forward with your open hand. ANAFI is airborne. It stabilizes, waiting for commands from the pilot.



FLYING

Left control stick (default mode)	Right control stick (default mode)
 <p>Rise</p>	 <p>Forward</p>
 <p>Descend</p>	 <p>Reverse</p>
 <p>Turn right</p>	 <p>Move to the right</p>
 <p>Turn left</p>	 <p>Move to the left</p>

⚠ Note that you can modify ANAFI's controls through the PREFERENCES menu of FreeFlight 6. Refer to the "*PREFERENCES / Controls*" section of this guide for additional information.

⚠ ANAFI's controls can also be set in Arcade mode. Refer to the "*CONTROL / Arcade*" section of this guide for additional information.

RETURNING HOME

To bring **ANAFI** back to its take-off position, press the  button on your **Parrot Skycontroller 3**, or tap the  icon on the screen of your device.

ANAFI rises to 30 meters over its take-off point - or to the altitude you have set, through **FreeFlight 6**, between 20 and 100 meters - and flies back over its take-off position.

Refer to the *“PREFERENCES - Safety”* section of this guide for instructions on RTH height configuration.

In the Follow Me mode (in-app purchase), when the  button or icon is activated, **ANAFI** flies back to the position of the pilot.

Precise Home Setting

When flight conditions are optimal at take-off, **ANAFI** can set a “precise home” for itself, through its vertical camera. In that case, a pop-up on the screen of **FreeFlight 6** confirms a precise home has been set, and the home icon of the mini-map turns green.

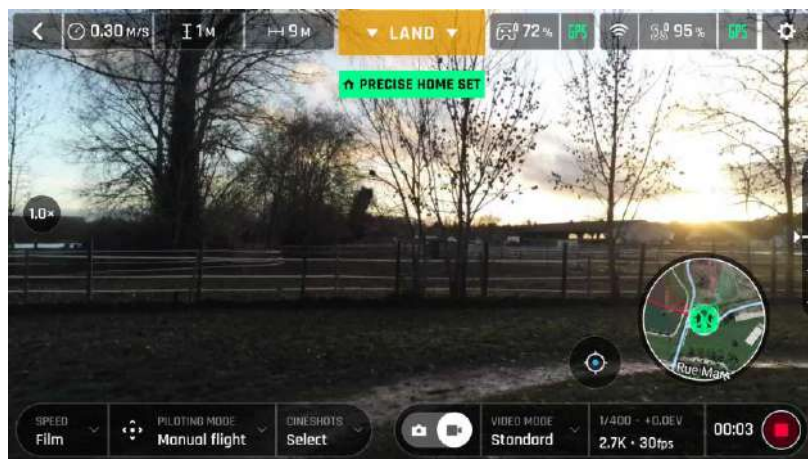

Android “Precise Home Set” pop-up

SMART RTH

ANAFI features a Smart RTH capability; considering its altitude and its distance from its take-off point, the drone computes in real time the power it needs to return home. When short on battery power, **FreeFlight 6** alerts you that it will enter automatic RTH mode.

If you feel confident you can bring **ANAFI** back to its take-off point or if you wish to land it at a different location, you can cancel the auto-RTH directly from the alert pop-up.

LANDING

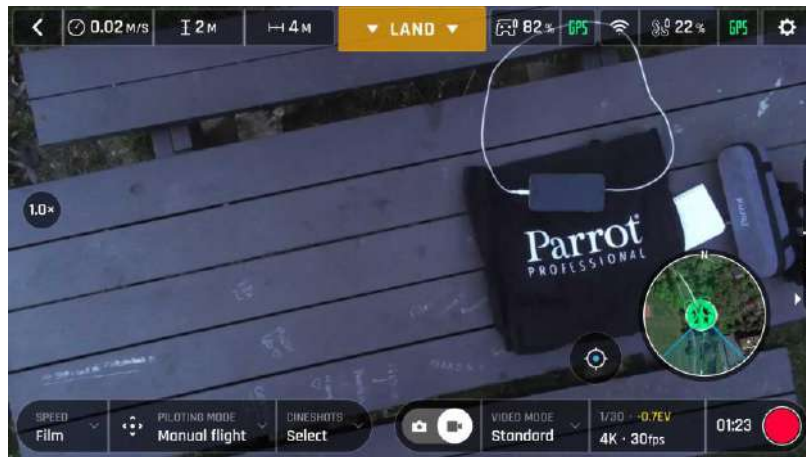

Setting up for landing, Android

Fly ANAFI directly over a flat, even, and clear surface, then press the  button, or tap the orange "LAND" box on the screen of your device.

ANAFI lands.

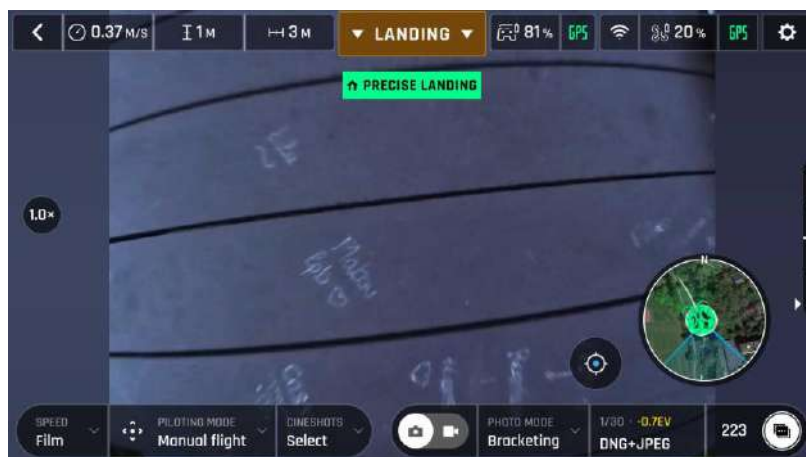

Precise Landing, Android

Hand landing

- ⚠ Be especially careful when you hand land ANAFI. This procedure is safe provided you are not distracted or startled by an outside event with a live drone approaching your hand: concentrate on what you are doing, but always stay aware of your surroundings.

Fly ANAFI at least 50 cm directly over your open hand then press the  button, or tap the orange "LAND" box on the screen of your device.

ANAFI lands on your hand.

SMART LIPO BATTERY

ANAFI's smart LiPo battery is preinstalled on the drone and should always be reinstalled in the same way, with the LEDs and power button facing up, to avoid irrecoverable electric damage to the battery, to the drone, or to both.

The smart battery can be charged whether it is installed on ANAFI, or not. However, you will need to remove the battery from the drone to access your microSD card. Refer to the *"Retrieving media"* section of this guide for further information.

- ⚠ When handling ANAFI, you should never apply pressure and generally avoid touching the drone's camera and gimbal – its most sensitive parts. The following directions will help you handle your drone and battery safely.

Battery removal

To remove the smart battery from the drone, unfold the back arms of ANAFI. Set the drone on a flat and even surface (such as a table), and press the push-button which connects the battery to the body of the drone with your thumb. Gently slide your thumb and the battery toward the back of ANAFI. When the hook of the push-button is disengaged from the body of the drone, lift the battery away from ANAFI.



ANAFI: battery removal

Battery installation

To install the smart battery back on the drone, unfold the back arms of ANAFI. Set the drone on a flat and even surface (such as a table), and position the battery's three hooks into the drone's corresponding slots. Place your middle finger on the Parrot logo of ANAFI and your thumb on the back of the smart battery. Squeeze your fingers together until you feel and hear the battery clicking into the body of the drone. You are set!



ANAFI: battery installation

Battery charging

To charge ANAFI's smart LiPo battery, use the enclosed USB-A to USB-C cable to plug the battery to a power source. This convenient cable enables you to charge your battery from:

- a wall socket, through an AC adapter (not included in the box);
- a tabletop or laptop computer's USB-A port;
- a power bank's USB-A port.

Indicative **full charging times** depending on power sources are as follows (at 20°C):

AC adapter (5V - 3A);	between 150 and 210 minutes;
a computer's or power bank's USB-A port;	between 270 and 320 minutes.

ANAFI's smart battery can also be recharged through a Power Delivery adapter or charger (USB-PD standard), using a USB-C to USB-C cable (not included in the box). In that configuration, full charging time of the battery can be reduced to 105 minutes.

- ⚠ **About USB-PD power banks:** Parrot does not recommend ANAFI users to invest in a **USB-PD power bank**, as not all of them support USB-C to USB-C charging of ANAFI's battery. Indeed, due to the nature of the USB-C technology, some USB-PD power banks recharge on ANAFI's smart battery, rather than the other way around.

ANAFI

When **ANAFI's** smart LiPo battery is plugged to a power source and charging, **its 4 LEDs indicate in real time its level of charge:**

LED 1 flashing:	battery is between 0 and 25% charged;
LED 1 steady & LED 2 flashing:	battery is between 25 and 50% charged;
LEDs 1 and 2 steady & LED 3 flashing:	battery is between 50 and 75% charged;
LEDs 1, 2 and 3 steady & LED 4 flashing:	battery is between 75 and 100% charged;
battery is plugged and all LEDs are off:	battery is full.

Similarly, when **your battery is not installed on ANAFI**, you can check its charge level at any time by pressing its power button:

1 steady LED lights up:	battery is between 0 and 25% charged;
2 steady LEDs light up:	battery is between 25 and 50% charged;
3 steady LEDs light up:	battery is between 50 and 75% charged;
4 steady LEDs light up:	battery is between 75 and 100% charged.

Finally, the same logic applies when **the smart LiPo battery is installed on the drone and when ANAFI is powered on**. The number of steady LEDs enables you to estimate your remaining flying time:

1 steady LED is lit up:	less than 6 minutes flying time remaining;
2 steady LEDs are lit up:	between 6 and 12 minutes flying time remaining;
3 steady LEDs are lit up:	between 12 and 18 minutes flying time remaining;
4 steady LEDs are lit up:	between 18 and 25 minutes flying time remaining.

Battery care and safety

As you can see, **ANAFI's** smart LiPo battery is as high-tech as any other element of your flying 4K HDR camera.

Its firmware can be updated, like that of the drone and that of the controller, and it even features a wintering mode, designed to increase its durability and facilitate its care. Ideally, when not in use for a prolonged period, batteries should be stored half-charged. When not in use for 10 days, **ANAFI's** smart battery discharges itself, if required, to 65% charge, over a 48h period. In other words, after a maximum of 12 days without use, this smart battery enters hibernation with a charge level which never exceeds 65%. If you leave your **ANAFI** battery for 12 days, you will find out its power button does not activate the charge level LED indicators. **The battery needs to be charged to exit the wintering mode and start operating as described in the earlier paragraphs: this behavior preserves the battery over time. Parrot recommends you always run a full charge of your smart battery before flying ANAFI.**

Like all other LiPo batteries, **ANAFI's** smart battery must be handled, transported and stored with care:

- never leave a battery unattended while charging;
- never expose a battery to extreme temperatures, neither hot, nor cold;
- never charge a battery which is still warm from use (wait for at least 20 minutes);
- never use or recharge a damaged or swollen battery;
- always store your battery in a dry, ventilated place, at a temperature close to 20°C;
- always carry your battery in a fire-retardant bag or case (unless it is installed on **ANAFI**: it can then be transported with the drone, inside its carrying case).

Finally, note that **ANAFI's** smart battery will only allow charge in ambient temperatures between +10°C and +45°C, and that using **ANAFI** in temperatures approaching 0°C will reduce its flying time. To minimize this slight drop in the smart battery's capacity, keep your battery as warm as possible before starting a flight in a cold environment.

- ⚠ **If the behavior of your battery is not consistent with the elements contained in this section, and if you cannot get it to power your ANAFI, you must hard reset your battery: plug it to a power source with the enclosed cable, then keep the battery's power button pressed for 15 seconds (regardless of the behavior of the LEDs), and release the button.**

The battery's LEDs flash quickly, one after the other, alternating green and red: the hard reset is successful!

MEDIA RETRIEVAL

Your ANAFI is equipped with a 16GB microSD card which enables you to record videos and photos, and to transfer them easily to your computer. This section explains how to extract the microSD card from ANAFI, how to retrieve your media from the microSD card, and how to reinstall it in the drone.

Extracting the microSD card

To extract the microSD card from ANAFI, the battery must be removed from the drone. Refer to the *"Battery removal"* section of this guide for details.

When you remove the battery from the body of the drone, you uncover the microSD slot, which is protected by a small metal lock.

Slide this metal lock with a finger toward the back of ANAFI to open it – you will feel a slight click. Lift the front part of the lock to open the slot. Reach the microSD card and extract it. An open lock icon and an arrow, located on the left of the microSD slot, confirm to you the way you must slide the lock to open it.

Retrieving photos and videos

Use the enclosed microSD to SD card adapter to transfer videos and photos you have taken with ANAFI to your computer. Slide the microSD card into the adapter and use the adapter how you would use any other SD card: access your videos and photos through a card reader or the SD card slot of your computer. Copy your videos and photos to the hard drive of your computer to edit, store, and manage your media.

- ⚠ The enclosed 16GB microSD card enables you to record just over 20 minutes of 4K video. For this reason, Parrot recommends you backup your photos and videos, and you empty your 16GB microSD card after each flight, to ensure you always have available memory space to capture new still or moving images.

Installing the microSD card

To install the microSD card back into its slot, open the metal lock as you did when you extracted the card from ANAFI. Position the microSD card into its keyed slot: make sure the metal contacts of the card are facing down and set on the contacts of the drone. The shortest side of the microSD card should be facing toward the back of the drone.

Tilt the metal lock over the microSD card. Press a finger gently on the lock and slide it toward the front of ANAFI to close and lock it – you will feel a slight click. A closed lock icon and an arrow, located on the right of the microSD slot, confirm to you the way you must slide the lock to close it.

Compatible microSD cards

Refer to Parrot online documentation for an updated list of ANAFI compatible microSD cards.

Direct media retrieval (drone to computer)

You can also retrieve your media directly from ANAFI, without extracting the microSD card.

Use the enclosed USB-A to USB-C cable to connect the drone (USB-C) to a USB-A port of your computer. Power **ANAFI** on.

ANAFI mounts as any other external drive: copy your media from the DCIM/100MEDIA directory to your computer's hard drive.

When you are done managing your media, eject **ANAFI** as any other external drive.

- ⚠ **When plugged in to a computer and powered on, ANAFI's battery discharges itself.** This means you must recharge your smart battery after you have retrieved your media, even if it was fully charged when you began the procedure.

FreeFlight 6 Gallery

Finally, you can manage your media and download them directly from ANAFI to your device with the Gallery of FreeFlight 6.

The Gallery also lets you:

- preview videos, without downloading them to your device;
- create panoramas (refer to the "*Creating panoramas*" section of this guide for additional details).

To access the Gallery from the homepage of FreeFlight 6, either by tap the "microSD card" box, on the top bar of the interface, or tap the "Gallery" box, at the center of the interface.

If **ANAFI** is powered on and connected to the device (directly or through the **Parrot Skycontroller 3**), the **FreeFlight 6** Gallery displays the microSD card media, by default.

Tap any media to preview it.

Tap any green media download box to transfer the corresponding media to your device.

Access the media you have downloaded to your device by tapping the "Local" box, at the top of the interface.

INTRODUCING FREEFLIGHT 6

The HUD (head-up display) interface of FreeFlight 6 is the ultimate companion to ANAFI. It enables you to access all the outstanding features of ANAFI, from the screen of your device, at the touch of your thumbs.

This section explores FreeFlight 6 functions, starting with a presentation of the top and bottom bars of the HUD (iOS and Android).

Access the HUD by tapping "FLY" on the bottom right of the homepage of FreeFlight 6.

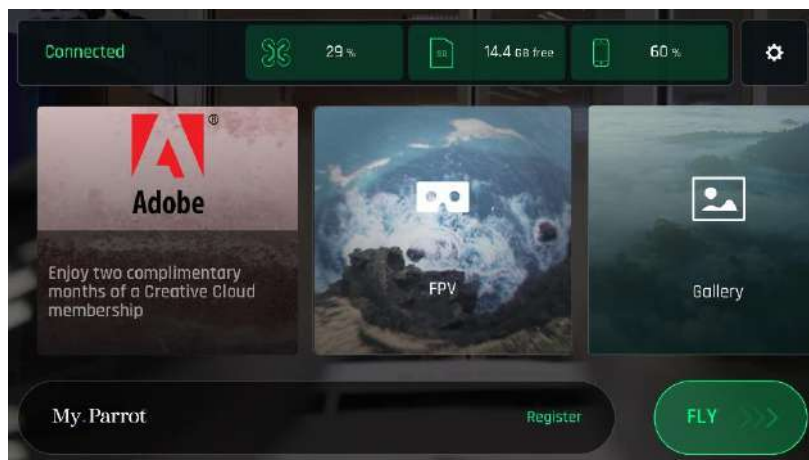

iOS FreeFlight 6 homepage

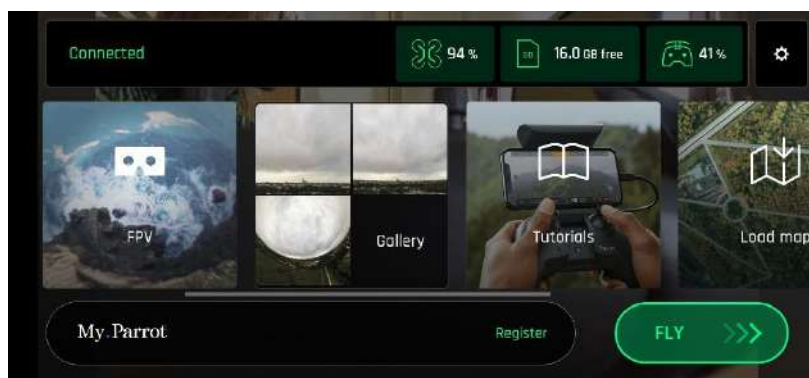

Android FreeFlight 6 homepage

Presentation of the iOS HUD (video mode view)

ANAFI horizontal distance from pilot
 ANAFI height relative to take-off point
 ANAFI ground speed
 Back to homepage
 Next available action
 Controller box (charge and GPS synch)
 ANAFI box (charge and GPS synch)
 Preferences

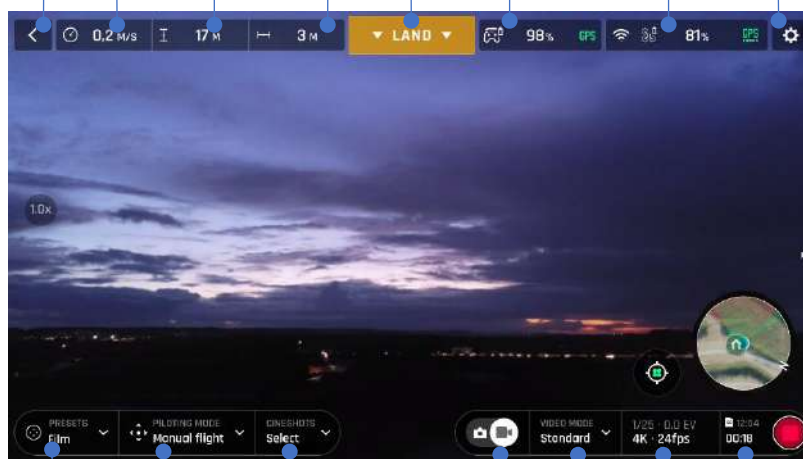

Presets (Film, Sport, Cinematic or Racing) & Control mode box
 Piloting mode box
 Cineshots box
 Photo/video toggle
 Video mode box
 Video settings box
 Soft shutter button and timer

ANAFI and FreeFlight 6 are packed with features which are accessible from the HUD. Before we present the "PREFERENCES" menu of FreeFlight 6, here is an overview of your drone's current piloting, Cineshots, Dronies, and video modes.

Piloting modes:
 Manual flight
 Cameraman
 Follow Me (in-app purchase)
 Smartdronies
 FPV
 Flight Plan (in-app purchase)
 Touch & Fly: Waypoint & POI

Cineshots:
 360° (left & right)
 Reveal (30 & 60m)
 Spiral (30 & 60m)
 Epic (30 & 60m)

Smartdronies & POI Dronies
 Orbit
 Parabola
 Dolly Zoom
 Boomerang

Video modes:
 Standard
 Cinema
 Hyperlapse
 High-Framerate
 Slow Motion

Follow Me (in-app purchase) Dronies
 Orbit
 Parabola
 Tornado
 Boomerang

ANAFI

The Android HUD of **FreeFlight 6** displays strictly the same information, buttons, toggles, and menus as the iOS HUD, in the same way - despite slight cosmetic differences.

- ⚠ Note that both GPS icons are green, on both screen captures (iOS and Android screen presentations). This means that the drone's controller (Skycontroller 3 or device) and ANAFI are both synchronized to enough GPS and Glonass satellites to optimize the stability of the drone, especially at higher altitudes.

Parrot therefore recommends you always check both your FreeFlight 6 HUD's GPS icons are green (and not red), before you make your ANAFI take off.

Presentation of the Android HUD (photo mode view)

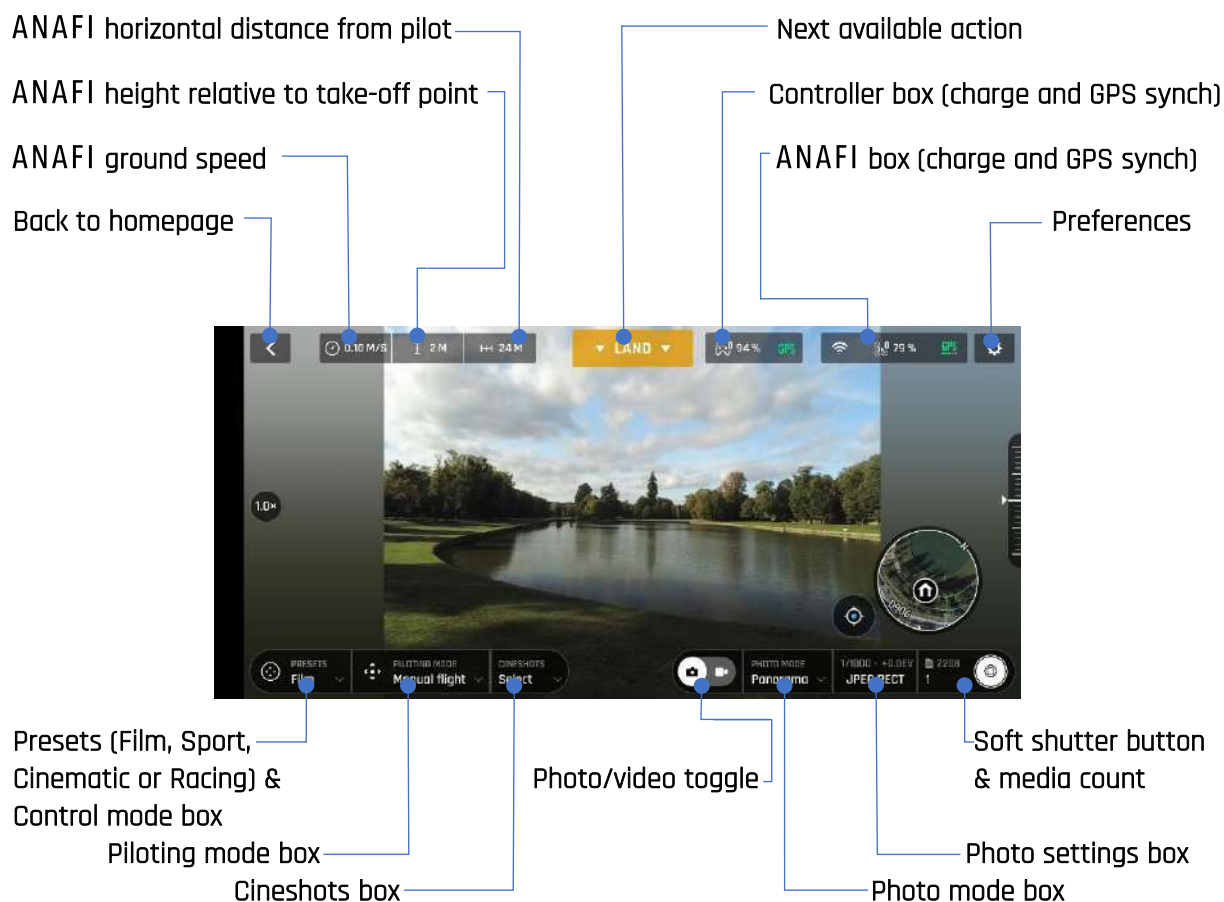

ANAFI's photo modes include a Single shot mode, a Burst mode, a Bracketing mode, a Timer mode, a five-format Panorama mode, a Timelapse mode and a GPS Lapse mode..

The Android HUD of **FreeFlight 6** displays strictly the same information, buttons, toggles, and menus as the iOS HUD, in the same way - despite slight cosmetic differences.

⚠ Note that both GPS icons are green, on both screen captures (iOS and Android screen presentations). This means that the drone's controller (Skycontroller 3 or device) and ANAFI are both synchronized to enough GPS and Glonass satellites to optimize the stability of the drone, especially at higher altitudes.

Parrot therefore recommends you always check both your FreeFlight 6 HUD's GPS icons are green (and not red), before you make your ANAFI take off.

PREFERENCES

Access **FreeFlight 6** preferences through the icon on the extreme right of the top bar of the homepage, or that of the HUD. Preferences enable you to fine-tune **ANAFI** to your hand – to customize it, to fit your piloting and filming styles.

Access **Preferences** submenus from the boxes on the left of the screen. Tap a box to select it and access its items.

For all items, **default values (DV)** are marked in **bold characters**.

Controls

The Controls preferences set the way your controller behaves. It also enables you to activate the “Hand-launch” option.

Tap an item option to select it.

Control mode:	CLASSIC / ARCADE (only available in flight)
Inverse joys	OFF (white) / ON (green)
Special	OFF (white) / ON (green)
EV Trigger	OFF (white) / ON (green)
Hand-launch	NO / YES

About EV Trigger: when activated, the EV Trigger enables you to control the EV (exposure value) directly from the zoom (right) trigger of the **Parrot Skycontroller 3**. (refer to the *“PARROT SKYCONTROLLER 3 PRESENTATION”* section of this guide for additional information). With this setting, you can therefore manually modify your EV from -3.0 to +3.0, by increments of 0.3, which automatically impacts the shutter speed (“s” value) of the camera.

Tap “RESET ALL CONTROL PREFERENCES” on the bottom of the page to reset preferences.

Presets

The Presets preferences allow you to adapt the flight behavior of **ANAFI** for each of four modes (“Film”, “Sport”, “Cinematic” and “Racing”).

Tap an item option to select it.

Global reactivity:	1% to 100% (DV: 15% for FILM & CINEMATIC ; 20% for SPORT ; 30% for RACING)
Horizon	FIXED / DYNAMIC (DV: FIXED for FILM & SPORT ; DYNAMIC for CINEMATIC & RACING)
Camera tilt speed	1°/s to 180°/s (DV: 10°/s for FILM & CINEMATIC ; 20°/s for SPORT & RACING)
Banked turn	NO / YES (DV: YES for FILM, CINEMATIC & RACING ; NO for SPORT)
Inclination	1°/s to 40°/s (DV: 10°/s for FILM ; 20°/s for CINEMATIC ; 25°/s for SPORT & RACING)

Vertical speed	0.1m/s to 4m/s (DV: 1m/s for FILM ; 2m/s for SPORT ; 2.5m/s for CINEMATIC ; 3m/s for RACING)
Rotation speed	3°/s to 200°/s (DV: 10°/s for FILM ; 20°/s for SPORT & CINEMATIC ; 40°/s for RACING)

About Horizon and Banked turn: refer to in-app information for details about these features.

⚠ **Note that “Global reactivity”, “Inclination”, “Vertical speed” and “Rotation speed” values are the ones which carry the biggest impact on ANAFI’s acceleration and general flying behavior. Corresponding sliders turn to orange instead of green to warn users the settings they have selected require extreme care, superior piloting skills, or both, when flying ANAFI. Your drone will always remain outstandingly responsive, but with extreme settings, it will accelerate much more rapidly than you can imagine: you have been warned!**

Tap “RESET ALL PRESETS PREFERENCES” on the bottom of the page to reset the corresponding Mode to its default values. In other words, you must tap “RESET ALL PRESETS PREFERENCES” in each Mode to revert all Modes to their default values.

Interface

Interface preferences set the amount of information which appear on your **FreeFlight 6** HUD.

- Show minimap NEVER / WITH CONTROLLER / **ALWAYS**
- Map type ROADMAD / SATELLITE / **HYBRID**
- Show framing grid **NO** / 3x3 / 6x6
- Measurement system **AUTO** / IMPERIAL / METRIC
- FPV Goggles Tap “**CHANGE**” to access the following options:

Parrot - CockpitGlasses 1	/	Homido
Parrot - CockpitGlasses 2	/	Merge VR
Parrot - CockpitGlasses 3	/	BNext
Google - DayDream View	/	Skillkorp VR5
Homido V2	/	Zeiss VR One
Homido Prime		

 Tap “**TEST**” to verify the rendering of your selection

Safety

Through Safety preferences, you can set a safe and clear flying area for **ANAFI**.

Set **ANAFI**'s maximum flight altitude with the “Max altitude” slider.

To set a maximum distance from the pilot for your drone, move the “Max distance” slider to the required value.

ANAFI

When the Geofence is activated, ANAFI will automatically stop when it reaches the maximum altitude or the maximum distance you have selected: a red prompt will also appear on your HUD.

Geofence	NO / YES
Max altitude	1m to 150m (DV: 30m)
Max distance	10m to 4 km (DV: 300m)
Minimum altitude when using RTH	20m to 100m (DV: 30m)

Tap "RESET ALL SAFETY PREFERENCES" on the bottom of the page to reset preferences.

Camera

Camera preferences enable you to select camera options, both in photo and video modes.

Camera calibration	Tap "CALIBRATE" to access "Correct horizon" & "Gimbal Calibration" features.
Auto record from take-off	NO/ YES (video only)
Lossless zoom only	NO / YES (selecting "YES" blocks zoom in JPEG RECT)
Display overexposure	NO / YES
Anti-flickering	OFF / AUTO / 50Hz / 60 Hz

About Correct horizon: only resort to the "Correct horizon" procedure if you notice your videos and photos are systematically tilted on the same side. Refer to the "*Camera calibration*" section of this guide for the detailed procedure.

About Overexposure display: when this setting is activated, the HUD of **FreeFlight 6** shows all overexposed areas of the screen as hatched, which enables you to fine-tune your framing, your EV settings, or both.

About Anti-flickering: this setting and the associated technology aim at eliminating the flicker effect which can arise due to some artificial lights. The "AUTO" option should work for most users, but depending on your country, you can try other settings if you feel bothered by a flicker effect on your device's screen, your artificial light videos, or both.

Tap "RESET ALL CAMERA PREFERENCES AND SETTINGS" on the bottom of the page to reset preferences.

Network

Network preferences let you change your **ANAFI's** Wi-Fi network name, password, and band.

Network's name	Tap the field to change your ANAFI's network name
Password	Tap the box to change your network's password
Wi-Fi band	AUTO / MANUAL

VIDEOS AND PHOTOS

ANAFI is equipped with a state-of-the-art 4K, 3-axis-stabilized camera, which delivers astoundingly sharp motion and still pictures, through a 1/2.4" CMOS 21MP sensor.

The lens of the camera includes low dispersion aspherical elements, that reduce chromatic aberrations and flare, and guarantee optical excellence to such a small, smart and versatile airborne imaging system.

Although you can film and take pictures using your device as ANAFI's only controller, we recommend you always use the Parrot Skycontroller 3 and your device, for the best controlled, most precise, and safest filming and photos-shooting flights.

Making videos

By default, ANAFI and FreeFlight 6 are set to start recording a video as soon as ANAFI takes off. This literally means all you have to do, to start filming, is to fly ANAFI into the sky!

However, depending on your filming objectives, ANAFI and FreeFlight 6 offer a wealth of settings, from full auto to manual professional options, for you to make the most of every situation.

If required, tap the photo/video toggle in the middle of the bottom bar of the HUD, to circle the film camera (right icon) in white.

Main filming options are twofold, and accessible from the HUD of FreeFlight 6.

First, select a **video mode** by tapping the corresponding box of the HUD.

The options appear on your device, as they do on the screen capture below. Tap a video mode to select it and tap the **video mode** box again to confirm your choice.

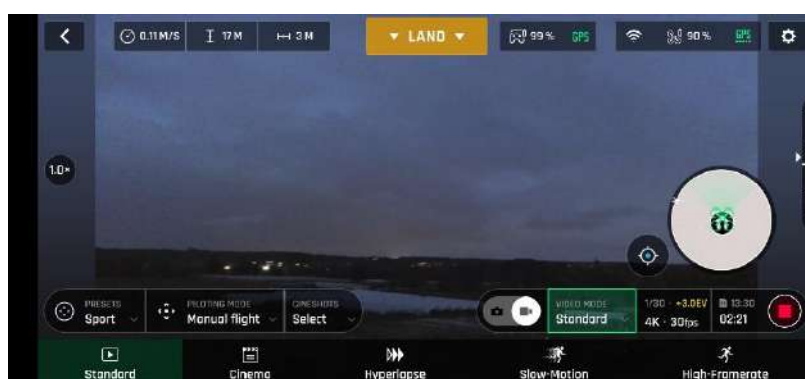

Android Video mode menu

Second, select a **video resolution and a framerate (fps - frames per second) value** from the corresponding box of the HUD.

Tap the **video settings** box to call the individual **video resolution** and **fps** boxes.

Tap the **video resolution** box to access the available video resolutions and tap one to select it.

Tap the **fps box** to access the available fps values and tap one to select it.
 Tap the **video settings box** again to close the sub-boxes and confirm your choices.

Available video resolutions and fps values depend on the video mode you have selected:

Standard:	all-round 4K, 2.7K or 1080p filming, at 24, 25 or 30fps .
Cinema:	spectacular 4K cinema filming, at 24fps .
Hyperlapse:	time-lapse video with a configurable speed factor (x15, x30, x60, x120, x240), in 4K, 2.7K or 1080p , exported at 24, 25 or 30fps .
Slow-Motion 1080p	filming at 48, 50 or 60fps , automatically slowed down by a factor of 2 (x0.5) and exported at 24, 25 or 30fps.
Slow-Motion 720p	filming at 96, 100 or 120fps , automatically slowed down by a factor of 4 (x0.25) and exported at 24, 25 or 30fps.
High-Framerate:	1080p filming at 48, 50 or 60fps (ideal for post-processing) and 720p filming at 96, 100 or 120fps .

In the following screen capture, **Standard video mode** is activated: available video resolutions are **4K (UHD), 2.7K and 1080p (FHD)** – either in **24, 25 or 30fps**, which you would find out by tapping “30 fps” on the bottom right of the screen.



iOS Standard video format menu

When you are happy with your settings and your framing, press the hard shutter button on the right of **Parrot Skycontroller 3** (or tap the soft shutter button of the HUD) to start filming.

The soft shutter button of the HUD animates and displays a cycle between red square, and red circle. The timer starts running.

Press the hard shutter button of the controller (or tap the soft shutter button of the HUD) again to end the recording. The soft shutter button of the HUD comes back to steady, red and round. The timer resets.

Taking photos

To access the photo camera of ANAFI, tap the photo/video toggle in the middle of the bottom bar of the HUD, to circle the photo camera (left icon) in white.

Seven photo modes are available on ANAFI: Single shot, Burst, Bracketing, Timer, Timelapse, GPS Lapse and Panorama (5 formats).

Thanks to its 21MP CMOS sensor, ANAFI produces three main picture formats:

rectilinear (up to 16MP) or wide (21MP) JPEG;
wide 21MP JPEG and DNG (Digital NeGative: Adobe open standard RAW format);
composite panoramas (JPEG), up to 32MP.

Main photography options are accessible from the HUD of FreeFlight 6.

First, select a **photo mode** by tapping the corresponding box of the HUD. The options appear on your device. Tap a photo mode to select it and tap the **photo mode** box again to confirm your choice.

When the **"Single"** mode is selected, the soft shutter button of the HUD appears as a full white circle.

When the **"Burst"** mode is selected, the soft shutter button of the HUD displays the Burst icon inside a white circle.

Selecting the **"Bracketing"** mode opens three options: 3 photos (-1 EV, +0.0 EV, +1 EV), 5 photos (-2 EV to +2 EV) and 7 photos (-3 EV to +3 EV). When one of these options has been selected, the soft shutter button of the HUD displays the Bracketing icon inside a white circle.

Selecting the **"Timer"** mode opens three options: 3 secs, 5 secs and 10 secs. When one of these options has been selected, the soft shutter button of the HUD displays "3 secs", "5 secs" or "10 secs" inside a white circle, depending on the option which has been chosen.

Selecting the **"Panorama"** mode opens three options: Vertical, Horizontal and 360. When one of these options has been selected, the soft shutter button of the HUD displays the corresponding icon inside a grey (ANAFI landed) or white (ANAFI flying) circle.

The Panorama mode is indeed the only photography mode which requires the drone to be flying before you can activate the shutter. Refer to the next section, **"Generating Panoramas"**, for additional details about the "Panorama" mode.

Selecting the **"Timelapse"** mode opens six options: 5 secs, 10 secs, 15 secs, 30 secs, 60 secs, and 120 secs. When one of these options has been selected, the soft shutter button of the HUD displays a Timelapse icon.

Selecting the “GPS Lapse” opens six options: 5m, 10m, 20m, 50m, 100m, and 200m. When one of these options has been selected, the soft shutter button of the HUD displays a GPS Lapse icon.

Second, select a **photo format** from the corresponding box of the HUD.

Tap the **photo settings box** to call the **photo settings** boxes.

Tap the **last box on the right** of the screen to access the **available photo formats**.

Available photo formats for each photo mode are as follows:

Single: JPEG RECT, JPEG WIDE, DNG+JPEG (RECT or WIDE)

Burst: JPEG RECT, JPEG WIDE

Bracketing: JPEG RECT, JPEG WIDE, DNG+JPEG (RECT or WIDE)

Timer: JPEG RECT, JPEG WIDE, DNG+JPEG (RECT or WIDE)

Panorama: JPEG RECT only

Timelapse: JPEG RECT, JPEG WIDE, DNG+JPEG (RECT or WIDE)

GPS Lapse: JPEG RECT, JPEG WIDE, DNG+JPEG (RECT or WIDE)

Tap a format (JPEG RECT, or JPEG WIDE if available, or any DNG+JPEG format if available) to select it.

Tap the photo settings box again to close the sub-boxes and confirm your choice.



Android photo formats: DNG+JPEG WIDE (zoom is locked, stream image is WIDE)



Android photo formats: DNG+JPEG RECT (zoom is unlocked, stream image is RECT)

When you are happy with your settings and your framing, press the hard shutter button on the right of the **Parrot Skycontroller 3** (or tap the soft shutter button of the HUD) to take a photo.

In **"Single"** mode, the screen flashes white then freezes briefly in black and white to confirm a picture has been taken. The number to the left of the soft shutter button (the number of media on the microSD card) of the HUD is increased by 1.

In **"Burst"** mode, the screen flashes white then freezes briefly in black and white to confirm 14 pictures have been taken in the span of 1 second. The number to the left of the soft shutter button of the HUD is increased by 14.

In **"Bracketing"** mode, the screen flashes white then freezes briefly in black and white to confirm 3, 5 or 7 pictures have been taken. The number to the left of the soft shutter button of the HUD is increased by 3, 5 or 7, depending on your option choice.

In **"Timer"** mode, the countdown is displayed (from 3, 5 or 10 seconds) at the center of the HUD, the timer of the soft button also countdowns, then the screen flashes white and freezes briefly in black and white to confirm a picture has been taken. The timer of the soft shutter button resets. The number to the left of the soft shutter button of the HUD is increased by 1.

For additional details on the **"Panorama"** mode, refer to the next section, *"Generating Panoramas"*.

In **"Timelapse"** mode, the screen flashes white then freezes briefly in black and white to confirm a picture has been taken. 5 to 120 seconds later, depending on your option choice, the drone takes another photo, and so on until you press the shutter button again to stop the Timelapse. Between each shutter action, a green progress bar, at the bottom of the screen, serves as a countdown. At the end of the Timelapse, the number to the left of the soft shutter button reflects the total number of medias on the microSD card of the drone.

In **"GPS Lapse"** mode, the screen flashes white then freezes briefly in black and white to confirm a picture has been taken. Control and move **ANAFI**: when the drone reaches any point on a 5 to 200-meter bubble around the initial photo, depending on your option choice, the drone takes another photo, and so on until you press the shutter button again to stop the GPS Lapse. Between each shutter action, a green progress bar, at the bottom of the HUD, lets you estimate the distance the drone must cover before the next shot. At the end of the GPS Lapse, the number to the left of the soft shutter button reflects the total number of medias on the microSD card of the drone.

About ANAFI photo formats:

JPEG RECT:	4:3 aspect ratio, up to 16MP and 75.5° horizontal field of view (HFOV)
JPEG WIDE:	4:3 aspect ratio, 21MP, 84° HFOV – zoom is disabled for this format
DNG+JPEG:	4:3 aspect ratio, 21MP, 84° HFOV – zoom is disabled for WIDE option

- ⚠ **The DNG+JPEG option produces at least 2 files (1 DNG, 1 JPEG) for each shutter action.** As other RAW picture formats, **DNG is a very useful format for professional photography** processing and workflow. Indeed, RAW formats retain all the information gathered by photography sensors, contrary to JPEG formats – which are compressed and processed renderings of this comprehensive information. In consequence, RAW pictures such as **ANAFI's DNG are heavy files, but they offer the very best post-processing and retouching possibilities.**

Creating Panoramas

ANAFI panoramas are generated automatically through the gallery of **FreeFlight 6**, based on a series of pictures taken by the drone.

The generation of a panorama, regardless of its format, implies three phases:

- collecting the pictures**, in flight;
- downloading the pictures** from ANAFI to your device;
- stitching the pictures together** to create the panorama, on your device, through the gallery of **FreeFlight 6**.

Before shooting a panorama:

Make sure you are not flying lower than 10 meters (30ft) over water.

Make sure no object nor subject are present in a 10 meters (30ft) radius around ANAFI.

Bear in mind ANAFI locks the exposure (refer to the "*AE Lock*" section of this guide for additional information on exposure locking) **of the frame with which you start your panorama.** For this reason, Parrot recommends you always frame the main subject of the intended panorama before pressing the shutter button.

Bear in mind ANAFI will not enable you to proceed with a panorama if the drone is short on power (capturing a 360 Panorama takes ANAFI up to 3 minutes).

To capture a panorama, select the "Panorama" box from the "Photo Mode" menu of the HUD. Then, tap the panorama type you want to select it: **Vertical**, **Horizontal** or **360**. The soft shutter button icon reflects your choice, as on the screen capture below.



Android Panorama types

When you are happy with your framing, press the hard shutter button on the right of the **Parrot Skycontroller 3** (or tap the soft shutter button of the HUD) to begin the Panorama capture. **ANAFI** starts taking pictures and the bottom of the HUD displays a progress bar which fills with green as the capture unfolds.

Panorama types capture characteristics:

- Vertical:** ANAFI takes 8 photos in about 35 seconds
- Horizontal:** ANAFI takes 10 photos in about 40 seconds
- 360:** ANAFI takes 42 photos in about 180 seconds (3 minutes)

To download the Panorama pictures to your device, land **ANAFI**, access the homepage of **FreeFlight 6** and tap the **microSD card box** or the **Gallery box** to display the media present on your microSD card. Like other media, Panoramas are marked with their distinct icon and a green download box, which shows the size of the corresponding series of pictures.

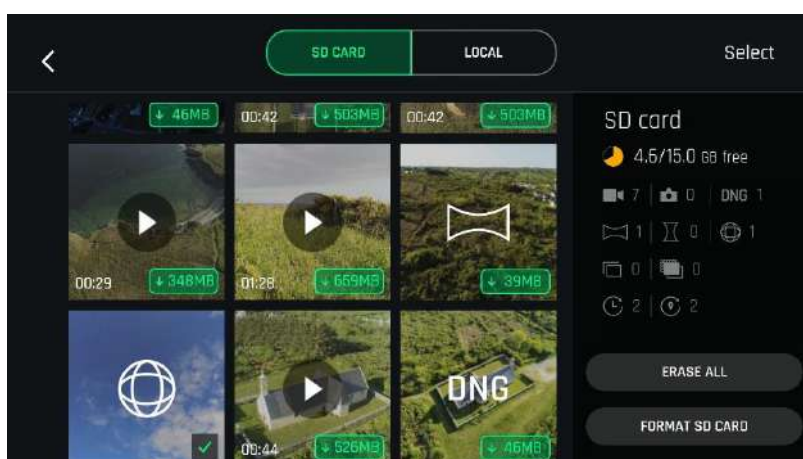

Android microSD gallery; a 360 panorama has been downloaded to the device

Tap the green box of the Panorama you want to generate to start downloading the corresponding series of pictures to your device. When the download is complete, **FreeFlight 6** displays a page from where you can delete the downloaded photos: tap

“Yes” to keep the originals on the microSD card; tap “No” to delete them. **FreeFlight 6** displays the Local (device) gallery, which contains only the media you have downloaded from **ANAFI**'s microSD card.

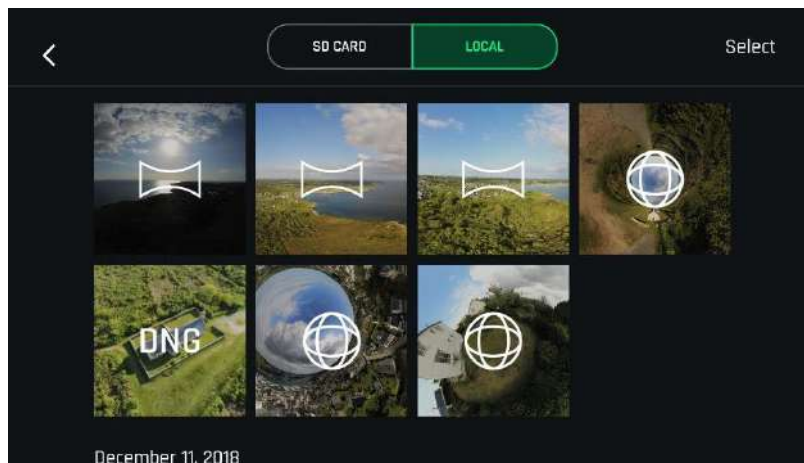

Android Local (device) gallery

Finally, select the panorama you want to generate from your Local gallery: **FreeFlight 6** displays the following screen.

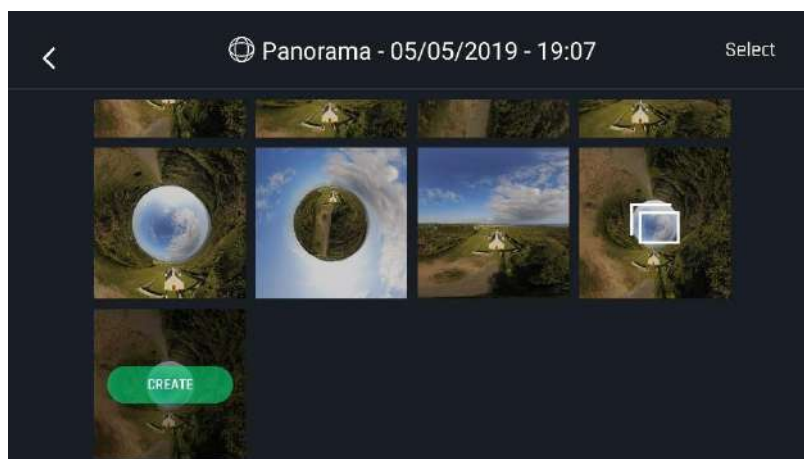

Android Local (device) panorama generation page

Tap “**Create**” to generate the panorama (or tap the other icon to access the series of individual pictures).

Depending on the power of your device, **FreeFlight 6** may display one or two resolution options, up to 32 MP. Select the option you want to launch the generation. The time this process takes also depends on your device's power. For the highest quality 360 panorama (32 MP), it can take several minutes.

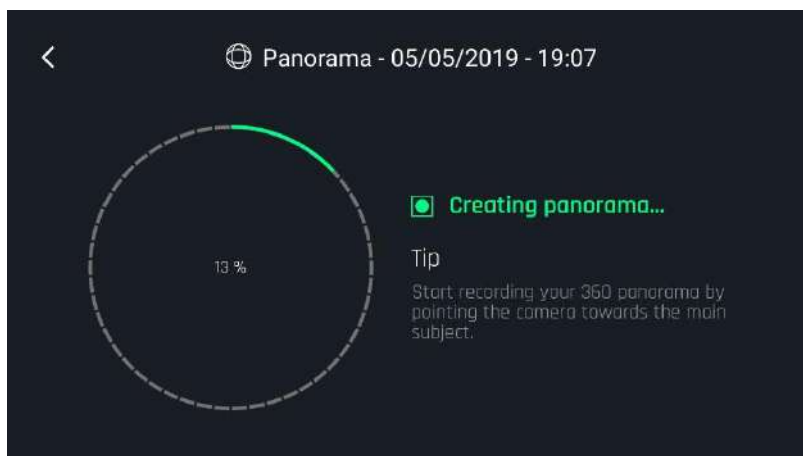

Android: Creating panorama

When the panorama creation is complete, **FreeFlight 6** displays the panorama and gives you the option to delete the original files.

- ⚠ For each **Vertical** or **Horizontal** panorama capture, you will be able to generate one panorama only.
- ⚠ For each **360** capture, you will be able to generate three different preset panoramas (**Sphere**, **Little Planet** and **Tunnel**) and a potentially infinite number of custom panoramas, through the 360 editor.
- ⚠ Do not worry about stitching issues on your 360 editor screen, when you create a custom panorama: the direct rendering is a preview only. For each custom panorama you decide to create, **FreeFlight 6** completely reprocesses the data to minimize stitching issues and discrepancies.



An example of custom panorama

GIMBAL TILT AND ZOOM CONTROLS

Two of ANAFI's main assets are its gimbal tilt control capabilities (180°, from the ground to the sky), and its zoom. This section presents these features and the way to activate them.

Gimbal tilt control

ANAFI's gimbal tilt control is activated through the left trigger of Parrot Skycontroller 3. It is available in all video and photo modes, and in all manual piloting modes.

To aim the gimbal toward the ground, push the tilt control trigger down.

To aim the gimbal toward the sky, pull the tilt control trigger up.

To reset the gimbal tilt to a horizontal position, press the optics reset button on the left of Parrot Skycontroller 3 (this action also resets the zoom factor of the lens to x1).

Zoom control

ANAFI's zoom control is activated through the right trigger of Parrot Skycontroller 3. It is available in all video modes, and in JPEG RECT photo mode (with an impact on the final resolution of your pictures). WIDE photo modes imply the use and rendering of all 21MP delivered by ANAFI's CMOS sensor: zoom is deactivated in both WIDE photo modes.

To zoom in on a subject, push the zoom trigger down.

To zoom out, pull the zoom trigger up.

Pressing the optics reset button on the left of Parrot Skycontroller 3 instantly resets the zoom factor of the lens to x1 (this action also resets the gimbal tilt to a horizontal position).

The HUD of FreeFlight 6 presents precise, decimal-by-decimal zoom information at all times, in the middle of the left side of the screen, as shown on the following screen captures – note that in these examples, ANAFI's gimbal is tilted all the way toward the ground.

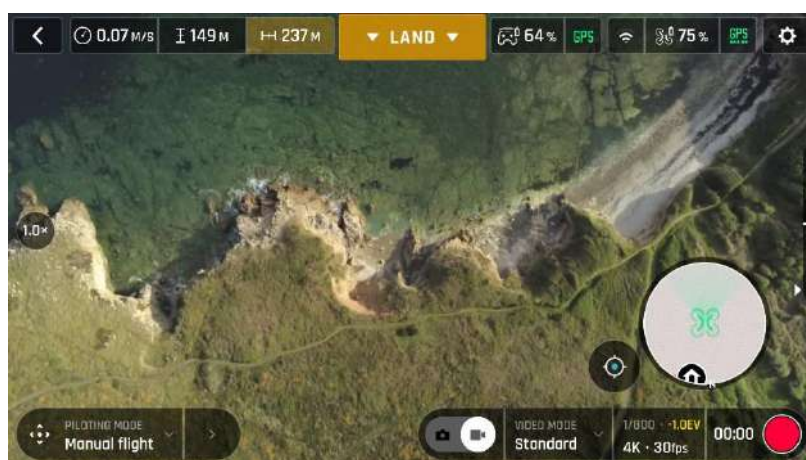

Android 4K x1 zoom

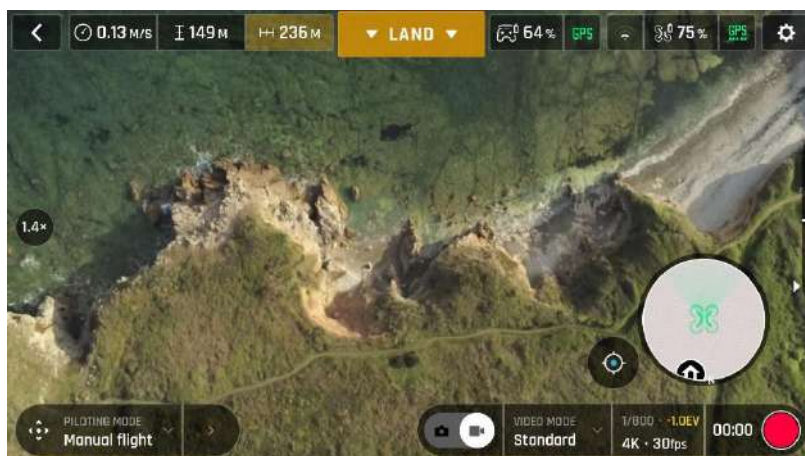

Android 4K x1.4 zoom

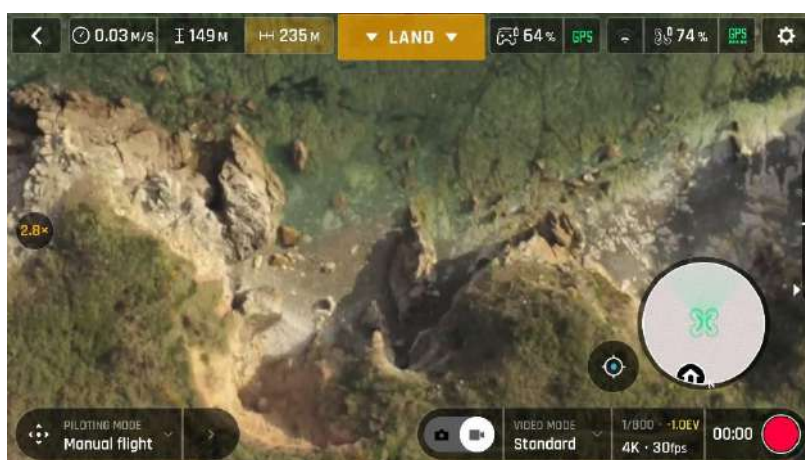

Android 4K x2.8 zoom

As already mentioned, **ANAFI** presents no lossless zoom capabilities for pictures: the zoom is deactivated by design in WIDE formats (JPEG and DNG+JPEG), and it has an impact on the resolution of the pictures in JPEG RECT format.

By contrast, **ANAFI** offers impressive lossless zoom capabilities for 4K UHD (x1.4), 2.7K (x1.9) and 1080p (x2.8) videos.

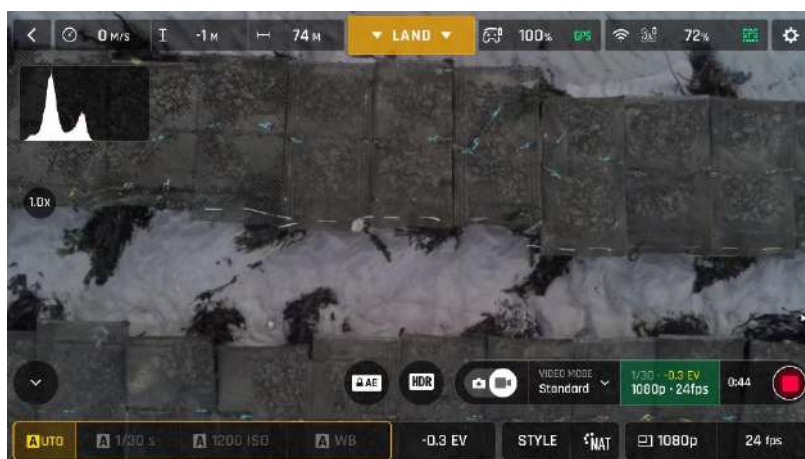

iOS 1080p x1 zoom

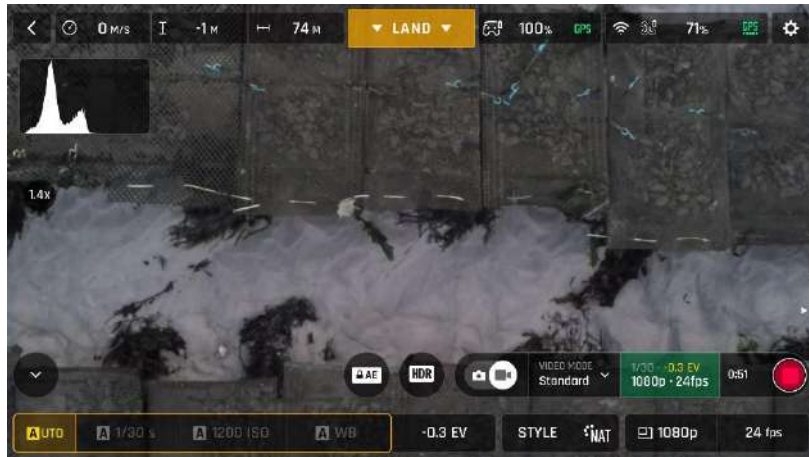

iOS 1080p x1.8 zoom

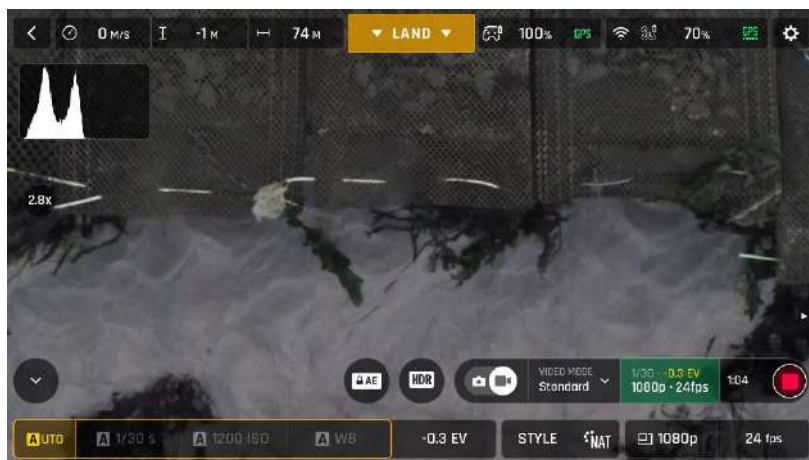

iOS 1080p x2.8 zoom

Note that in the video mode, when you leave the lossless envelope of the zoom, the zoom indicator, on the middle left of the HUD, turns orange instead of white.

Camera Calibration: Correct horizon (exceptional procedure)

- ⚠ **Your ANAFI's camera has been factory-calibrated with unparalleled precision.** Unlike the calibration of **ANAFI** or that of the **Parrot Skycontroller 3**, which must be carried out periodically, **the camera calibration must not be carried out unless it appears necessary** - typically, after a crash. If you notice **a tilted horizon on all your videos and photos**, and if this **tilt is always on the same side**, access camera calibration to make your horizon perfectly straight again.

This feature is accessible from the **ANAFI** box on the **FreeFlight 6** homepage (or from the **ANAFI** box of the HUD) and from the *"PREFERENCE - Camera"* menu.

Before starting this procedure, you need to position **ANAFI** on a flat and perfectly level surface, exactly perpendicular to any pattern containing straight lines you can use as horizon references. A set square can help you check that a line on your floor is perpendicular to your wall, as on the following pictures.



Finding a line perpendicular to the wall



ANAFI ready for camera calibration

ANAFI

When **ANAFI** is correctly positioned, perpendicular to its straight horizon reference, power it on, along with the **Parrot Skycontroller 3** and your device, as you would for any flight.

Access "Camera calibration" from the **ANAFI** box of the homepage or the HUD of **FreeFlight 6**, or from the "PREFERENCES-Camera" menu.

Select the "Correct horizon" option from the following screen.

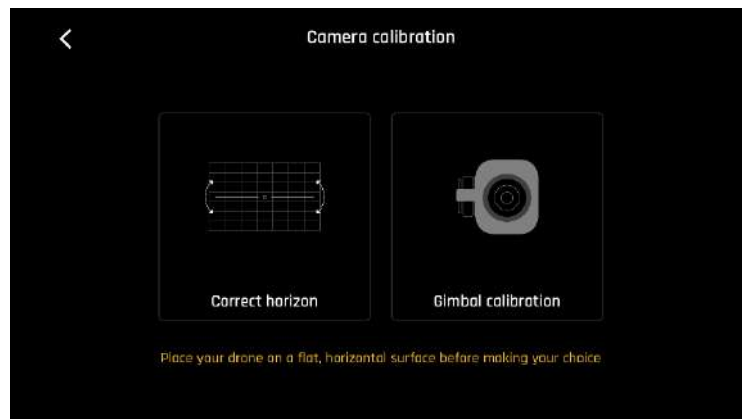

ANAFI: gimbal/camera calibration (Android)

The following screen appears - except the top line label ("*Gimbal calibration*"), has been replaced with "*Horizon correction*".



Gimbal/camera calibration: before (Android)

Tap "-" or "+" until the artificial horizon of **ANAFI** matches the horizon reference facing the drone. Do not worry about vertical lines: as you can see from the screenshots, they do not appear straight or parallel on the calibration screen.



Gimbal/camera calibration: after (Android)

When you have straightened the tilt of the camera, tap the "<" icon on the top left of the screen to confirm your setting and exit camera calibration.

Camera Calibration: Gimbal calibration

Use this option to perform a gimbal calibration, similar to that which occurs after **ANAFI** is powered on.

- ⚠ Be aware that **FreeFlight 6** can require you to carry out this procedure (as it can require you to perform a drone magnetometer calibration) before allowing you to fly **ANAFI**.

PRO-IMAGING SETTINGS

ANAFI is set to deliver high quality and balanced 4K videos and 21MP photos, out of the box.

Some image enthusiasts and all professional directors, videographers and photographers, however, will find their way through pro-imaging settings. This section is designed to help you exploit manual settings and develop your filming and photography styles.

The Exposure value (EV) is the only setting accessible in the Auto mode, from the "Video/Photo settings box" menu of the HUD.

Exposure value (EV)

The EV expresses the general darkness or lightness of a photograph – or a video. At +0.0 (zero) EV, ANAFI automatically adapts the shutter speed and the ISO value to deliver a perfectly balanced photo or video: not too dark and not too light.

Tap the "+0.0 EV" box to activate the EV slider.

Slide your finger on the screen to adapt your EV toward negative values and darken your picture or video.

Use positive values to lighten your images. This can be useful if you want to capture a backlit scene and to fade surroundings in light.



iOS -1.0 EV



iOS +1.0 EV

To activate further settings, tap "Auto", on the far left of the Video/Photo settings box. The additional settings boxes are unlocked, they stand out in white and "Auto" has been replaced with "Pro".

Shutter speed (s)

The "s" value refers to the time, in fraction of second, when the shutter stays open to capture a still picture: it is called exposure time.

In Auto mode, ANAFI selects the best shutter speed and ISO value couple, in real time, depending on the scene and available light. In consequence, selecting a shutter speed also deactivates the Auto ISO mode.

As **ANAFI**'s f/2.4 aperture lens lets a lot of light in, even compared to most professional SLR lenses, your drone can achieve very fast "s" values (down to 1/10000s) and capture very fast action. It can also be used for slow shots, up to 1 second for the photo mode.

Note that **ANAFI** can shoot pictures and videos when it is not flying. You can even hold it in your hand and use it as a premium stabilized 4K video and photo camera.

Tap the "s" box to open the shutter slider.

Select a value to exit the auto-mode for shutter speed and ISO. This action also deactivates the EV slider.

Set the s value you require, then tap the "ISO" box to select an ISO value. Experiment! The display of the HUD reflects your settings. If you get lost, tap Auto either on the "s" or the "ISO" slider to get back to auto exposure and reactivate the EV slider.

ISO value (ISO)

The ISO value refers to the sensitivity of the sensor. As we have seen, it is linked to the shutter speed value: both sliders activate when you deactivate the "Auto" mode and set a value for one, or for the other. The lower the ISO value, the lower the sensitivity of the sensor, and the lower the image noise (digital grain). Therefore, under good lighting conditions, such as sunny daylight outside shots, low ISO values (100 or 200) should always be selected. The sensitivity of the sensor increases as the ISO value goes up: 3200 ISO can be used to capture low light interior scenes, or exterior shots at dusk or dawn, for example.

By default, in Auto mode, **ANAFI** constantly adapts its ISO and shutter speed values to the scene it is filming. Setting an ISO value for a whole shot or series of shot, however, is very useful to professional filming.

Tap the ISO box to open the shutter slider.

Select a value to exit the Auto mode for ISO and shutter speed. This action also deactivates the EV slider.

Set the ISO value you require, then tap the "s" box to select a shutter value.

Experiment! The display of the HUD reflects your settings. If you get lost, tap Auto either on the "s" or the "ISO" slider to get back to auto exposure and reactivate the EV slider.

White balance (WB)

White balance deals with the color temperature of the light. Cold lights make the whites look blue. Warm lights make the whites look yellow. By default, in Auto WB mode, **ANAFI** keeps the whites white, at all times: it adapts its WB value in real time.

However, setting a WB value for an entire shot is especially useful for professional filming: stable WB facilitates the grading (color treatment) of videos.

Tap the WB box to open the white balance options.

ANAFI

Select the WB option that is best suited for your shooting conditions, your subject, or both- or tap the CUSTOM option to set the temperature of the light of your scene manually, between 2 000 and 10 000 K (kelvins).

The display of the HUD reflects your settings and helps you make the best choice.



Android Auto WB



Android Incandescent WB



Android Fluor WB



Android Sunny WB



Android Cloudy WB



Android Shaded WB



Android 2 000 K WB



Android 10 000 K WB

HDR

HDR (high dynamic range) is another great way to enhance a video or a photo. The HDR option is available for Standard video mode 4K, 2.7K and 1080p formats (regardless of framerate values) and JPEG photos.

To activate the HDR option, select a Standard video mode or a JPEG photo format from the relevant boxes of the bottom bar of the HUD. A white and round HDR icon appears on the screen of your device, to the left of the photo/video trigger.

Tap this icon: it turns yellow and an HDR notice appears in black inside a yellow box, under the "next available action" box, at the center of the top bar of the HUD. Press the hard shutter button on your Parrot Skycontroller 3 (or the soft shutter button of the HUD) to start filming in HDR or to take an HDR photo.

Tap the round HDR icon again to deactivate HDR. The yellow HDR box disappears from the screen.



Android HDR off



Android HDR on

- ⚠ Note that you cannot modify "s", "ISO" or "WB" values when the HDR mode is activated. However, you always keep control over your EV value.
- ⚠ Note that activating (or deactivating) HDR stops any ongoing video recording.

NATURAL Style

The **Natural** Style is the default **ANAFI** Style: it respects nature's colors and tones.

Activate the "NATURAL" Style from the "Style" box of the Video/Photo settings menu.

P-LOG Style

One alternative Style to Natural looking images (default value) can be selected for **ANAFI** both in the video mode, and in the photo mode. This alternative Style is called "P-LOG". It makes images a little less contrasted: P-LOG style is ideal for videos you want to edit and process using professional grading tools and filters.

Activate the "P-LOG" Style from the "Style" box of the Video/Photo settings menu.

INTENSE Style

Another alternative Style to Natural looking images (default value) can be selected for **ANAFI** both in the video mode, and in the photo mode. It is called "Intense". It makes images more saturated and contrasted.

Activate the "INTENSE" Style from the "Style" box of the Video/Photo settings menu.

ANAFI

PASTEL Style

Another alternative Style to Natural looking images (default value) can be selected for **ANAFI** both in the video mode, and in the photo mode. It is called "**Pastel**". It makes images less saturated, but it brings out their warmest tones.

Activate the "**PASTEL**" Style from the "**Style**" box of the Video/Photo settings menu.

ADJUSTMENT

The **ADJUSTMENT** button, to the right of the **PASTEL** box, provides three additional settings for your **Normal Style** still images and films:

- Saturation: sets the intensity of the colors (from -2 to +2)
- Contrast: sets the degree of difference between lighter and darker parts of the image (from -2 to +2)
- Sharpness: sets the distinction of the reproduction of details (from -1 to +1)



All settings at minimal values (iOS)



All settings at maximal values (iOS)

Tap the **RESET** button, on the right of the screen, to bring all values to 0 (zero).

Tap the "<" icon, on the left of the screen, to confirm your settings and exit the **ADJUSTMENT** menu.

Lock AE

Another great feature of **FreeFlight 6** is the possibility to lock the general exposure of a view, to fine-tune the framing of a shot and keep the desired exposure.

To access this function, tap the "Video settings box" (video mode) or the "Photo settings box" (photo mode) of the HUD.

A "Lock AE" icon appears, to the left of the HDR icon (it replaces the "HDR" icon in DNG+JPEG photo format, since HDR is not available with this setting).

Tap the "Lock AE" icon to lock the exposure value to that of the current view. The icon turns to yellow. A yellow "Lock AE" box appears under the "Next available action" box, at the center of the top bar of the HUD.

Move **ANAFI** around or tilt its gimbal to change the frame: the exposure settings remain as they were when you activated the function.

Tap the "Lock AE" icon again to deactivate the exposure lock: the icon turns back to white and the yellow "Lock AE" box disappears.



Exposure is locked on the sky (Android)

Lock AE Touch

With the “Lock AE Touch” (or “Spot AE”) function of FreeFlight 6, you can also lock the exposure of a frame on any detail of any view.

To activate this function, follow the “Lock AE” procedure of the preceding section. When the exposure is locked, touch the part of the frame you want to base your exposure on. A yellow square animates around this spot and the yellow “Lock AE” box is replaced by a yellow “Lock AE Touch” box.

Refer to the following screen captures for additional details on the logic of this great feature.



Exposure is locked on the top of the trees (Android); shutter speed is set at 1/240 s

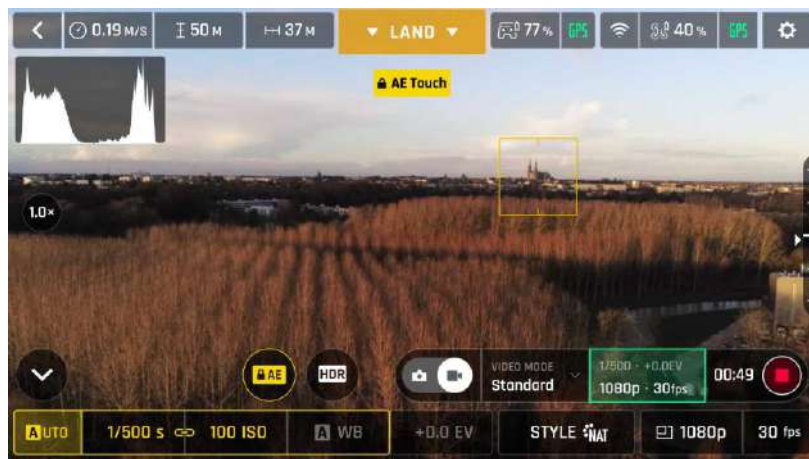

Exposure is locked on a building on the horizon (Android); shutter speed is set at 1/500 s

CINESHOTS

ANAFI features a series of automated shots, which enable you to capture scenes professionally.

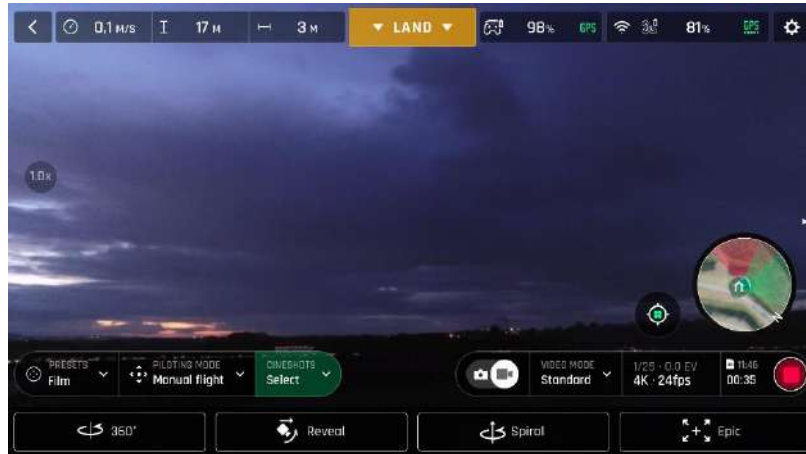

iOS Cineshots Menu

Make sure you have selected the video settings you require and tap “CINESHOTS” in the bottom bar of the HUD to access Cineshots. Tap a Cineshot to select it. For each, two options appear. ANAFI films all your Cineshots automatically – provided you have free space on your microSD card.

360°

The 360° Cineshot is self-explanatory: when it is activated, **ANAFI** maintains its position and altitude, and rotates slowly and completely around its axis to uncover a full panorama.

Tap “Right” or “Left” to select the direction you want your drone to rotate, and to **activate the 360°**. After a countdown on the HUD, **ANAFI** starts its rotation. An animation flashes on the screen of your device, and the “360°” box progressively fills with green as the Cineshot unfolds.

Reveal

The Reveal Cineshot is a classic motion picture opening shot: when it is activated, **ANAFI** tilts its camera toward the ground and starts moving forward in a straight horizontal line. Slowly, over 30 or 60 meters, the camera gimbal tilts up, revealing the scenery in front of **ANAFI**.

Before you activate the Reveal Cineshot, check the area in front of **ANAFI** is clear from obstacles, and safe.

Tap “30m” (small-arrow icon) or “60m” (large-arrow icon) to select the range of your **Reveal shot**, and **activate it**. After a countdown on the HUD, **ANAFI** tilts its camera down and starts moving forward. An animation flashes on the screen of your device, and the “Reveal” box progressively fills with green as the Cineshot unfolds.

Spiral

The Spiral Cineshot is perfect to unveil your surroundings – or that of any object on the ground. When it is activated, **ANAFI** tilts its camera to the ground and starts moving up, in a straight vertical line. Slowly, as it climbs to 30 or 60 meters, **ANAFI** carries out a full 360° rotation around its axis, then and its camera tilts up progressively, panning over the scenery along a 180° rotation. Therefore, **ANAFI** finishes the Spiral Cineshot with a 180° angle, compared to its starting point.

Before you activate the Spiral Cineshot, check the area above ANAFI is clear from obstacles, and safe: do not activate the Spiral Cineshot under trees, or a bridge, for example.

Tap “30m” (small-arrow icon) or “60m” (large-arrow icon) to select the range of your Spiral shot, and activate it. After a countdown on the HUD, **ANAFI** tilts its camera down and starts moving up and rotating. An animation flashes on the screen of your device, and the “Spiral” box progressively fills with green as the Cineshot unfolds.

Epic

The Epic Cineshot offers another great way to dramatize any scene or location. When it is activated, **ANAFI** moves away backward in a smooth ascending line, keeping its subject in the center of its frame for 30 or 60 meters. The Epic Cineshot gives best results when **ANAFI** starts from a close-up position, relative to its subject.

Before you activate the Epic Cineshot, check the area behind ANAFI is clear from obstacles, and safe.

Tap “30m” (small-arrow icon) or “60m” (large-arrow icon) to select the range of your Epic shot, and activate it. After a countdown on the HUD, **ANAFI** starts moving backward and upward. An animation flashes on the screen of your device, and the “Epic” box progressively fills with green as the Cineshot unfolds.

- ⚠ **Activate and monitor all Cineshots with care: always check your automated shot flight plan is clear from obstacles and safe, always retain visual contact with ANAFI, and always be ready to reclaim control of your drone: any action on any stick of Parrot Skycontroller 3 immediately terminates the current Cineshot.**

CONTROL

Tap the "PRESETS" box in the bottom bar of the HUD of **FreeFlight 6** to access the control options, to the right of the preset options.

- ⚠ **Note that the Arcade mode can only be activated when ANAFI is airborne, and under the condition you use both the Parrot Skycontroller 3 and a device to pilot your drone.**
- ⚠ Under the same conditions, you can also activate the Arcade mode through **FreeFlight 6** Preferences - refer to the "*PREFERENCES / Controls*" section of this guide for additional information.

Classic

The Classic control mode is **ANAFI's** default mode. Refer to the following diagram for a reminder of Classic controls.

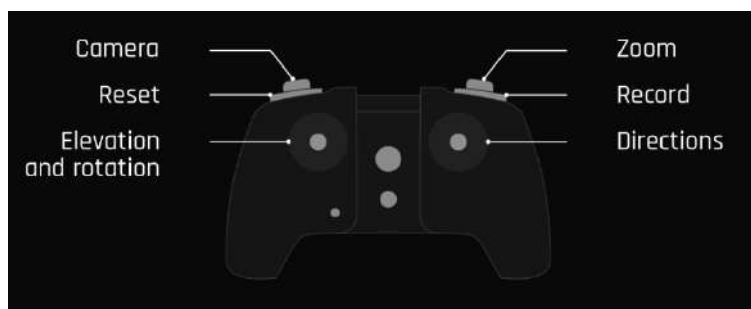

Arcade

The Arcade control mode offers **ANAFI** pilots a whole new piloting experience.

As already mentioned, it can only be activated when ANAFI is flying, but it is available for:

- all piloting modes, including FPV;
- all photo and video modes.

Refer to the following diagram for a reminder of Arcade controls.

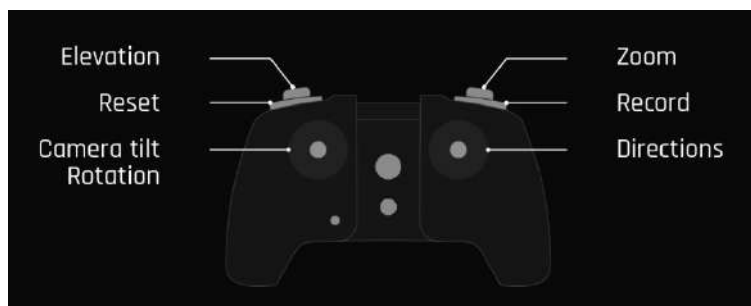

Note that a four-step in-app tutorial guides you through the basic principles of the Arcade mode upon first activation of this feature.

ANAFI

When the Arcade mode is activated:

- a double circle appears at the center of the HUD, which materializes the path of ANAFI;
- the forward command (right joystick forward) makes ANAFI move in the direction pointed by the center of the camera – in other words, for example, when ANAFI's camera is pointing above the horizon line, pushing the right joystick forward makes your drone move forward and up (pulling the right joystick backward makes ANAFI move backward and down);
- the tilt of the camera (up or down) and the general direction of the drone (left or right) are controlled by the left joystick;
- the elevation of ANAFI can be controlled and compensated with the left trigger of the Parrot Skycontroller 3;
- activate the minimalist HUD mode by pinching the screen between two fingers (pinch the screen again to revert to normal Arcade HUD).



Android Arcade mode HUD view



Android Arcade mode, minimalist HUD view

- ⚠ Note that the Arcade mode deactivates automatically when:
- **RTH is activated**, either manually or after a disconnection;
 - **ANAFI is landing**;
 - your device is disconnected from your Parrot Skycontroller 3.

PILOTING MODES

Tap the “PILOTING MODE” box in the bottom bar of the HUD of **FreeFlight 6** to access the piloting modes options.

Tap a mode to select it. Each mode is associated with a specific behavior, which this section describes.

Manual flight

The Manual flight mode is **ANAFI**'s default mode. It enables you to pilot the drone and fully control its camera tilt and zoom.

When you release the commands in Manual flight mode, **ANAFI** stays in position, hovering.

Cameraman

The Cameraman mode enables you to keep an object or a subject in the center of your frame, while you pilot **ANAFI** around it/him/her.

Frame the object or subject you want to film and fly around.

Tap the “PILOTING MODE” box in the bottom bar of the HUD to access the options. Tap “Cameraman” to select this piloting mode.

Draw a rectangle with your finger on the screen of your device, around the object or subject you want **ANAFI** to follow – or double tap this object or subject. When your target is locked, the blue rectangle turns to green and the orange “LAND” box at the center of the top bar of the HUD turns red and displays “STOP”. **ANAFI**'s frame centers on your target, inside the green box.

Drag the green box to the area of the frame where you want your target to remain at.

Fly **ANAFI** around your target. The drone keeps your target in the part of the frame you have selected. Therefore, if you push the right joystick of the **Parrot Skycontroller 3** to the left, **ANAFI** circles around your target clockwise. If you push the right joystick of the **Parrot Skycontroller 3** to the right, **ANAFI** circles around your target counterclockwise.

When the Cameraman mode is activated, **ANAFI** manages the gimbal tilt to keep the target in the frame. Therefore, the left trigger of the **Parrot Skycontroller 3** is deactivated in this mode. However, you can still control the zoom, with the right trigger.

When you release the commands in the Cameraman mode, **ANAFI** hovers and rotates to keep following the target.

ANAFI

To end the following of your target, tap the red "STOP" box at the center of the top bar of the HUD.

When no target is selected, or when the following of the target has been ended by the pilot, ANAFI's behavior is similar to that of the Manual flight mode.

- ⚠ **Activate and monitor the Cameraman mode with care: always check your flight plan and the trajectory of your subject are clear from obstacles and safe, always retain visual contact with ANAFI, and always be ready to stop the following (tap the "STOP" box of your HUD) in case a danger or any sort of unexpected obstacle arises.**

Follow Me (in-app purchase)

The Follow Me mode was designed to enable ANAFI pilots to have their drone follow them in action. It must be purchased from the Google (Android) or Apple (iOS) stores to be activated.

Fly ANAFI at least 5 meters (15ft) high and 10 meters (30ft) in front of you, facing you – FreeFlight 6 will inform you with a red alert at the bottom of the HUD if you are too close from ANAFI or if it is flying too low.

Frame yourself.

Tap the "PILOTING MODE" box in the bottom bar of the HUD to access the options. Tap "Follow Me" to select this piloting mode.

Both a drone GPS synchronization and a device GPS synchronization are imperative to activate this mode: upon first activation, the following page appears.



iOS, Follow Me GPS warning

Tick the box on the bottom left on the page if you do not want this warning to appear again when no prerequisite is missing. Tap "FLY" to access the Follow Me mode.

Select one of the three Follow Me options (refer to in-app explanations for details):

Track

Lock

Dynamic (Parrot recommends you only use this option in completely open and unobstructed areas)

Draw a rectangle with your finger on the screen of your device, around yourself. When **ANAFI** has a lock on you, the blue rectangle turns to green and the orange “LAND” box at the center of the top bar of the HUD turns red and displays “STOP”.

By default, **ANAFI** keeps you in the center of the frame, but you can drag the green box to the area of the screen you want to remain at. If you push the right joystick of the **Parrot Skycontroller 3** to the left, **ANAFI** circles around you clockwise. If you push the right joystick of the **Parrot Skycontroller 3** to the right, **ANAFI** circles around you counterclockwise.

In the Follow Me mode, **ANAFI** manages the gimbal tilt to keep you in the center of the frame. Therefore, the left trigger of the **Parrot Skycontroller 3** is deactivated in this mode. However, you can still control the zoom, with the right trigger.

When you release the commands in the Follow Me mode, **ANAFI** keeps following you from a constant distance if you are moving. If you stay immobile, **ANAFI** stops and stays focused on you.

To have **ANAFI** stop tracking you, tap the red “STOP” box at the center of the top bar of the HUD.

When no target is selected, or when the tracking has been ended by the pilot, **ANAFI**'s behavior is similar to that of the Manual flight mode.

In addition, the Follow Me mode features a series of exclusive Dronies which can be activated as you move, always keeping you in the center of the frame. For each Dronie, two options are available (they are listed between brackets):

Orbit (left or right):	ANAFI circles around you in a full 360°.
Parabola (10 or 30 m):	ANAFI flies in a circular arc over your head, gaining 10 or 30 meters in altitude and turning 180° at its peak.
Tornado (10 or 30 m):	ANAFI performs a double “Orbit” around you, one going up 10 or 30 meters, the other going down 10 or 30 meters, back to its original height.
Boomerang (30 or 60 m):	ANAFI flies away from you for 30 or 60 meters, with an ascending angle following that of the starting gimbal tilt, then comes back to its starting point.

To select a Follow Me Dronie, make sure you are in the Follow Me mode and that **ANAFI** is tracking you.

Tap the “Select Dronie” box in the bottom bar of the HUD.

Tap a Dronie to select it. Tap the option you have chosen to activate the Dronie: after 2 seconds, **ANAFI** starts moving around you. The corresponding Dronie box fills with green as the Dronie unfolds.

- ⚠️ Activate and monitor the Follow Me mode and each Drone with care: always check your flight plan is clear from obstacles and safe, always retain visual contact with ANAFI, and always be ready to stop the following (tap the "STOP" box of your HUD) in case a danger or any sort of unexpected obstacle arises.
- ⚠️ To optimize the drone's tracking, always make sure you remain visible by ANAFI: do not let an obstacle obstruct the camera's view and do not hide in the shadows, or ANAFI could lose track of you.

Smartdronies

ANAFI features four Smartdronies:

- the **Orbit**, **Parabola** and **Boomerang** Drone can be accessed through this menu - refer to the above section for details about these Smartdronies;
- however, the smartest of ANAFI's dronies is the **Dolly Zoom**.

We will not spoil it for you: just make sure you have a memorable scenery behind you. Frame yourself (or better yet, your group of friends!) with ANAFI: keep the drone at least 5 meters away, at man level, between 1 and 2 meters above the ground.

Check that the flight path of your drone is perfectly clear: at least 30 meters behind it, flat and without obstacles.

Tap "Smartdronies" from the "PILOTING MODE" box menu.

As for the Follow Me mode, both a drone GPS synchronization and a device GPS synchronization are imperative to activate this mode: upon first activation, the same warning page appears as for the Follow Me mode. Tick the box on the bottom left on the page if you do not want this warning to appear again when no prerequisite is missing. Tap "FLY" to access the Smartdronies mode.

Tap the Dolly Zoom Drone to open its three options: try them all and enjoy the magic!

FPV FLYING MODE

FPV presentation and activation

ANAFI can be flown in FPV (first-person view) mode – otherwise known as immersive flight – using the **Parrot Cockpitglasses 3** or any compatible FPV goggles – refer to the *“PREFERENCES / Interface”* section of this guide for a list of compatible FPV goggles.

- ⚠ **Parrot reminds you many national regulations forbid full immersive flights (drone pilots wearing FPV goggles themselves) outside of designated or private flight zones (secured drone circuits, warehouses, etc.).**
However, the FPV mode of ANAFI always lets you take a friend for a flight, as a virtual passenger. So do not hesitate in sharing the flying thrill!
- ⚠ **Always activate and use the FPV mode with extreme care.**
- ⚠ **Use great precision to position your device inside the FPV goggles, as only precise and careful positioning ensure a perfect viewing comfort.**
- ⚠ **Only the Parrot Cockpitglasses 3 offer full “goggles on” compatibility with all ANAFI’s FPV features.**

Obviously, the FPV mode is only available when both your **Parrot Skycontroller 3** and your device are connected to ANAFI.

1. **If you intend to record Standard videos in FPV mode, remember to set a resolution and a framerate from the HUD menus** before you activate the FPV mode, as these options are not available through “goggles on” FPV settings.
2. **If you intend to fly with the Geofence activated, remember to set maximum distance and altitude for ANAFI from the HUD menus** before you activate the FPV mode, as these options are not available through “goggles on” FPV settings.
3. If you are **NOT** using **Parrot Cockpitglasses 3**, Parrot also recommends you set up your flight and filming or photography options before you activate the FPV mode and install your device inside your FPV goggles.
4. Activate the FPV mode through the corresponding box on the homepage of **FreeFlight 6**, or through the Piloting mode box, bottom left of the HUD: tap “FPV” to activate the immersive flight mode.

5. Upon first activation of the FPV mode, a dialog invites you to select the brand and model of your FPV goggles (default value: **Parrot Cockpitglasses 3**).

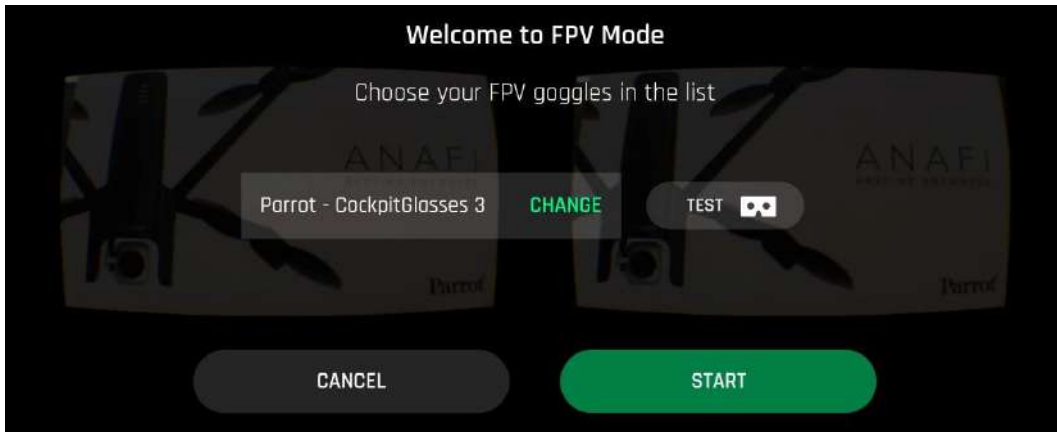

6. Tap "START". The HUD appears split in two identical half-screens and a dialog reminds you how to open the FPV settings, depending on the model of your FPV goggles.
7. Activate any control of the **Parrot Skycontroller 3** to exit this dialog.
8. If you had not installed your device inside your FPV goggles at this stage, do it now and enjoy FPV flying!

⚠ Even if your FPV goggles have no capacitive button, note that while in FPV mode, you can always open the FPV settings with a touch, anywhere on the screen of your device – refer to the "*FPV settings*" section of this guide for additional details.

FPV HUD

As you can see on the following screen capture, the standard FPV HUD interface of **FreeFlight 6** displays most information available on the regular HUD – only half of the actual screen capture is presented here, for improved readability.



iOS, FPV HUD

The main differences between the regular HUD and the FPV HUD are:

- both **Parrot Skycontroller 3's** and device's battery levels are shown on the FPV HUD's top bar;
- the tilt of the gimbal is materialized by the white dot inside the vertical bar, on the right side of the screen of the FPV HUD;
- a green drone icon appears on the compass bar, top of the FPV HUD, and materializes the position and direction of **ANAFI**.

See-through FPV view

As already mentioned, since the **Parrot Cockpitglasses 3** were specially designed for ANAFI's FPV mode, only this two-button goggles model is fully compatible with all FPV features of **FreeFlight 6**.

Use the **bottom capacitive button** of the **Parrot Cockpitglasses 3** to toggle between drone and **see-through** (device) views – with single-button or buttonless FPV goggles, the see-through view can be activated through the FPV settings: refer to the next section of this guide for details.

The **see-through** view notably enables you to easily and accurately localize your **ANAFI**, thanks to an augmented reality green drone icon (or red altitude and azimuth indications, as in the half-screen capture which follows).



iOS, FPV see-through HUD: the device must be pointed toward the south to find ANAFI

- ⚠ Be especially careful with the controls of the Parrot Skycontroller 3 when the see-through view is activated, as these controls remain fully active.

FPV settings

Parrot Cockpitglasses 3 were specially designed for **ANAFI**'s FPV mode. In consequence, only this two-button goggles model is fully compatible with all FPV features of **FreeFlight 6**.

Use the **top capacitive button** of the **Parrot Cockpitglasses 3** to open the **FPV settings menu** of **FreeFlight 6** - the button of single-button FPV goggles also opens the FPV settings menu; if you use a set of buttonless FPV goggles, open the FPV settings menu with a tap anywhere on the screen of your device.

- ⚠ As **ANAFI** remains in hover mode while you navigate the FPV settings menu with the **Parrot Skycontroller 3**, it is essential that you fly your drone to a perfectly safe location, well distant from any obstacle or moving object, before you open the FPV settings menu.

Use one of the joysticks of the **Parrot Skycontroller 3** to navigate through the menus.

Navigate all the way upward to activate the **see-through view** (single button or buttonless FPV goggles).



Android FPV settings

Use the (top) capacitive button (**Parrot Cockpitglasses 3**) or touch the screen to confirm your settings, exit to FPV view and regain control of **ANAFI**.

There are three series of FPV settings: Interface, Camera, Equipment. Some conditional menu items open sub-options: those are listed below, between brackets.

Interface settings

Here are the parameters you can change through the Interface settings:

- Speed: Film / Sport / Cinematic / Racing
- Interface: Standard / Minimalist
- Piloting style: Classic / Arcade
- Geofence: Yes / No

Camera settings

Here are the parameters you can change through the Camera settings:

- Selector on Photo: Single / Timer (3 to 10s) / Burst/ Bracketing (3 to 7 photos) / Panorama (Horizontal, Vertical or 360) / Timelapse (5 to 120s) / GPS Lapse (5 to 200m)
- Selector on Video: Standard / Cinema / Hyperlapse (x15 to x240) / Slow Motion (x0.25 or x0.5) / High Framerate
- HDR: On / Off
- Display overexposure: Yes / No
- Imaging settings: Auto / Pro (refer to the *"Pro-imaging settings"* section of this guide for details on Pro settings)

Equipment setting

Select your equipment from this list of compatible FPV goggles:

- | | | |
|----------------------------------|---|---------------|
| Parrot – CockpitGlasses 1 | / | Homido |
| Parrot – CockpitGlasses 2 | / | Merge VR |
| Parrot – CockpitGlasses 3 | / | BNext |
| Google – DayDream View | / | Skillkorp VR5 |
| Homido V2 | / | Zeiss VR One |
| Homido Prime | | |



MAP-BASED FLYING MODES

Flight Plan (in-app purchase)

Flight Plan is a powerful tool, which enables you to fully prepare and configure your flights and filming sessions, from home, on the train, in a plane, or anywhere else you can take your phone with you.

Through an example, this section will teach you the basics of automated flight and shooting management, with ANAFI and Flight Plan.

Tap **Flight Plan** from the “PILOTING MODE” box menu. The map of your surroundings opens full screen. If you are not connected to **ANAFI**, the minimized live view is black, as on the screen captures that follow. Find your next dream flying spot on the map.

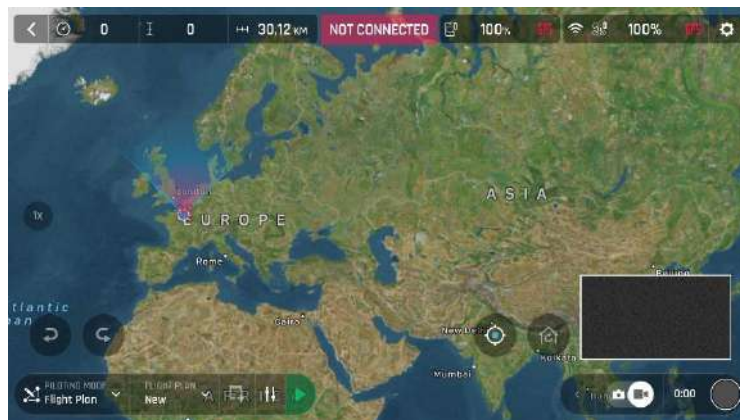

iOS Flight Plan

Consider this pointy bit of land, with a lighthouse in the middle. Say you could fly **ANAFI** and shoot a film there. Let's do it!

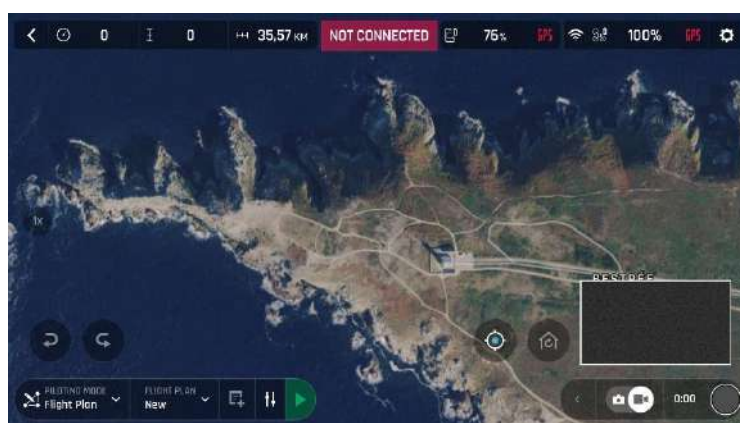

iOS: new Flight Plan

ANAFI

First, select your initial waypoint: ideally, very close to your intended take-off point. Tap the screen to set it. The green circle represents the waypoint, the white figure the altitude of the drone, and the white arrow the direction of ANAFI's camera.

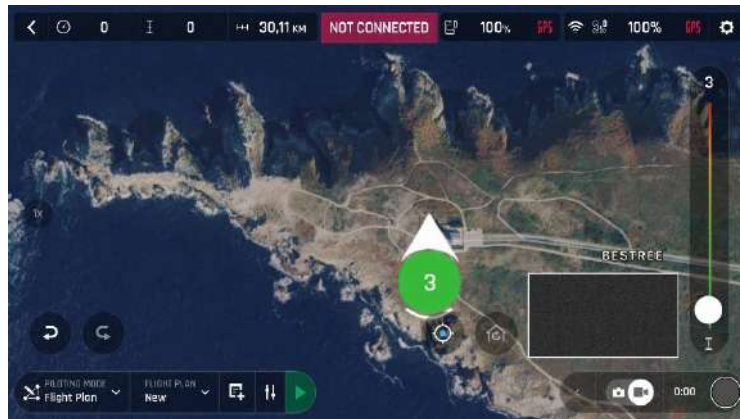

iOS: initial waypoint

Tap the white arrow and hold it to move it around. In this example, we want ANAFI to frame the lighthouse as it starts the flight.

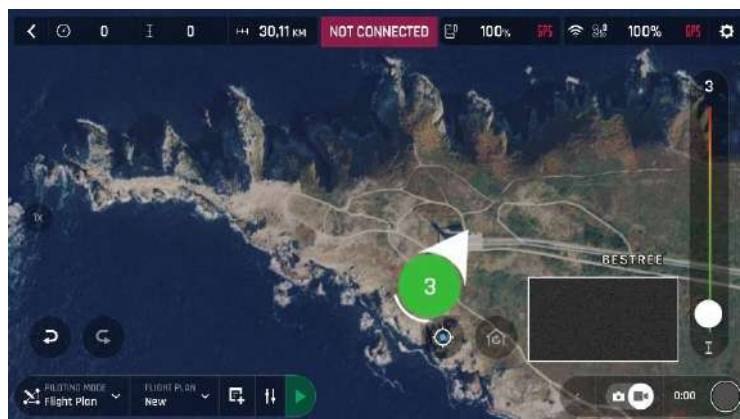

iOS: initial waypoint, with the camera framing the lighthouse

Tap the map to set the second waypoint: the distance between the two waypoints appears on the screen. Use the slider on the right of the screen to set the altitude of the waypoint. In this example, ANAFI will climb from 3 to 30 meters between the initial waypoint and the second waypoint.



iOS: second waypoint

Add waypoints to tour the area and end your Flight Plan where you intend to land.



iOS: full Flight Plan

The tip of the peninsula is a POI: we want ANAFI to focus on it while it flies around it. Tap it and hold your finger on the screen to call choices (POI/Close).



iOS: setting a POI

Tap "Point of interest" to add the POI. It appears as a blue square diamond. The figure in the center represents the height of the POI, which you can modify using the slider on the right of the screen. All waypoints turn white as they can now be selected to be linked to the POI.

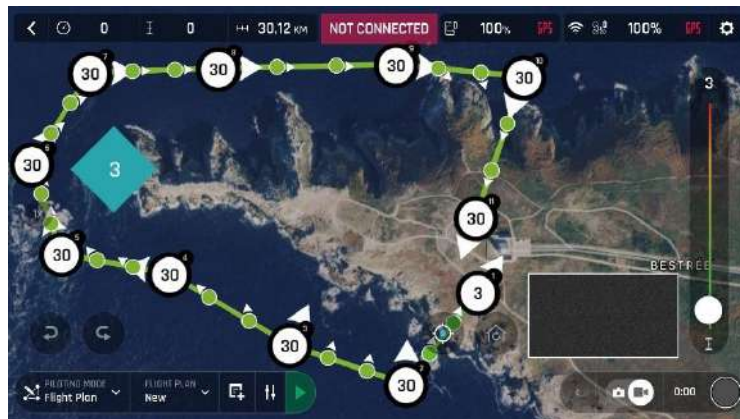

iOS: open waypoints

Tap waypoints to link them to the POI. In this example, we want ANAFI to film the tip of the peninsula as it flies around it: we have selected the three waypoints to the left of the peninsula. The arrows of those waypoints have turned toward the POI and are colored in blue - the last one which was selected has a blue border around the white arrow.



iOS: three waypoints linked to the POI

Tap the POI to confirm your choices. Blue waypoints are linked to the POI, which appears as a white square diamond with a blue border. During the entire blue part of the flight, **ANAFI's** camera will stay focused on the tip of the peninsula, enabling you to achieve the smoothest flyby shoot. Green waypoints remain independent from the POI.



iOS: POI Flight Plan

Tap a green waypoint to edit it: use the slider on the right of the screen to modify its height; tap and move its white arrow to set the direction of **ANAFI's** camera. For this example, we had the drone point toward the land at most steps of the Flight Plan, and toward the lighthouse at take-off and landing, with a descent from 30 to 3 meters between the last two waypoints.



iOS: POI Flight Plan

All you have to do now is to close **FreeFlight 6**, to get to your flying spot, to prepare **ANAFI**, your **Parrot Skycontroller 3** and your device for the flight.

Tap the "PILOTING MODE" box on the HUD to call the options. Select "Flight Plan": the last plan you have set up appears.

ANAFI

Tap the green arrow on the right of the left bottom bar of the Flight Plan interface to begin the Flight Plan: ANAFI takes off, flies to the first waypoint and starts the Flight Plan. At the end of the Flight Plan, depending on your settings and depending on your version of FreeFlight 6, ANAFI lands at, or hovers over, the last waypoint you have set.

That is why, for this section, we have chosen to consider that ANAFI's final waypoint is also its landing spot.

- ⚠ **Activate and monitor every Flight Plan with extreme care: always check your drone's route is clear from obstacles and safe, always retain visual contact with ANAFI, and always be ready to stop the Flight Plan (tap the "STOP" box of your HUD or reclaim commands of the drone) in case a danger or any sort of unexpected obstacle arises.**

Touch & Fly: Waypoint

Waypoint is the default “Touch & Fly” mode. It enables you to fly **ANAFI** to any point on the map. Tap “Touch & Fly” from the “PILOTING MODE” box menu. The map of your surroundings opens full screen. The live image captured by **ANAFI** is minimized in the bottom right corner of your screen.

Tap a point on the map to select a destination for ANAFI: this point is marked as a white circle with a green border. For each new Waypoint Touch & Fly session, **FreeFlight 6** asks you to confirm the first destination of **ANAFI** as on the following screen capture. Tap the green “TAP HERE TO START” box, **ANAFI** flies toward its designated destination. Use the slider on the right of the screen to control the drone's altitude (the green figure inside the circle) when it reaches its destination.

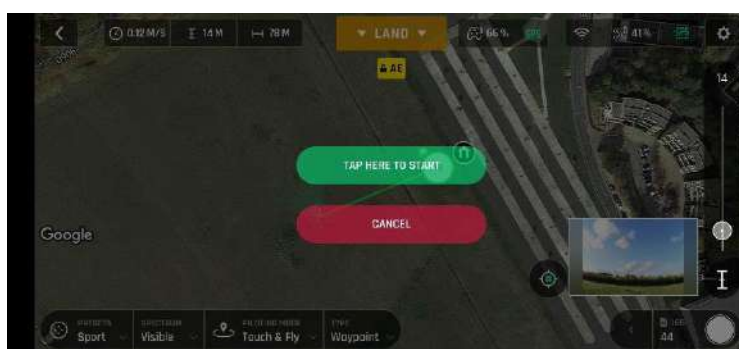

Android Touch & Fly Waypoint: first destination confirmation screen

- ⚠ **Activate “Touch & Fly” Waypoint with care:** be especially careful with your touches on the screen in this mode, as after the initial confirmation, any tap on the map will immediately send **ANAFI** to the corresponding spot.

For this reason, Parrot recommends you set your **FreeFlight 6** filming or photography options **before** activating the “Touch & Fly” Waypoint mode.

If, by mistake, you have sent **ANAFI** toward a dangerous area, tap the STOP box at the center of the top bar of the HUD, or firmly reclaim commands from the **Parrot Skycontroller 3**.

Touch & Fly: POI

To access the POI Touch & Fly option, tap the “Type” box from the lower bar of the HUD, and select POI.

In POI mode, tap a point on the map to create a point of interest (POI), marked as a white square diamond with a blue border, labelled with a POI icon. Control the height of the POI (the blue figure inside the square diamond) through the slider on the right: this effectively controls the tilt of the gimbal, while you use the **Parrot Skycontroller 3** to fly around your target. **ANAFI** remains focused on the POI.



Android Touch & Fly: POI

Tap "STOP" from the red box at the center of the top bar of your screen to halt ANAFI, or to reset a POI.

From the "Smartdronies" box, next to the "Type" box of the lower bar of the HUD, you can also activate Smartdronies (**Orbit**, **Parabola**, **Dolly Zoom**, **Boomerang**) of your POI.

Refer to the "*Smartdronies*" section of this guide for additional information on Smartdronies types.

If you have feedback or comments about the v2.6.2 of this user guide, please reach out to:

technical.writer@parrot.com