

HE
HEYGELO



V1.01
S90

USER MANUAL

14+
AGES

www.heygelo.com

usa@heygelo.com

eu@heygelo.com

» 1.0 DISCLAIMER AND SAFETY GUIDELINES

- ① DO NOT look directly into the drone light.
- ② DO NOT treat the product as household waste.
- ③ DO NOT fly above or near obstacles, crowds, open water, public road, high voltage power lines or trees.
- ④ DO NOT use the drone in severe weather conditions. These include wind, snow, rain, smog, hail, lightning, tornadoes or hurricanes.
- ⑤ Stay away from the rotating propellers and motors to avoid some tiny objects (e.g. hair) to get into them.
- ⑥ This drone does not come with GPS module. Please fly the drone within the control range.
- ⑦ Be sure to observe all local regulations, obtain appropriate authorizations and understand risks. Please note it is solely your responsibility to comply with all flight regulations.

Heygelo accepts no liability for damage, injury or any legal responsibility incurred directly or indirectly from the use of this product. The user shall observe safe and lawful practices including, but not limited to, those set forth in these Safety Guidelines. **Heygelo** reserves the right to update this user manual.

» 2.0 MAINTENANCE AND CARE

- ① Thoroughly check the drone after crash or violent impact.
- ② Do not charge battery before it cools down.
- ③ Remove the batteries if the product will not be in use for a long time.
- ④ Do not over charge the battery. Unplug the charger once it's fully charged.
- ⑤ Store the drone and remote in a cool, dry place away from direct sunlight.
- ⑥ Do not charge the battery next to inflammables, such as carpet, timber floor etc., or on the surface of electro-conductive objects. Please always keep an eye on the battery while charging.
- ⑦ Please use the original battery provided. Use an incorrect type of battery may lead to fire hazards.
- ⑧ Do not dispose of the battery in fire or a hot oven, cut or mechanically crush the battery, as this may cause explosions.
- ⑨ Do not leave the battery in an extremely high-temperature environment that can result in an explosion or the leakage of flammable liquid or gas.
- ⑩ Do not expose the battery to the extremely low air pressure, as this may result in an explosion or the leakage of flammable liquid or gas.

» 3.0 SAFETY GUIDELINES

3.1 Check Before Use.

- ① This product is a high precision drone that integrates various electronic stability and control mechanisms. Please be sure to configure this drone carefully and correctly to ensure safe, accident-free operation.
- ② Ensure that the batteries of the drone and transmitter are clean, undamaged and fully charged before every use.
- ③ Ensure that all the propellers are undamaged and are installed in the correct orientation.
- ④ Ensure to do a thorough check of the product before each use. Inspect the integrity of the parts, any signs of cracks and wear of the propeller, battery power and effectiveness of the indicator, etc. If after doing a complete check of the drone any problem are found, please refrain from using it until the problem has been resolved.

3.2 Flight Environment



Fly in Open Areas

Maintain Line of Sight

Fly Below 98 feet (30m)



Avoid flying over or near obstacles, crowds, high voltage power lines, trees, airports or bodies of water.

DO NOT fly near strong electromagnetic sources such as power lines and base stations as it may affect the onboard compass.



DO NOT use this drone in adverse weather conditions such as rain, snow, fog and wind.

» 4.0 PRODUCT OVERVIEW

4.1 Transmitter

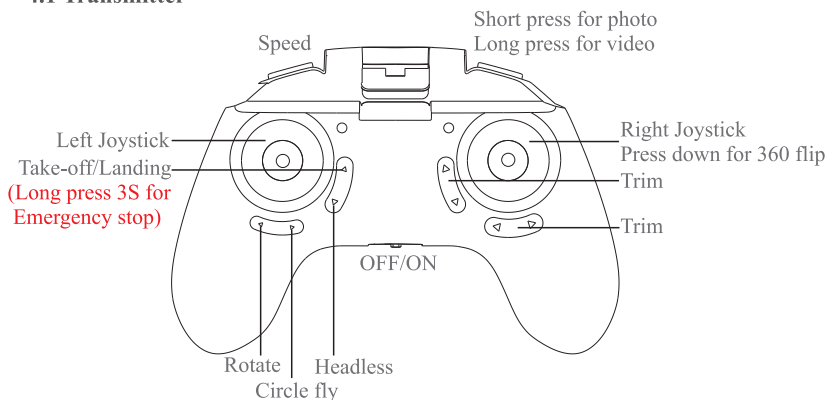

4.2 Propellers

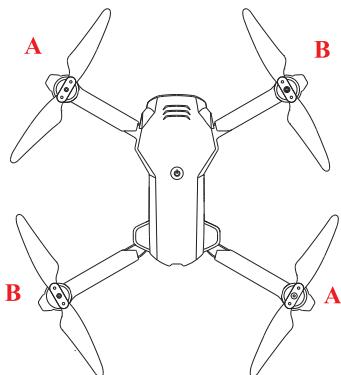

Connect each propeller to its corresponding motor shaft, either position 'A/B', then lock the propeller to the motor shaft with a screw.

⚠ Pay attention to the 'A' or 'B' printed on the each propeller. The drone will not fly unless the correct propeller is installed on the correct motor shaft.

» 5.0 FLIGHT PREPARATION

- ① Install the remote batteries.

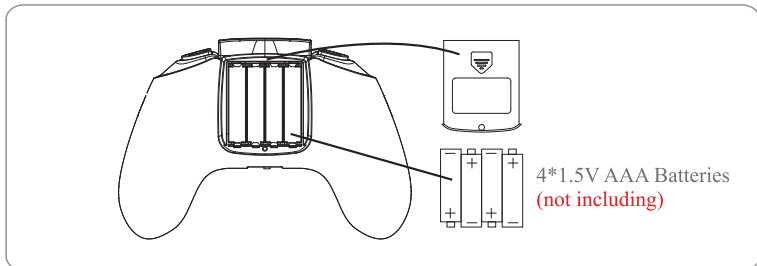

- ② Charge the battery of the drone.

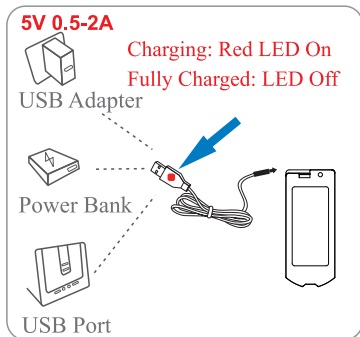

- ③ Install the drone battery after it's fully charged.

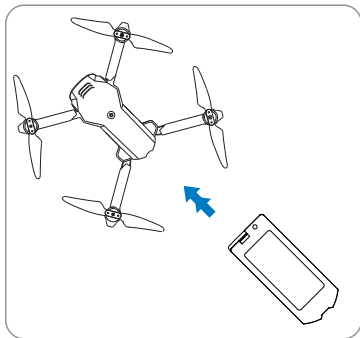

Tips:

- ① **For your safety, please use the original battery and USB cable.**
- ② If use fast charge, the electric current may increase sharply and the rubber part may melt.
- ③ Plug the USB charging cable into a USB charging port on the computer, power bank or USB adapter(5V/0.5-2A).
- ④ Free the battery of any sharp objects that could puncture into the battery to avoid risks of explosions and fire.
- ⑤ There is continuous beeping sound from the remote when the battery of the remote is low.
- ⑥ **The LED on the drone will flash quickly when the battery of the drone is low. About 30 seconds, the drone will land automatically.**
- ⑦ To extend the battery's lifespan, recharge it at least once every three months if not using it for long periods of time.

» 6.0 FLIGHT OPERATION GUIDE

6.1 Pairing

① Long press the power switch to turn on the drone, the indicator light of the drone will keep flashing.

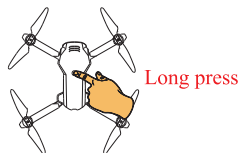

② Place the drone on a flat and level surface with the head forward and the tail facing towards the pilot.

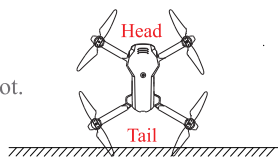

③ Turn on the transmitter, and you will hear the 'DiDi' sound, then the indicator lights keep flashing.

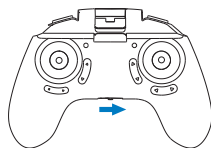

④ Push the throttle joystick up then down to pair the drone with the transmitter. The indicator light on the drone will turn solid if the drone is paired successfully.

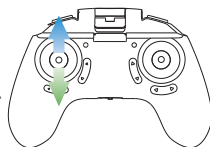

6.2 Calibrate the Gyro

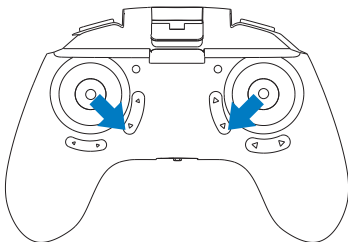

Push two levers down to 45° as picture shows, the indicator light on drone will blink and turn solid that indicates the calibration is completed.

⚠ To ensure a stable flight, we suggest that the pilot calibrates the gyro every time after pairing the drone and after a crash.

6.3 Unlocking / Locking the motors

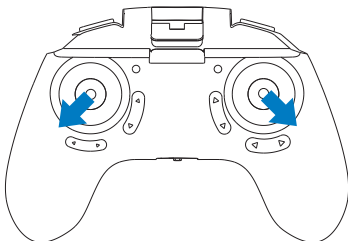

Unlocking the motors: As the show above,move the Left Control Stick to lower left in 45° and the Right Control Stick to lower right in 45° at the same time until four rotor blades start rotating.

Locking the motors: Repeat this operation, the motors will stop immediately.

6.4 One key take-off / Landing

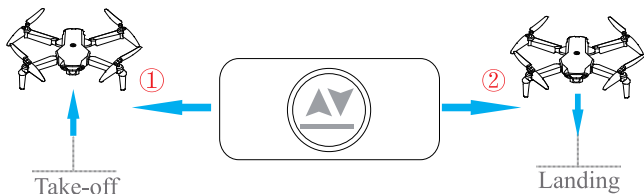

- ① After pairing/calibration, press the One Key Take-Off button, the drone will take off automatically and hover at 5 feet altitude.
- ② When the drone is flying, press the One Key Landing button again, the drone will land on the ground automatically.

6.5 Emergency Stop

- ⚠** The Emergency Stop function should only be used in case of emergency during the flight to avoid any of damage or injury.

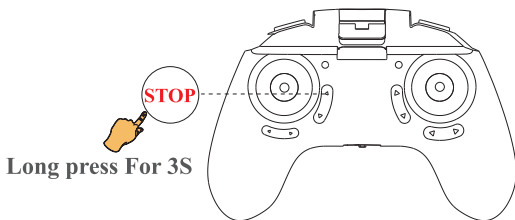



As shown above, long press the Emergency Stop button for 3 seconds, the drone will fall rapidly.

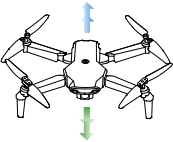
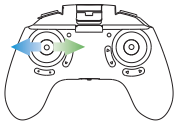

Attention: Be aware that you risk breakage of the drone if it falls a large distance or hits anything at a high rate of speed.

6.6 Instructions of the Remote

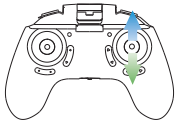

6.6.1 Left Control Stick

<p>Ascend / descend</p> 		<p>Push the Left Control Stick forward and the drone will ascend; pull it backward and the drone will descend.</p>
<p>Rotate Left / Rotate Right</p> 		<p>Push the Left Control Stick leftward and the drone will rotate to the left; pull it rightward and the drone will rotate to the right.</p>

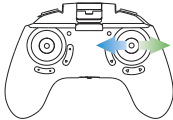
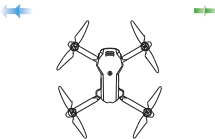
6.6.2 Right Control Stick

<p>Forward / Backward</p> 		<p>Push the Right Control Stick forward and the drone will fly forward; pull it backward and the drone will fly backward.</p>
<p>Leftward / Rightward</p> 		<p>Push the Right Control Stick leftward and the drone will fly leftward; pull it rightward and the drone will fly rightward.</p>

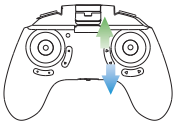
6.6.3 Flight Trimming

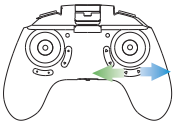
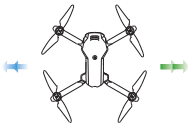

		<p>If the drone drift forward or backward when hovering, press the Backward Trim button or the Forward Trim button to adjust.</p>
		<p>If the drone drift leftward or rightward when hovering, press the Rightward Trim button or the Leftward Trim button to adjust.</p>

6.7 Altitude Hold / Hover

This is one of the default setting in the drone. When you release the Left Control Stick after the ascending/descending action, the drone will hover at the current flight height. For a stable flight, press the trim buttons to adjust accordingly.

6.8 Headless Mode

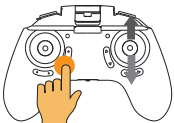
Press the Headless button to activate the function. In this mode, the drone will fly following the direction of the Right Control Stick regardless of the position of your drone's head or the tail. The LED on the drone will flash and there is beeping sound from the remote. Press the same button again to exit this mode.

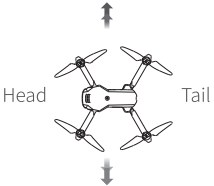
<p>Forward</p>  <p>Backward</p>	<p>Head</p>  <p>Tail</p>	 <p>Head</p> <p>Tail</p>
<p>Standard Mode</p>		<p>Headless Mode</p>

6.9 360° Flip

After flying the drone to a height over 2 meters, press down the right joystick to activate 360° flip function. Then move the Right Control Stick forward/backward/leftward/rightward to flip the drone accordingly.

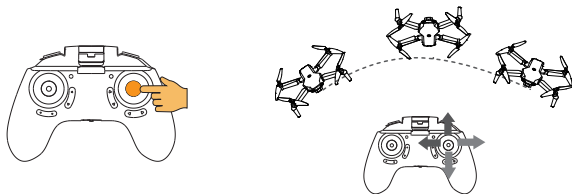

⚠ This function can't be activated when the battery of the drone is low.

6.10 Speed Switch

The drone is set to low speed by default. Press the Speed button down once for medium speed and there are two beeps from the remote. Press it down again for high speed and there are three beeps from the remote. A third press will get back to low speed and there is one beep from the remote.

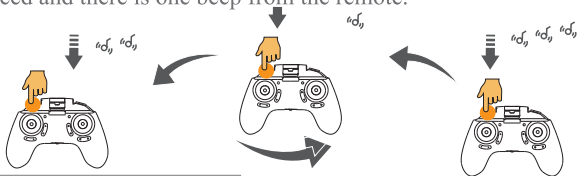

Speed	mph	km/h	m/s
Low	1-3	1-5	0.3-1.5
Mid	4-7	6-11	1.6-3.3
High	8-12	12-19	3.4-5.4

⚠ When you fly in high wind, please use the high speed to control your drone.

6.11 High-Speed Rotation

Press the  button to make the drone rotate at high speed. Press the button again to exit this mode.

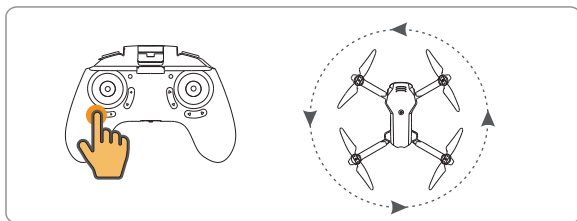

6.12 Circle Fly

Ensure that there are no obstacles within a radius of 5 meters around the drone. Press the  button, and the drone will fly in circles. Press the button again to exit this mode.

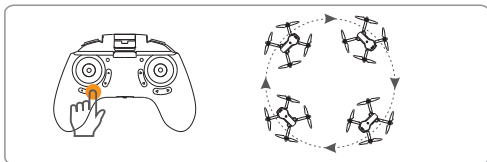

6.13 App Operation Guide

- 1 Download and install **Heygelo Sirius** into your mobile device from **App Store / Google Play** or scanning the QR code below.



For Android 4.4 or later



For IOS 9.0 or later

- 2 Turn on the drone first, go to the WIFI settings of your mobile device and connect to the wifi **HEYGELO_S90_*****
- 3 Open **Heygelo Sirius** App. Tap **Start** for video viewing surface.



NOTE:

- 1 If you want to fly the drone with the controller, then turn on the drone and controller for pairing together first.
- 2 To fly the drone with App, pair the drone with the app first, then you can use the smart phone to control the drone flying.

SPECIFICATIONS

Drone	
Model Number	S90
Item Weight	115g/4.06oz
Operating Temperature	32°F to 104°F (0°C to 40°C)
Flight Time	10~11 minutes (per battery)
Battery	
Capacity	1200mAh
Voltage	3.7V
Battery Type	Li-Po battery
Charging Temperature Range	41°F to 104°F (5°C to 40°C)
Charging Time	90-100 minutes (Depends on charging power)
Transmitter	
Operating Frequency	2.4GHz
Max Flight Distance	262-328 feet/80-100m (Outdoors and unobstructed)
Operating Temperature Range	32°F to 104°F (0°C to 40°C)
Battery Type	4*1.5V AAA battery (Not included)
Camera	
Operating Frequency	2.4GHz
Photo Resolution	HD 1920*1080
Video Resolution	HD 1280*720
Max Transmission Distance	197feet/60m (Outdoors and unobstructed)
Operating Temperature	32°F to 104°F (0°C to 40°C)
USB Charging Cable	
Input	5V/0.5-2A
Output	5V/1A
Rated Power	≤ 10W

FCC Caution:

This device complies with Part 15 of FCC Rules. Operation is subject to the following two conditions:(1) this device may not cause harmful interference, and (2) this device must accept any interference received, including interference that may cause undesired operation.

Warning! Any changes or modifications not expressly approved by the party responsible for compliance could void the use's authority to operate the equipment.

NOTE: This equipment has been tested and found to comply with the limits for a Class B digital device, pursuant to part 15 of the FCC Rules. These limits are designed to provide reasonable protection against harmful interference in a residential installation. This equipment generates, uses and can radiate radio frequency energy and, if not installed and used in accordance with the instructions, may cause harmful interference to radio communications. However, there is no guarantee that interference will not occur in a particular installation. If this equipment does cause harmful interference to radio or television reception, which can be determined by turning the equipment off and on, the user is encouraged to try to correct the interference by one or more of the following measures:

- Reorient or relocate the receiving antenna.
- Increase the separation between the equipment and receiver.
- Connect the equipment into an outlet on a circuit different from that to which the receiver is connected.
- Consult Customer Service or an experienced radio/TV technician for help.

Manufacturer

Guangzhou Mashanghe Information Technology Co., Ltd.

Address: Room C308, No.7 Songgang Street, Cencun, Tianhe District,
Guangzhou, China

WARRANTY

Heygelo Drone makes every effort to assure that the products meet high quality and durability standards, and warrants to the original purchaser that this product is free from defects in materials and workmanship for the period of 90 days from the date of purchase.

This warranty does not apply to damage due to directly or indirectly misuse, abuse, negligence or accidents, repairs or alterations outside our facilities, criminal activity, improper installation, abnormal wear and tear, or lack of maintenance. We shall in no event be liable for death, injuries to persons or property, or for incidental, contingent, special or consequential damages arising from the use of our product. Some states do not allow the exclusion or limitation of incidental or consequential damages, so the above limitation or exclusion may not apply to you.

THIS WARRANTY IS EXPRESSLY IN THE LIE OF ALL OTHER WARRANTIES, EXPRESS OR IMPLIED, INCLUDING THE WARRANTIES OF MERCHANTABILITY AND FITNESS.

To take advantage of this warranty, please read and follow the below rules:

- ① Our drone has a 30-day warranty for the whole unit of quality-related issues and 90-day for accessory-related issues.
- ② After receiving the item, please register your warranty information via email within 14 days to make sure the purchase is 100% covered.
- ③ If there's an issue that comes up with the product, please contact us via amazon email, support email, official website. We will either assist to repair or replace the product or refund the purchase price due to different defective problems.
- ④ If the defect resulted from causes not within the scope of our warranty, then you must bear the cost of returning the product.

Please do not hesitate to contact us if you need further support.

✉ usa@heygelo.com (US) eu@heygelo.com (EU)

This warranty gives you specific legal rights and you may also have other rights which vary from state to state.



HEYGELO
HORIZON IN YOUR CONTROL

