

HONOR MagicWatch 2

User Guide

Issue 01
Date 2019-11-26



Copyright © Huawei Technologies Co., Ltd. 2019. All rights reserved.

No part of this document may be reproduced or transmitted in any form or by any means without prior written consent of Huawei Technologies Co., Ltd.

Trademarks and Permissions



HUAWEI and other Huawei trademarks are trademarks of Huawei Technologies Co., Ltd.

All other trademarks and trade names mentioned in this document are the property of their respective holders.

Notice

The purchased products, services and features are stipulated by the contract made between Huawei and the customer. All or part of the products, services and features described in this document may not be within the purchase scope or the usage scope. Unless otherwise specified in the contract, all statements, information, and recommendations in this document are provided "AS IS" without warranties, guarantees or representations of any kind, either express or implied.

The information in this document is subject to change without notice. Every effort has been made in the preparation of this document to ensure accuracy of the contents, but all statements, information, and recommendations in this document do not constitute a warranty of any kind, express or implied.

Huawei Technologies Co., Ltd.

Address: Huawei Industrial Base
Bantian, Longgang
Shenzhen 518129
People's Republic of China

Website: <https://www.huawei.com>

Email: support@huawei.com

Contents

1 Getting started.....	1
1.1 Wearing the watch.....	1
1.2 Adjusting and Replacing the watch strap.....	2
1.3 Pairing your watch with your phone.....	6
1.4 Powering on/off and restarting the watch.....	8
1.5 Charging your watch.....	9
1.6 Buttons and gestures.....	11
1.7 Customizing the Down button.....	13
1.8 Adjusting screen brightness.....	13
1.9 Setting the vibration strength.....	14
1.10 Setting time and language.....	14
1.11 Enabling frequently used features.....	14
1.12 Unlocking your phone using your watch.....	14
1.13 Enabling Do not disturb mode.....	15
1.14 Connecting earbuds.....	15
1.15 Viewing the Bluetooth name and MAC address.....	15
1.16 Check the watch's version.....	16
1.17 Check the watch's SN.....	16
1.18 Updating the watch.....	16
1.19 Restoring the watch to its factory settings.....	16
2 App management.....	17
2.1 Getting notifications and deleting messages.....	17
2.2 Setting favorite contacts (using a watch to make/receive a call).....	18
2.3 Answering or rejecting incoming calls.....	19
2.4 Checking your call log.....	19
2.5 Playing music.....	19
2.6 Using Stopwatch or Timer.....	20
2.7 Setting an alarm.....	20
2.8 Using Flashlight.....	21
2.9 Using the Air pressure app.....	22
2.10 Using Compass.....	22
2.11 Weather reports.....	22
2.12 Finding your phone using your watch.....	23

3 Professional workouts	24
3.1 Starting a workout	24
3.2 Workout status	25
3.3 Tracking daily activities	26
3.4 Viewing the duration of moderate to high intensity activity	27
3.5 Recording workout routes	27
3.6 Syncing and sharing your fitness and health data	27
4 Fitness and health	29
4.1 Monitoring your heart rate	29
4.2 Tracking sleep	33
4.3 Testing stress levels	34
4.4 Activity reminder	35
4.5 Enabling HUAWEI TruSleep™	35
5 Watch faces	36
5.1 Changing watch faces	36
5.2 Setting Gallery watch faces	36
5.3 Installing, replacing, and deleting watch faces	39
5.4 Setting a standby watch face	40
5.5 Setting up dual time zones	40
6 FAQs	41
6.1 Factors that affect heart rate monitoring	42
6.2 The sleep data on my watch cannot be synced to the Huawei Health app	42
6.3 Detected stress level is inaccurate	43
6.4 How to get more accurate sleep data	44
6.5 Stress level is sometimes unable to display on my watch or takes a long time to display	45
6.6 The heart rate on the watch screen is displayed as "--"	45
6.7 The heart rate on the watch screen refreshes slowly, is inaccurate, or changes rapidly	45
6.8 Heart rate data on the watch is unable to be displayed or is not accurate during swimming	46
6.9 Workout route loss/inaccurate route in open water	46
6.10 The step counts on the watch and the Huawei Health app are not the same	46
6.11 My watch disconnects from my phone automatically or is unable to connect to the phone again once disconnected	46
6.12 My watch screen does not turn on when I raise my wrist	47
6.13 The weather information on my watch is unable to update	47
6.14 Display or control error when playing music on the watch	48
6.15 The positioning on my watch is slow and fails	48
6.16 My watch updates slowly	48
6.17 My watch is unable to update	49
6.18 Unable to find downloaded music in the Huawei Health app	49
6.19 Unable to receive notifications	49
6.20 How to reduce my watch's power consumption	50

1 Getting started

- 1.1 Wearing the watch
- 1.2 Adjusting and Replacing the watch strap
- 1.3 Pairing your watch with your phone
- 1.4 Powering on/off and restarting the watch
- 1.5 Charging your watch
- 1.6 Buttons and gestures
- 1.7 Customizing the Down button
- 1.8 Adjusting screen brightness
- 1.9 Setting the vibration strength
- 1.10 Setting time and language
- 1.11 Enabling frequently used features
- 1.12 Unlocking your phone using your watch
- 1.13 Enabling Do not disturb mode
- 1.14 Connecting earbuds
- 1.15 Viewing the Bluetooth name and MAC address
- 1.16 Check the watch's version
- 1.17 Check the watch's SN
- 1.18 Updating the watch
- 1.19 Restoring the watch to its factory settings

1.1 Wearing the watch

Attach the heart rate monitoring area of your watch on the top of your wrist, as shown in the following figure. To ensure the accuracy of heart rate measurement, wear your watch properly

and do not wear it above the joint in your wrist. Do not wear it too loosely or too tightly but make sure that your watch is attached securely on your wrist.

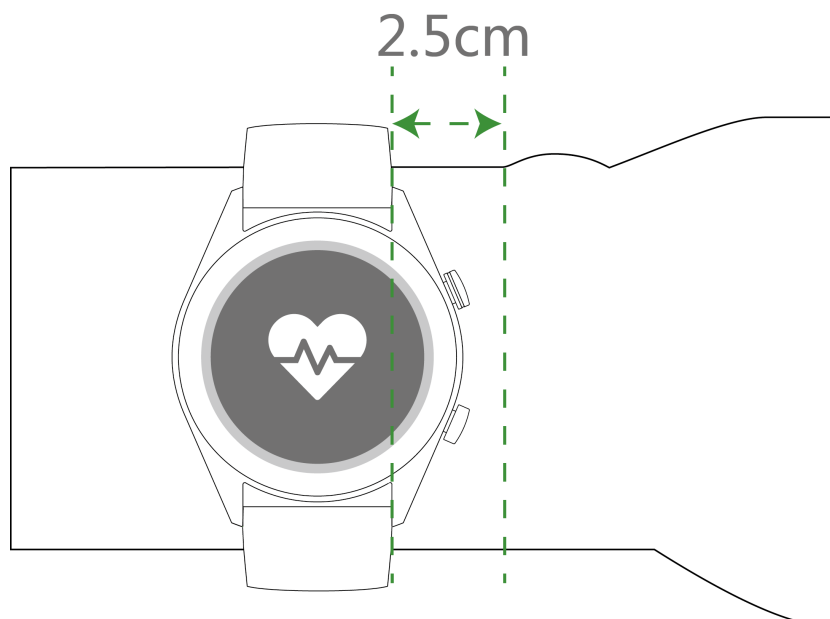

NOTE

- Your watch uses non-toxic materials that have passed strict skin allergy tests. Please rest reassured when wearing wear it. If you experience skin discomfort when wearing the watch, take it off and consult a doctor.
- Wear your watch correctly for greater comfort.
- You can wear your watch on either wrist.

1.2 Adjusting and Replacing the watch strap

Adjusting the strap

For watches with non-metallic straps and T-shaped buckles, you can adjust the strap to a comfortable fit depending on the circumference of your wrist.

If the strap is made of metallic materials, adjust it by performing the following:

Adjusting metal link straps

1. Use the screwdriver that comes with the watch to remove the screws from the links you want to remove.

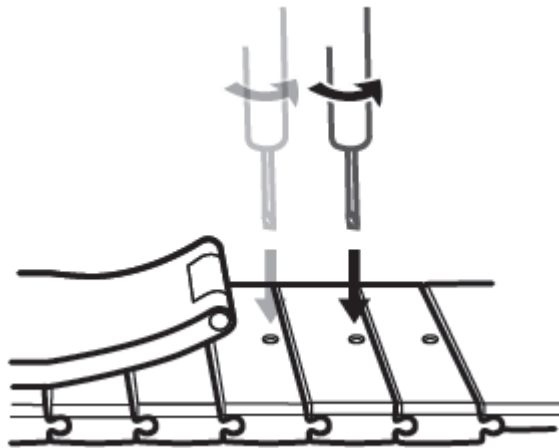

2. Remove a link from both sides of the clasp to make sure the watch face is still centered.

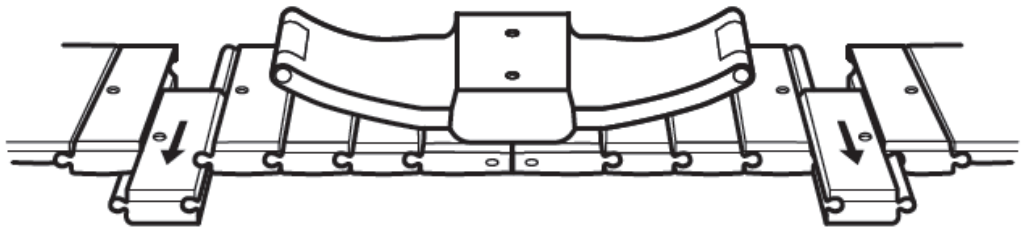

3. Re-assemble the strap.

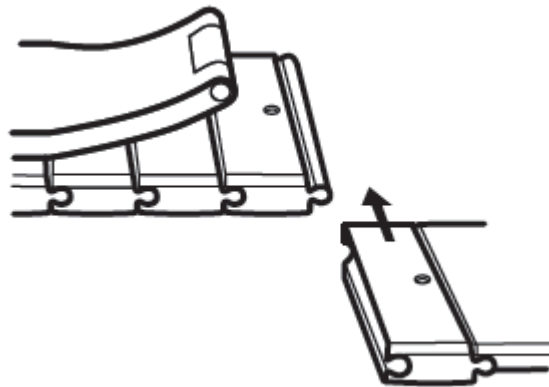

4. Put the screws back in.

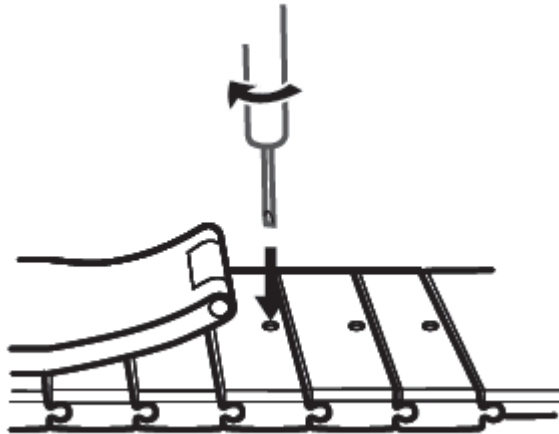

Adjusting metal mesh straps

1. Undo the clasp.



2. Pull the bottom plate upward so it is at a 90° angle with the strap.

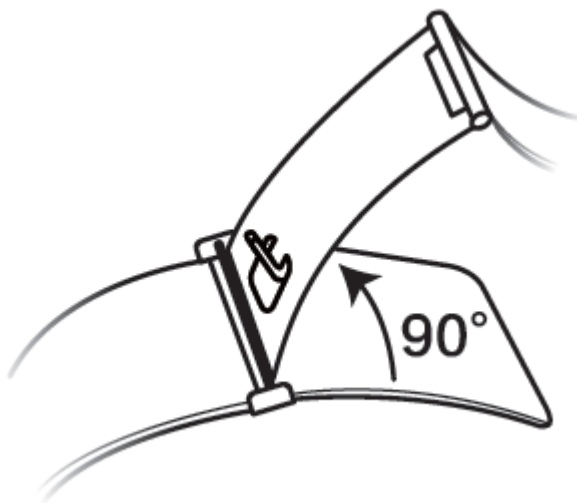

3. Slide the clasp to adjust the length.

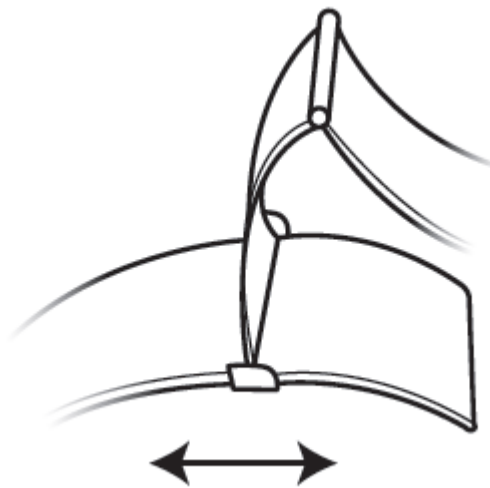

4. Align the plate with the grooves and clamp it back down. Finish by fastening the clasp.

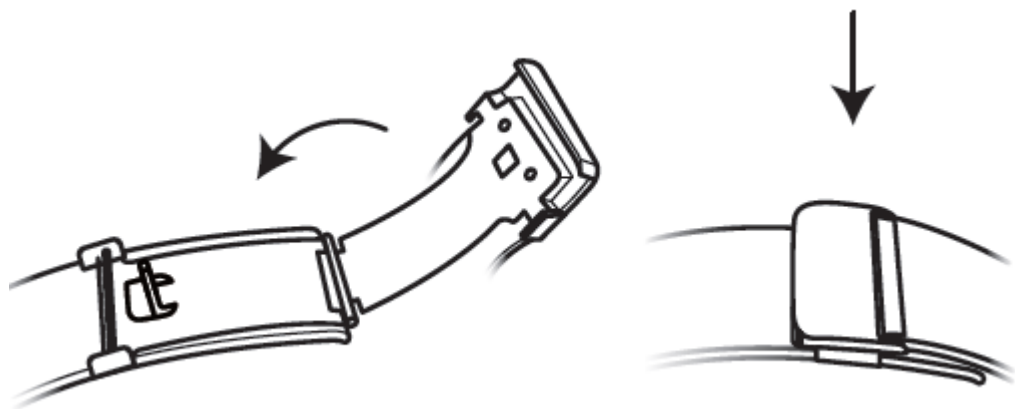

Removing and installing the strap

To remove a non-metallic strap, unlock the fastener, remove your current strap, and then release the spring pin, as shown in the following figure. Follow the steps in the reverse order to install a new strap.

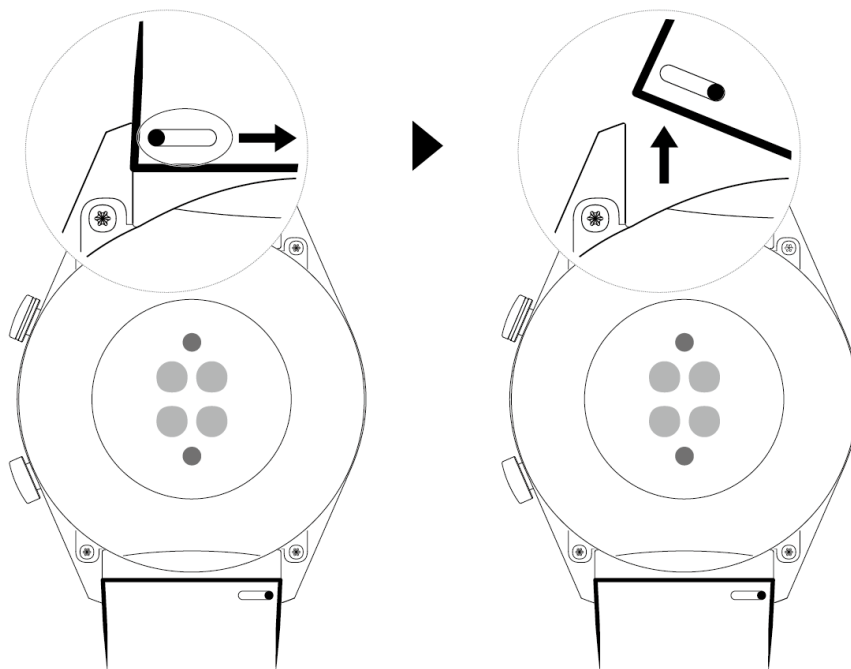

To remove a metal strap, perform the steps shown in the following figure. Follow the steps in the reverse order to install a new strap.

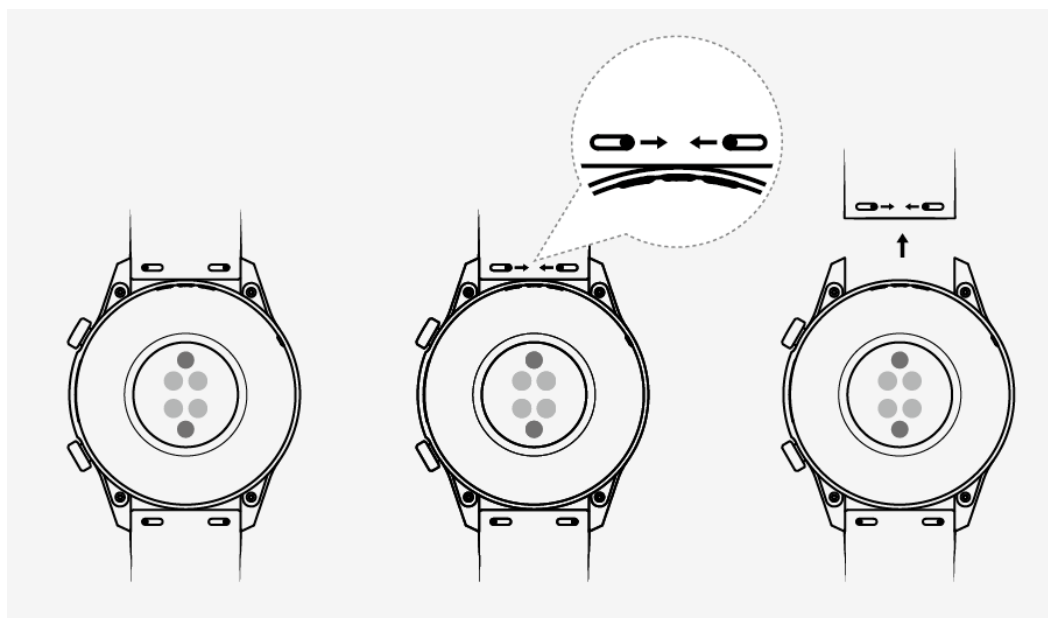

1.3 Pairing your watch with your phone

If you have just taken the watch out of the box, press the Up button and hold until your watch vibrates and displays a startup screen. The watch is ready to be paired via Bluetooth by default.

● **For Android users:**

- a. Download and install the Huawei Health app from an app store. If you have already installed it, make sure that it is up-to-date.
- b. Open the Huawei Health app and follow the onscreen instructions to grant required permissions to the app. Go to **Devices > Add > Smart Watch**, and touch the device you wish to pair.
- c. Touch **PAIR** and the app will automatically search for nearby available Bluetooth devices. Once your watch is found, touch its name to start pairing.



- d. When a pairing request is displayed on the watch screen, touch  to pair your watch and phone. Confirm the pairing on your phone as well.

● **For iOS users:**

- a. Download and install the Huawei Health app from App Store. If you have already installed it, make sure that it is up-to-date.
- b. Open the Huawei Health app, go to **Devices > + > Smart Watch**, and touch the device you wish to pair.
- c. Touch **PAIR** and the app will automatically search for nearby available Bluetooth devices. Once your watch is found, touch its name to start pairing.



- d. When a pairing request appears on your watch screen, touch  to pair your watch and phone.

HUAWEI WATCH GT2 (46 mm) follow these steps to pair:

- a. Log in to the App Store on your phone and search Huawei Health. Download and install the app, and make sure it is fully updated.
- b. On the phone go to Settings > Bluetooth. The watch should show up automatically, touch your device, then touch  to finish pairing.
- c. Open the Health app and go to the settings screen, touch + in the upper right corner and select Smart watches. Select your device's model.
- d. Touch **PAIR** and the app will automatically search for nearby available Bluetooth devices. Once your watch is found, touch its name to start pairing.



- e. When a pairing request is displayed on the watch screen, touch  to pair your watch and phone. Confirm the pairing on your phone as well.

 **NOTE**

- When pairing for the first time, you can use your phone to scan the QR code on the watch screen to download the Huawei Health app.



- If your watch does not respond after you touch  to confirm the pairing request, press the Down button and hold to unlock your watch, and initiate a pairing procedure again.
- Your watch will display an icon on the screen to inform you that pairing was successful. It will then receive information (such as the date and time) from your phone.
- If the pairing failed, your watch screen will display an icon to inform you that pairing was unsuccessful. It will then return to the startup screen.
- A watch can be connected with only one phone at any given time, and vice versa. If you want to pair your watch with another phone, disconnect your watch from the current phone using the Huawei Health app, and then pair your watch with another phone using the Huawei Health app.

1.4 Powering on/off and restarting the watch

Powering on the watch

- When the watch is powered off, press and hold the Up button to power on the watch.
- When the watch is powered off, the watch will automatically power on if you charge it.

 **NOTE**

If you power on the watch when the battery level is critically low, the watch will remind you to charge it and the watch's screen will turn off after 2 seconds. You will be unable to power on the watch until you charge it.

Powering off the watch

- When the watch is powered on, press and hold the Up button, and then touch **Power off**.
- When the watch is powered on, press the Up button while on the home screen, swipe up or down until you find **Settings**, touch it, go to **Sysem > Power off**, and then touch  to confirm.
- If the battery level is critically low, the watch will vibrate and then automatically power off.

Restarting the watch

- When the watch is powered on, press and hold the Up button, and then touch **Restart**.
- When the watch is powered on, from the home screen press the Up button, swipe until you find **Settings**, touch it, go to **Sysem > Restart**, and then touch  to confirm your choice.

Force restarting the watch

- Press and hold the Up button for at least 16 seconds to force restart the watch.

1.5 Charging your watch

Charging

1. Connect the USB Type-C port and power adapter and then plug in the power adapter.

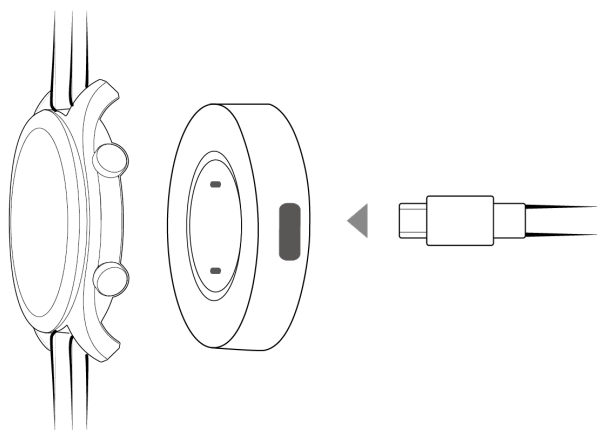

2. Rest your watch on top of the charging cradle, ensuring that the contacts on your watch and the cradle are aligned. Wait until the charging icon appears on your watch screen.
3. When your watch is fully charged, 100% will be displayed on the watch screen and the charging will stop automatically. If the battery level is below 100% and the charger is still connected to the phone, the charging will start automatically.

NOTE

- Use the dedicated charging cable, charging cradle, rated output voltage of 5 V, and rated output current of 1 A or higher to charge your watch.
- It is recommended that you lift the charging cradle to attach it to your watch. Ensure that the side of your watch with buttons is aligned with the charging port of the cradle. After the cradle and watch are connected properly, check to see if the charging icon is displayed. If you cannot see the charging icon, you may need to slightly adjust the position of the cradle until contact is established and the charging icon appears.
- Your watch will automatically power off when its battery level is too low. The  icon will be displayed during charging. After it is charged for a while, your watch will automatically power on.

Charging time

Your watch will be fully charged within two hours. When the charging indicator displays 100%, the watch is fully charged. Disconnect your watch from the power adapter once it is fully charged.

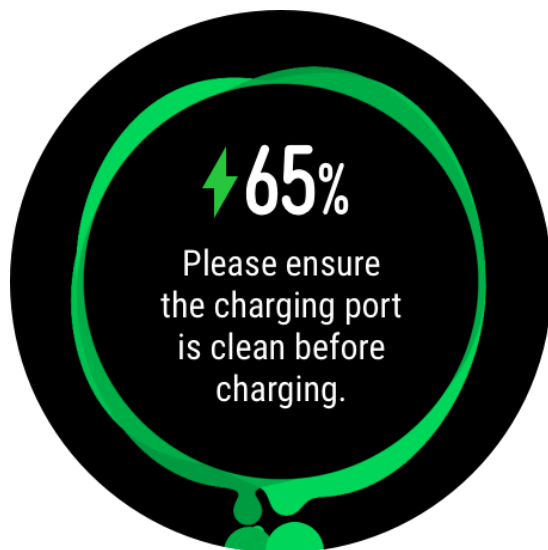

 **NOTE**

- Charge your watch in a dry and well-ventilated environment.
- Before charging, make sure that the charging port and metal parts are clean and dry to prevent short circuits or any other risks.
- Before charging, make sure the charging port is dry. Wipe off any water or sweat stains.
- The charging cradle is not water resistant, so keep it dry at all times.
- It is recommended that the ambient temperature is between 0 and 45°C.
- To protect the battery, the charging current will be reduced if the ambient temperature is low, which will prolong the charging time without affecting the battery lifespan.

Checking the Battery Level

Use one of the following three methods to check the battery level:

Method 1: When your watch is connected to the charger, you can check the battery level on the charging screen that is displayed automatically. Press the Up button to exit the charging screen.

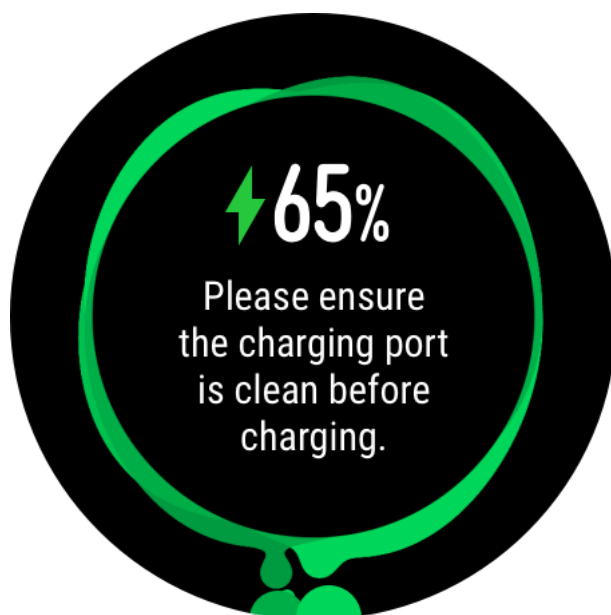

Method 2: Swipe the home screen from top to bottom and then check the battery level in the drop-down menu.

Method 3: Check the battery level on the device details screen in the Huawei Health app.



1.6 Buttons and gestures

The watch is equipped with a color touchscreen that is highly responsive to your touches and can be swiped in different directions.

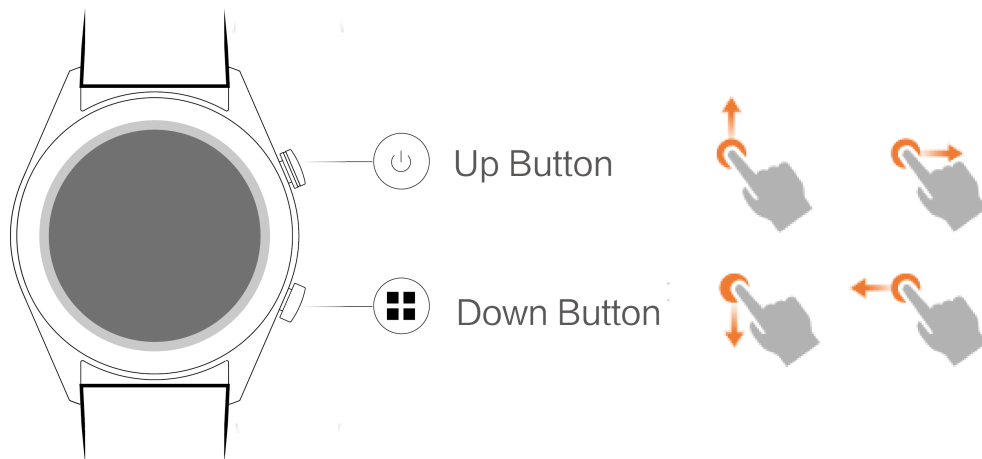

Up button

Operation	Function	Remarks
Press	<ul style="list-style-type: none"> ● Wake watch screen when the screen is off. ● Access the app list screen from the home screen. ● Return to the home screen. 	There are certain exceptional scenarios such as for calls and workouts.
Press and hold	<ul style="list-style-type: none"> ● Power on your watch when the watch is off. ● Access the restart/power off screen when the watch is on. 	

Down button

Operation	Function	Remarks
Press	Open the workout app. Access the customized feature you set.	There are certain exceptional scenarios such as for calls and workouts.

Button functions during a workout

Operation	Function
Press the Up button	Lock/unlock, mute, or end workout
Press the Down button	Switch screen.
Press and hold the Up button	Finish the workout.
Swipe up or down on the screen	Switch screen.
Touch the screen and hold	Show a different data type.

Gestures

Operation	Function
Touch	Choose and confirm.
Touch and hold on the home screen	Change the watch face.

Operation	Function
Swipe up on the home screen	View notifications.
Swipe down on the home screen	View the shortcut menu.
Swipe left or right	View your heart rate data, workout data, weather information, and Alipay information.
Swipe right	Return to the previous screen.

Wake the screen

- Press the Up button.
- Raise or rotate your wrist inwards.
- Swipe down on the home screen to open the shortcut menu. Enable **Show Time** and the screen will stay on 5 minutes.

NOTE

You can enable the **Raise wrist to wake screen** function in the Huawei Health app by going to the details screen of your watch.

Turn off the screen

- Lower or rotate your wrist outwards.
- The screen will turn off automatically 5 seconds after the watch's screen is turned on if no operation is performed within this period of time. If any operation is performed, the screen will turn off 15 seconds after it is turned on.

NOTE

From the home screen press the Up button and go to **Settings > Display > Advanced** to adjust the duration it takes for your watch to go to sleep and turn off the screen. The duration is set to **Auto** by default.

1.7 Customizing the Down button

1. From the home screen press the Up button and go to **Settings > Down button**.
2. Touch an app from the list. This app will be opened when you press the Down button.

NOTE

By default, pressing the Down button will open the Workout app.

1.8 Adjusting screen brightness

From the home screen press the Up button and go to **Settings > Display > Brightness** to adjust the screen brightness. Brightness is set to **Auto** by default, which automatically adjusts

screen brightness based on your environment. Level 5 is the brightest setting and Level 1 is the dimmest setting.

1.9 Setting the vibration strength

1. From the home screen press the Up button, then go to **Settings** > **Strength**.
2. Swipe up or down on the screen and select **Strong**, **Soft**, or **None**. Touch **OK**. Your watch will then automatically return to the previous screen and vibrate with the strength that you set.

1.10 Setting time and language

You do not need to set the time and language on your watch. When the watch is connected with your phone, the time and language settings on your phone will be automatically synced to your watch.

If you change the language, time, or time format on your phone, the changes will be automatically synced to your watch when the watch and phone are connected.

NOTE

- For iOS users: Open your phone, go to **Settings** > **General** > **Language & Region**, set the language and region, and then connect the watch with your phone to sync the settings.
- For Android users: Taking EMUI 9.0 as an example, open your phone, choose **Settings** > **System** > **Language & input**, set the language, and then connect the watch with your phone to sync the settings.

1.11 Enabling frequently used features

After connecting your watch to your phone through the Huawei Health app, you can enable features for your watch in the app. Frequently used features include:

- HUAWEI TruSleep™
- Activity reminder
- Continuous heart rate monitoring
- Automatic stress test
- Notifications
- Weather reports
- Bluetooth disconnection reminder
- Raise wrist to wake screen

1.12 Unlocking your phone using your watch

Whether this feature is supported depends on your phone's specifications.

To enable this feature, perform the following: (The following example is with a phone running EMUI 9.0.)

1. Ensure that your phone and watch have been paired.

2. On your phone, go to **Settings > Security & privacy > Lock screen password > Smart unlock**. Set your lock screen password and add your watch as a trusted device.
3. You can now access your phone just by swiping on the phone screen and without having to enter a password.

 **NOTE**

This feature will only work when your phone and watch are connected.

1.13 Enabling Do not disturb mode

To enable Do not disturb mode, swipe down on your watch's home screen, touch **No Disturb**, and then touch ✓ to confirm.

If your watch enters Do not disturb mode:

1. The watch will not vibrate for incoming calls, but you can still answer or reject incoming calls with the watch.
2. Messages and notifications will not be displayed on the watch, and the Raise wrist to wake screen feature will be disabled.

 **NOTE**

If your watch does not support the calling feature, you will be unable to answer or reject incoming calls with the watch.

1.14 Connecting earbuds

1. From the home screen press the Up button and go to **Settings > Earbuds**.
2. Your watch will search automatically for the Bluetooth earbuds list for pairing. Select the name of your earbuds and follow the onscreen instructions to complete the pairing.

 **NOTE**

- If Bluetooth earbuds are connected via the watch and you answer a call from the watch, the audio will play from the watch's speaker. Audio for calls cannot go through the earbuds yet.
- If you would like to use your Bluetooth earbuds for calls, connect the earbuds to your phone and answer calls from your phone too.

1.15 Viewing the Bluetooth name and MAC address

To view the Bluetooth name and MAC address of your watch, use any of the following methods:

Method 1: On the home screen of your watch, press the Up button and go to **Settings > About**. The **Device name** is your watch's Bluetooth name. The 12 alphanumeric characters under **MAC** are your watch's MAC address.

Method 2: Your watch's MAC address is laser engraved on the back of the watch. The 12 alphanumeric characters next to "MAC:" are your watch's MAC address.

Method 3: Connect the watch to the phone and view the MAC address in the Huawei Health app.

Open the Huawei Health app, touch **Devices** and then your device name. Locate **Restore factory settings**, and the 12 alphanumeric characters next to it are your watch's MAC address.

1.16 Check the watch's version

From the home screen press the Up button, swipe until you find **Settings**, touch it, then touch **About**, and your watch's version information will be displayed.

1.17 Check the watch's SN

From the home screen press the Up button, swipe until you find **Settings**, touch it, then touch **About**, and your watch's SN (serial number) will be displayed under **SN**.

1.18 Updating the watch

Method 1:

Connect the watch to your phone using the Huawei Health app, open the app, touch **Devices**, touch the device name, choose **Firmware update**, then follow the onscreen instructions to update your watch if there are any new updates.

Method 2:

- For Android users: Open the Huawei Health app, touch **Devices**, touch the device name, then enable **Auto-download update packages over Wi-Fi**. If there are any new updates, the watch will display update reminders. Follow the onscreen instructions to update your watch.
- For iOS users: Open the Huawei Health app, touch the profile picture in the upper-left corner on the home screen, touch **Settings**, then enable **Auto-download update packages over Wi-Fi**. If there are any new updates, the watch will display update reminders. Follow the onscreen instructions to update your watch.

NOTE

During an update, the watch will automatically disconnect from your phone.

1.19 Restoring the watch to its factory settings

Method 1: From the home screen press the Up button, swipe until you find **Settings**, touch it, go to **System > Reset**, and then touch  to confirm. As all the data on your watch will be removed when you restore the watch to its factory settings, please exercise caution before confirming.

Method 2: Open the Huawei Health app, touch **Devices**, touch the device name, and then touch **Restore factory settings**.

2 App management

- [2.1 Getting notifications and deleting messages](#)
- [2.2 Setting favorite contacts \(using a watch to make/receive a call\)](#)
- [2.3 Answering or rejecting incoming calls](#)
- [2.4 Checking your call log](#)
- [2.5 Playing music](#)
- [2.6 Using Stopwatch or Timer](#)
- [2.7 Setting an alarm](#)
- [2.8 Using Flashlight](#)
- [2.9 Using the Air pressure app](#)
- [2.10 Using Compass](#)
- [2.11 Weather reports](#)
- [2.12 Finding your phone using your watch](#)

2.1 Getting notifications and deleting messages

Getting notifications

Ensure that the watch is paired with your phone using the Huawei Health app, then perform the following:

For Android users: Open the Huawei Health app, touch **Devices**, and then touch your device. Touch **Notifications** and enable **Notifications**. Turn on the switch for apps for which you want to receive notifications.

For iOS users: Open the Huawei Health app, touch **Devices**, and then touch your device. Touch **Notifications** and enable **Notifications**. Turn on the switch for apps for which you want to receive notifications.

Your watch will vibrate to notify you when a new message is displayed on your phone's status bar.

Swipe up or down on the watch screen to view message content. A maximum of 10 unread messages can be stored on your watch. If there are more than 10 unread messages, only the latest 10 messages will be displayed. Each message can be displayed on one screen.

NOTE

- Your band can display messages from the following apps: SMS, Email, Calendar, and various social media platforms.
- You are not able to reply directly on your watch when you receive an SMS message, WeChat message, or email.
- Your watch will still receive notifications but will not alert you if your watch is in Do not disturb, Sleep mode, or it detects you aren't wearing it.
- If you receive a new message when you are reading another message, your watch will display the new message.
- When your watch is in Do not disturb or Sleep mode or during a workout, it will still receive notifications but will not alert you. You can swipe up on your watch home screen to view new messages.
- If you phone and watch are connected, your phone will push an alert to your watch over Bluetooth when you receive an incoming call or message on your phone. Due to the slight delay in sending information over Bluetooth, your phone and watch will not receive the alert at exactly the same time.
- Reminders and incoming call notifications on your watch won't be affected if other Bluetooth devices are also connected to your phone.
- You are able to receive voice messages and images from third-party social media apps but you are unable to listen to voice messages or view images.

Deleting messages

To delete a message, swipe right on it. To delete all messages, touch **Clear**.

2.2 Setting favorite contacts (using a watch to make/receive a call)

1. Open the Huawei Health app and touch **Devices**. Touch your device name to access the watch settings screen. Touch **Favorite contacts**.
2. Then perform the following:
 - Touch **ADD** and your phone contacts list will appear. Then select the contacts you wish to add.
 - Touch **Sequence** to sort the contacts you have added.
 - Touch **Remove** to remove a contact you have added.
3. From the home screen press the Up button, swipe until you find **Contacts** to call your favorite contacts from your watch.

NOTE

1. A maximum of 10 favorite contacts can be added to your watch.
2. Make sure your watch and phone are connected before making a call from you watch.
3. To adjust the volume during the call, touch the speaker icon on the screen or press the Up button or Down button.
4. A maximum of 30 call records can be saved.

2.3 Answering or rejecting incoming calls

When your watch is connected to your phone and you receive a call, your watch will vibrate and display the caller's number and name. You can choose to answer or reject the call.

NOTE

- The incoming call information displayed on your watch matches the information displayed on your phone. If the caller is unknown, the phone number will be displayed. If you have the number saved in your contacts, the caller's name will be displayed.
- Your watch will not vibrate and turn on its screen upon incoming calls when **Do not disturb** is enabled or when you are not wearing your watch.
- You can stop the watch from vibrating by pressing the Up button.
- You can reject an incoming call by touching the reject icon on the watch screen.
- You are able to adjust the volume during calls.

2.4 Checking your call log

1. From the home screen press the Up button, swipe until you find **Call Log**, touch it to view call logs.
2. Touch an entry to call them back.
3. Swipe down to the bottom of the screen and touch **Clear** to clear all call logs.

2.5 Playing music

NOTE

The music feature is only available with Android.

1. Open the Huawei Health app, touch **Devices**, touch the device name, and then touch **Music**.
2. Touch **Manage music** > **Add songs**, select the music as needed from the list, and touch \checkmark in the upper-right corner of the screen.
3. From the home screen press the Up button, swipe until you find **Music**, and then touch it.
4. Choose music that you have added in the Huawei Health app and then touch the play icon to play the music.



NOTE

- Music can be played through third-party social media apps, only MP3 and AAC (LC-AAC) files can be added to the watch locally.
- You can also create a playlist by performing the following: Touch **New playlist** in the Huawei Health app and then add the music that has been synced to your watch to the playlist.
- On the music playback screen of your watch, you can switch between songs, adjust the volume, and select a playback mode, such as Play in order, Shuffle, Repeat the current song, and Repeat list. Swipe up to view the music list, touch the Settings icon in the lower-right corner of the screen to delete music, connect the watch to Bluetooth earphones, control the music playback on your watch, or control music playback on your phone. Using your watch to control the music playback on your phone is available only on Android phones.
- To use your watch to control music playing on your phone, open the Huawei Health app, touch **Devices** and touch your device's name, touch **Music** and enable **Control phone music**.
- You can use your watch to control music playback in third-party music apps on your phone.

2.6 Using Stopwatch or Timer

Stopwatch

From the home screen press the Up button, swipe until you find **Stopwatch**, and then touch it.

Touch  to start timing. Touch  to reset the stopwatch. Swipe right on your watch screen to exit Stopwatch.

Timer

From the home screen press the Up button, swipe until you find **Timer**, and then touch it. By default, there are 8 available countdown modes: 1 minute, 3 minutes, 5 minutes, 10 minutes, 15 minutes, 30 minutes, 1 hour, and 2 hours. Choose a countdown mode depending on the situation.

Touch  to start the countdown, touch  to pause the countdown, and touch  to stop the countdown.

You can also customize the timer. On the Timer screen, touch **Custom**, set the time, and touch  to start the countdown.

Swipe right on your watch screen to exit Timer.

2.7 Setting an alarm

You can use the Huawei Health app to set a Smart alarm or an Event alarm for your watch. The Smart alarm will wake you up if it detects that you are in a light sleep during a preset period. This helps to gradually wake up your brain and make you feel more refreshed.

Method 1: Setting an alarm using your watch

1. From the home screen press the Up button, swipe until you find **Alarm**, touch it, and then touch + to add an alarm.
2. Set the alarm time and repeat cycle and touch **OK**.

3. Touch an alarm to edit or delete it.

 **NOTE**

- If you do not set the repeat cycle, the alarm is a one-time alarm by default.
- Your device will currently only vibrate but not ring to inform you.

Method 2: Setting a Smart/Event alarm using the Huawei Health app



For Android users:

1. Open the Huawei Health app, touch **Devices**, touch your device name, and then go to **Alarm > SMART ALARM**, or go to **Alarm > EVENT ALARMS**.
2. Set the alarm time, tag, and repeat cycle.
3. Touch  in the upper-right corner to save the settings.
4. Swipe down on the home screen to ensure that the alarm settings are synced to your watch.
5. Touch an alarm to edit or delete it.

For iOS users:

1. Open the Huawei Health app, touch **Devices**, and then touch your device name from the device list.
2. Go to **Alarm > Event Alarms** or go to **Alarm > Smart Alarm**.
3. Set the alarm time, tag, and repeat cycle.
4. Touch **Save**.
5. Swipe down on the home screen to ensure that the alarm settings are synced to your watch.
6. Touch an alarm to edit or delete it.

 **NOTE**

- Event alarms set on your watch can be synced to the Huawei Health app. You can set a maximum of five Event alarms.
- You can only set one Smart alarm for your watch.
- The Event alarm will ring at the specified time. If you set a tag for the Event alarm, the watch will display the tag. Otherwise, only the time will be displayed.
- When an alarm rings, touch  on your watch screen, press the up button, or swipe right on your watch screen to snooze for 10 minutes. To turn off the alarm, touch  on your watch screen or press and hold the Up button.
- When an alarm rings, the alarm will automatically turn off after snoozing three times if no other operations are performed.
- Currently, only alarms set on on Huawei or Honor phones running EMUI 8.1 or later or Magic UI 2.0 or later can be synced to the watch.

2.8 Using Flashlight

From the home screen press the Up button, swipe until you find **Flashlight**, and then touch it to turn on the flashlight. Touch the screen to turn off the flashlight and touch the screen again to turn it on. Swipe right on your watch screen to exit Flashlight.

2.9 Using the Air pressure app

You can check the altitude and atmospheric pressure of your current location on your watch.

From the home screen press the Up button, swipe until you find **Air pressure**, and touch it to check the altitude and air pressure of your current location and a graph showing atmospheric changes of the current day.

Altitude:

Altitude measurement range: - 800 to 8800 meters.

Air pressure:

Air pressure measurement range: 300 to 1100 hPa.

Swipe up or down to check altitude and air pressure respectively.

2.10 Using Compass

From the home screen press the Up button, swipe until you find **Compass**, touch it, and then follow the onscreen instructions to calibrate it. After it is successfully calibrated, your watch will display a compass dial.

2.11 Weather reports

You can check your watch to find out about the weather in your local area.

Method 1: Viewing the weather information on a watch face that can display weather data

Ensure that you are using a watch face that displays weather information, then you can check the latest weather information on the home screen.

Method 2: Viewing the weather information on the weather screen

Swipe right on the screen until you find the weather screen, then you can check your location, the latest weather, temperature

Method 3: Viewing the weather information in the Weather app

From your home screen press the Up button, swipe until you find **Weather**, touch it, and then you can check your location, the latest weather information, temperature, and air quality.

NOTE

- To check the weather information on your watch, you are advised to open the Huawei Health app, touch **Devices**, touch your device name, and then enable **Weather reports**.
- The weather information displayed on your watch may differ slightly from that displayed on your phone, since the information is collected from different weather service providers.
- Ensure that you have granted your phone and the Huawei Health app the permission to access your location. For versions earlier than EMUI 9.0, select **Use GPS, WLAN, and mobile networks** as the positioning mode instead of **Use GPS only**.

2.12 Finding your phone using your watch

From the home screen press the Up button, swipe until you find **Find my phone**, or swipe down on the home screen and touch **Find Phone**. An animation will be displayed on the screen. If your phone is within Bluetooth range, it will play a ringtone to alert you, even in Silent mode.

Touch your watch screen or unlock your phone screen to stop playing the ringtone.

NOTE

This feature will only work when your phone and watch are connected.

3 Professional workouts

- [3.1 Starting a workout](#)
- [3.2 Workout status](#)
- [3.3 Tracking daily activities](#)
- [3.4 Viewing the duration of moderate to high intensity activity](#)
- [3.5 Recording workout routes](#)
- [3.6 Syncing and sharing your fitness and health data](#)

3.1 Starting a workout

Your watch supports multiple workout modes. Choose a workout mode and start exercising.

Running Courses

The watch has been preinstalled with a series of running courses, from entry-level to advanced, that provide personalized and real-time guidance. You can choose different courses on your watch.

1. From the home screen press the Up button, swipe until you find **Workout**, touch it, choose **Running Courses**, choose a course that you want to use, and then start running as prompted by your watch.
2. During a workout, press the Up button to pause or end the running course, or press the Down button to switch between screens and view different workout data.
3. After a workout, touch **Workout records** to view detailed workout records, including training effects, overall performance, speed, steps, total height, heart rate, heart rate zone, cadence, pace, and VO₂max.

NOTE

To view detailed workout data, you can also open the Huawei Health app and touch **Exercise records**.

Starting a workout

Starting a workout using your watch:

1. From the home screen press the Up button, swipe until you find **Workout**, and then touch it.
2. Swipe up or down until you find your workout type. Before a workout, you can touch the Settings icon located next to each workout mode to configure target, reminders, and display settings.

 **NOTE**

There is no Settings icon located next to Triathlon mode. In Triathlon mode, press the Down button to move to the next form.

3. Touch the Start icon to start a workout. During a workout, touch and hold the workout data screen until the watch vibrates, touch any workout data (such as heart rate, speed, distance, and time), and then choose what to display on the screen in real time.
4. During a workout, press the Up button to pause or end the workout, or press the Down button to switch between screens and view different workout data. (Take Outdoor Run mode as an example. During the workout, you can view a range of data displayed next to Heart rate, Pace, Distance, Time, Steps, Cadence, Total calories, and Total climbing. Different workout modes display different types of data.)
5. After a workout, touch **Workout records** to view detailed workout records.

Starting a workout using the Huawei Health app:

To start a workout using the Huawei Health app, you need to bring your phone and watch together to ensure that they are connected properly.

1. Open the Huawei Health app, touch **Exercise**, choose a workout mode, and then touch the Start icon to start a workout.
2. Once you have started a workout, your watch will sync and display your workout heart rate, step count, speed, and time.
3. During a workout, the Huawei Health app displays workout time and other data.

 **NOTE**

- If the workout distance or time is too short, the results will not be recorded.
- To avoid draining your battery, make sure you hold the stop icon after a workout to end it.

3.2 Workout status

The Workout status app on your watch can demonstrate your fitness status variation and your training load from the last seven days. You can review and modify your current workout plan with the help of this app. The app can also demonstrate your recovery time, high efficiency levels, peak status, training interruptions, and low efficiency levels. On the Training load screen, you can view your training load from the last seven days. Training load is classified as High, Low, or Optimal, and you can determine your level based on your fitness status.

The Workout status app mainly tracks your training load and VO₂max variations.

The watch collects your training load from workout modes which track your heart rate, such as running, walking, cycling, and climbing, and collects your VO₂max value when you start an outdoor running workout. The watch cannot display your workout status if it has not collected any VO₂max values. VO₂max variation will be displayed only if you use Outdoor Run mode at least once a week (at least 2.4 kilometers within 20 minutes for each workout), and the watch collects at least two VO₂max values with an interval of more than a week.

From the home screen press the Up button, swipe until you find **Workout status**, touch it, and then swipe up on the screen to view your workout status.

NOTE

Fitness status (VO₂max) variation is an important indicator of your workout status. Your watch will display your VO₂max variation and your workout status only if you use Outdoor Run mode at least once a week, and the watch collects at least two VO₂max values with an interval of more than a week.

3.3 Tracking daily activities

As your watch comes equipped with a motion sensor, it can track and display your steps, amount of calories burned, activity intensity, and standing times.

Wear your watch correctly for it to automatically record data relating to calories, distance, steps, duration of moderate to high intensity activities, and other activities.

You can view activity records by performing the following:

Method 1: Viewing activity records on your watch

From the home screen press the Up button, swipe until you find **Activity records**, touch it, and then you can swipe up or down to view data relating to calories, distance, steps, duration of moderate to high intensity activities, and other activities.



Method 2: Viewing activity records using the Huawei Health app

Open the Huawei Health app and view activity records on the home screen.

 **NOTE**

- To view your activity records using the Huawei Health app, ensure that the watch is connected to your phone.
- Workout data on your watch can be synced to the Huawei Health app, but data recorded in the app cannot be synced to your watch.

3.4 Viewing the duration of moderate to high intensity activity

Viewing the duration of moderate to high intensity activity

From the home screen press the Up button, swipe until you find **Activity records**, touch it,

and then the duration of moderate to high intensity activity is displayed next to .

(Taking  **25/30 分钟** as an example, it indicates that you have done 25 minutes of moderate to high intensity activity during that day. The recommended duration is 30 minutes per day.)

 **NOTE**

Android users can also check the duration of moderate to high intensity activity on the home screen of the Huawei Health app. The data displayed in the Huawei Health app is collected from both your phone and watch. Therefore, there is nothing to be concerned about if there is a data discrepancy between the app and your watch.

3.5 Recording workout routes

The watch features built-in GPS. Even if disconnected from your phone, the watch can still record your workout routes when you start Outdoor Run, Outdoor Walk, Outdoor Cycle, Climb, and other outdoor modes.

 **NOTE**

Different models support different outdoor workout modes.

If you cannot view workout routes on your watch, sync the workout data to the Huawei Health app and view the workout routes and other detailed workout data under **Exercise records** in Huawei Health.

3.6 Syncing and sharing your fitness and health data

You can share your fitness data to third-party apps and compare with your friends.

For Android users:

To share your fitness data to a third-party app, open the Huawei Health app, go to **Me > Settings > Data sharing** and select the platform you want to share to. Follow the onscreen instructions specific to each platform.

For iOS users:

To share your fitness data to a third-party app, open the Huawei Health app, go to **Discover** > **Third party services** and select the platform you want to share to. Follow the onscreen instructions specific to each platform.

4 Fitness and health

[4.1 Monitoring your heart rate](#)

[4.2 Tracking sleep](#)

[4.3 Testing stress levels](#)

[4.4 Activity reminder](#)

[4.5 Enabling HUAWEI TruSleep™](#)

4.1 Monitoring your heart rate

The HUAWEI WATCH GT 2 features an optical heart rate sensor, which can monitor and record your heart rate all day. To use this feature, you need to enable **Continuous heart rate** in the Huawei Health app.

NOTE

When the watch detects that the user has fallen sleep, it will switch to use the non-visible light to measure your heart rate, letting you have a good nights sleep.

Heart rate measurement

1. Keep your arm still and wear your watch correctly.
2. From the home screen press the Up button, swipe until you find **Heart rate**. Touch **Heart rate**. The watch will then measure your current heart rate.
3. To pause the heart rate measurement, swipe right on your watch screen.

It usually takes approximately 6 to 10 seconds to display the first measurement value (1 to 2 seconds if **Continuous heart rate monitoring** is enabled in the Huawei Health app and **MONITORING MODE** is set to **Real-time**), and the data updates every 5 seconds afterward. A complete measurement takes approximately 45 seconds to complete.

 **NOTE**

To guarantee a more accurate heart rate measurement, wear the watch correctly and ensure the strap is fastened. Make sure that your watch is secure on your wrist. Ensure that the watch body is in direct contact with your skin without any obstructions.

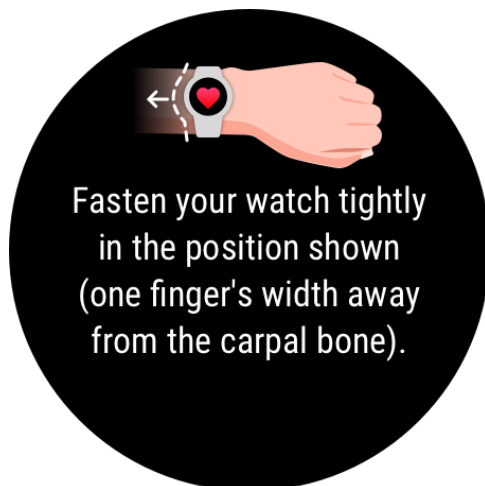

Heart rate measurement during an individual workout

During a workout, your watch can display your real-time heart rate and heart rate zone, and notify you when your heart rate exceeds the upper limit. For the best training result, you are advised to choose a workout based on your heart rate zone.

- Setting the heart rate zone calculation method

The heart rate interval can be calculated based on the maximum heart rate percentage or HRR percentage. To set the heart rate interval calculation method, open the Huawei Health app, go to **Me > Settings > Heart rate limit and zones** and set **Calculation method** to either **Maximum heart rate percentage** or **HRR percentage**.

 **NOTE**

- If you select **Maximum heart rate percentage** as the calculation method, the heart rate zone for different types of workout activities (Extreme, Anaerobic, Aerobic, Fat-burning, and Warm-up) is calculated based on your maximum heart rate ("220 - your age" by default).
Heart rate = Maximum heart rate x Maximum heart rate percentage.
- If you select HRR percentage as the calculation method, the heart rate interval for different types of workout activities (Advanced anaerobic, Basic anaerobic, Lactic acid, Advanced aerobic, and Basic aerobic) is calculated based on your heart rate reserve (HRmax - HRrest).
Heart rate = Heart rate reserve x Heart rate reserve percentage + Resting heart rate.
- The heart rate zone calculation methods while you are running are not affected by the settings in the Huawei Health app. For most running courses, **HRR percentage** is selected by default.

Your watch will display different colors when your heart rate reaches corresponding zones during a workout. The following figure shows how heart rate is displayed during an outdoor run.



- Measuring your heart rate during a workout
 - a. After you start a workout, swipe on the watch screen to check your real-time heart rate and heart rate zone.
 - b. After completing your workout, you can check your average heart rate, maximum heart rate, and heart rate zone on the workout results screen.
 - c. You can view graphs that show the changes in heart rate, maximum heart rate, and average heart rate for each workout under **Exercise records** in the Huawei Health app.

 **NOTE**

- Your heart rate will not be displayed if you remove the watch from your wrist during the workout. However, the watch will continue to search for your heart rate for a while. The measurement will resume once you wear the watch again.
- Your watch can measure your heart rate when you have connected it to your phone and started a workout using the Huawei Health app.
- Heart rate monitoring during swimming is supported on the HUAWEI WATCH GT 2.

Continuous heart rate monitoring

To enable this feature, connect your watch to your phone using the Huawei Health app and enable **Continuous heart rate monitoring** in the Huawei Health app. Once this feature is enabled, your watch can measure your real-time heart rate.

Set the **MONITORING MODE** to **Smart** or **Real-time**.

- Smart mode
 - a. The heart rate measurement will be performed every 10 minutes for low-intensity activities (such as when you are not moving).
 - b. The heart rate measurement will be performed every 10 minutes for moderate-intensity activities (such as when you are walking).
 - c. The heart rate measurement will be performed once a second for high-intensity activities (such as when you are running) and it takes 6 to 10 seconds to display the first heart rate value, though this may vary between individuals).
- Real-time mode: The heart rate measurement will be performed once a second for any type of activity intensity.

When this feature is enabled, the watch will continuously measure your real-time heart rate. You can view graphs for your heart rate in the Huawei Health app.

NOTE

Using Real-time mode will increase the power consumption of your watch while Smart mode will adjust the heart rate measurement interval based on the intensity of your activity, thus reducing power consumption.

Resting heart rate measurement

Resting heart rate refers to the heart rate when it is measured in a quiet and relaxed environment when you are awake. It is a general indicator of cardiovascular health.

The best time to measure your resting heart rate is immediately after you have woken up in the morning. Your actual resting heart rate may not be displayed or accurately measured if your heart rate was measured at the wrong time.

To automatically measure your heart rate, enable **Continuous heart rate monitoring** in the Huawei Health app.

If "--" is displayed as the resting heart rate reading, it indicates that your watch was unable to measure your resting heart rate. In this case, ensure that you measure your resting heart rate in a quiet and relaxed environment when you are awake. It is recommended that you measure your resting heart rate immediately after you wake up in the morning for the most accurate result.

NOTE

If you disable **Continuous heart rate monitoring** after checking your resting heart rate, the resting heart rate displayed in the Huawei Health app will remain the same.

Heart rate warning

After you start a workout using your watch, your watch will vibrate to alert you that your heart rate value has exceeded the upper limit for more than 10 seconds. To view and configure your heart rate limit, perform the following:

Open the Huawei Health app, go to **Me > Settings > Heart rate limit and zones** and select your desired heart rate limit. The following figure shows how to set your heart rate limit:

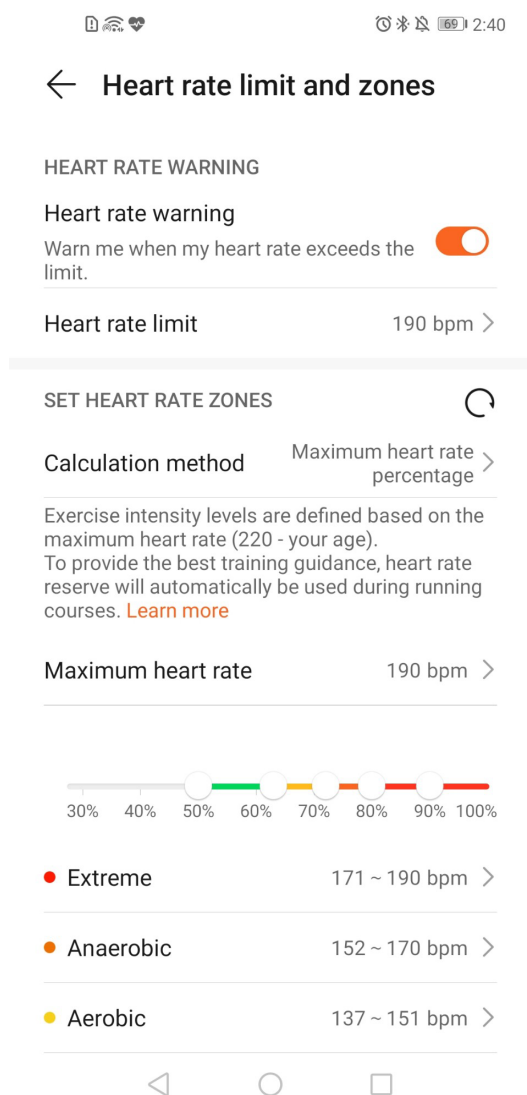

NOTE

- The default heart rate limit is 200 - age, which is obtained from the personal information you enter.
- If you disable voice guidance for individual workouts, you will only be alerted through vibrations and card prompts.
- Heart rate alerts are only available during active workouts and are not generated during daily monitoring.

To enable **High heart rate alerts** for your resting heart rate, open the Huawei Health app, touch **Devices** then your device, go to **Continuous heart rate monitoring > High heart rate alert**, and set your heart rate upper limit. Then, touch **OK**. When you are not doing any exercise, you will receive an alert when your resting heart rate stays above your set limit for more than 10 minutes.

4.2 Tracking sleep

Your watch collects sleep data and identifies your sleep status when you wear it while sleeping. It can automatically detect when you fall asleep and wake up and whether you are in

a light or deep sleep. You can sync and view your sleep data in detail in the Huawei Health app.

Your watch measures your sleep data from 20:00 to 20:00 on the following day (24 hours in total). For example, if you sleep for 11 hours from 19:00 to 06:00, your watch will count the length of time you slept before 20:00 during the first day as well as the rest of the time that you were asleep during the second day.

From the home screen press the Up button, swipe until you find **Sleep**, then touch it and swipe up on the screen to view your nighttime sleep duration and nap duration. Your daytime sleep duration is displayed under **Naps**.

You are able to view your history sleep data in the Huawei Health app. Open the Huawei Health app and touch Sleep to view your daily, weekly, monthly, and yearly sleep statistics.

NOTE

Naps that you take during the day are counted under **Naps**. If you take a midday nap of less than 30 minutes or you moved around too much during a midday nap, your watch may have determined incorrectly that you were awake.

You can enable **HUAWEI TruSleep™** in the Huawei Health app.

After you enable **HUAWEI TruSleep™**, your watch will collect your sleep data, detect when you fall asleep, wake up, and whether you are in a light, deep, or REM sleep, and identify the times when you wake up and your breathing quality to provide you with a sleep quality analysis and suggestions to help you understand and improve your sleep quality.

When your watch detects that you are sleeping, it will automatically disable Always-on screen, message reminders, incoming call notifications, Raise wrist to wake screen, and other features in order to not disturb your sleep.

4.3 Testing stress levels

You can use your watch to test your stress level on a one-off or periodic basis.

- To measure your stress level on a one-off basis: Open the Huawei Health app, touch **Stress** then **Stress test**. When using this feature for the first time, you need to calibrate the stress value. Follow the onscreen instructions in the Huawei Health app to answer the questionnaire for a better stress test result.
- To measure your stress level on a periodic basis: Open the Huawei Health app, touch **Devices**, then touch your device name, enable **Automatic stress test** and follow the onscreen instructions to calibrate the stress value. Make sure that you are wearing your watch correctly and the watch will periodically test your stress level.

Viewing stress data:

- Viewing stress data on the watch: Press the Up button while on the home screen, swipe up or down until you find **Stress**, and touch it to view the graph indicating your stress change, including the stress bar chart, your stress level, and your stress interval.
- Viewing stress data in the Huawei Health app: Open the Huawei Health app, touch **Stress** to view your latest stress level and your daily, weekly, monthly and yearly stress curve and corresponding advice. At the same time, you can refer to content under **STRESS RELIEF ASSISTANT** to reduce your stress and stay relaxed.

NOTE

- Stress tests are only available with a HUAWEI WATCH GT 2 and require an Android phone.
- During the stress test, wear your watch correctly and keep still.
- Your watch will be unable to accurately detect your stress level during a workout or when you move your wrist too frequently. In this case, your watch will not carry out a stress test.
- The accuracy of the data may be affected by caffeine, nicotine, alcohol, and some psychotropic medication. In addition, heart disease, asthma, exercise or an incorrect wearing position will also affect the data.
- The watch is not a medical device and the data is for reference only.

4.4 Activity reminder

When **Activity reminder** is enabled, your band will monitor your activity throughout the day in increments (set to 1 hour by default). Your band will vibrate and turn on its screen to remind you to make sure you have a good balance of activity and rest throughout the day.

Disable **Activity reminder** in the Huawei Health app if you find the reminders distracting.

NOTE

- Your band will not vibrate to remind you to move around if you have enabled **Do not disturb** for your band in the Huawei Health app.
- Your band will not vibrate when it detects that you are asleep.
- Your band will only send reminders from 8:00 to 12:00 and from 14:00 to 20:00.

4.5 Enabling HUAWEI TruSleep™

For Android users:

Open the Huawei Health app, touch **Devices**, then touch your device name, and enable **HUAWEI TruSleep™**.

For iOS users:

Open the Huawei Health app, touch **Devices**, then touch your device name, and enable **HUAWEI TruSleep™**.

NOTE

- Enabling **HUAWEI TruSleep™** may reduce the battery life.
- **HUAWEI TruSleep™** is disabled by default.
- The **HUAWEI TruSleep™** tracking will not be affected if your phone powers off while you are asleep.
- Enabling **Do not disturb** in the Huawei Health app will not affect the **HUAWEI TruSleep™** tracking.

5 Watch faces

- [5.1 Changing watch faces](#)
- [5.2 Setting Gallery watch faces](#)
- [5.3 Installing, replacing, and deleting watch faces](#)
- [5.4 Setting a standby watch face](#)
- [5.5 Setting up dual time zones](#)

5.1 Changing watch faces

Method 1: Touch and hold the home screen, and then swipe left or right to choose a watch face.

Method 2: From the home screen press the Up button, go to **Settings > Display > Watch face**, and then swipe left or right to choose a watch face.

Method 3: Open the Huawei Health app, touch **Watch faces** and then **Mine**, choose a watch face as needed, and then touch **Set as default**.

5.2 Setting Gallery watch faces

NOTE

- Only available on Android phones. If you are using iOS, unpair the device, then pair it with an Android phone and follow the instructions to transfer photos. The photos will be saved and you can unpair the device and pair it with your iOS phone again
 - This feature requires that the Health app be updated to version 10.0.0.633 or above and the watch updated to 1.0.1.16 or above.
 - You may not be able to set Gallery Watch faces in certain countries and regions including Australia.
1. Open the Huawei Health app, touch **Devices**, go to **Watch faces > More > Mine**, and touch **Gallery**.
 2. Touch + and choose to either upload an image from your phone's Gallery or take a new photo. Then select your desired image and touch **Save**. Your watch will then display your customized image, as shown in the following figure:

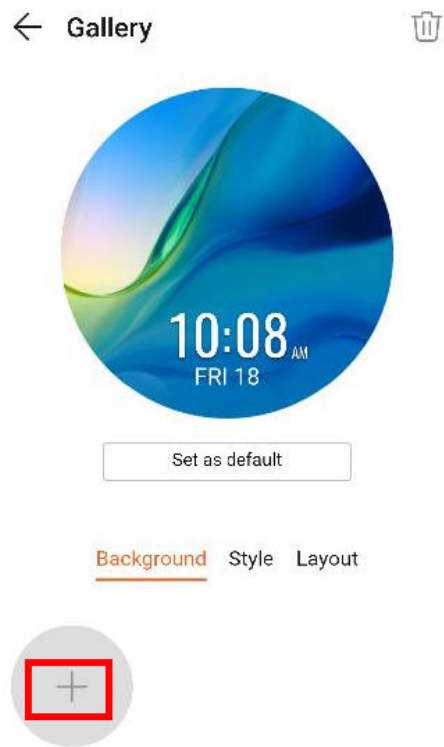

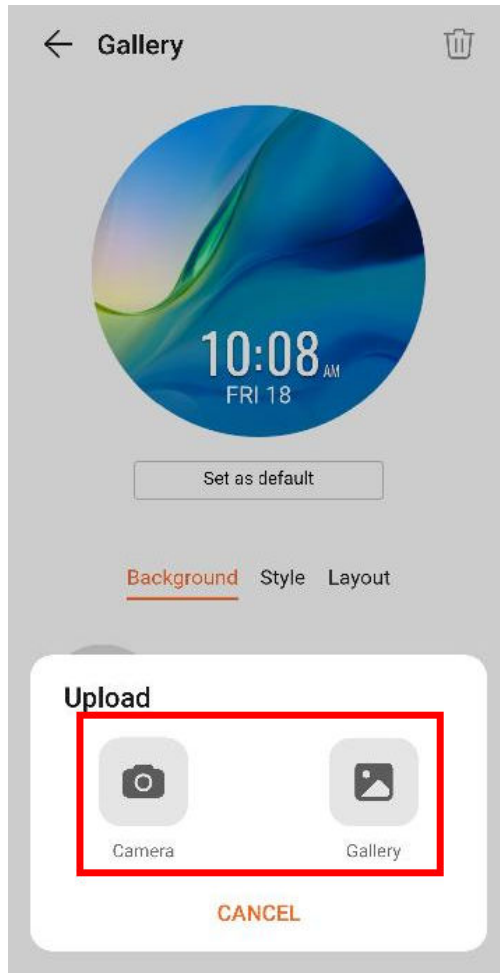

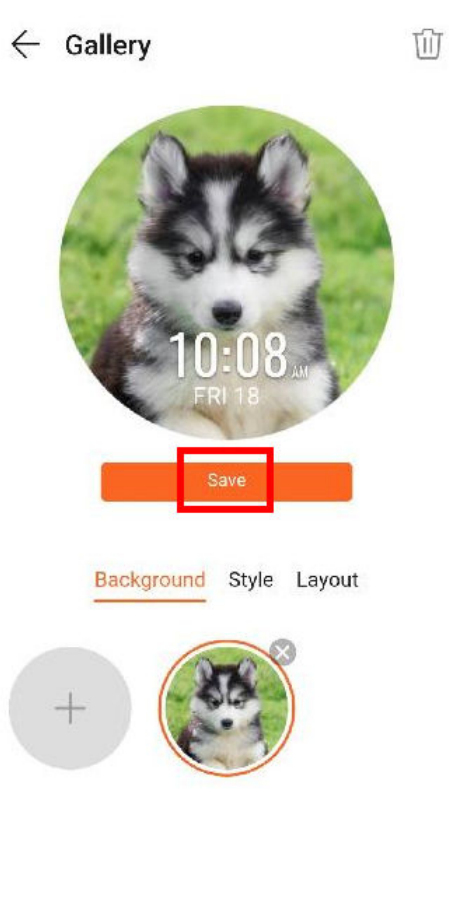

3. On the **Gallery** screen in the Huawei Health app, touch **Style** to customize the font and color of the displayed time and date.
4. Touch **Layout** to adjust the position of the displayed time and date.

NOTE

- Only still images can be used as watch faces. There are no restrictions on the file format
- A maximum of 5 images can be transferred at one. If you transfer multiple images an image will be selected randomly and displayed each time the screen wakes up. You can switch between the images by tapping the screen when it's on.

5.3 Installing, replacing, and deleting watch faces

Download and install even more cool watch faces by performing the following:

1. Open the Huawei Health app and touch your watch name. Go to **Watch faces > More** and see all the watch faces that are supported on your watch.
2. Select your desired watch face and touch **Install**. After the watch face is installed, your watch will automatically display the new watch face.
3. Choose an installed watch face, touch **SET AS DEFAULT**, and your watch will switch to the new one.

Deleting a watch face:

To delete a watch face, open the Huawei Health app, touch **Devices**, touch **Watch faces**,



touch **Mine**, select the watch face you want to delete, touch  in the upper-right corner, and the watch face installed on your watch will then be deleted. Certain preinstalled watch faces cannot be deleted.

NOTE

- You cannot download additional watch faces in the Huawei Health app on an iOS phone. To download new watch faces, you are advised to temporarily pair your watch with an Android phone. When the downloaded watch faces are synced to your watch, pair the watch back with your iOS phone.
- To download or delete watch faces, update your watch and the Huawei Health app to the latest versions.
- You may not be able to download or delete watch faces in certain countries and regions. For more information, contact the local Huawei hotline.

5.4 Setting a standby watch face

When your watch enters standby mode, the standby watch face will be displayed. The standby watch face is disabled by default. To enable this feature, perform the following:

1. From the home screen press the Up button, go to **Settings > Display > Advanced > Standby watch face**.
2. Touch **Style**, choose your preferred style, and then touch **OK**.
3. Touch **Color**, choose your preferred color, and then touch **OK**.

NOTE

- When the watch enters standby mode, touch the standby watch face to switch to the home screen.
- To disable the standby watch face feature, touch **Style** and then choose **None**.
- Enabling the standby watch face feature will drain the battery life by half and disable the Raise wrist to wake screen feature.
- To enable the standby watch face feature, you are advised to update the HUAWEI WATCH GT Classic/Active/Sport to version 1.0.8.34 or later, the HUAWEI WATCH GT Elegant to version 1.0.60.28 or later, or the HONOR Dream/Magic/VIVIENNE TAM to version 1.0.9.4 or later.

5.5 Setting up dual time zones

Touch and hold the watch's home screen to switch designs. Some designs will have a settings icon beneath them. Touch the icon to enable dual time zone display.

6 FAQs

- 6.1 Factors that affect heart rate monitoring
- 6.2 The sleep data on my watch cannot be synced to the Huawei Health app
- 6.3 Detected stress level is inaccurate
- 6.4 How to get more accurate sleep data
- 6.5 Stress level is sometimes unable to display on my watch or takes a long time to display
- 6.6 The heart rate on the watch screen is displayed as "--"
- 6.7 The heart rate on the watch screen refreshes slowly, is inaccurate, or changes rapidly
- 6.8 Heart rate data on the watch is unable to be displayed or is not accurate during swimming
- 6.9 Workout route loss/inaccurate route in open water
- 6.10 The step counts on the watch and the Huawei Health app are not the same
- 6.11 My watch disconnects from my phone automatically or is unable to connect to the phone again once disconnected
- 6.12 My watch screen does not turn on when I raise my wrist
- 6.13 The weather information on my watch is unable to update
- 6.14 Display or control error when playing music on the watch
- 6.15 The positioning on my watch is slow and fails
- 6.16 My watch updates slowly
- 6.17 My watch is unable to update
- 6.18 Unable to find downloaded music in the Huawei Health app
- 6.19 Unable to receive notifications
- 6.20 How to reduce my watch's power consumption

6.1 Factors that affect heart rate monitoring

To avoid inaccurate heart rate monitoring or unsuccessful monitoring, pay attention to the following points:

1. Ensure that the rear side of your wearable device is clean and dry, and is not covered by any foreign objects. The heart rate measurement may be inaccurate when the heart rate monitoring sensor is covered by your sweat during the workout. Wipe the sweat from your wrist and your watch and try again.
2. When measuring the heart rate, ensure that your watch is worn in the right position with its front facing upward and fastened at the back of your wrist. Wear it in the right position for maximum comfort. Make sure the watch is secure on your wrist so that it will not move during the workout, thus increasing the accuracy of the heart rate monitoring.
3. Ensure that your wrist does not move during an individual heart rate measurement. This can help your watch to obtain a more stable and accurate heart rate data reading.
4. The displayed heart rate measurement data may change significantly after you have carried out strenuous exercise. This is because your heart rate may decrease significantly after finishing the strenuous exercise, and does not indicate an issue with your wearable device.
5. It is easier for your wearable device to measure your heart rate when you do exercise with regular movements such as running, walking, and cycling. The heart rate measurement may deviate when you do exercise with irregular movements such as ball games or when you do strength training such as weight lifting.
6. Multiple measurements of your heart rate within a short period in the same environment may affect the heart rate test depending on your talking, your mood, breathing and changes in the way you wear your watch.
7. If you are a sports lover, it is recommended that you wear a strap made of silicone rubber so that the strap is in good contact with your wrist and can obtain more accurate data.

*If the issue persists, bring your device and the proof of purchase to an authorized Huawei Customer Service Center for assistance.

6.2 The sleep data on my watch cannot be synced to the Huawei Health app

1. Check whether your watch has recorded any sleep data.

If your watch has not recorded any sleep data, this could be because your wrist or arm was moving too much while you were asleep so your watch was unable to recognize that you were asleep. As a result, no sleep data was recorded. To prevent this from happening, try wearing your watch on your non-dominant hand while sleeping (on your left hand if you are right-handed, and vice versa).

If you take a nap in the afternoon for a short period of time and have not enabled HUAWEI TruSleep™, your watch may not be able to detect that you are sleeping and therefore fail to record the sleep data.

2. If the sleep data is displayed on your wearable device but the TruSleep data is unable to sync to the Huawei Health app, check whether you have enabled HUAWEI TruSleep™ in the Huawei Health app. To do this, perform the following:

For Android users: Open the Huawei Health app, touch **Devices**, touch the connected device, and then enable **HUAWEI TruSleep™**.

For iOS users: Open the Huawei Health app, touch **Devices**, touch your device name, and then enable **HUAWEI TruSleep™**.

3. If you have enabled HUAWEI TruSleep™ but this issue still persists, perform the following to troubleshoot:

(1) Turn on your watch screen, then swipe down on the **Health** screen of the Huawei Health app to sync data.

(2) The size of the TruSleep data is usually large, so it may take a while for the data to sync automatically. It is recommended that you sync data manually in the Huawei Health app. To do this, open the Huawei Health app, go to **Me > Settings**, then touch **SYNC** (for Android users).

(3) Currently, only sleep data that is longer than 3 hours can be counted as TruSleep data. Sleep data that is shorter than 3 hours will be counted as naps.

(4). Sleep data synchronization is not supported during 12 - 6 AM and can only be synced after 6 AM.

(5) HUAWEI TruSleep™ works based on the analysis of your heart rate. If you are wearing the wearable device too loosely or tightly while you are asleep, your wearable device may be unable to collect your heart rate data. It will therefore be unable to sync data to the Huawei Health app. You are advised to adjust the strap of the device to fit your wrist before sleeping.

(6) If the issue persists, restart your wearable device and check whether the issue is resolved.

Note:

When HUAWEI TruSleep™ is enabled, it will take longer to sync sleep data. You can also choose to sync the data manually. To do this, open the Huawei Health app, go to **Me > Settings**, then touch **SYNC** under **Sync data manually**. It is recommended that you manually sync data every day.

Only your TruSleep data (sleep that lasts longer than 3 hours) displayed in the sleep details. Sleep that lasts less than 3 hours will be counted as naps. As a result, sleep data displayed on your wearable device is an accumulative result of your TruSleep data and nap data.

6.3 Detected stress level is inaccurate

Perform the following to troubleshoot:

1. When using the Huawei Health app or switching to use another HUAWEI ID, open the Huawei Health app, touch **Stress**, and then go to **More > Calibrate**.

2. During the measurement, wear the watch properly and keep your body still.

3. Please note that the detected stress level may be affected by caffeine, nicotine, alcohol, and some psychotropic substances, or by variations caused because of heart disease, asthma, exercise, or the position of the watch when worn by the user.

Note: Huawei's stress detection technology works based on HRV (heart rate variability) to sense the activity of sympathetic and parasympathetic nerves and to estimate your stress status and degree based on the corresponding stress calculation model. Huawei's stress testing technology is jointly developed by Huawei and the Institute of Psychology of the Chinese Academy of Sciences, and has passed the authoritative test certification by the Institute of Psychology of the Chinese Academy of Sciences.

When using this function for the first time, you need to complete 10 psychological questions in a questionnaire. To ensure the accuracy of the test result, you need to read the questions carefully and answer truthfully. In addition, you are advised to pay attention to the upward and downward trend of pressure to control your pressure and avoid an impact on your health. Your watch is not a medical device, and the test results and suggestions are for reference only.

6.4 How to get more accurate sleep data

Your watch determines your sleep status by detecting your wrist movement when you are asleep. As a result, sleeping data recorded may vary with wearing habits and individual activities. If the sleep data is inaccurate, it is recommended that you wear your device at the back of your wrist. Do not place your watch over the bone in your wrist, as this may result in you wearing the device incorrectly as well as inaccurate sleep data. When you are not using your wearable device for a while, turn it onto its side and place it on a flat surface to minimize any inaccurate sleep data being recorded. Power off your wearable device if you do not use it for a long time.

1. Missing sleep data

This could be because there is too much wrist movement when you were asleep so that your watch does not recognize that you are sleeping. As a result, no sleep data was recorded. It is recommended that you wear the watch on your non-dominant hand while sleeping (on your left hand if you are right-handed).

If your lunchtime nap is less than 30 minutes, or you have moved a lot during the nap, your watch may not be able to detect this sleep time, and will not record this sleep data.

If you are wearing the watch too loosely while HUAWEI TruSleep™ is enabled, sleep data may not be recorded. Ensure that you wear the device that is fastened correctly.

If you are traveling and sleeping on modes of transportation such as a metro, bus, or train, the acceleration or jerky movements onboard the vehicle may affect the sleep data.

2. Increase in sleep data when wearing the watch

When the wearable device detects minimal wrist movements similar to those while you are asleep, these movements will be incorrectly recorded as you being asleep, even if you are awake at the time. For example, you may not move around much when you watch TV or use your tablet. During this time, the wearable device may think that you are sleeping and incorrectly record these movements as sleep data.

If you do not perform any operations on the device screen for a period of time or do not move, the device may still be in Sleep mode.

3. Increase in sleep data when not wearing the watch

Your watch determines whether it is being worn using its built-in PPG sensor, which reflects light off your skin. The built-in sensor in the wearable device usually detects light reflected from human skin at different wavelengths. When the wearable device is placed on surfaces

such as a desk, sofa, or quilt with the sensor facing down, light reflected from these surfaces may be similar to that from human skin. In this case, the wearable device may think that you are wearing the device, and start recording sleeping data.

4. Number of recorded wake times is inaccurate

If you turned over or accidentally touched the wearable device screen multiple times when you were asleep, the device may exit Sleep mode and increase the number of wake times based on the movements detected.

If you do not move around much after waking up, the wearable device may still be in Sleep mode and the actual wake time will not be recorded.

6.5 Stress level is sometimes unable to display on my watch or takes a long time to display

Your watch measures your stress once every 30 minutes, and tends to be unable to accurately measure your stress level due to unreadable heart rate data during a workout or if your wrist is moving a lot. To help you accurately measure your daily stress level, your watch automatically measures your stress level when you are still for a long time. If you want to view your stress level in a timely manner, you can start an individual stress test in the Huawei Health app.

6.6 The heart rate on the watch screen is displayed as "--"

To resolve this, perform the following:

1. Ensure that you have enabled **Continuous heart rate monitoring** for your watch in the Huawei Health app.
2. If you have set **MONITORING MODE** to **Smart** in the Huawei Health app, turn on your watch screen and wait for 10 seconds, and check whether the heart rate is now displayed properly.
3. Replace the watch face with one that can display the heart rate and check whether the heart rate is now displayed properly.

If this issue persists, bring your device and proof of purchase to an authorized Huawei Customer Service Center for assistance.

6.7 The heart rate on the watch screen refreshes slowly, is inaccurate, or changes rapidly

If you have set **MONITORING MODE** to **Smart** in the Huawei Health app, it is normal that you encounter the following issues and this does not indicate an issue with your watch.

The heart rate refreshes slowly: Your watch will start measuring your heart rate each time the watch screen is turned on. It will take a few seconds for the heart rate reading to update.

The heart rate is inaccurate or changes rapidly: The accuracy of the first few heart rate data readings may be affected by the signal variation each time that the watch screen is turned on. It is recommended that you wait for a few seconds before checking the heart rate data. If you

do some high intensity activities before the screen is turned on again, the displayed heart rate may change rapidly due to the changes in your heart rate.

If you want to prevent these issues from occurring, set **MONITORING MODE** to **Real-time** in the Huawei Health app. Please note that doing this will increase the power consumption of your watch.

6.8 Heart rate data on the watch is unable to be displayed or is not accurate during swimming

Wipe the back of your watch and wear the watch securely, and try again.

Your watch monitors your heart rate by using its PPG sensor which works by detecting the light wavelength changes reflected by your skin. It may not be possible to detect light in some scenarios when measuring your heart rate underwater, such as when you are swimming in open water that may not be clean. In this case, it may result in the heart rate measurement being unable to be displayed or inaccurate.

6.9 Workout route loss/inaccurate route in open water

For outdoor swimming sessions, your watch uses GPS positioning to record your workout track and distance. During swimming, you need to make sure the watch comes out of the water regularly to update the GPS signal. Otherwise, the distance and route data may be inaccurate or incomplete.

It is recommended that you use the freestyle stroke so that your wrist will be out of water regularly, thus enhancing the accuracy of the displayed workout track.

Note: Open water mode supports swimming in outdoor open water areas such as in a lake, river or ocean. Pool swim mode does not support swimming in open water, which means that you will not be able to record your swimming route in this situation. It is recommended that you select the right swimming mode.

6.10 The step counts on the watch and the Huawei Health app are not the same

This is because the step count displayed in your Huawei Health app is calculated using data collected from all connected wearable devices and your phone with the same HUAWEI ID, whereas the step count on your watch only uses data collected by your watch. To view the step count recorded by your wearable device, touch the corresponding device and check the step count under **WEARABLE DEVICE FITNESS DATA**.

6.11 My watch disconnects from my phone automatically or is unable to connect to the phone again once disconnected

Configure the settings on your watch and in the Huawei Health app by performing the following:

1. Update your watch and the Huawei Health app to the latest versions.
2. Enable Bluetooth on your watch and your phone.
3. Enable GPS on your phone and the Location permission for the Huawei Health app.
4. Open the Huawei Health app and check whether your watch can connect to your phone using the app. If the watch can connect automatically, this issue may have occurred because the Huawei Health app is not running in the background. If you are using an Android phone, enable **Auto-launch** and **Run in background** for the Huawei Health app on your phone.
5. If the watch cannot connect automatically, open the Huawei Health app, touch **Devices**, and then touch **Associate** under **MY DEVICES**.

If you are unable to connect your watch to the phone using the Huawei Health app, perform the following:

- (1) Disable and then enable Bluetooth on your phone and connect the two devices again.
- (2) Restart your watch and connect the two devices again.
- (3) Restart your phone and connect the two devices again.
- (4) Open the Huawei Health app, go to **Me > Settings > Notification management** and enable **Show step count in notification panel**.
- (5) Unpair your watch from the phone using the Huawei Health app and then pair them again.
- (6) If the issue persists, restore your watch to its factory settings. Check whether there is already a paired watch in your phone's Bluetooth list. If so, remove the paired watch and try again.

6.12 My watch screen does not turn on when I raise my wrist

1. Check that you have enabled **Raise wrist to wake screen** for your watch in the Huawei Health app.
2. Check that you have not enabled **No Disturb** on your watch or have not set any schedules under **Do not disturb** on your watch. Please note that your watch will not wake up its screen when you raise your wrist when **No Disturb** is enabled. To check if it is enabled, perform either of the following methods:

Method 1: Swipe down on the home screen of your watch.

Method 2: On your watch, go to **Settings > Do not disturb**.

3. Your watch may not exit Sleep mode when you wake up. It is recommended that you press either buttons on your watch or move your wrist to exit Sleep mode, and try again.
4. Raise wrist to wake screen is not available when a standby watch face is used.

6.13 The weather information on my watch is unable to update

Perform the following to troubleshoot:

1. Ensure that you have granted the Location permission for the Huawei Health app and have enabled **Weather reports** for your watch in the Huawei Health app.
2. Ensure that your phone has a stable network connection. The weather information in the Huawei Health app updates once an hour and will not update in a timely manner when the network connection is poor.
3. Ensure that your phone has obtained the Location permission. Your phone may be unable to obtain the real-time location information if you are indoors. It is recommended that you go to an open area and try again.
4. If the weather information cannot update when connected to Wi-Fi, try using the 4G network.
5. Try disabling **Weather reports** in the Huawei Health app and then enabling it again, and check whether this resolves the issue.

6.14 Display or control error when playing music on the watch

When playing music on your watch from a third-party music app on your phone, it is normal for you to encounter an abnormal display on the music screen of your watch or for you to be unable to control the music that is being played using your watch. This issue can only be resolved after the optimization of the third-party music app.

It is recommended that you add the Huawei Health app to the protected list on your phone. For how to do this, refer to the user guide of your phone or consult your phone manufacturer for assistance.

6.15 The positioning on my watch is slow and fails

GPS positioning can be directly affected by various environmental factors, including obstructions from high-rise buildings, surface reflections from oceans and lakes, and interference from metal objects, all of which may affect the reception of GPS signals and delay the positioning of your watch. 1. It is recommended that you exercise in an open area with less interference and fewer obstructions.

2. If you are using your watch's built-in GPS, it is recommended that you maintain the Bluetooth connection between your watch and the phone for at least five minutes, or swipe down on the **Health** screen of the Huawei Health app and ensure that Wi-Fi or mobile data works properly on your phone.

3. For a better user experience, it is recommended that you connect your watch to a Huawei phone running EMUI 5.0 or later or iOS 9.0 or later for positioning during an outdoor workout when you use your watch for the first time.

6.16 My watch updates slowly

1. Before updating, please ensure that the battery of your wearable device is sufficiently charged (50% or higher).

2. The length of time required to finish the update is closely related your phone's network condition. Please make sure you have a stable network condition when using mobile data or Wi-Fi.

(3) OTA updates need your phone and the wearable device to be well connected. The time it takes to update is related to the new version that needs to be downloaded and the Bluetooth transfer rate (in normal situations this can be completed within 15 minutes). In some situations, the update time will be longer. Thanks for your patience during the update. Do not try to use the wearable device or the Huawei Wear app during the update.

4. After the installation package is transmitted from the Huawei Health app to the watch, the watch needs to decompress and install the update package. The watch will display the update animation (arrow or circle). Thanks for your patience during the update. This watch will restart after the update package is installed.

6.17 My watch is unable to update

1. Your watch may be unable to update if the Huawei Health app is cleared from your phone's background. To resolve this, open the Huawei Health, reconnect it with your watch, and then try again.

2. If there is a message from the Huawei Health app prompting you that the update has failed, connect your watch to the Huawei Health app, and try again. Make sure that your phone has a stable network connection during the update.

3. If the issue persists, update your watch using another phone, then reconnect the watch to the original phone.

6.18 Unable to find downloaded music in the Huawei Health app

Your watch only supports music in mp3/LC_AAC format. If you have downloaded music in another format, you will not be able to find the music in the Huawei Health app. Please download the music in the correct format and try again.

6.19 Unable to receive notifications

Perform the following to troubleshoot:

1. Check whether your phone and your watch are running the latest versions. If not, update them to the latest versions.
2. Check that your watch is connected to your phone via Bluetooth, and data between the two devices can be synced properly using the Huawei Health app.
3. Check that the notification feature is enabled for your watch in the Huawei Health app, and the push notifications feature is enabled for corresponding apps that you want to receive messages from.
4. Check that you have disabled No Disturb on your watch, and you are wearing your watch. Your watch will not vibrate to notify you of new messages when No Disturb is enabled. To check whether you have enabled No Disturb, swipe down on the home screen of your watch.

5. Your watch can only remind you of notifications that are displayed on the status bar. In this case, ensure that you have enabled notifications to be displayed in the status bar. Perform the following to do this:
For Android users (taking EMUI 9.X as an example): On your phone, go to **Settings > Notifications**, select the app and then enable **Allow notifications, Display in status bar, Banners, and Lock screen notifications**.
For iOS users: On your phone, go to **Settings > Notifications**. Touch the apps that you want to receive notifications from and then enable **Allow Notifications**.
6. Add the Huawei Health app to the protected app list. To do this, perform the following:
For Huawei users (taking EMUI 9.X as an example): Open Optimizer, touch **App launch**, and then enable **Health**. Then, go to **Settings > Battery** and keep the Huawei Health app running the background when the phone is locked. If you cannot find the Huawei Health app in Optimizer, it indicates that the app has been automatically added to the protected list. In this case, check whether you have installed other third-party phone management apps on your phone such as Tencent Mobile Manager, QQ Phone Manager, or 360 Phone Manager. If so, add the Huawei Health app to the protected list using the third-party phone management app.
For non-Huawei users: The actual configuration method may vary with models. It is recommended that you consult your phone manufacturer for assistance.
7. If you are using a Huawei or Honor phone, ensure that you do not mistakenly clear the Huawei Health app from the background. To prevent this from happening, touch the Recent task key, find the Huawei Health app or touch the lock icon.
8. If the issue persists, restart your phone and connect it to the watch, and try to see whether you can now receive notifications.

6.20 How to reduce my watch's power consumption

1. Lower the screen brightness on your watch. On your watch, go to **Settings > Display > Brightness** and set **Brightness** to **Auto**. Alternatively, lower the screen brightness in a bright environment.
2. Disable **Raise wrist to wake screen** for your watch in the Huawei Health app to lower the frequency of your watch screen turning on.
3. Do not use the built-in GPS on your watch during an outdoor workout. To do this, connect your watch to a phone running EMUI 5.0 or iOS 9.0 during the outdoor workout.
4. If you want to use the built-in GPS on your watch, try doing the workout in an open area, which will reduce power consumption when GPS is working.
5. Set **MONITORING MODE** under **Continuous heart rate monitoring** to **Smart**. Setting it to Real-time will increase the power consumption.
6. Disable the push notifications feature for apps that you do not need to receive messages from in the Huawei Health app.
7. Disable **Bluetooth disconnection reminder** in the Huawei Health app.
8. Try using the default watch face. Some watch faces have high brightness levels that increase power consumption.
9. Try not to use a watch face that supports heart rate monitoring, as this will increase power consumption. It is recommended that you set **MONITORING MODE** under **Continuous heart rate monitoring** to **Smart** during the workout.

10. When playing music or making a call via Bluetooth on your watch, your watch's power consumption may vary depending on the music that is playing and the duration or volume of the call made via Bluetooth.
11. Your watch may consume more power when you have enabled Automatic stress test. After this feature is enabled, your watch will determine your active status and monitor variations in your heart rate.
12. The battery life of your watch will reduce by half when you use a standby watch face.
13. Enable **No Disturb** when you are having a rest, reducing the power consumption caused by screen on and notifications.