

VS01

Keypad Digital Deadbolt

Installation Guide / Programming Instructions

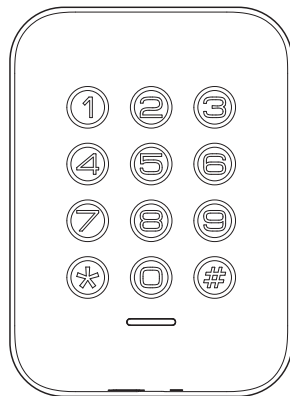

Thank you for purchasing our products. Please review this manual thoroughly before operating your device. All pictures in this manual are for illustration purpose only. Actual product may vary due to product upgrade.

Installation Overview

⚠ Read this manual carefully before installing and operating!

P 3	STEP 1: Prepare the door and check dimensions
P 4	STEP 2: Install the latch and strike
P 6	STEP 3: Install exterior assembly
P 7	STEP 4: Install interior assembly
P 8	STEP 5: Detect left/right hand door installation

Programming Instructions

P 9	At a Glance	P 15	Factory Default Settings
P 10	How to Use	P 16	Troubleshooting
P 11	Definitions		
P 12	Code Format		
P 13	Quick Set Up		

TOOL REQUIRED:



Do not use an electric screwdriver during installation.

IMPORTANT:







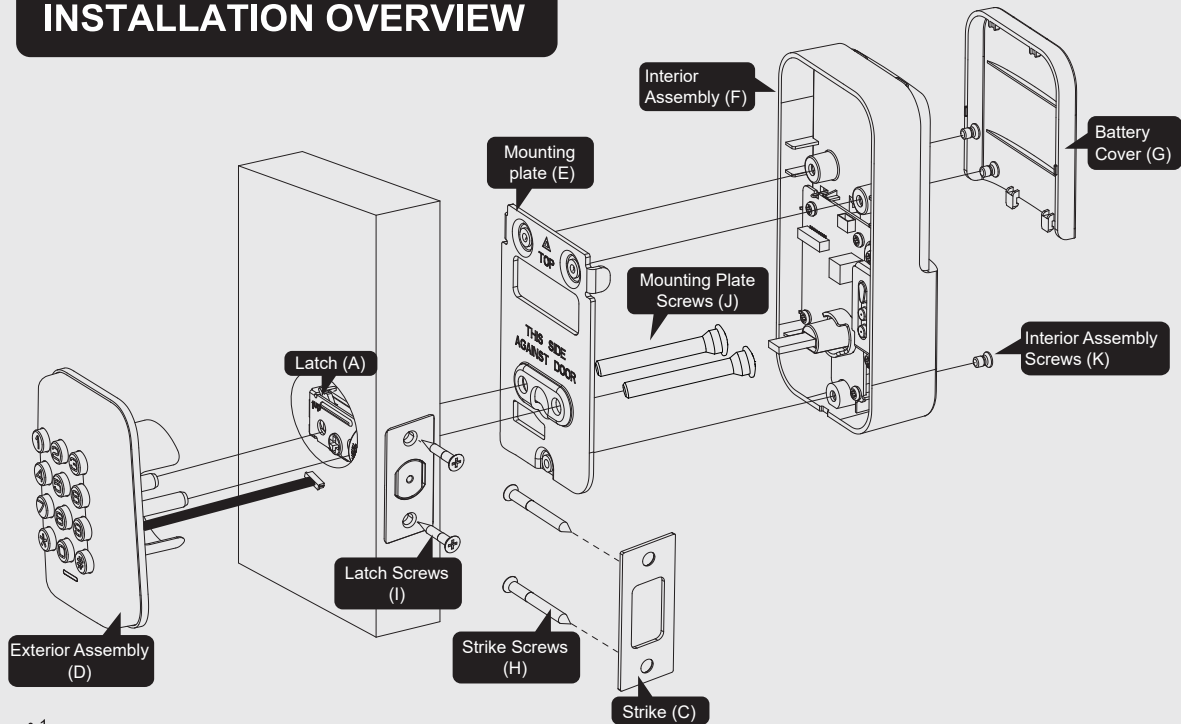



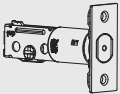
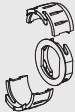

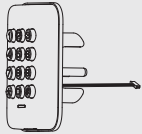
Do not load batteries until lock is completely installed.

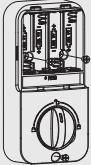
INSTALLATION OVERVIEW



Parts List

<p>A Latch x1</p> 	<p>B Drive-In Collar (Optional)</p> 	<p>C Strike x1</p> 	<p>D Exterior Assembly x1</p> 
<p>E Mounting Plate x1</p> 	<p>F Interior Assembly x1</p> 	<p>G Battery Cover x1</p> 	<p>H Strike Screws x2</p>  <p>I Latch Screws x2</p> 
<p>J Mounting Plate Screws x2</p> 	<p>K Interior Assembly Screws x3</p> 	<p>L Reset Tool</p> 	<p>If any parts are missing or damaged, please contact Customer Support.</p>

1 Prepare the door and check dimensions

A

Measure to confirm that the hole in the door is 2-1/8" (54mm).

Measure to confirm that the hole in the door edge is 1" (25mm).

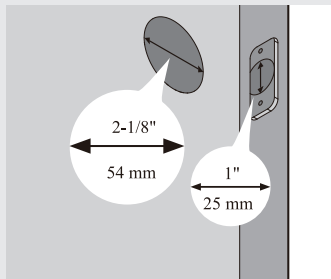

B

Measure to confirm that the backset is either 2-3/8" or 2-3/4" (60 or 70mm)

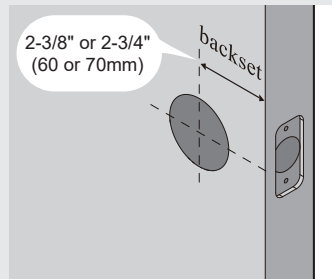

C

Measure to confirm that the door is 1-3/8" to 2" (35 mm or 50mm) thick.

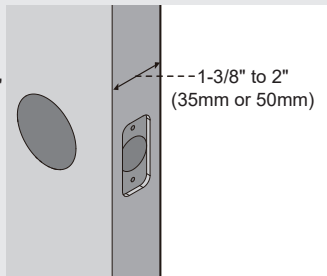

D

Make sure the hole in door frame is drilled a minimum of 1" (25mm) deep.

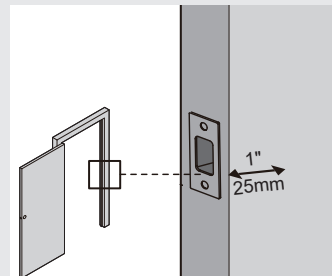

2 Install the latch and strike

A Determine backset and adjust the latch

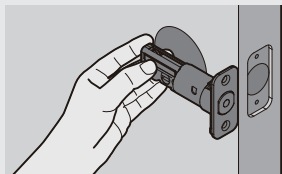

Hold the latch in front of the door hole, with the latch face flush against the door edge. Is the slotted hole centered in the door hole?

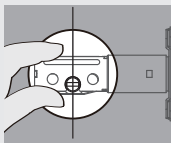

YES

No adjustment is required.
Proceed to next step.

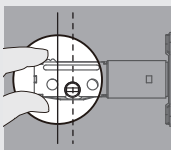

NO

Slotted hole is NOT centered.

Rotate and pull the latch as shown to extend latch.

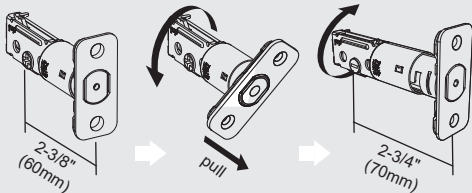

B

Install the latch

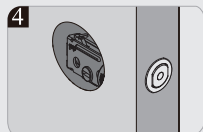
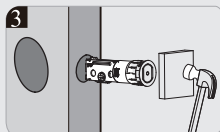
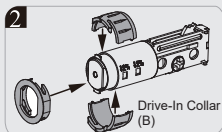
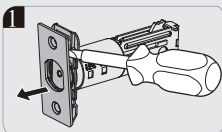
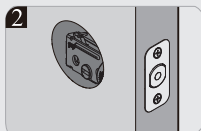
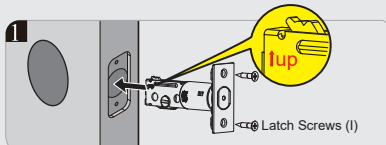
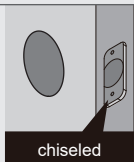

- C Use a screwdriver to test if deadbolt works smoothly.

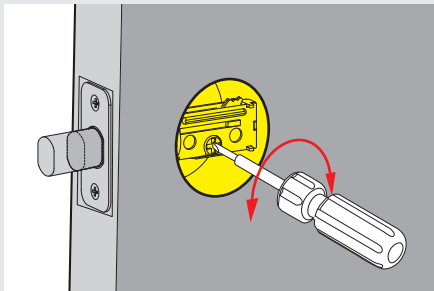

- D Install strike on the door frame.

! IMPORTANT:

Make sure the hole in door frame is drilled a minimum of 1" (25mm) deep.

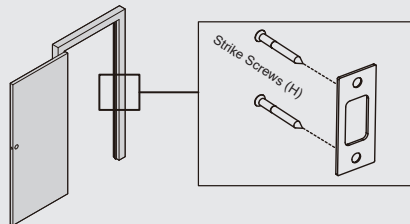

3 Install exterior assembly



IMPORTANT:

Before installation, make sure the latch is fully retracted (in the unlocked position)

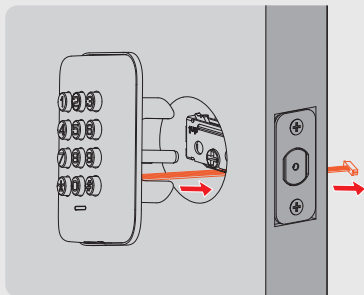
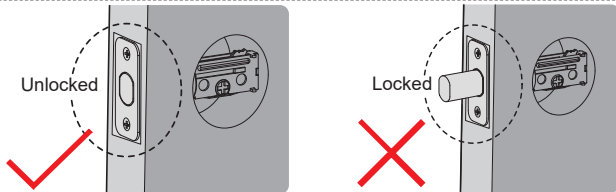

- A** With the latch fully retracted (in the unlocked position), route the cable below the latch.

Keep parallel to door edge.

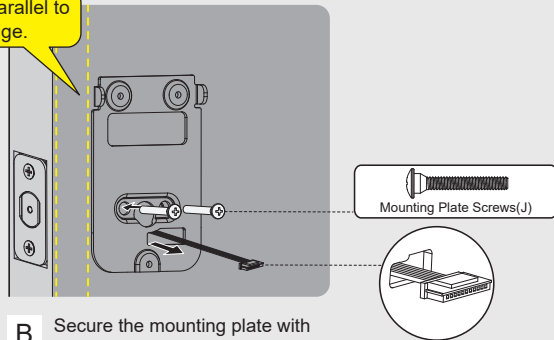

- B** Secure the mounting plate with the supplied screws. Do not overtighten screws.

4 Install interior assembly

A

Push the battery cover out in the direction as illustrated.

IMPORTANT:

Do not load batteries until lock is completely installed.

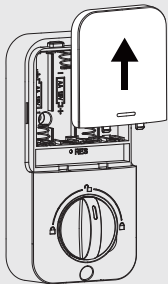

B

Insert the cable connector to the socket. Push the connector in firmly until it is completely attached.

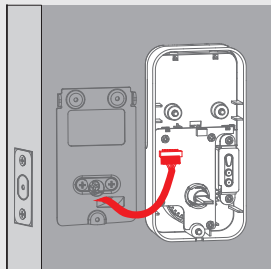

C

Keep the thumb turn in vertical position and install the interior assembly.

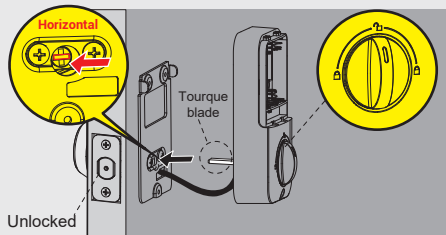

D

Attach Interior Assembly to Mounting Plate and tighten 3 Screws.

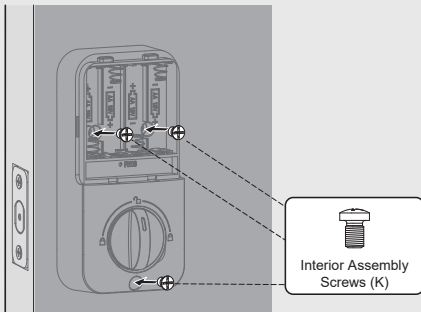

5 Detect left/right hand door installation

Reset the lock to teach the lock the orientation of the door.

**IMPORTANT:**

This step is required and crucial for the lock to operate properly.

- A** While the door is **OPEN** and **UNLOCKED**, load 3 AA batteries into the battery compartment.

Note:

For long last, please use all new, non-rechargeable Alkaline batteries only.

- B** Press and hold the Reset button on the interior assembly by using the reset tool.

- C** Load the **4th** battery and keep holding the reset button for 3 seconds, until you hear the sound of "beep". The latch bolt will extend to learn the orientation of the door automatically.

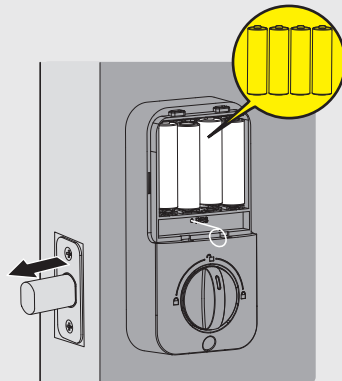
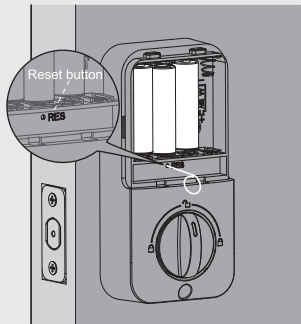
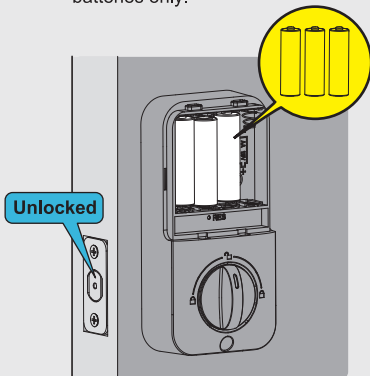

PROGRAMMING INSTRUCTIONS

At a Glance

Exterior Assembly

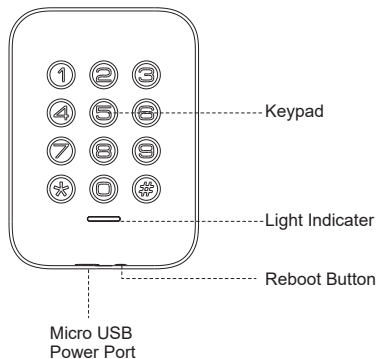

Interior Assembly

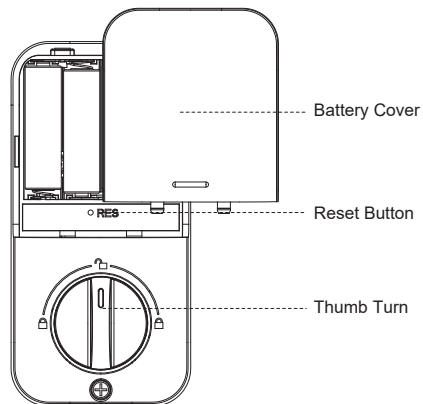

How to Use

UNLOCK the door from outside



LOCK the door from outside

Auto Lock Mode

In Auto Lock mode, the bolt will extend out automatically in 30 seconds after unlocking.

Manual Mode

Press any key on keypad for 2 seconds.



UNLOCK the door from inside

Rotate the thumb turn to Unlock position.



LOCK the door from inside

Auto Lock Mode

In Auto Lock mode, the device will be locked automatically.

Manual Mode

Rotate the thumb turn to Lock Position.

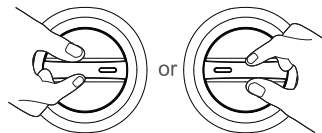

• **Master Code**

Required for programming and feature settings. Master code can be used to unlock the door under vacation mode. The default master code needs to be changed before programming.

Property owner & manager should keep this information confidential.

• **Auto Lock**

Automatically locks the deadbolt 30 seconds after unlocking. This feature is off by default. You can customize the Auto Lock time delay between 10 and 99 seconds.

• **Low Battery Indicator**

If you hear 10 beeps along with 10 red light flashing after pressing any key to lock or unlock the door, that's an alert for replacing batteries. Please replace with 4 brand new AA alkaline batteries and do not mix used and new batteries. All settings are stored in the lock while the batteries are removed and replaced.

• **Wrong Entry Limit**

After 10 unsuccessful attempts at entering a invalid PIN code, the unit will shut down for 3 minutes.

• **Silent Mode**

The beep sounds when pressing keypad can be muted. But you will still hear low battery and system alerts.

• **Vacation Mode**

This is a security feature for you when you are leaving your home for vacation or long trip. Enabling vacation mode will restrict all user codes until master code is entered on keypad. If the lock would be unlocked by the thumb turn from the inside, the lock will sound an alarm.

• **One Time User Code**

This code only can be used once and will be automatically deleted after used.

• **Unlock with Fake code**

User can prevent pin code exposure from strangers by entering random digits before or after pin code.

83618 137192 14710

 password

 Random digits

1. Master Code(4 to 10 digits): The default Master Code is **12345678**. It is required that you change it to a code of your own before programming.
2. User Code: 20 User Codes (4-10 digits), 1 one-time User Code can be programmed and stored in the lock.
3. Both Master Code and User Code don't support the following combination of numbers.

- A.

1	2	3	4	5	6	7	8	9
---	---	---	---	---	---	---	---	---

 ✗ Forward number sequence
- B.

9	8	7	6	5	4	3	2	1
---	---	---	---	---	---	---	---	---

 ✗ Backward number sequence
- C.

2	2	2	2	2	2	2	2	2	2
---	---	---	---	---	---	---	---	---	---

 ✗ Repeat number sequence
- D. If

5	6	8	3
---	---	---	---

 ✓
- Then

5	6	8	3	9	1
---	---	---	---	---	---

 ✗ Contain existing code sequence
- and

9	1	5	6	8	3
---	---	---	---	---	---

 ✗

Quick Set Up



IMPORTANT:

The default Master Code is **12345678**. It is required that you change it to a code of your own before programming.

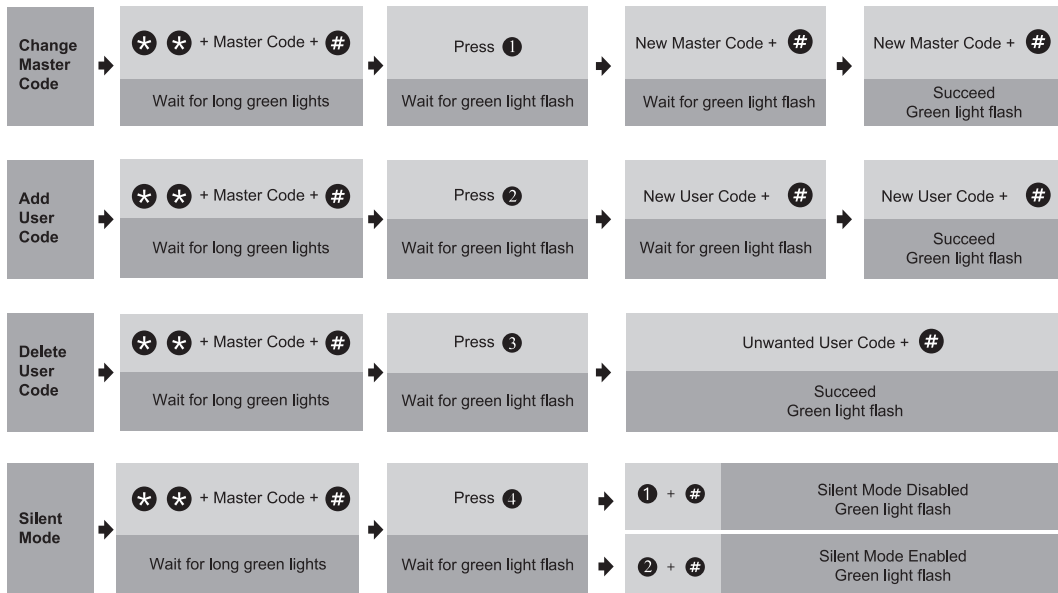

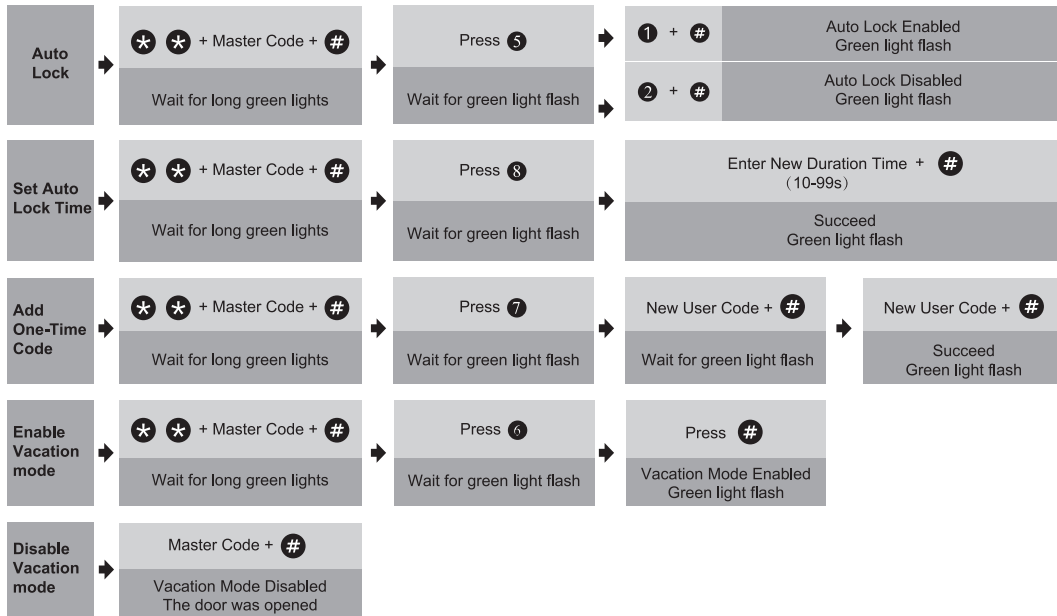

Notes:

1. Beeps only sound when the Silent Mode is disabled.
2. If the indicators flash red light, it means your setting failed and it will require to re-enter master mode if you would like to continue your programming.

Factory Default Settings

How to Reset?



IMPORTANT: The resetting will delete all User Codes stored in the lock.

- Step 1.** Keep the door open and unlocked.
- Step 2.** Press and hold the Reset button, at the same time take out one battery and then place it back.
- Step 3.** Keep holding the Reset button for 3 seconds, until you hear the sound of "beep" and the latch will extend automatically.

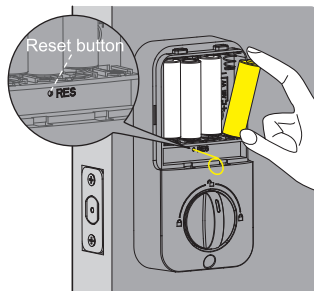

Settings	Factory Default
Master Code	12345678
Auto Lock	Disabled
Silent Mode	Disabled
Wrong Code Entry Limit	10 times
Shutdown Time	3 mins
Vacation Mode	Disabled

Troubleshooting

Why does not the latch extend but the motor is rotating when resetting my lock?

Improper installation may have caused the issue. Please follow the steps to review:

1. Please make sure the latch and strike are aligned.
2. Please slightly loosen the mounting screws on the external assembly keypad and the latch bolt if the screws are over-tightened.
3. Please open your door and reset the lock.

Why does not the latch extend and the motor isn't rotating when resetting my lock?

The deadbolt latch should be retracted(unlocked) through all your installation process.

The thumb turn should be vertical in your installation steps 4C and 5A.

Please open your door and reset the lock.

When I attempt to lock/unlock my deadbolt, why does the latch go in and out for a few times?

It happens when the latch and strike are misaligned.

Please make sure the bolt hole on the door frame is at least 1 inch deep, so that the bolt can be fully extended.

Please check if the door can be closed properly, the deadbolt should not impact the strike or door frame on the door frame side, it should go directly into the hole properly.

What does 5 short and fast beeps mean while programming?

It alerts you either time-out or wrong entry.

Please be sure to complete each setting step within 5 seconds.

Please change the default master code in the first time programming.

Please be sure the user code is with correct format and with 4 to 10 digits.

What if I forget my Master Codes?

If you forget your Master code, resetting your lock, then the original master code (12345678) works, and all previous user codes were erased.

Information & Safety Warnings

- Protect your User Codes and Master Code.
 - Restrict access to your lock's interior assembly and routinely check your settings to ensure they have not been altered without your knowledge.
 - Do not use an electric screwdriver during installation.
 - This manufacturer advises that no lock can provide complete security by itself.
 - This lock may be defeated by forcible or technical means, or evaded by entry elsewhere on the property.
 - No lock can substitute for caution, awareness of your environment, and common sense.
- Care should be taken to ensure a long-lasting finish. When cleaning is required use a soft, damp cloth. Using lacquer thinner, caustic soaps, abrasive cleaners or polishes could damage the coating and result in tarnishing.
 - The lock is water resistant. It can withstand water splashes; however, do not let water and liquids get into the lock.
 - Avoid exposure to direct sunlight. Long-term exposure to direct sunlight may damage the lock.