



USER MANUAL

Core 300 series, Core 300-P series

Air Purifier

Models: Core 300, Core 300-RAC

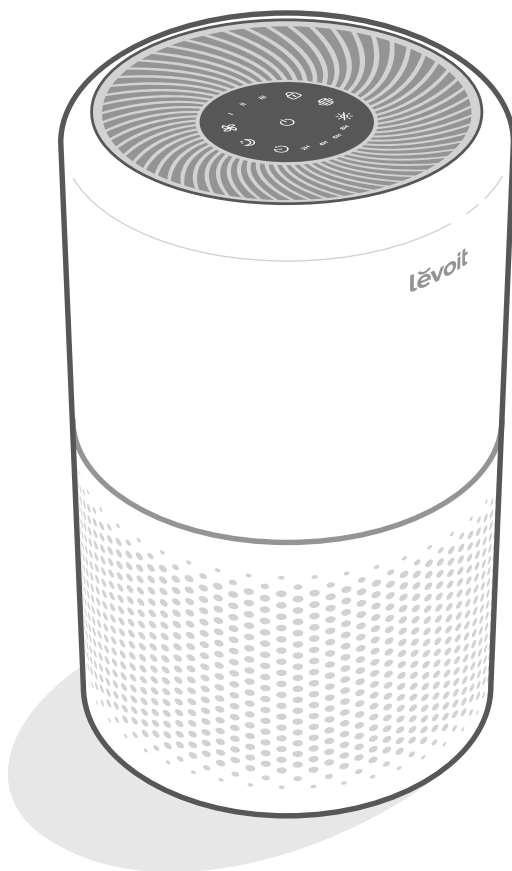

Questions or Concerns?

Please contact us Mon–Fri, 9:00 am–5:00 pm PST/PDT at support@levoit.com or at **1-888-726-8520**.

Table of Contents

Package Contents	2
Specifications	2
Safety Information	3
Getting to Know Your Air Purifier	5
Controls	6
Getting Started	7
Using Your Air Purifier	8
About the Filter	10
Levoit Replacement Filters	10
Care & Maintenance	11
Troubleshooting	13
Warranty Information	16
Customer Support	18

Package Contents

- 1 x Air Purifier
- 1 x Pre-Installed Original Filter
- 1 x User Manual
- 1 x Quick Start Guide

Specifications

Power Supply	AC 120V, 60Hz
Rated Power	56W
Operating Conditions	Temperature: 14°–104°F / -10°–40°C
	Humidity: < 85% RH
Noise Level	24–54.5dB
Dimensions	8.7 x 8.7 x 14.2 in / 22 x 22 x 36 cm
Weight	7.9 lb / 3.6 kg

READ AND SAVE THESE INSTRUCTIONS

SAFETY INFORMATION

To reduce the risk of fire, electric shock, or other injury, follow all instructions and safety guidelines.

General Safety

- **Only** use your air purifier as described in this manual.
- **Do not** use without removing the plastic wrap from the filter. The air purifier will not filter air, and may overheat, causing a fire hazard.
- **Do not** use your air purifier outdoors.
- Keep your air purifier away from water, and wet or damp areas. **Never** place in water or liquid.
- **Do not** use in excessively humid areas.
- Keep your air purifier away from heat sources.
- **Do not** use where combustible gases, vapors, metallic dust, aerosol (spray) products, or fumes from industrial oil are present.
- Keep 5 ft / 1.5 m away from where oxygen is being administered.
- Supervise children when they are near the air purifier.
- **Do not** place anything into any opening on the air purifier, unless directed by the manual.
- **Do not** sit on or place heavy objects on the air purifier.
- Keep the inside of the air purifier dry. To prevent moisture buildup, avoid placing in rooms with major temperature changes or near humidifiers.
- **Always** unplug your air purifier before servicing (such as changing the filter).
- **Do not** use your air purifier if it is damaged or not working correctly, or if the cord or plug is damaged. **Do not** try to repair it yourself. Contact **Customer Support** (see page 18).
- **WARNING:** To reduce the risk of fire or electric shock, **do not** use this air purifier with any solid-state speed controls (such as a dimmer switch).
- Children shall not play with the appliance.
- Children should not clean or perform maintenance on the air purifier without supervision.
- This air purifier is not to be used by persons (including children) with reduced physical, sensory, or mental capacities, or lack of experience and knowledge, unless they have been given supervision or instruction concerning the use of the appliance by a person responsible for the safety.
- Not for commercial use. Household use **only**.

SAFETY INFORMATION (CONT.)

Power & Cord

- Keep air purifier near the outlet it is plugged into.
- **Never** place the cord near any heat source.
- **Do not** cover the cord with a rug, carpet, or other covering. **Do not** place the cord under furniture or appliances.
- Keep the cord out of areas where people walk often. Place the cord where it **will not** be tripped over.
- This appliance has a polarized plug (one blade is wider than the other). To reduce the risk of electric shock, this plug is intended to fit in a polarized outlet **only** one way. If the plug does not fit fully in the outlet, reverse the plug. If it still does not fit, contact a qualified electrician. **Do not** attempt to defeat this safety feature.
- If the power supply cord is damaged, it must be replaced by Arovast Corporation or similarly qualified persons in order to avoid an electric or fire hazard. Please contact **Customer Support** (see page 18).
- This air purifier uses standard US 120V, 60Hz outlets. If using outside of North America, check for compatibility.
- Bending and twisting the wires may cause damage and fire hazard.

Electromagnetic Fields (EMF)

Your Levoit air purifier complies with all standards regarding electromagnetic fields (EMF). If handled properly and according to the instructions in this user manual, the appliance is safe to use based on scientific evidence available today.

GETTING TO KNOW YOUR AIR PURIFIER

- A. Fan Speed Indicators
- B. Fan Speed Button
- C. Sleep Mode Indicator/Button
- D. Timer Button
- E. Timer Indicators
- F. On/Off Button
- G. Display Lock Button
- H. Display Lock Indicator
- I. Check Filter Indicator
- J. Air Outlet
- K. Housing
- L. Air Inlet
- M. Power Cord
- N. Filter Cover
- O. Original Filter

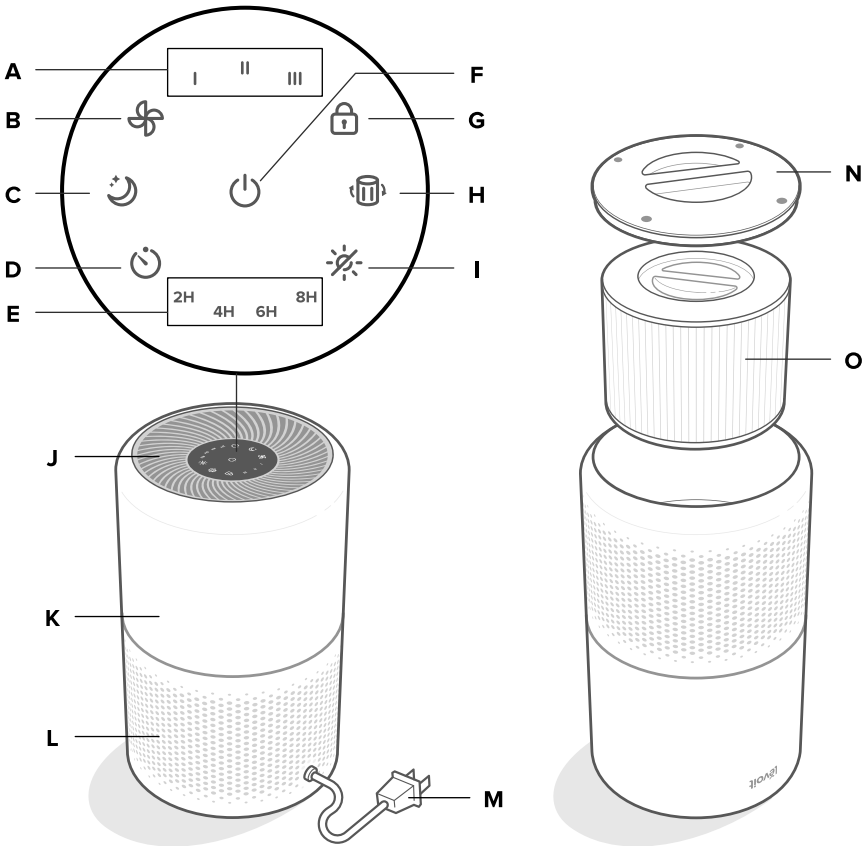

Back

Front, upside down

CONTROLS



On/Off Button

- Turns the air purifier on/off.



Display Lock Button

- Prevents current settings from being changed (see page 9).



Fan Speed Button

- Cycles through fan speeds: I (low), II (medium), and III (high).



Check Filter Indicator

- Lights up when the filter should be checked (see **Check Filter Indicator**, page 11).



Sleep Mode Button

- Turns Sleep Mode on/off (see page 8).



Display Off Button

- Turns the display off.
- Tap any button (except ) to turn the display back on.



Timer Button

- Cycles through timer options (see page 9).

GETTING STARTED

1. Flip the air purifier over. Twist the filter cover counterclockwise and remove it. *[Figure 1.1]*
2. Remove the filter from its plastic packaging and place the filter back into the air purifier with the handle facing up. *[Figure 1.2]*

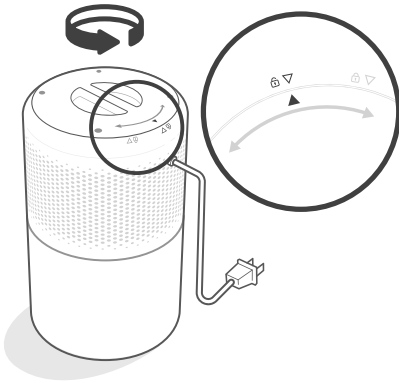

Figure 1.1

3. Replace the filter cover and twist clockwise to lock. *[Figure 1.3]*



Figure 1.3

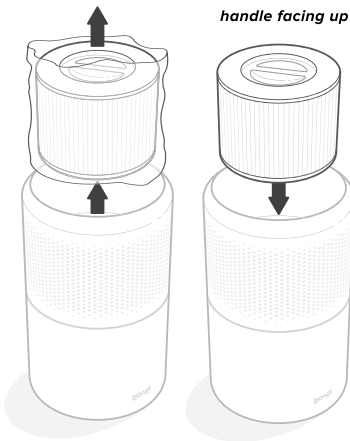



Figure 1.2

USING YOUR AIR PURIFIER

1. Place the air purifier on a flat, stable surface with the display facing up. Allow at least 15 inches / 38 cm of clearance on all sides of the air purifier. Keep away from anything that would block airflow, such as curtains. [Figure 2.1]
2. Plug in and tap  to turn on the air purifier. The fan will start on level I. [Figure 2.2]
3. Optionally, tap  to change fan speed between I, II, and III.

Note:

- The indicators are not buttons and cannot be used to change the fan speed.
- The fan speed indicators will light up when active.
- Fan speed III is the loudest, but cleans air the quickest.
- For best results, or to address a specific air quality issue such as smoke, run the air purifier at high speed (level III) for 15–20 minutes before using a lower speed.
- To effectively clean air, keep windows and doors closed while the air purifier is on.

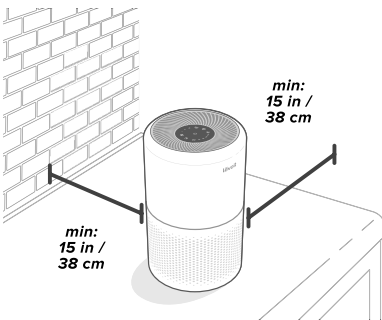



Figure 2.1

4. Tap  to turn off the air purifier.

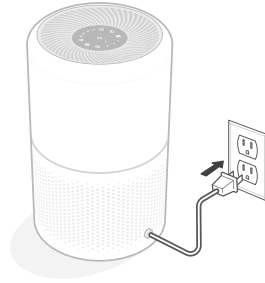

Figure 2.2



Memory Function

When the air purifier is plugged in, it will remember its previous fan speed setting.

Note: The air purifier will not remember timers or Sleep Mode.

Sleep Mode

Sleep Mode operates quietly by using the lowest possible fan speed.

- Tap  to turn Sleep Mode on/off.
- Tapping  will exit Sleep Mode.

Note:

- All indicators will be at half brightness while Sleep Mode is on.

USING YOUR AIR PURIFIER (CONT.)

Timer

You can set a timer for 2, 4, 6, or 8 hours.

1. Tap  repeatedly to select a time. The timer will start automatically.

Note:

- *The indicators are not buttons and cannot be used to select a time.*
- *The timer indicators will light up blue when active.*

2. Once the timer has finished, the air purifier will turn off.
3. To cancel a timer, tap  until all timer indicators are off.

Note:

- *You can change the fan speed at any time while the timer is on.*
- *The timer will restart if the time is changed.*

Display Lock

Locking the display prevents settings from being accidentally changed. Buttons will not respond to being tapped.

1. Tap and hold  for 3 seconds to lock/unlock the display.

Note: *You can turn the display on and off even if the display is locked.*

ABOUT THE FILTER

Humidity

Moisture may damage the filter. This air purifier should be used in an area with a humidity level below 85% RH. If you use the air purifier in excessively humid areas, the surface of the filter will become moldy.

Note: *Water or moisture will allow mold to grow. To solve a mold problem, get rid of the source of the moisture and clean up the mold.*

Essential Oils

Do not add essential oils to the air purifier or filter. The filter will become damaged by the oil and will eventually release an unpleasant smell. **Do not** use oil diffusers near the air purifier.

LEVOIT REPLACEMENT FILTERS

Choose the filter best suited to the environment of your home.

Note: *Your air purifier comes with an Original Filter included.*



Core 300-P-RF



Core 300-P-RF-PA



Core 300-P-RF-TX

CARE & MAINTENANCE

Cleaning the Air Purifier

Note: *Do not clean with abrasive chemicals or flammable cleaning agents.*

1. Unplug before cleaning.
2. Wipe the outside of the air purifier with a soft, dry cloth. If necessary, wipe the housing with a damp cloth, then immediately dry.
3. Vacuum the inside of the air purifier.

Check Filter Indicator

☑ will light up as a reminder to check the filter. Depending on how much you use the air purifier, the indicator should turn on within 6–8 months. You may not need to replace your filter yet, but you should check it when ☑ turns on.

Cleaning the Filter

The outer pre-filter should be cleaned every 2–4 weeks to increase the efficiency and extend the life of your filter. Clean the pre-filter using a soft brush or vacuum hose to remove hair, dust, and large particles.

[Figure 3.1] Do not clean the filter with water or other liquids.

Note: *Do not clean the Main / Activated Carbon Filters.*

Resetting the Check Filter Indicator

Reset the Check Filter Indicator when:

- A. ☑ lights up.
 1. Replace the filter. (see page 12)
 2. Turn on the air purifier.
 3. Press and hold ☑ for 3 seconds.
 4. ☑ will turn off when successfully reset.
- B. The filter was changed before ☑ lit up.
 1. Press and hold ☑ for 3 seconds. This will turn on ☑.
 2. Press and hold ☑ again for 3 seconds.
 3. ☑ will turn off when successfully reset.

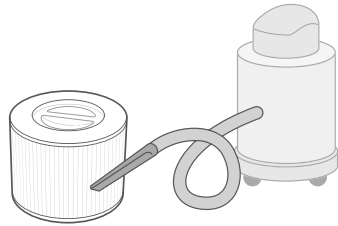



Figure 3.1

CARE & MAINTENANCE (CONT.)

When Should I Replace the Filter?

The filter should be replaced every 6–8 months. You may need to replace your filter earlier or later depending on how often you use your air purifier. Using your air purifier in an environment with relatively high pollution may mean you will need to replace the filter more often, even if  is off.

You may need to replace your filter if you notice:

- Increased noise when the air purifier is on
- Decreased airflow
- Unusual odors
- A visibly clogged filter

Note:

- *To maintain the performance of your air purifier, **only** use official Levoit filters. For more information, contact **Customer Support** (see page 18).*
- *Remember to reset  after changing the filter.*

Replacing the Filter

1. Unplug the air purifier. Flip the air purifier over and remove the filter cover (see **Getting Started**, page 7).
2. Remove the old filter.
3. Clean out any remaining dust or hair inside the purifier using a vacuum hose. **Do not** use water or liquids to clean the purifier. *[Figure 3.2]*
4. Unwrap the new filter and place it into the housing (see **Getting Started**, page 7).
5. Replace the filter cover. The air purifier will not power on unless the cover is replaced correctly.
6. Plug in and turn on the air purifier.
7. Reset the Check Filter Indicator (see page 11).

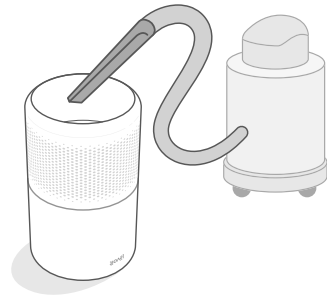



Figure 3.2









Storage

If not using the air purifier for an extended period of time, wrap both the air purifier and the filter in plastic packaging and store in a dry place to avoid moisture damage.

TROUBLESHOOTING

Problem	Possible Solution
<p>Air purifier will not turn on or respond to button controls.</p>	<p>Plug in the air purifier.</p>
	<p>Check to see if the power cord is damaged. If it is, stop using the air purifier and contact Customer Support (see page 18).</p>
	<p>Plug the air purifier into a different outlet.</p>
	<p>The air purifier is malfunctioning. Contact Customer Support (see page 18).</p>
<p>Airflow is significantly reduced.</p>	<p>Make sure the filter is removed from its packaging and properly in place (see page 7).</p>
	<p>Tap  to increase the fan speed.</p>
	<p>Leave 15 inches / 38 cm of clearance on all sides of the air purifier.</p>
	<p>The pre-filter may be clogged by large particles, such as hair or lint, blocking airflow. Clean the pre-filter (see page 11).</p>
	<p>Replace the filter (see page 12).</p>
<p>Air purifier makes an unusual noise while the fan is on.</p>	<p>Make sure the filter is properly in place with plastic packaging removed (see page 7).</p>
	<p>Make sure the air purifier is operating on a hard, flat, even surface.</p>
	<p>Replace the filter (see page 12).</p>
	<p>The air purifier may be damaged, or a foreign object may be inside. Stop using the air purifier and contact Customer Support (see page 18). Do not try to repair the air purifier.</p>
<p>Strange smell coming from the air purifier.</p>	<p>Clean the filter or replace if necessary.</p>
	<p>Contact Customer Support (see page 18).</p>
	<p>Make sure not to use your air purifier in an area with high humidity or while diffusing essential oils.</p>

TROUBLESHOOTING (CONT.)

Problem	Possible Solution
<p>Poor air purification quality.</p>	<p>Tap  to increase the fan speed.</p>
	<p>Make sure no objects are blocking the sides or top of the air purifier (the inlet or outlet).</p>
	<p>Make sure the filter is removed from its packaging and properly in place (see page 7).</p>
	<p>Close doors and windows while using the air purifier.</p>
	<p>If the room is larger than 219 ft² / 20 m², air purification will take longer.</p>
	<p>Replace the filter (see page 12).</p>
<p> is still on after replacing the filter.</p>	<p>Reset the Check Filter Indicator (see page 11).</p>
<p> has not turned on within 8 months.</p>	<p> is a reminder for you to check the filter and will light up based on how much the air purifier has been used (see page 11). If you don't use your air purifier often,  will take longer to turn on.</p>
<p> turned on before 6 months.</p>	<p> is a reminder for you to check the filter and will light up based on how much the air purifier has been used (see page 11). If you run your air purifier frequently,  will turn on sooner.</p>

If your problem is not listed, please contact **Customer Support** (see page 18).

FEDERAL COMMUNICATION COMMISSION INTERFERENCE STATEMENT

This device complies with Part 15 of the FCC Rules. Operation is subject to the following two conditions:

1. This device may not cause harmful interference, and
2. This device must accept any interference received, including interference that may cause undesired operation.

NOTE: This equipment has been tested and found to comply with the limits for a Class B digital device, pursuant to Part 15 of the FCC Rules. These limits are designed to provide reasonable protection against harmful interference in a residential installation. This equipment generates, uses and can radiate radio frequency energy and, if not installed and used in accordance with the instructions, may cause harmful interference to radio communications. However, there is no guarantee that interference will not occur in a particular installation. If this equipment does cause harmful interference to radio or television reception, which can be determined by turning the equipment off and on, the user is encouraged to try to correct the interference by one or more of the following measures:

- Reorient or relocate the receiving antenna.
- Increase the separation between the equipment and receiver.
- Connect the equipment into an outlet on a circuit different from that to which the receiver is connected.
- Consult the dealer or an experienced radio/TV technician for help.

FCC Caution: Any changes or modifications not expressly approved by the party responsible for compliance could void the user's authority to operate this equipment.

FCC SDOC SUPPLIER'S DECLARATION OF CONFORMITY

Arovast Corporation hereby declares that this equipment is in compliance with the FCC rules. The declaration of conformity may be consulted in the support section of our website, accessible from www.levoit.com

WARRANTY INFORMATION

Model	Core 300, Core 300-RAC
<i>For your own reference, we strongly recommend that you record your order ID and date of purchase.</i>	
Order ID	
Date of Purchase	

Levoit Limited Product Warranty

Register your products at <https://warranty.levoit.com/warranty> to stay up to date with important product information such as product updates, limited warranties, usage and maintenance recommendations, and notifications concerning safety warnings or product recalls. Registration is not required to claim your limited warranty.

Two (2) Year Limited Consumer Product Warranty

Arovast Corporation ("Arovast") warrants that the product shall be free from defects in material and workmanship for a period of **2 years from the date of original purchase** ("Limited Warranty Period"), provided the product was used in accordance with its use and care instructions (e.g., in the intended environment and under normal circumstances).

Your Limited Warranty Benefits

During the Limited Warranty Period and subject to this limited Warranty Policy, Arovast will, in its sole and exclusive discretion, either (i) refund the purchase price if the purchase was made directly from the online Levoit store, (ii) repair any defects in material or workmanship, (iii) replace the product with another product of equal or greater value, or (iv) provide store credit in the amount of the purchase price.

Who is Covered?

This limited warranty extends only to the original consumer purchaser of the product and is not transferable to any subsequent owner of the product, regardless of whether the product transferred ownership during the specified term of the limited warranty. The original consumer purchaser must provide verification of the defect or malfunction and proof of the date of purchase to claim the Limited Warranty Benefits.

Be Aware of Unauthorized Dealers or Sellers

This limited warranty does not extend to products purchased from unauthorized dealers or sellers. Arovast's limited warranty only extends to products purchased from authorized dealers or sellers that are subject to Arovast's quality controls and have agreed to follow its quality controls. Please be aware, products purchased from an unauthorized website or dealer may be counterfeit, used, defective, or may not be designed for use in your country.

You can protect yourself and your products by making sure you only purchase from Arovast or its authorized dealers.

If you have any questions about a specific seller, or if you think you may have purchased your product from an unauthorized seller, please contact our Customer Support Team via support@levoit.com.

What's Not Covered?

- Normal wear and tear, including parts that might wear out over time (e.g., batteries, filters, cleaning brush, essential oil pads, etc.).
- If the proof-of-purchase has been altered in any way or is made illegible.
- If the model number, serial number or production date code on the product has been altered, removed or made illegible.
- If the product has been modified from its original condition.
- If the product has not been used in accordance with directions and instructions in the user manual.
- Damages caused by connecting peripherals, additional equipment or accessories other than those recommended in the user manual.
- Damages or defects caused by accident, abuse, misuse, or improper or inadequate maintenance.
- Damages or defects caused by service or repair of the product performed by an unauthorized service provider or by anyone other than Arovast.
- Damages or defects occurring during commercial use, rental use, or any use for which the product is not intended.
- If the unit has been damaged, including but not limited to damage by animals, lightning, abnormal voltage, fire, natural disaster, transportation, dishwasher, or water (unless the user manual expressly states that the product is dishwasher-safe).
- Incidental and consequential damages.
- Damages or defects exceeding the cost of the product.

Claiming Your Limited Warranty Service in 5 Simple Steps:

1. Make sure your product is within the specified limited warranty period.
2. Make sure you have a copy of the invoice and order ID or proof-of-purchase.
3. Make sure you have your product. **DO NOT** dispose of your product before contacting us.
4. Contact our Customer Support Team via support@levoit.com
5. Once our Customer Support Team has approved your request, please return the product with a copy of the invoice and order ID.

Sole and Exclusive Remedy

THE FOREGOING LIMITED WARRANTY CONSTITUTES AROVAST CORPORATION'S EXCLUSIVE LIABILITY, AND YOUR SOLE AND EXCLUSIVE REMEDY, FOR ANY BREACH OF ANY WARRANTY OR OTHER NONCONFORMITY OF THE PRODUCT COVERED BY THIS LIMITED PRODUCT WARRANTY STATEMENT. THIS LIMITED WARRANTY IS EXCLUSIVE, AND IN LIEU OF ALL OTHER WARRANTIES. NO EMPLOYEE OF AROVAST CORPORATION OR ANY OTHER PARTY IS AUTHORIZED TO MAKE ANY WARRANTY IN ADDITION TO THE LIMITED WARRANTY IN THIS LIMITED PRODUCT WARRANTY STATEMENT.

Disclaimer of Limited Warranties

TO THE FULLEST EXTENT PROVIDED BY APPLICABLE LAW, EXCEPT AS WARRANTED IN THIS LIMITED PRODUCT WARRANTY POLICY, AROVAST CORPORATION PROVIDES THE PRODUCTS YOU PURCHASE FROM AROVAST CORPORATION "AS IS" AND AROVAST CORPORATION HEREBY DISCLAIMS ALL WARRANTIES OF ANY KIND, WHETHER EXPRESS OR IMPLIED, STATUTORY, OR OTHERWISE, INCLUDING BUT NOT LIMITED TO ANY WARRANTIES OF MERCHANTABILITY, NON-INFRINGEMENT, AND FITNESS FOR PARTICULAR PURPOSE.

Limitations of Liability

TO THE FULLEST EXTENT PROVIDED BY APPLICABLE LAW, IN NO EVENT WILL AROVAST CORPORATION, ITS AFFILIATES, OR THEIR LICENSORS, SERVICE PROVIDERS, EMPLOYEES, AGENTS, OFFICERS, OR DIRECTORS BE LIABLE FOR:

- (a) DAMAGES OF ANY KIND ARISING OUT OF OR IN CONNECTION WITH PRODUCTS PURCHASED FROM AROVAST CORPORATION IN EXCESS OF THE PURCHASE PRICE PAID BY THE PURCHASER FOR SUCH PRODUCTS, OR
- (b) INDIRECT, SPECIAL, INCIDENTAL, CONSEQUENTIAL, OR PUNITIVE DAMAGES EVEN IF AROVAST CORPORATION OR ONE OF ITS SUPPLIERS HAS BEEN ADVISED OF THE POSSIBILITY OR LIKELIHOOD OF SUCH DAMAGES.

AND REGARDLESS OF WHETHER CAUSED BY TORT (INCLUDING NEGLIGENCE), BREACH OF CONTRACT, OR OTHERWISE, OUR LIABILITY SHALL UNDER NO CIRCUMSTANCES EXCEED THE ACTUAL AMOUNT PAID BY YOU FOR THE DEFECTIVE PRODUCT, NOR SHALL WE UNDER ANY CIRCUMSTANCES BE LIABLE FOR ANY CONSEQUENTIAL, INCIDENTAL, SPECIAL OR PUNITIVE DAMAGES OR LOSSES, WHETHER DIRECT OR INDIRECT.

EXCEPT AS COVERED BY THIS LIMITED PRODUCT WARRANTY STATEMENT, AROVAST CORPORATION SHALL NOT BE LIABLE FOR COSTS ASSOCIATED WITH THE REPLACEMENT OR REPAIR OF PRODUCTS PURCHASED FROM IT, INCLUDING, BUT NOT LIMITED TO, LABOR, INSTALLATION, OR OTHER COSTS INCURRED BY THE USER AND, IN PARTICULAR, ANY COSTS RELATING TO THE REMOVAL OR REPLACEMENT OF ANY PRODUCT.

OTHER RIGHTS YOU MAY HAVE

SOME JURISDICTIONS DO NOT ALLOW FOR: (1) EXCLUSION OF IMPLIED WARRANTIES; (2) LIMITATION ON THE DURATION OF IMPLIED WARRANTIES; AND/OR (3) EXCLUSION OR LIMITATION OF INCIDENTAL OR CONSEQUENTIAL DAMAGES; SO THE DISCLAIMERS IN THIS POLICY MAY NOT APPLY TO YOU. IN THESE JURISDICTIONS YOU HAVE ONLY THE IMPLIED WARRANTIES THAT ARE EXPRESSLY REQUIRED TO BE PROVIDED IN ACCORDANCE WITH APPLICABLE LAW. THE LIMITATIONS OF WARRANTIES, LIABILITY, AND REMEDIES APPLY TO THE MAXIMUM EXTENT PERMITTED BY LAW.

ALTHOUGH THIS LIMITED WARRANTY GIVES YOU SPECIFIC LEGAL RIGHTS, YOU MAY HAVE OTHER RIGHTS IN YOUR JURISDICTION. THIS STATEMENT OF LIMITED WARRANTY IS SUBJECT TO APPLICABLE LAWS THAT APPLY TO YOU AND THE PRODUCT. PLEASE REVIEW THE LAWS IN YOUR JURISDICTION TO UNDERSTAND YOUR RIGHTS FULLY.

CHANGES TO THIS POLICY

We may change the terms and availability of this limited warranty at our discretion, but any changes will not be retroactive.

This warranty is made by:

AROVAST CORPORATION
1202 N. Miller St., Suite A
Anaheim, CA 92806, USA

CUSTOMER SUPPORT

If you have any questions or concerns about your new product, please contact our helpful Customer Support Team.

Arovast Corporation

1202 N. Miller St., Suite A
Anaheim, CA 92806, USA

Email: support@levoit.com

Toll-Free: 1-888-726-8520

Support Hours

Mon–Fri, 9:00 am–5:00 pm PST/PDT

*Please have your order invoice and order ID ready before contacting Customer Support.



The energy efficiency of this ENERGY STAR certified model is measured based on a ratio between the model's CADR for Smoke and the electrical energy it consumes, or CADR/Watt.

lėvoit[®]