

AIR PURIFIER EUROPA USER MANUAL

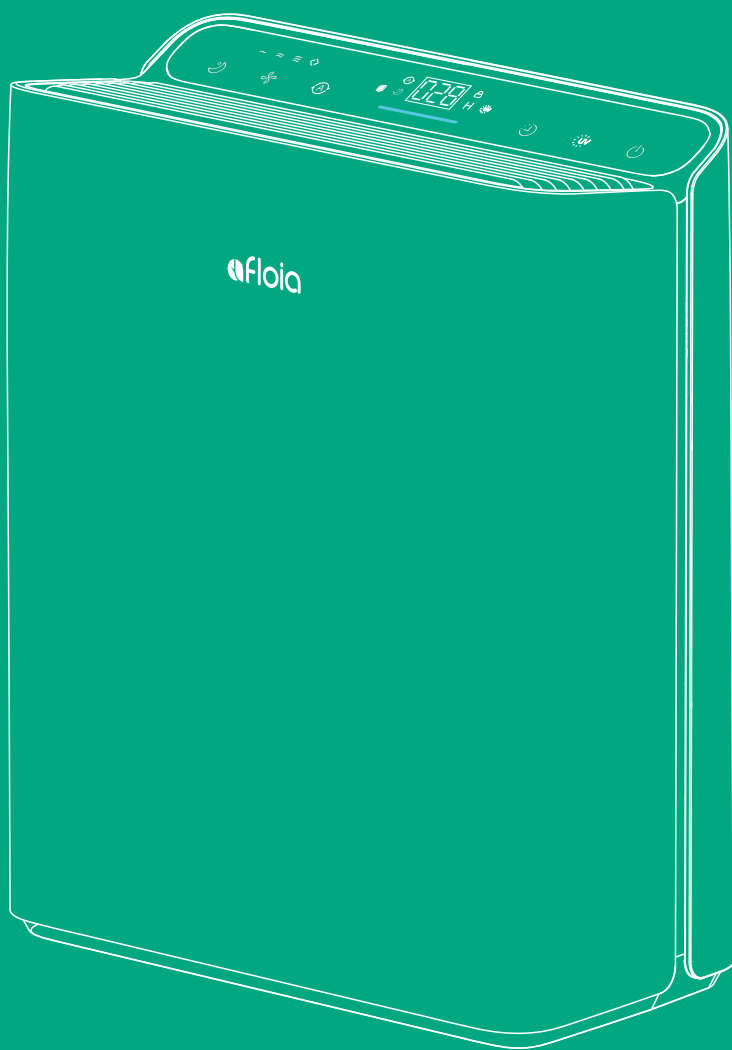

Thank you very much for using our products.
Please read the user manual carefully before use, and keep it for future reference.

STOP

**PLEASE DO NOT RETURN
THIS PRODUCT TO RETAILER**

If you are missing parts, having ANY
questions or problems when using this
product, please contact:

✉ Email : service@afloia.com



Facebook messenger

24/7 LIVE CHAT SUPPORT

CONTENTS

Before Use ● TOP FEATURES OF AFLOIA AIR PURIFIER	2
CONTROLS AND DISPLAY	3-4
During Use ● GET STARTED	5
WARM TIPS	6
USING YOUR EUROPA AIR PURIFIER	7-8
ABOUT FILTER	9-11
CAUTION / ATTENTION	12-14
Before Asking for Support ● TROUBLESHOOTING	15-16
Service Information ● PRODUCT SPECIFICATIONS	17

Dear customers,
Thank you for purchasing Afloia Air Purifier.

Please keep this User Manual for your reference.
This manual will guide you if you have any questions or troubleshooting problems.

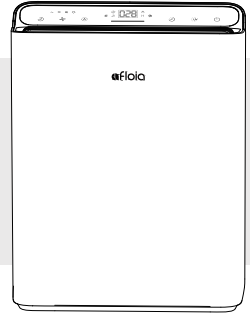

TOP FEATURES of Afloia AIR PURIFIER

- **Air Quality Monitoring**
The air purifier display shows real-time air quality, and the light bar below will change color based on the air quality.
- **Auto Mode**
In auto mode, the air purifier will automatically adjust the fan speed based on real-time air quality to maintain a good level of air quality.
- **Air Purification**
The air purifier has a 3-stage filtration system (pre-filter, high-efficient filter, activated carbon filter). Improved filter with larger expansion area and longer length than others.
- **Timer Setting**
You can set the timer from 2 to 24 hours depending on preference.
- **Adjustable Fan Speed & Sleep Mode**
You could choose from 4 fan speeds: low/medium/high/turbo. One-click to switch on Sleep Mode, the air purifier will run more quietly and the panel will light off.
- **Child Lock**
In child lock mode, the panel will be locked (all buttons become inactive), preventing children from accidentally touching it.
- **Filter Replacement Indicator**
The built-in filter replacement indicator reminds users when the filter needs to be replaced.

Please read the instructions carefully before using the product and keep them properly.

CONTROLS AND DISPLAY

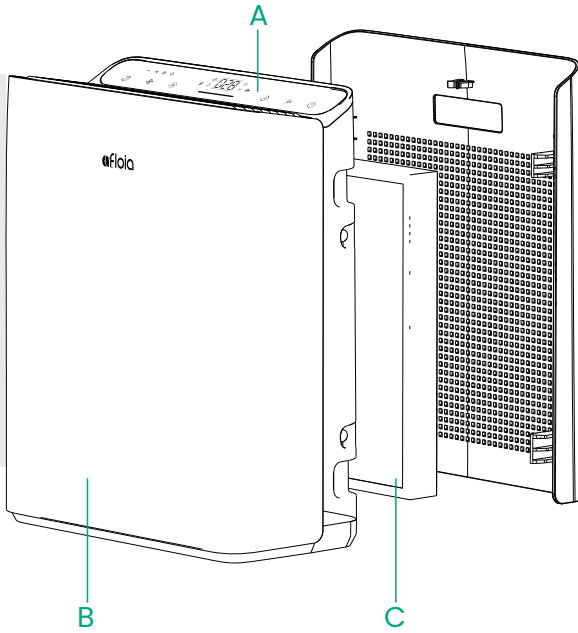

Front

- A** Display
- B** Front Cover
- C** 3-Stage Filter

Back

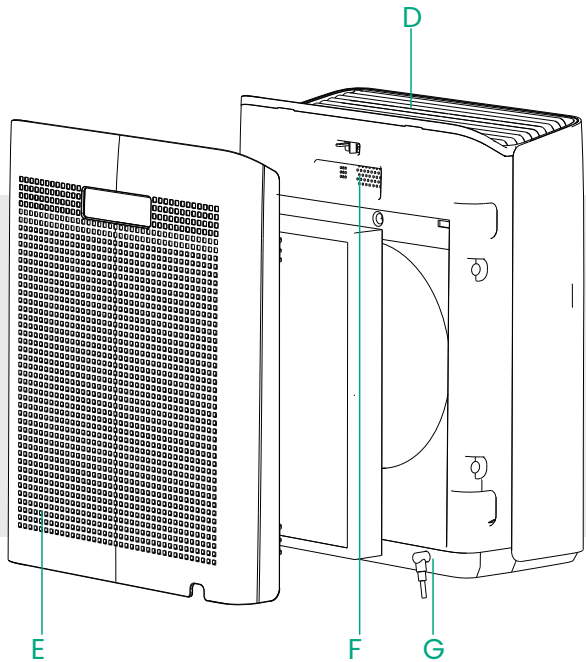

- D** Air Outlet
- E** Back Cover (Air Inlet)
- F** Air Quality Sensor
- G** Power Cord Input

CONTROLS AND DISPLAY

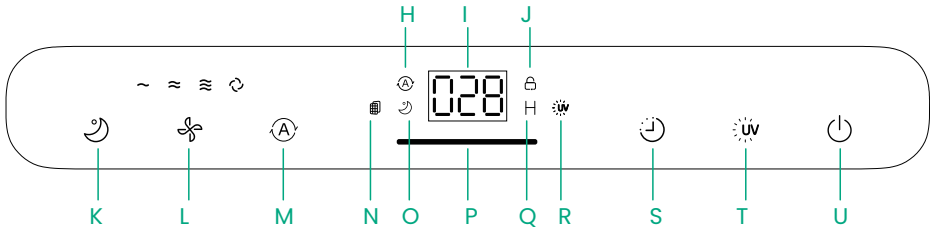

H Auto Mode Indicator

I Air Quality Display

J Child Lock Indicator

K Sleep Mode Button

L Fan Speed Button

M Auto Mode Button

N Filter Replacement Indicator

O Sleep Mode Indicator

P Air Quality Indicator

Q Timer Indicator

R UV Light Indicator

S Timer Button

T UV Light Button

U On/Off Button

GET STARTED

Package Contents

- 1 x Europa air purifier
- 1 x User manual
- 1 x High-efficient filter (pre-installed)
- 1 x Power cord (placed at the bottom of the air purifier)

Unboxing

Take the user manual, and Europa air purifier out of the box. Remove the packaging materials surrounding them. Please keep the product box in a safe location for future use.

1. Take out the power cord from the bottom of the air purifier.
2. Place the air purifier on a stable surface. Pull both sides of the back cover to remove it.
3. Take out the filter and remove its plastic packaging.
4. Reinstall the filter.
5. Close the back cover. Note: align the bottom slots first.
6. Insert the power cord into the back of the air purifier.

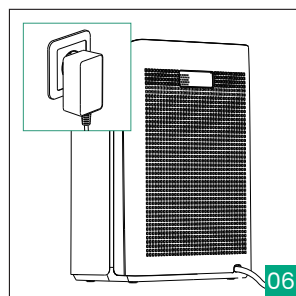
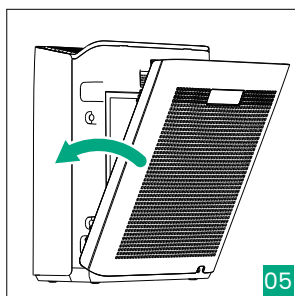
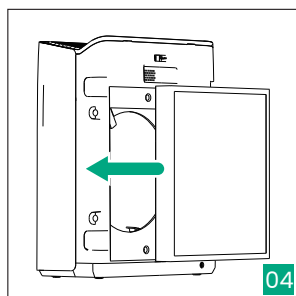
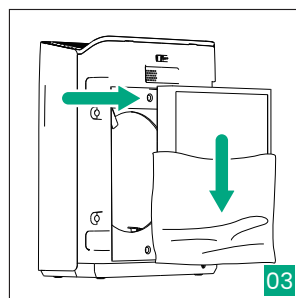
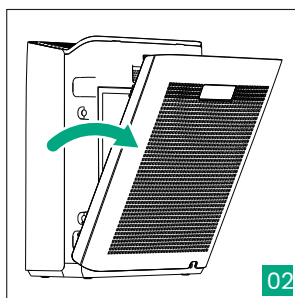
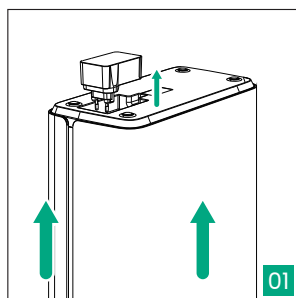

Connect the Power

• Please confirm that the input voltage is 100-240V 50/60Hz, and ensure that the power plug and your hands are dry before you insert the power cord into the outlet.

Note: Contact Customer Service when the power cord is damaged or broken. To replace the damaged power cord, please visit Aflora website and contact service@aflora.com.

- Keep the air purifier away from water and wet or damp areas.
- Do not use in excessively humid areas.
- Keep the air purifier away from heat sources.
- Do not use where combustible gases, vapors, metallic dust, aerosol (spray) products, or fumes from industrial oil are present.

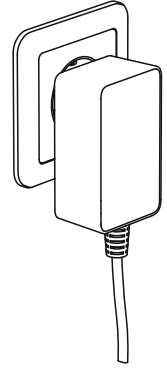

Maximum Purification Efficiency

- To achieve good performance, allow at least 1ft/30cm clearance from the air quality sensor and the back cover of the air purifier.
- Make sure no obstacles in front of the air inlet or on the air outlet.
- To effectively clean air, keep windows and doors closed while the air purifier is on.

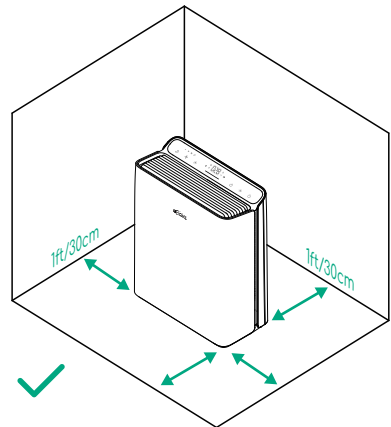
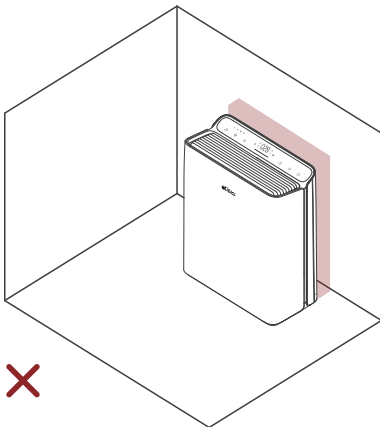

USING YOUR EUROPA AIR PURIFIER

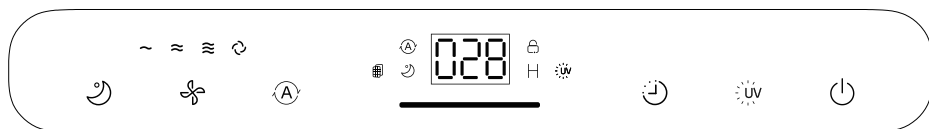

Air Quality Display & Air Quality Indicator

- Inbuilt with a laser air quality sensor, Europa Air Purifier detects particulate matter as small as 2.5 microns (PM 2.5) in the air and determines the concentration of particulates in indoor spaces.
- The display shows exact PM 2.5 value, the light indicator below it shows real-time air quality in different colors: Blue (Very Good), Green (Good), Orange (Moderate), Red (Bad).



Sleep Mode Button

With Sleep Mode, you will not be disturbed by fan sound and display light while at sleep.

- Tap Sleep Mode Button to turn on sleep mode.
- The display turns off after 5 seconds except for the On/Off Button and Sleep Mode Indicator.
- You can turn the display back on by tapping On/Off Button.
- Tap Fan Speed Button or Auto Mode Button to exit sleep mode.



Fan Speed Button & Indicators

Cycles through fan speeds:







Auto Mode Button & Indicator

- Tap Auto Mode Button to turn the auto mode on. The Auto Mode Indicator lights up when Auto Mode is on.
- In Auto Mode, Europa Air Purifier will adjust the fan speed according to the real-time air quality.
- To switch from Auto Mode, tap the Auto Mode Button again or tap Fan Speed/Sleep Mode Button.

Air Quality Indicator Chart

PM 2.5 Value (ug/m ³)	Light Color	Air Quality	Fan Speed
PM2.5<=50	Blue	Very Good	Low
50<PM2.5<=100	Green	Good	Medium
100<PM2.5<=150	Orange	Moderate	High
PM2.5>150	Red	Bad	Turbo

USING YOUR EUROPA AIR PURIFIER

	Timer Button & Indicator <ul style="list-style-type: none">• The Timer Indicator is on when you set a timer.• Cycles through Timers: 2H-4H-8H-16H-24H-Cancel.• Select a time - Time value flashes 5S - Back to display PM2.5 value - Timer setting completed.
	UV Light Button & Indicator <ul style="list-style-type: none">• Tap UV Light Button to turn the UV light on/off.• The inbuilt ultraviolet light shines through the air inside the machine and kill bacteria in it, to achieve a better air purification effect.• In UV Light Mode, the UV light will work on and off every 2 hours. But the UV Light Indicator keeps on.
	On/Off Button <ul style="list-style-type: none">• Tap On/Off Button to turn the air purifier on or off.• Memory function: When the machine is turned off and reopened, the settings remain the same as before (but the timer defaults to off).
	Filter Replacement Indicator <ul style="list-style-type: none">• If Filter Replacement indicator blinks, check if the filter needs to be replaced or cleaned.• After replacing with a new filter, press and hold On/Off Button for 7 seconds to make a filter life reset.
	Child Lock Indicator <ul style="list-style-type: none">• Press and hold the UV Light Button for 3 seconds to turn on/off Child Lock.

ABOUT FILTER

3-Stage Filtration System

Stage 1

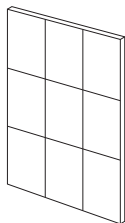

Stage 2

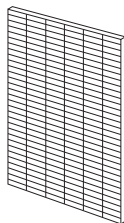

Stage 3

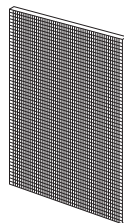

ABOUT FILTER

ABOUT FILTER	
Stage 1	Pre Filter
Stage 2	High-Efficient Filter
Stage 3	Activated Carbon Filter

※ The picture may differ from the actual product.

How to Replace Filter

The Filter Replacement indicator will blink after 2200 hours use to remind you of checking the filter. You need to replace with a new filter or clean the filter at least, and then reset the Filter Replacement Indicator.

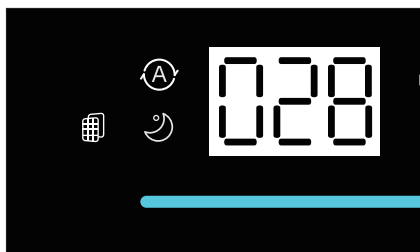

1. The Filter Replacement indicator blinks.

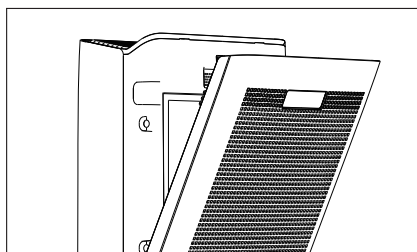

2. Unplug the air purifier, pull both sides of the back cover to remove it.

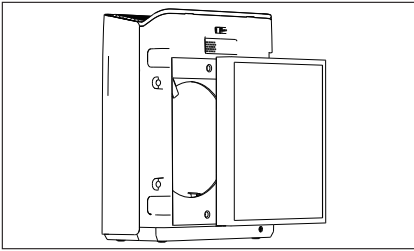

3. Take out the old filter. Clean the filter placement with dry soft cloth if needed.

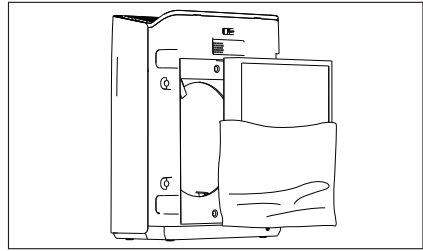

4. Remove the packaging of the new filter.

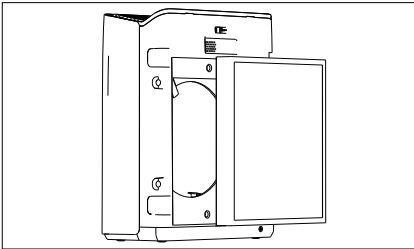

5. Install the new filter

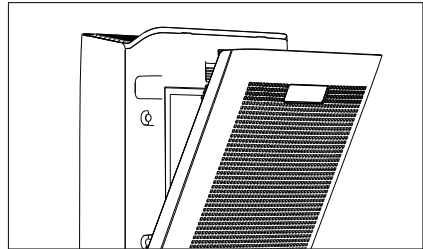

6. Close the back cover.

Note: align the bottom slots first.



7. Plug and Restart the machine, the indicator still blinks at this time. **Press and hold the On/Off Button for 7 seconds until the indicator lights off.**

* Note:

- If the filter was changed before the indicator blinks, please press and hold Fan Speed Button and Timer Button for 3 seconds to make a manual reset. Otherwise, the life circle of the old filter is not finished.
- You can clean the pre filter with soft cloth. Do not wash the filter.

ABOUT FILTER



To maintain good performance of your air purifier, only use Afloia official filters. To buy more official filter replacements, please search **B0CD7CTJF5** on Amazon or scan the QR code.

Maintenance

- Ensure the product is unplugged before maintenance.
- Do not immerse the air purifier into water or any liquid.
- Do not use abrasive, corrosive or flammable cleansers (such as bleach or alcohol) to clean any part of the unit.
- Do not wash the filter.

Cleaning & Storage

- Ensure the air purifier is powered-off and unplugged.
- Use a soft cloth to clean dusts or debris on the surface of the air purifier, air inlet, air outlet and pre filter.
- Place the air purifier in the original box or other suitable places for storage.
- If you do not use it for a long time, please turn on the air purifier for a few minutes from time to time to ensure a good performance.

* Please comply with the 'Caution' as they are provided to ensure safe and proper use of the product and prevent accidents and dangerous situations.

Safety Instructions



Introduction

Thank you for choosing a device from Afloia.

Intended use

- The device is used exclusively for cleaning the ambient air indoors.
 - Please read these operating instructions before using the machine and please follow the safety instructions.
- The operating instructions must be kept available at all times.



Safety instructions

- Keep packing material, such as plastic wrapping, away from children!
(Risk of suffocation)
 - Please follow the safety instructions to prevent fire or electric shock. Only use the device indoors.
 - Only use a socket that supplies the correct voltage (see rating plate).
 - Do not modify or repair the device.
 - Do not use the device if the power cable or mains plug is damaged or if the connection at the socket is not stable.
 - Make sure that the power cable does not get crushed while you are using the device and that it cannot be damaged in any other way. Place the cable so that no one will trip over it.
- Do not pull the power cable tight.
- Disconnect the plug from the socket for cleaning purposes and whenever the device is not in use for a significant period of time.
 - Do not touch the plug or the device if you have wet hands.
 - Do not spray any insect repellent.
 - Do not use in rooms where the device may come into contact with fuel vapour, oil vapour or metal dust.
 - Do not use any volatile liquids, petroleum, kerosene, paint thinner or polishing paste to clean the device. Such liquids may damage the surface of the device.
 - Do not expose the device to rain, water, moisture or high humidity, and do not set it up in a bathroom or kitchen next to a sink.
 - Make sure that no foreign objects get into the outlet grilles.
 - Do not use near a naked flame or sparks.
 - The device is not suitable for removing harmful gases (carbon monoxide, e.g. from heating appliances).
 - Unless they are supervised, the device must not be used by those (including children) with reduced, physical, sensory and mental abilities or who do not have the required experience and knowledge.

CAUTION

Safety Instructions



Safety instructions

- Do not block the air intake or outlet.
 - Do not expose the air purifier to direct sunlight, a naked flame or heat.
 - Only use the air purifier in living quarters and within the specified technical parameters. Improper usage may pose a threat to life and health.
 - Do not use the device near a smoke detector. Air blowing towards a smoke detector could delay the alarm or not trigger at all.
-



Caution

- Risk of injury due to electric shock.
Always disconnect the mains plug prior to :
- Maintenance and cleaning
 - Moving the device
 - Changing the filter
-



Caution

- Do not use any spray cans with flammable contents near to the air purifier!
-



Caution

- Do not use any flammable cleaning agents

Cleaning The Air Quality Sensor

It is recommended to clean the Air Quality Sensor every 1-2 months to help maintain the sensitivity of the sensor. If the Air Quality Indicator shows red (indicating Bad air quality) more than usual, you may need to check if the Air Quality Sensor needs to be cleaned.

Note:

How often you clean the Air Quality Sensor depends on the air quality of your environment.

1. Unplug the air purifier.

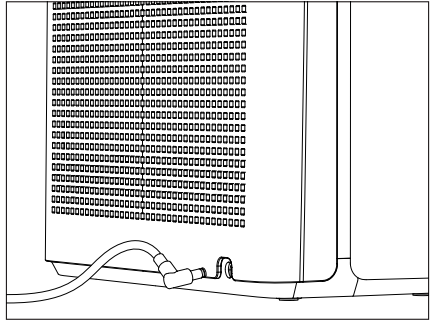

2. Use a soft wet cloth to wipe up dusts around the sensor.

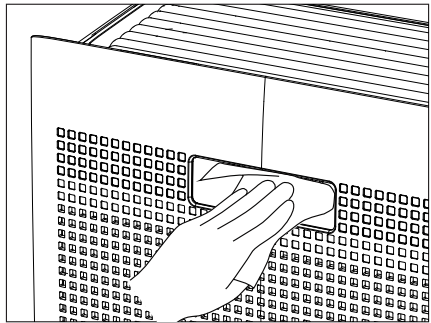

3. Plug the air purifier after drying.

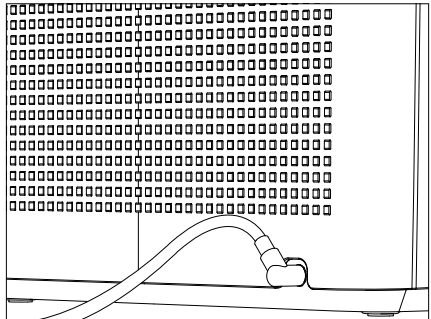

TROUBLESHOOTING

Problem	Possible Solutions
The air purifier won't work even if I press On/Off button.	Plug in the air purifier.
	Check if the power cord is damaged, if yes, contact Customer Service: service@afloia.com
	Try other power outlets.
	The air purifier is malfunctioning. Unplug the air purifier and contact Customer Service.
No air is blowing out.	Remove any obstacles from the air inlet.
	Check if plastic packaging has been removed from filter.
	Check if the fan works, if not, unplug the purifier and contact Customer Service.
The air purifier makes unusual noises.	Remove the plastic bag of the filter and install it properly.
	Place the air purifier on a flat and stable surface.
	Clean or replace the filter.
	The air purifier is malfunctioning. Unplug the air purifier and contact Customer Service.
Air Quality Indicator stays blue even when air quality is poor.	Clean Air Quality Sensor (above the air inlet).
	Make sure it is not gases that makes poor air quality. The Air Quality Sensor detects PM 2.5, it will not detects gases.
	Keep the air inlet at least 30cm away from around.
Air Quality Indicator always stays red.	Clean Air Quality Sensor (please see P14).
	Do not use humidifiers at the same time. That might affect the accuracy of Air Quality Sensor.
	Keep the air inlet at least 30cm away from around.

Problem	Possible Solutions
The air purifier gives out strange smell.	Clean the filter, or replace it if needed.
	Do not use the air purifier in areas with high humidity or while cooking or using essential oil diffusers.
	Unplug the air purifier and contact Customer Service.
The air purifier does not purify the area well.	Change to a higher fan speed.
	Keep the air inlet at least 30cm away from around. Make sure nothing in front of the air inlet or on the air outlet.
	Keep windows and doors closed while the air purifier is on.
	Make sure the filter without packaging.
	Clean the filter, or replace it if needed.
The air purifier turns off randomly.	It will take a longer time to purify if the area is larger than suggested.
	The air purifier is malfunctioning. Unplug the air purifier and contact Customer Service.
Replaced the filter but Filter Replacement Indicator still blinks.	Restart the machine, press and hold On/Off Button until the indicator stops blinking.
	If reset failed, contact Customer Service.
All buttons and indicators blinks and do not respond to operation.	Check if the child lock is on, if yes, press and hold the UV Light Button for 3 seconds to turn off.
	The air purifier is malfunctioning. Unplug the air purifier and contact Customer Service.

PRODUCT SPECIFICATIONS

Category	Air Purifier
Model	Europa
Power Supply	Input: 100-240V 50/60Hz Output: 24V $\overline{=}$ 1.5A
Rated Power Input	32W
CADR(Clean Air Delivery Rate)*	280m ³ /h
Dust Collecting Method	Mechanical dust collecting method
Product Size	D12.4 x W6.2 x H15.6 inch / D316 x W158 x H398 mm
Product Weight	8.15 lbs / 3.7kg
Place for Use	For indoors

1.The information (exterior, design, and specifications) provided in this User Manual is subject to change without prior notice to improve the quality of the device.

2.Room coverage** based on the Air Change Per Hour or ACPH which is how many times per hour the air in your room will be fully purified.

Inquiry about Malfunction

Product parts may wear out due to heat, moisture, dust and other causes over time, which may cause malfunction of the product.

In the case that

- ① Something other than the symptoms coming under "Troubleshooting".
- ② You can feel electricity when you touch the product with your hands.
- ③ The power is supplied, but the fan does not work.
- ④ Other malfunctions occur.



Please stop using the product.

Please unplug the product and contact service@afoia.com

Warranty

For questions about our warranty or to look at our other products, please visit our website: www.afoia.com



AIR PURIFIER EUROPA USER MANUAL

We provide satisfying consultation and services concerning your complaints, suggestions, and recommendations upon receiving your troubled product model name, status, and contact information.

- After reading this manual, keep it in a place easily accessible to the user for future reference.
- Caution : Please read this manual carefully to ensure safety and a longer product lifespan.

www.afloia.com

service@afloia.com

Europa USA-SMS-20230802-V01