

Your excellent helper in
measuring instruments.

NF-826

UNDERGROUND WIRE LOCATOR USER MANUAL



Your excellent helper in measuring instruments.



VER: V1

CONTENTS

1. Overview	01
1.1 Product introduction.....	02
1.2 Characteristics of NF-826 Cable Locator	03
1.3 Names and functions of parts.....	04
1.3.1 Sketch of transmitter	04
1.3.2 Transmitter display	04
1.3.3 Sketch of receiver.....	05
1.3.4 Receiver display	05
1.3.5 Display of receiver under cable locating mode.....	05
2. Carrying out measurement	06
2.1 Measurement precautions.....	06
2.2 Functional principle.....	06
2.3 Examples of typical application.....	08
3. Details of application	09
3.1 In open circuit	09
3.1.1 Locating of line interruptions	10
3.1.2 Locating and tracing of lines and sockets.....	11
3.1.3 Detect the narrow (blocked) part of the laid non-metallic pipeline.....	12
3.1.4 Detect the laid metal tap water pipe and metal heating pipe	13
3.1.5 Locating of line interruptions using two transmitters	13
3.1.6 Error detection for an electrical floor heating	15
3.1.7 Track an underground circuit.....	16
3.1.8 Detect the power supply circuit on the same floor.....	17
3.2 Dual-pole applications.....	18
3.2.1 Search for the fuses.....	18
3.2.2 Search for short circuit in the circuit.....	19
3.2.3 Applications in closed circuits.....	20
3.2.4 Classify or determine the laid circuit	21
3.2.5 Detect circuits laid relatively deep.....	22
3.3 Method to increase the effective radius of detecting charged circuits	23
3.4 Identify voltage in the grid and search for breakages in the circuit.....	24

4. Other functions	25
4.1 Voltmeter function of the transmitter.....	25
4.2 Flashlight function	25
4.3 Backlight function	25
4.4 Mute function.....	25
4.5 Automatic shutdown function	25
5. Technical parameters	26
6. Repair and maintenance	27
6.1 Troubleshooting	27
6.2 Checking of the fuse of the transmitter.....	28
6.3 Cleaning	28
7. Accessories	28

1. OVERVIEW

1. The working temperature of this Cable Locator is 0-40°C (32-104°F).
2. To avoid damage, this device should be protected against excessive mechanical vibration during handling or use, especially dropping.
3. Only professionals are allowed to calibrate and repair this instrument.
4. Prior to usage, inspect the instrument and the test lead in use for external damage. Please ensure that the instrument and the test lead in use are intact. The instrument should not be used unless all the functions of the instrument are well prepared for work.
5. When using the instrument, the rated voltage of the tested line should not exceed the rated voltage specified in the technical specifications of this Cable Locator.
6. Keep the instrument off direct sunlight to ensure perfect functioning and long service life.
7. If the instrument is subject to an extremely high electromagnetic field, its functioning ability may be impaired.
8. Only use batteries as described in the technical data section.
 - 1) Before using a locator that has been placed or transported under extreme climate conditions, please place it under a new favorable environment for a certain period.
 - 2) When the transmitter is connected with live mains, if the Grounding hole of the transmitter is connected with protective ground phase, the current leakage (if any) in the power supply line may join the circuit current of the transmitter, leading to tripping of the leakage circuit breaker, i.e. tripping of FI/RCD.
 - 3) Please maintain the original package well for later mailing (such as for calibration of the instrument).

1.1 Product introduction

When you are making a hole in the wall for installation of an air conditioner or on the floor for installation of a machine, or excavating a road, you have to know the layout of the cables, water pipelines or gas pipelines in the wall or ground to keep away from these facilities and avoid unnecessary troubles and even dangers. In the past, there is only one solution for this issue, that is, to find the construction drawings of these embedded facilities. However, in most cases, these drawings cannot be found and you have to take your chance, which may result in interruption of cables or pipelines, bringing about the danger of power failure, electric shock, explosion or threat to life.

Now, with this NF-826 Cable Locator developed by our company to effectively assist users to locate and detect cables, you no longer need to take your chance.

This Cable Locator is a portable instrument consisting of a transmitter, a receiver and some accessories. With advanced integrated parts and digital circuit technologies, it is characterized by highly stable and reliable electrical performance. The transmitter sends to the target cable (or metal pipes) an AC voltage modulated by digital signals, which generates an alternating electric field; Put the sensor head of the receiver close to this electric field, and the sensor will generate induced voltage. This instrument can magnify this weak voltage signal by hundreds of times and then display it via an LCD screen after audio frequency decoding, demodulation and digital processing, so that the position of the buried cables or pipes, as well as their faults, can be detected based on the change of the signal.

This Cable Locator is user friendly and provides convenient operation by means of keystroke, which can indicate effective pressing through a buzzer. Besides, the display is visualized and the transmitter and receiver are equipped with LED lamps. The transmitter not only transmits signals but also acts as an AC/DC voltmeter, so that the instrument can display the voltage of the tested line, including the AC/DC status, in addition to a warning symbol when testing a live line. Besides, the transmitter is also provided with self-inspection function, which is realized by showing in the display whether the transmitter is transmitting signals, making the users more confident in testing. The display of the receiver has backlights, so that users can see the testing results even in darkness. To improve the testing efficiency, the receiver is equipped with a loudspeaker, which will give changing tones at the time of changed signal intensity, so that users can judge the testing effects simply by sound, leading to enhanced convenience. In order to adapt the instrument to a noisy environment, loud sound is used by the loudspeaker. Of course, mute mode for both the transmitter and the receiver is provided to prevent them from disturbing others when the instrument is used.

This Cable Locator is applicable for construction involving telecommunication cables, power cables and building pipelines, as well as maintenance of such cables and pipelines.

1.2 Characteristics of Cable Locator NF-826

- ◆ Detecting cables, electrical lines, water/gas supply pipelines buried in wall or earth;
- ◆ Detecting interruptions and short circuit in cables and electrical lines buried in wall or earth;
- ◆ Detecting fuses and assigning current circuits;
- ◆ Tracing sockets and distribution sockets having accidentally been covered by plastering;
- ◆ Detecting interruptions and short-circuits in floor heating;
- ◆ The transmitter is integrated with the function of AC/DC voltmeter, which can measure 12 to 400V AC/DC voltage on a linear basis:
AC: 12 ~ 400V (50 to 60 Hz) \pm 2.5%
DC: 12 ~ 400V \pm 2.5%
- ◆ The screen of the transmitter can display preset transmitting power, transmitted codes, its own battery energy, mains voltage detected, AC/DC status of mains voltage detected, and warning symbol for mains voltage.
- ◆ The transmitter has the function of self-inspection to detect its own working status and to display it on the LCD screen for user's reference.
- ◆ The screen of the receiver can display the transmitting power of the transmitter, transmitted codes, energy of the transmitter's and its own batteries, AC voltage induced signal detected and warning symbol for mains voltage.
- ◆ The sensitivity of the receiver can be adjusted either manually or automatically.
- ◆ The receiver can sweep frequency automatically.
- ◆ Both the transmitter and the receiver can work under mute mode.
- ◆ The receiver is available with automatic shutdown (It is powered off automatically over 15 minutes of absence of keystroke).
- ◆ The receiver's LCD screen is provided with backlight for application in poor light.
- ◆ Both the transmitter and the receiver is provided with flash light function when working in darkness.
- ◆ Additional transmitters are available to extend or distinguish several signals.
- ◆ Compactness, durability and portability.

1.3 Names and Functions of Parts

◆ 1.3.1 Sketch of transmitter

- ① LCD screen.
- ② Power on/off key.
- ③ Up key. When setting power level or code, press it to go up.
- ④ Down key. When setting power level or code, press it to go down.
- ⑤ Key for turning on/off flashlight.
- ⑥ Key for setting/confirming code information to be transmitted. Press this key for 1 second to enter code setting and press it briefly to exit setting
- ⑦ Key for setting/confirming transmitting power level (Level I, II or III)
- ⑧ Key for Mute or Backlight
- ⑨ Key for transmitting or stopping to transmit code information.
- ⑩ Grounding hole. The transmitter is grounded with the test lead through this hole.
- ⑪ "+" hole, input/output hole of the transmitter. The transmitter is connected to external cables with the test lead through this hole to send out signals and receive detected voltage signals.



◆ 1.3.2 Transmitter display

- ① Symbol to indicate mains voltage.
- ② Transmitting code.
- ③ Mains DC voltage
- ④ Mains AC voltage
- ⑤ Mains voltage value (can be used as an ordinary voltmeter; range: 12~400v DC/AC)
- ⑥ Code being transmitted.
- ⑦ Intensity of signal being transmitted.
- ⑧ Transmitting power level.
- ⑨ Symbol to indicate mute mode.
- ⑩ Transmitting status.

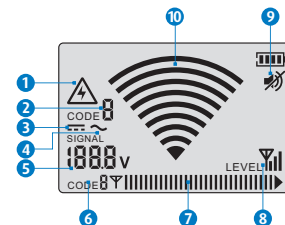

◆ 1.3.3 Sketch of receiver

- ① Flashlight.
- ② Probehead
- ③ LCD screen
- ④ Power on-off key
- ⑤ Key for adjusting sensitivity up under manual mode.
- ⑥ Key for adjusting sensitivity down under manual mode.
- ⑦ Key for turning on/off the flashlight.
- ⑧ NCV
- ⑨ MANUAL key for switchover between manual and automatic cable locating.
- ⑩ Mute
- ⑪ Backlight



◆ 1.3.4 Receiver display

- ① Symbol to indicate voltage/energy of the receiver's battery.
- ② Symbol to indicate mains voltage.
- ③ Singal value when detecting cable.
- ④ Code received.
- ⑤ Intensity of signals when detecting cable or AC detecting.
- ⑥ Signal inrtensity level received.
- ⑦ Symbol to indicate mute mode.
- ⑧ Received sensitivity under Manual mode.
- ⑨ Manual mode
- ⑩ Automatic mode
- ⑪ NCV

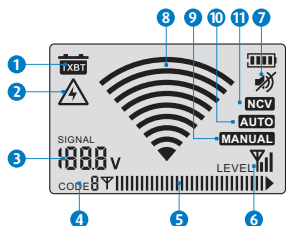

◆ 1.3.5 Display of receiver under cable locating mode

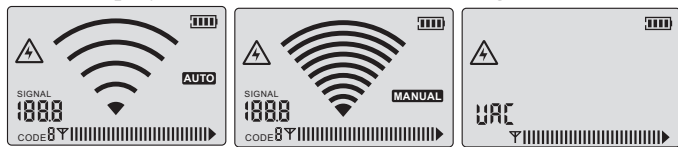

(1) Automatic mode

(2) Manual mode

(3) Mains voltage identification mode

2. CARRYING OUT MEASUREMENT

2.1 Measurement Precautions



WARNING

1. As the connection of the transmitter with the mains supply may generate circuit current of milliampere level, in live condition the Grounding hole of the transmitter can be only connected with a neutral conductor. If transmitter connection is realized from the phase towards the protective conductor, the functional safety of the protective conductor must be tested first, in compliance with DIN VDE 0100. The reason is that when connecting the transmitter from phase towards ground, all parts being connected to the earth may be live in the event of an error (if the earth resistance does not comply with the prescriptions).
2. When the transmitter is connected with live mains, if the Grounding hole of the transmitter is connected with protective ground phase, the current leakage (if any) in the power supply line may join the circuit current of the transmitter, leading to tripping of the leakage circuit breaker, i.e. tripping of FI/RCD.



HINTS

1. When use the transmitter as a voltage tester to test the mains voltage, it will have weak spark at the moment the probes touch the mains voltage, this is normal phenomenon.
2. If any one of the "Start/Stop" key, the "Code Set" key and the "Level Set" key is effective, the other two are ineffective.

2.2 Functional principle

This Cable Locator consists of a transmitter, a receiver and some accessories. The transmitter sends to the target cable (or metal pipes) an AC voltage modulated by digital signals, which generates an alternating electric field (see Fig. 2-1); Put the probe of the receiver close to this electric field, and the sensor will generate induced voltage. This instrument can magnify this weak voltage signal by hundreds of times and then display it via LCD screen after digital processing, so that the position of the buried cables or pipes, as well as their faults, can be detected based on the change of the signal.



CAUTIONS

1. For any application, the connections of the transmitter should ensure a closed circuit.
2. This Cable Locator can only detect or locate lines correctly connected pursuant to the physical principle described.

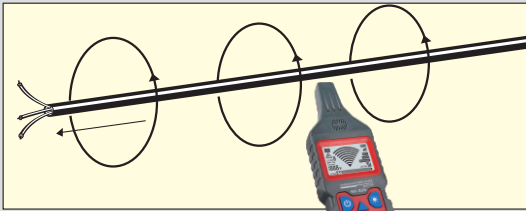

Fig 2-1

! HINTS

Optional connections of this Cable Locator

- One-pole application: Connect the transmitter to only one conductor. Due to the high-frequency signal generated by the transmitter, only one single conductor can be located and traced. The second conductor is the ground. This arrangement causes a high frequency current to flow through the conductor and to be transmitted to the ground, similar to a radio or a receiver.
- Double-pole application: The transmitter is connected to the conductor by two test leads. This application includes live mains and dead mains.
 - The transmitter is connected to live mains: Connect the "+" hole of the transmitter to the phase line of mains and the Grounding hole of the transmitter to the neutral line of the mains. Under this circumstance, if there is no load in the mains, the modulated current from the transmitter will go to the neutral line via coupling through the distributed capacitance in the mains and then return to the transmitter.
 - The transmitter is connected to dead mains: Connect the hole of the transmitter to a terminal of a line in the mains, connect the Grounding hole of the transmitter to another parallel line in the mains, and then connect the other two terminals in the mains with each other. Under such circumstance, the modulated current will directly return to the transmitter through the mains. Optionally, the two test leads of the transmitter can be respectively connected to the two ends of the conductor. Besides, the "+" hole of the transmitter can be connected to a terminal in the mains while the Grounding hole of the transmitter can be connected to the protective grounding terminal of the mains.

2.3 Examples of Typical Application

In this example, please take a piece of a shielded cable with a cross sectional area of 1.5mm² Provisionally install 5m of this cable along the wall with nail clips at eye level as surface mounting. Make sure that the wall is accessible from both sides. Create an artificial interruption at a distance of 1.5m before the line terminal. The line terminals must be open. Strip the interrupted lead at the beginning of the light shielded cable and connect it via the test leads (provided) with hole (Ⓜ) of the transmitter. Connect terminal (Ⓜ) of the transmitter to a suitable ground. All other cable leads must also be connected to the transmitter and the same ground (See Fig. 2-2).

Switch on the transmitter via key (Ⓜ), when the LCD screen of the transmitter will display the initial screen and the buzzer will buzz. Press key (Ⓜ) of the transmitter to enter the screen for setting transmitting level and then press up key (▲) or down key (▼) to select transmitting power level (Level I, II or III). After this level is set, press key (Ⓜ) to exit. If you want to change the transmitting code, press key (Ⓜ) of the transmitter for about 1 second and then press up key (▲) or down key (▼) to select transmitting code (A,C,E,F,H or L, with default A). Press key (Ⓜ) to exit. Then, press key (Ⓜ) to send information. At this moment, the concentric circles (Ⓜ) on the LCD display will be gradually spread, and symbol (Ⓜ) will display the transmitting code received by the transmitter itself, and symbol (Ⓜ) will display the signal intensity. Press key (Ⓜ) of the receiver to power on the receiver, when the LCD screen of the receiver will display the initial screen, the buzzer will buzz, and the receiver will enter the default "Automatic Mode". Move the probe of the receiver slowly along the cable to the interruption position, when symbol (▼) of the receiver will display transmitting power level, (Ⓜ) will display the code transmitted by the transmitter, (▲) will display the dynamic signal intensity, and the loudspeaker will change tone with the change in signal intensity. When the probe of the receiver passes the interruption position, the signal intensity as displayed by (Ⓜ) will have an obvious drop it completely disappears. At this moment, press MANUAL key (Ⓜ) of the receiver to switch it to manual mode and then use key (▲) and (▼) to reduce the sensitivity as much as possible while ensuring that the receiver's screen can display the code transmitted by the transmitter. Then, this area is where the interruption located.

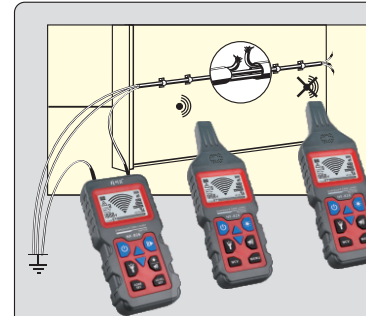

Fig 2-2

! HINTS

- Full grounding should be ensured.
- Adjust the transmitting power level of the transmitter to adapt it to different detection radiuses.
- The best practice for testing is to mark the interruption position on the other side of the wall. Press MANUAL key of the receiver to switch it to manual mode. Press key (▲) and (▼) to reduce the sensitivity to make sure that the signal is just receivable. Trace the signal in front of the wall with the receiver till it is no longer indicated. The interruption position can be further localized through such adjustment.

3. DETAILS OF APPLICATION

3.1 In open circuit

- ※ Detecting line interruptions in wall or floor;
- ※ Finding and tracing lines, sockets, junction boxes, switches, etc. for house installations;
- ※ Finding bottlenecks, kinking and buckling and obstructions in installation pipes by means of a metal wire.

⚠ CAUTIONS

When using this application, please ensure the good functioning of the protective ground wire.

⚠ HINTS

1. Application in open circuit is suitable for finding sockets and switches in dead equipment
2. The tracing depth is depending on the medium and application. A typical tracing depth is 0 ~1m.
3. The protective terminal of an electrical outlet can be used as the grounding connection of the transmitter.

3.1.1 Locating of line interruptions

Preconditions:

- ※ The circuit must be dead.
- ※ All lines which are not required must be connected to the auxiliary ground in accordance with Fig. 3-1-1.
- ※ Connect the transmitter to one lead and to an auxiliary ground according to Fig.3-1-1.

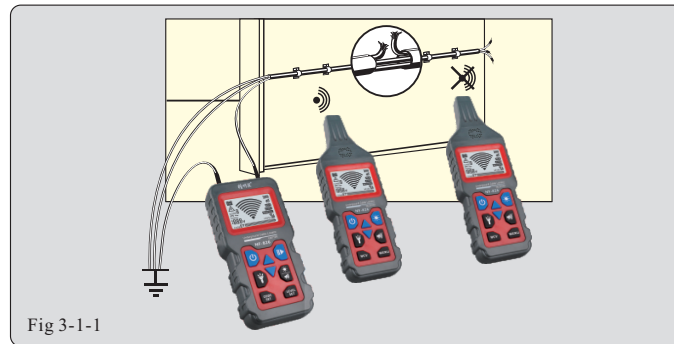

Fig 3-1-1

⚠ CAUTIONS

1. Full grounding should be ensured.
2. The transition resistance of a line interruption must be higher than 100k Ohm.
3. When tracing line interruptions in multi-core cables, note that all remaining leads in the shielded cable or conductor must be grounded in accordance with the regulations. This is required to avoid cross-coupling of the fed signals (by a capacitive effect to the source terminals). The tracing depth for shielded cables and conductors are different, as the individual leads in the shielded cables are twisted around themselves.

⚠ HINTS

1. The ground connected to the transmitter can be an auxiliary ground, earth from an earthed socket or a water pipe which is properly earthed.
2. During tracing along the line, the position at which the signal received by the receiver has an abrupt decline is the position of the interruption.
3. Adjust the transmitting power level of the transmitter to adapt it to different detection radiuses.
4. The target position can be precisely located by your setting of the manual mode of the receiver and selecting of the proper sensitivity.

3.1.2 Locating and tracing of lines and sockets

Preconditions:

- ※ The circuit must be dead.
- ※ Neutral line and protective ground wire must be connected and fully operational.
- ※ Connect transmitter to phase line and protective ground wire according to Fig.3-1-2.

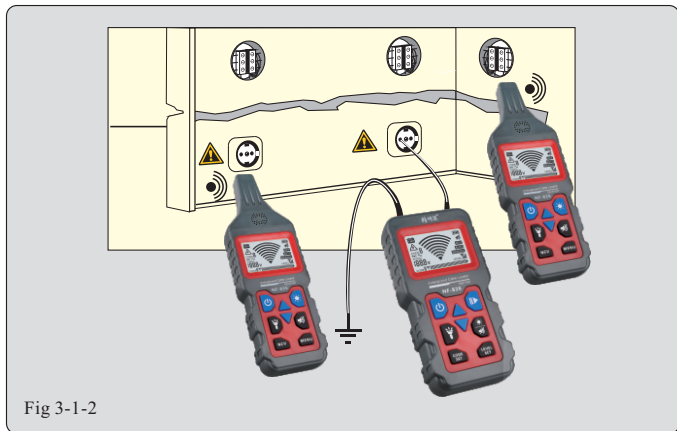

Fig 3-1-2

! HINTS

1. Full grounding should be ensured.
2. With the one-pole indication, also lateral circuit branches can be traced (The fuse must be removed in this example).
3. If the supply cable fed with the signals via the transmitter is located, e.g. directly in parallel to other conductors (e.g. cable groove or duct), or if these conductors are crossed, the signals are also input into the other conductors.
4. During locating and tracing, the stronger the signal displayed, the closer the locator is to the lines to be traced.
5. Adjust the transmitting power level of the transmitter to adapt it to different detection radiuses.
6. The target position can be precisely located by your setting of the manual mode of the receiver and selecting of proper sensitivity.

3.1.3 Detect the narrow (blocked) part of the laid non-metallic pipeline

Preconditions:

- ※ The pipeline must be made of non-conductive materials (such as plastic);
- ※ The pipeline must not be charged;
- ※ The transmitter is connected to a metal helical tube (metal tube or flexible conduit) and an auxiliary ground wire, as shown in Fig.3-1-3;
- ※ The measuring method is the same as that used in the example.

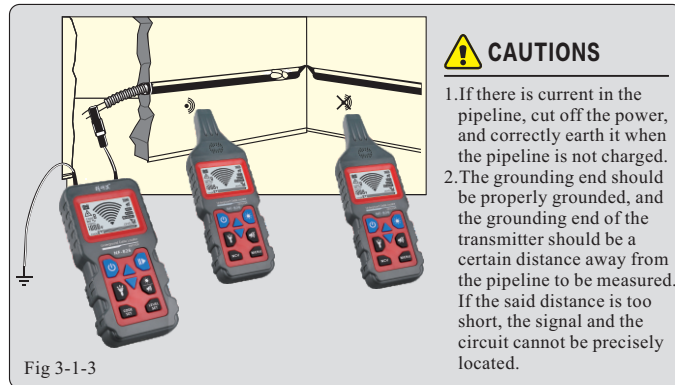

Fig 3-1-3

! CAUTIONS

1. If there is current in the pipeline, cut off the power, and correctly earth it when the pipeline is not charged.
2. The grounding end should be properly grounded, and the grounding end of the transmitter should be a certain distance away from the pipeline to be measured. If the said distance is too short, the signal and the circuit cannot be precisely located.

! HINTS

1. If you only have one helical tube that is made of non-conductive material (such as made of fiberglass), we suggest that you insert a metal wire with the section area of about 1.5mm² into the non-conductive helical tube, and then push it into the narrow part.
2. In the process of detecting the pipeline, the stronger the signals displayed on the Nixie tube of the detector, the closer the pipeline detected by the detector.
3. In the process of detecting along the pipeline, if the signals received by the receiver is suddenly attenuated, the detected position is where the blockage locates.
4. Adjust the transmitting power of the transmitter to adapt to different radiuses of detection.

3.1.4 Detect the laid metal tap water pipe and metal heating pipe

Preconditions:

- ※ The pipeline must be made of metal materials (such as galvanized steel pipe);
- ※ The pipeline to be detected should not be grounded. There should be a relatively high resistance between the pipe and the soil (otherwise the distance of detection will be very short);
- ※ Use a connection wire to connect the "+" socket on the transmitter to the pipeline to be detected.
- ※ The detection of laid tap water pipe and heating pipe is shown in Fig.3-1-4a and Fig.3-1-4b respectively:

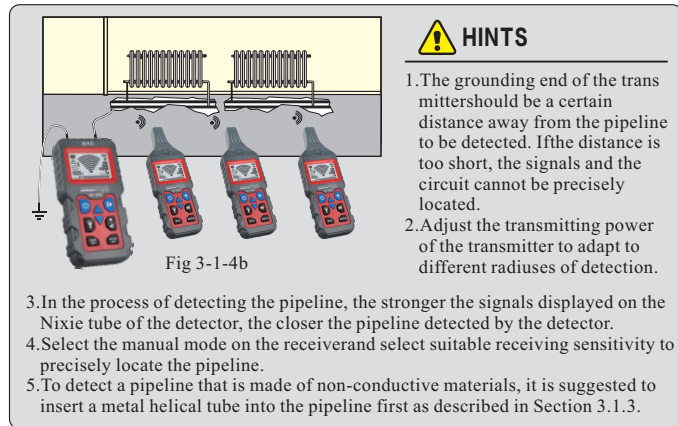
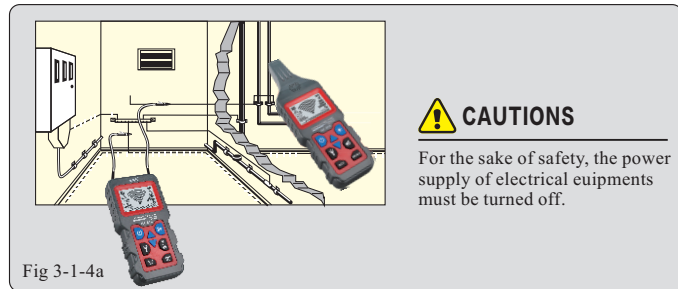

3.1.5 Locating of line interruptions using two transmitters

When locating a line interruption using one transmitter to feed from one conductor end, the location of interruptions may not be precisely located in case of bad conditions due to a field disturbance. The drawbacks described above can easily be avoided when one uses two transmitters (one from each end) for line interruption detection. In this instance, each of the transmitters are set to a different line code, e.g. transmitter one to code F and the other to code C. (A second transmitter with a different line code is not included within the scope of supply and, therefore, has to be ordered separately.)

Preconditions:

- ※ The current circuit must not be live.
- ※ All lines not being used must be connected to the auxiliary ground as shown in Fig.3-1-5.
- ※ Connect both transmitters as shown in Fig. 3-1-5.
- ※ Proceed as described in the application example.

If the transmitters are connected in accordance with Fig. 3-1-5, the receiver indicates C on the left side of the line interruption. If the receiver goes beyond the interruption position towards the right, it will display F. If you are directly above the interruption, no line code is displayed, due to the overlapping of both transmitter signals.

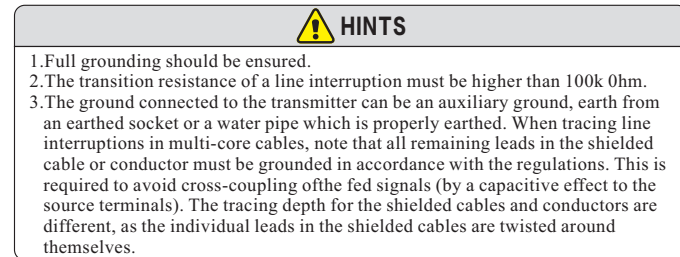
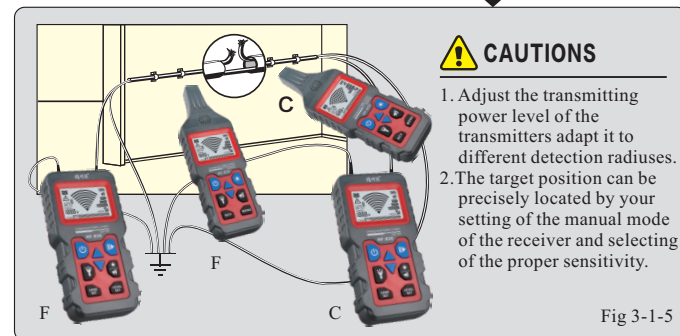

3.1.6 Error detection for an electrical floor heating

Preconditions:

- ※ The current circuit must not be live.
- ※ All lines not being used must be connected to the auxiliary ground as shown in Fig. 3-1-6a.
- ※ Connect both transmitters (if two transmitters are used) as shown in Fig. 3-1-6b.
- ※ Proceed as described in the application example.

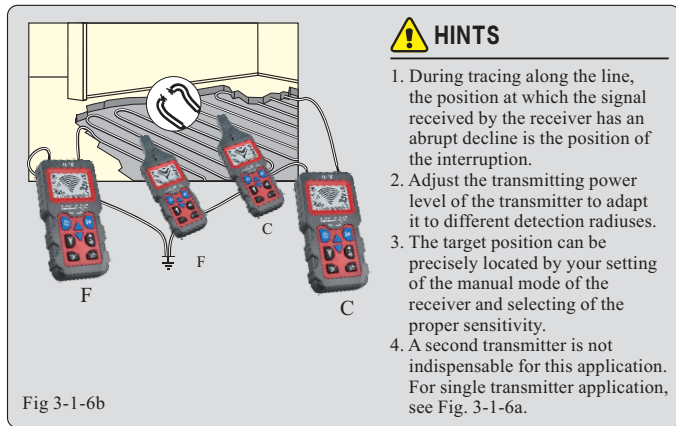
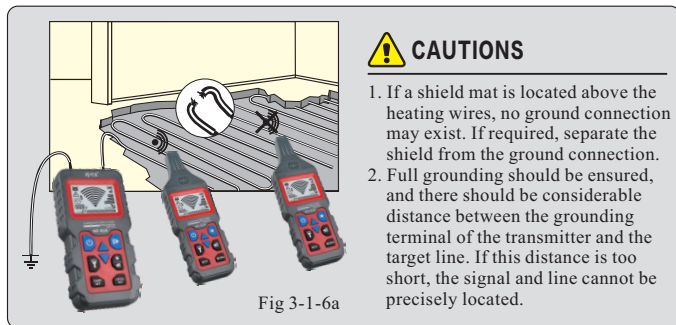

3.1.7 Track an underground circuit

Preconditions:

- ※ The circuit must not be charged;
- ※ Connect the transmitter in a way shown in Fig.3-1-7;
- ※ The grounding end of the transmitter must be properly grounded;
- ※ Select the automatic mode of the receiver;
- ※ Use the displayed signal strength to search or track the circuit.

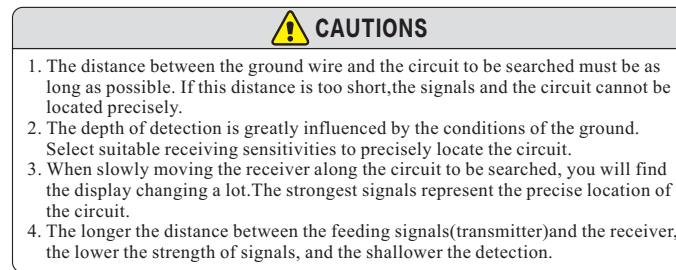
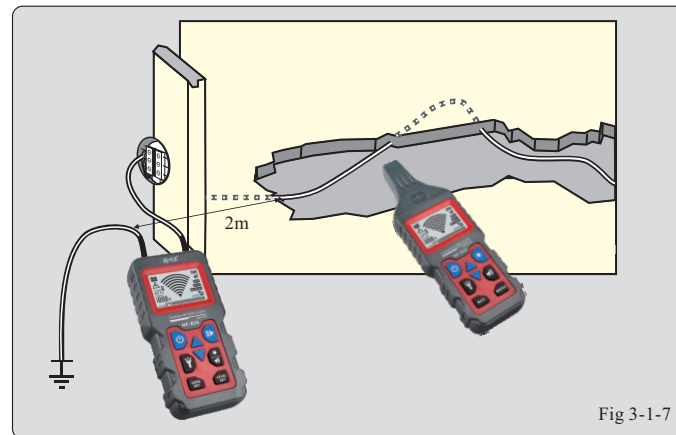

3.1.8 Detect the power supply circuit on the same floor

When detecting the power supply circuit on the same floor, please take the following steps:

- 1). Turn off the main switch in the distribution box of this floor;
- 2). Disconnect the neutral wire in the distribution box of this floor from the neutral wires of other floors;
- 3). Connect the transmitter in a way shown in Fig.3-1-8.

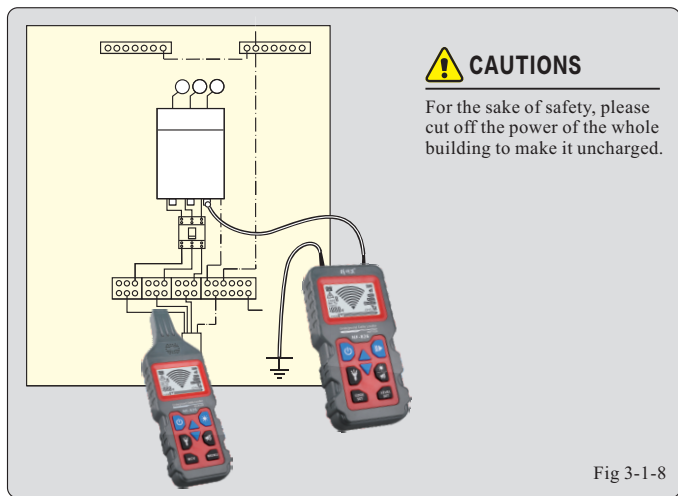

HINTS

1. The grounding end of the transmitter should be properly grounded, and should be a certain distance away from the pipeline to be detected. If the distance is too short, the signals and the circuit cannot be precisely located.
2. Adjust the transmitting power of the transmitter to adapt to different radiuses of detection.
3. In the process of detecting and tracking the pipeline, the stronger the signals displayed on the Nixie tube of the detector, the closer the pipeline detected by the detector.
4. Select the manual mode on the receiver and select suitable receiving sensitivity to precisely locate the pipeline.

3.2 Dual-pole Applications

3.2.1 Search for the fuses

In a building with multiple residences, use the L and N ports on the socket of any residence to feed the signals from the transmitter (as shown in Fig.3-2-1), and adjust the transmitting power of the transmitter to a suitable level.

Preconditions:

- ※ Turn off all the air switches in the distribution box;
- ※ Connect the transmitter according to Fig.3-2-1.

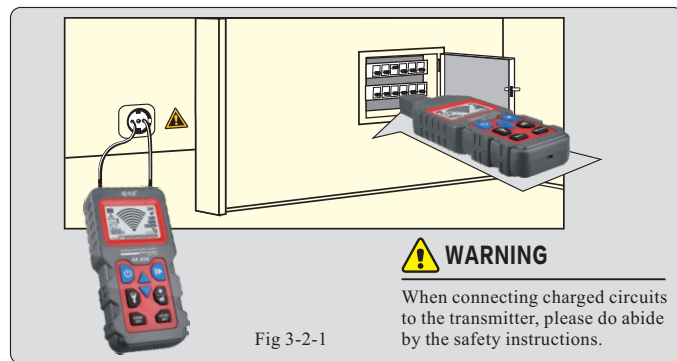

CAUTIONS

1. The identification and positioning of fuses are greatly influenced by the wiring situation in the distribution panel. In order to search for fuses as precisely as possible, one should open or dismantle the cover of the distribution panel, and search for the feeder of fuse.
2. In the searching process, the fuse with the strongest and the most stable signals is the target to be searched for. Due to the coupling of signals, the detector may detect signals from other fuses, but the strengths of those signals are relatively weak.

HINTS

1. When detecting, it is better to put the probe of detector into the inlet of the fuse box to achieve the best result of detection.
2. Adjust the transmitting power of the transmitter to adapt to different radiuses of detection. Select the manual mode on the receiver and select suitable receiving sensitivity to precisely locate the circuit.

3.2.2 Search for short circuit in the circuit

Preconditions:

- ※ The circuit must be uncharged;
- ※ Connect the transmitter according to Fig.3-2-2;
- ※ The measuring method is the same as that shown in the example.

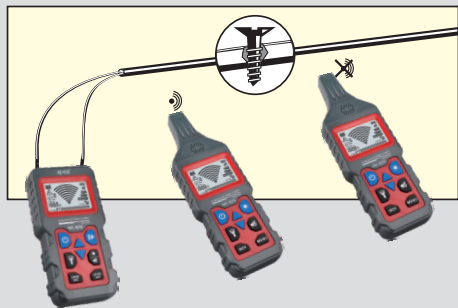

Fig 3-2-2

CAUTIONS

- 1.If there is current in the cable, cut off the power first to turn it into an uncharged state.
2. When searching for short circuits of coated electric wires and cables, the depths of detection vary as the core wires are twisted together in the jacket. According to experience, only the short circuits with the impedance lower than 20 ohm can be correctly detected. The impedance of short circuit can be measured with a multimeter.

HINTS

- 1.If the impedance of short circuit is higher than 20 ohm, try to use the method to search for breakage in circuit to search for the short circuit In order to do that, use a relatively high current to temporarily connect the part with flaw (low ohm connection) or break it.
- 2.In the process of detecting along the pipeline, if the signals received by the receiver is suddenly attenuated, the detected position is where the short circuit locates.
- 3.Adjust the transmitting power of the transmitter to adapt to different radiuses of detection.
- 4.Select the manual mode on the receiver and select suitable receiving sensitivity to precisely locate the circuit.

3.2.3 Applications in closed circuits

It can be applied to charged circuits and uncharged circuits:

In uncharged circuits, the transmitter only sends encoding signals to the circuit to be detected.

In charged circuits, the transmitter not only sends encoding signals to the circuit to be detected, but also measures and displays the voltage of the charged circuit. As shown in Fig.3-2-3:

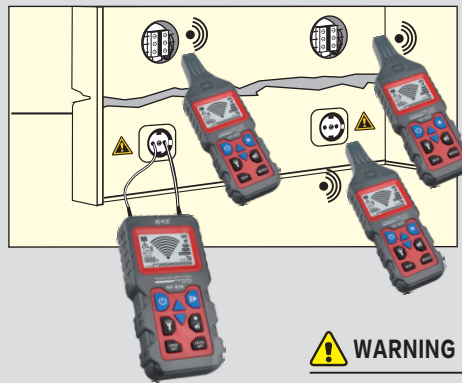

Fig 3-2-3

WARNING

When connecting charged circuits to the transmitter, please do abide by the safety instructions.

HINTS

- 1.The dielectric strength of the transmitter is 400V AC/DC.
- 2.The closed circuit application is suitable for searching sockets, switches and fuses, etc, in the electrical installations of charged or uncharged floors.
- 3.The depth of detection is related to the media of the cable laid and the way of usage, and the common depth of detection is shorter than 0.5m.

3.2.4 Classify or determine the laid circuit

Preconditions:

- ※ The circuit must be uncharged;
- ※ The ends of core wires must be twisted together and conduct with each other;
- ※ Connect the transmitter in a way shown in Fig.3-2-4;
- ※ The measuring method is the same as that in the example.

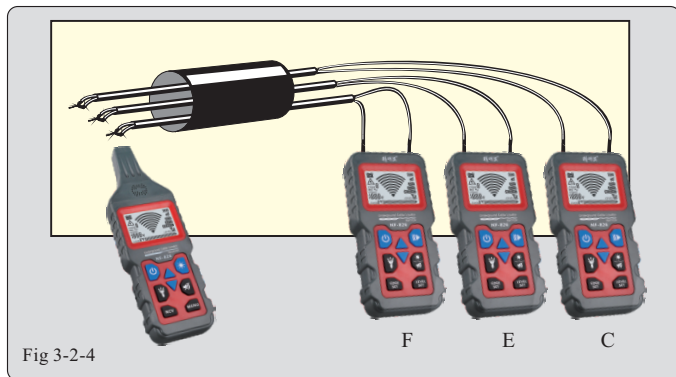

Fig 3-2-4

CAUTIONS

- 1.If there is current in the cable, cut off the power first to turn it into an uncharged state.
- 2.The ends of core wires without shield must conduct with each other, and must be twisted together.
- 3.If there is only one transmitter for use, conduct multiple measurements by changing the connection between the transmitter and the cable core wire.

HINTS

- 1.When changing the connection between the transmitter and cable core wire, different circuits can be distinguished if we change the transmission encoding of the transmitter.
- 2.Adjust the transmitting power of the transmitter to adapt to different radiuses of detection.
- 3.Purchase a transmitter with different transmission signals when necessary.

3.2.5 Detect circuits laid relatively deep

In dual-pole applications, if the loop line is made of core wires in cables with multiple core wires (such as NYM 3*1.5mm²), the depth of detection will be greatly limited. The reason is that the short distance between the feeding line and the loop line causes a seriously distorted magnetic field. Magnetic field with sufficient strength cannot be built up at the narrow parts. If a separate loop line is used, this problem would be easily solved, as the separate conductor can make the magnetic field diffused more strongly. The loop line may be any kind of conducting wires or cable reels. The important point is that the distance between the feeding line and the loop line must be longer than the depth of laying, and in practice this distance is commonly 2m or longer.

Preconditions:

- ※ The circuit must be uncharged;
- ※ Connect the transmitter in a way shown in Fig.3-2-5;
- ※ The distance between the feeding line and the loop line must be at least 2~2.5m;
- ※ The measuring method is as shown in the example.

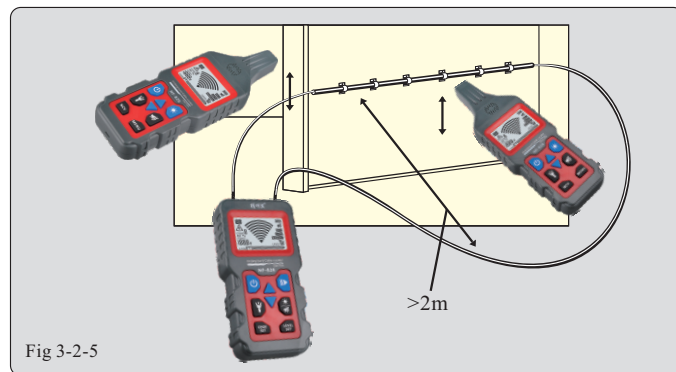

Fig 3-2-5

HINTS

1. In this application, the influence of humidity or mortar on the wall to the depth of locating is insignificant.
2. In the process of detecting the circuit, the stronger the signal displayed on the Nixie tube of the detector, the closer the cable detected by the detector.
3. Adjust the transmitting power of the transmitter to adapt to different radiuses of detection.
4. Select the manual mode on the receiver and select suitable receiving sensitivity to precisely locate the circuit.

3.3 Method to increase the effective radius of detecting charged circuits

When the transmitter is directly connected to the phase line and neutral line, the signals are conducted on two parallel circuits (as shown in Fig.3-3-1), so the twisting of circuits may sometimes cause signals to counteract each other, leading to an effective radius of 0.5m at most. In order to eliminate this effect, the connection must be as shown in Fig.3-3-2, where the loop line uses a separate cable to increase the effective radius to over 2.5m, and loop lines with longer distances can be provided by the cable reel (see Fig.3-3-2).

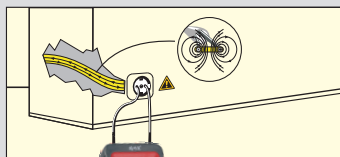

Fig 3-3-1

⚠ WARNING

When connecting charged circuits to the transmitter, please do abide by the safety instructions.

⚠ CAUTIONS

Pay attention to the distance between the transmitter and the circuit to be detected, in order to clearly determine the circuit through signals.

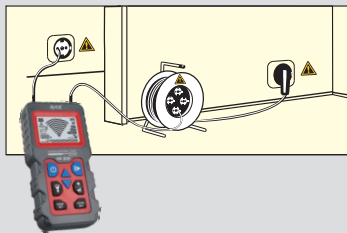

Fig 3-3-2

⚠ CAUTIONS

1. In the process of detecting the circuit, the stronger the signal displayed on the digital tube of the detector, the closer the cable detected by the detector.
2. Adjust the transmitting power of the transmitter to adapt to different radiuses of detection.
3. Select the manual mode on the receiver and select suitable receiving sensitivity to precisely locate the circuit.

3.4 Identify voltage in the grid and search for breakages in the circuit

Preconditions:

- ※ The circuit must be charged with AC voltage;
- ※ The measurement must be conducted according to Fig.3-4;
- ※ Set the transmitter to "Grid Voltage Identification" mode (namely the UAC mode).

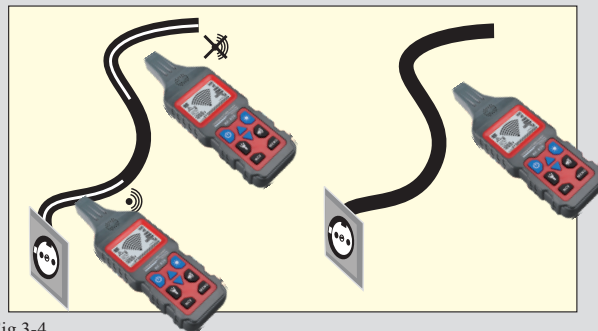

Fig 3-4

⚠ CAUTIONS

1. The AC signals detected by the transmitter in UAC mode only show that whether the circuit is charged, and the precise measurement of voltage should be done through the voltmeter function of the transmitter.
2. When searching for the ends of multiple power lines, it is necessary to connect each line to the phase line separately.

⚠ HINTS

1. This application does not need the transmitter. (Unless you want to use the voltmeter function of the transmitter to precisely measure the voltage in the circuit)
2. The signal strength columns displayed on the transmitter and the signal tone frequency are related to the voltage in the circuit to be detected and the distance to the circuit. The higher the voltage and the shorter the distance to the circuit, the more the columns displayed and the higher the signal tone frequency.

4. OTHER FUNCTIONS

4.1 Voltmeter function of the transmitter

If the transmitter is connected to a charged circuit and the external voltage is higher than 12V, the lower left part of the monitor of transmitter shows current value of voltage, and standard symbols are used to distinguish AC and DC circuits (see $\tilde{\text{V}}_{\text{m}}$ in the interface displayed on the transmitter), and the upper part of the monitor shows a lightning symbol with a triangular frame (see Δ in the interface displayed on the transmitter). The range of identification is 12~400V DC/AC (AC: 50~60Hz).

4.2 Flashlight function

Press the flashlight button F on the transmitter or flashlight button F on the receiver to turn on the flashlight function, and press it again to turn off the flashlight function.

4.3 Backlight function

Press the backlight button A on the receiver to turn on the backlight, and press it again to turn off the backlight.

Long press the backlight button A on the transmitter to turn on the backlight, and press it again to turn off the backlight.

4.4 Mute function

Press M on the transmitter to turn off the buzzer, then the buzzer would not make a sound when any button is pressed; press the mute button again to turn off the mute function of the transmitter, and the buzzer function is recovered. Hold onto M on the transmitter for 1 second to turn off the sound, and the buzzer or the speaker of the receiver would not make a sound; Hold on to M on the receiver for 1 second to turn off the mute function, and the functions of buzzer and the speaker of the receiver are recovered.

4.5 Auto power off function

If any button of the transmitter (or receiver) has not been pressed in 15 mins, the transmitter (or receiver) would be automatically turned off. Please press the on/off button to power on the transmitter (or receiver).

5. TECHNICAL PARAMETERS

Technical parameters of transmitter	Output signal		125kHz	
	External voltage identification range		DC 12~400V $\pm 2.5\%$; AC 12~400V(50~60Hz) $\pm 2.5\%$	
	Display			LCD, with function display and column chart
	External voltage's dielectric strength		Max. 400V AC/DC	
	Overvoltage type		CAT III 300V	
	pollution degree		2	
	Power supply		3.7V 1400 mAh Lithium battery	
	Power consumption	MIN current	80mA	
		MAX current	300mA	
	Fuse		F 0.5 A 500V,6.3x32 mm	
	Range of temperature	In work	0°C ~ 40 °C, with maximum relative humidity of 80% (non-condensation)	
		In storage	-20°C ~ 60°C,with maximum relative humidity of 80% (non-condensation)	
	Altitude		Max. 2000m	
	Dimensions (HxW*D)		156 x 80 x32 mm	
Weight		235g with Battery		

Technical parameters of receiver	Depth of tracking		The depth of tracking depends on the material and specific applications	
	Cable locating mode	Single pole application	About 0~1m	
		Dual-pole application	About 0-0.5m	
		Single loop line	Up to 2.5m	
	Grid voltage identification		About 0~0.4m	
	Display			LCD, with function display and column chart
	Power supply		3.7V 1400 mAh Lithium battery	
	Power consumption	MIN current	100mA	
		MAX current	300mA	
	Range of temperature	In work	0°C ~ 40°C,with maximum relative humidity of 80% (non-condensation)	
		In storage	-20°C ~ +60°C,with maximum relative humidity of 80% (non-condensation)	
	Altitude		Max. 2000m	
Dimensions (HxWxD)		226 x 73 x29 mm		
Weight		235g with battery		

6. REPAIR AND MAINTENANCE

- 1.If the detector is suspected of malfunctioning , please confirm that the electrical amperage of the battery is sufficient and the test lead is not broken.
- 2.Before sending back the detector for repair, please dismantle the battery and describe the phenomenon of malfunction,and then properly pack the apparatus to avoid damaging it during transportation. For damages caused during transportation, the company would assume no responsibility.
3. There is a fuse within the transmitter. If it is damaged during the guarantee period, it can only be replaced by technical personnel of the company. If it is damaged after the guarantee period, please replace it with a fuse of the same model by yourself. This fuse is single metal wire fast-melting type, so do not replace it with a helical metal wire of delayed type, otherwise the transmitting power and safety of apparatus cannot be guaranteed.

6.1 Troubleshooting

If the detector does not work properly, please check the items in the table below:

Malfunction	Items to be checked	Measures to be taken
Can not turn on the machine	Has the battery been installed?	Install new batteries
	Is the electrical amperage of the battery too low?	
	Is the polarity of the battery correct?	Check the polarity
Transmitter cannot identify external voltage	Is the contact sound?	Reconnect the line
	Is the probe broken?	Replace the probe
	Has the probe been inserted to the bottom?	Properly insert the probe
	Is the test lead broken?	Replace the test lead
	Has the test lead been inserted to the bottom?	Property insert the test lead
Power supply is cut off during measuring	Is the electrical amperage of battery sufficient?	Replace the battery
	Did the machine automatically turn off ?	Turn on the machine again
The transmitter cannot receive the signals transmitted by itself	Has the transmission button been pressed?	Transmit again
	Is the fuse of transmitter broken?	Send it back to a closest service center

6.2 Checking of the fuse of the transmitter

The fuse of the transmitter can prevent the transmitter from being damaged by overload or wrong operations. If the fuse in the transmitter has already been melted down, the transmitter can only transmit weak signals. If the self-check of transmitter is passed but the signal transmitted is weak, it means that the transmission is sound but the fuse has been melted down. If no signal is found during the transmission status self-check of the transmitter, and the voltage of battery is normal, it means that the transmitter is broken and should be repaired by special technicians.

Specific methods and steps to check the fuse of the transmitter:

- 1) Break all the measuring circuits of the transmitter;
- 2) Turn on the transmitter and put it in the transmitting status;
- 3) Set the transmitting power of transmitter to level I;
- 4) Connect one end of the test lead to the joint①of the transmitter;
- 5) Insert the other end of test lead into the connecting socket of the transmitter;
- 6) Turn on the transmitter to search for the signals from the test lead, and move the probe of the receiver towards the test lead;
- 7) If the fuse is not broken, the value displayed on the receiver will be doubled.

6.3 Cleaning

Use a rag dipped with clean water or neutral detergent to wipe the transmitter, and then use a dry rag to wipe it again.



CAUTIONS

- 1.Before cleaning work, please make sure that the equipment has been turned off, and all the circuits have been cut off.
- 2.During cleaning work, please do not use benzene, alcohol, acetone, ether, ketone, thinner or gasoline, which would make the equipment deformed or decolored.
- 3.After cleaning, use the equipment again when it is completely dry.

7. ACCESSORIES

Transmitter	1pc	Grounding rod	1pc
Receiver	1pc	Carry bag	1pc
Test Lead	1pc for each color (Red/black)	User manual	1pc
Crocodile clamps	1pc for each color (Red/black)	Color box	1pc
Test probe	1pc for each color (Red/black)	Built-in battery	2pc