

htc®



VIVE™

VIVE Cosmos User guide

Contents

System requirements

What's inside the box?	5
What are the system requirements?	5

Headset and headphones

Headset	7
Headphones	25
Common solutions	37

Link box

About the link box for VIVE Cosmos	38
Connecting the headset to your computer via the link box	39
Restarting the link box	39
Can I use older versions of the link box with VIVE Cosmos?	39
Can I use a laptop with VIVE Cosmos?	40
My computer monitor and headset are turned on but why can't I see anything?	40

Converter

About the converter for VIVE Cosmos	41
Connecting the headset to your computer via the converter	42
Restarting the converter for VIVE Cosmos	42
Can I use a laptop with VIVE Cosmos?	43
My computer monitor and headset are turned on but why can't I see anything?	43

Controllers

About the VIVE Cosmos controllers	44
Inserting the batteries into the controller	46
Removing the batteries from the controller	47
Attaching the lanyards to the controllers	47
Turning the controllers on or off	48
Pairing the controllers with the headset	49
Checking the battery level of the controllers	49

Play area

What is the play area?	50
Planning your play area	50
Choosing the play area	51
Setting up VIVE Cosmos for the first time	51
Setting up the play area	52
Resetting the play area	53
What is the recommended space for the play area?	53
Can I include space occupied by furniture for the play area?	53
Does VIVE Cosmos store my room or environment image?	53
Will VR apps that are for limited spaces or stationary experiences only work with a room-scale setup?	53
How do I resolve download errors during VIVE Setup installation?	53

I can't complete the room setup. What should I do?	54
The headset and controllers are not being tracked properly. What can I do?	54

VIVE Reality System

What is VIVE Reality System?	56
What is Lens?	56
What is Origin?	57

Settings

Disabling Volume limit	59
Capturing screenshots in VR	59
Seeing real surroundings	60
Enabling motion compensation	61
Updating the firmware	61
Troubleshooting VIVE Cosmos	61
Joining the VIVE Cosmos beta program	62
Setting the power supply frequency	62
What do the error codes and messages mean? What can I do?	62

Trademarks and copyrights

Index

About this guide

We use the following symbols to indicate useful and important information:



This is a note. It provides detailed information for setup, common questions, and what to do in specific situations.



This is a tip. It will give you an alternative way to do a particular step or procedure that you may find helpful.



This indicates important information that you need in order to accomplish a certain task or to get a feature to work properly.



This is a warning. Take note to avoid potential problems or prevent damage to your hardware.

Information contained in this guide may have changed. For the most up-to-date information, including the latest version of this guide, go to [VIVE Support](#).

Before using the product, carefully review VIVE safety information and follow all product safety and operating instructions on <https://www.vive.com/legal/>.

System requirements

What's inside the box?

Your VIVE Cosmos comes with the following items, which you'll use to experience immersive VR environments:

Main component	Accessories
VIVE Cosmos	<ul style="list-style-type: none"> ▪ Headset cable (attached) ▪ Audio cable (attached) ▪ Top strap (attached) ▪ Face cushion frame with cushions (attached) ▪ Cleaning cloth ▪ On-ear headphones (attached) <p> To use your own headphones with VIVE Cosmos, you'll need the replacement kit for headphones. For details on how to get the kit, contact customer care.</p>
Link box or converter	<ul style="list-style-type: none"> ▪ Power adapter ▪ DisplayPort™ cable ▪ USB 3.0 cable
Controllers (x2)	<ul style="list-style-type: none"> ▪ Lanyards (attached, x2) ▪ AA alkaline batteries (x4)

What are the system requirements?

To use VIVE Cosmos, your computer must meet the following system requirements.

Component	Minimum system requirements	Recommended system requirements
Processor	Intel® Core™ i5-4590/AMD FX™ 8350 equivalent or better	Intel Core i5-4590/AMD FX 8350 equivalent or better

Component	Minimum system requirements	Recommended system requirements
GPU	NVIDIA® GeForce® GTX 970 4GB, AMD Radeon™ R9 290 4GB equivalent or better VR Ready graphics card. Refer to AMD or NVIDIA's VR Ready website for a list of VR Ready graphics cards.	NVIDIA GeForce GTX 1070/Quadro P5000 equivalent or better, AMD Radeon Vega 56 equivalent or better VR Ready graphics card. Refer to AMD or NVIDIA's VR Ready website for a list of VR Ready graphics cards.
Memory	4 GB RAM or more	8 GB RAM or more
Video output	DisplayPort 1.2 or newer	DisplayPort 1.2 or newer
USB port	1x USB 3.0 or newer	1x USB 3.0 or newer
Operating system	Windows® 10	Windows 10

Headset and headphones

Headset

About the VIVE Cosmos headset

The headset is your window to the VR environment.

The headset has cameras that are used for inside-out tracking.



The cameras on the headset are sensitive. Do not cover or scratch the cameras.

Front and side views

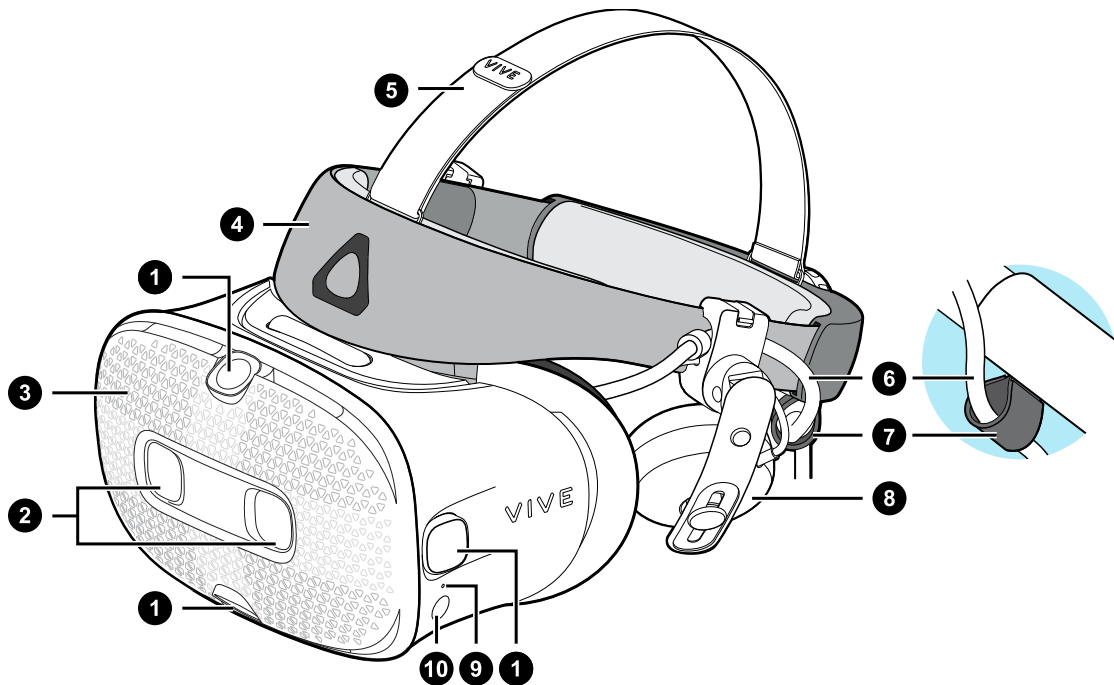

1. Side/tracking cameras
2. Dual cameras
3. Front cover
4. Headset band
5. Top strap
6. Headset cable
7. Headset cable strip

- 8. On-ear headphone
- 9. Status light
- 10. Headset button

Back and bottom views

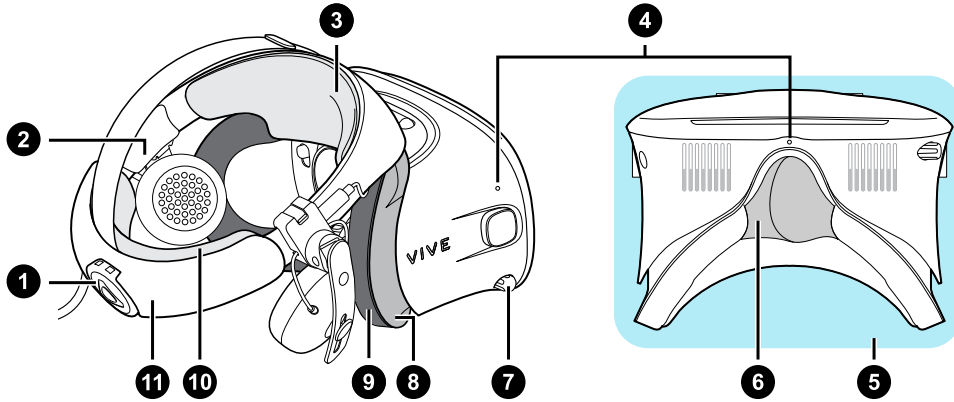

- 1. Adjustment dial
- 2. Side cushion
- 3. Front pad
- 4. Mic
- 5. Visor
- 6. Nose rest
- 7. Interpupillary distance (IPD) knob
- 8. Face cushion frame
- 9. Face cushion
- 10. Back pad
- 11. Headset band

Inner view (face cushion frame removed)

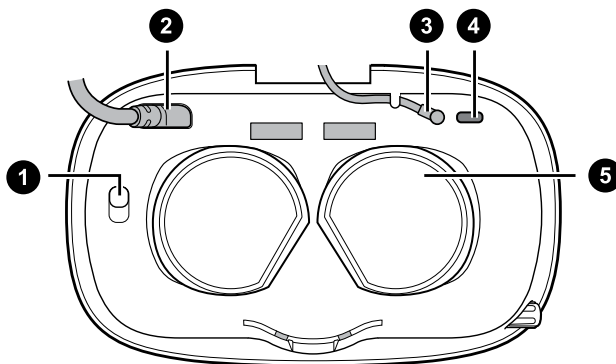

- 1. Front cover lock button
- 2. Headset cable
- 3. Audio cable
- 4. USB Type-C cable slot
- 5. Lenses

Putting on the VIVE Cosmos headset



Before wearing the headset for the first time, make sure to:

- Peel off the protective film on the lenses.
- Fully loosen the band and peel off the protective film starting from the left side of the band.

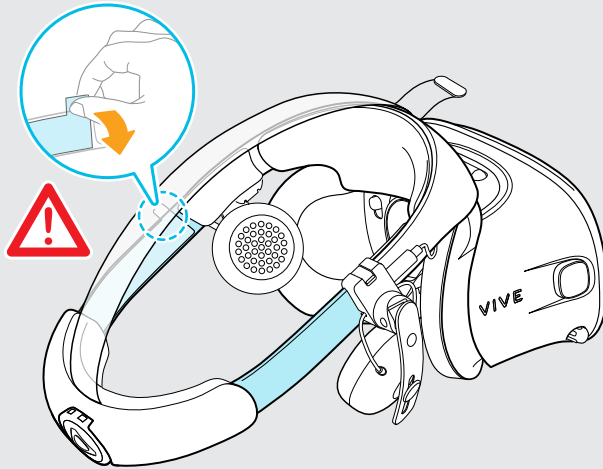

1. Detach the velcro fastener on the top strap, and then loosen the band by turning the adjustment dial counter-clockwise.

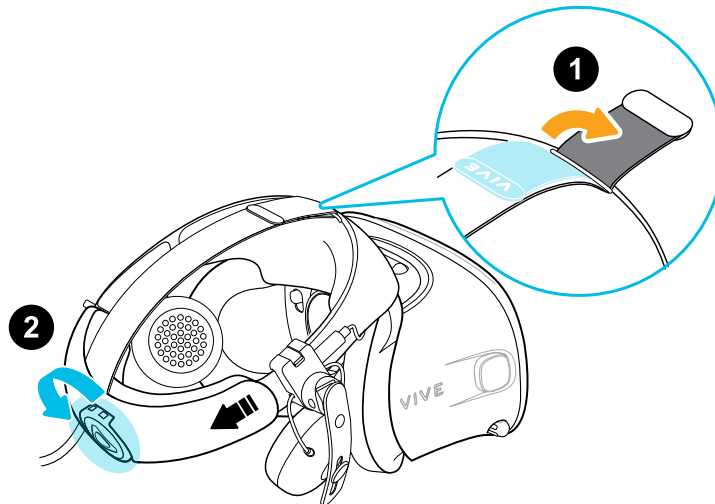

2. While holding the visor with one hand, pull up the band.

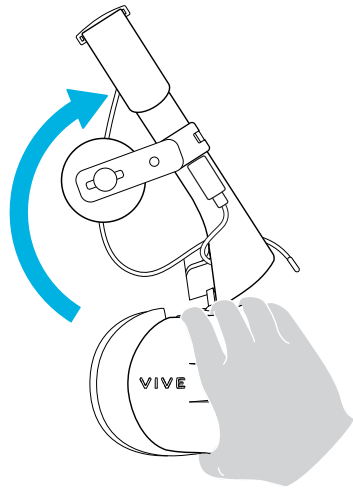

3. Hold the visor to your eyes. Adjust the position of the visor until you see a clear image inside the headset.

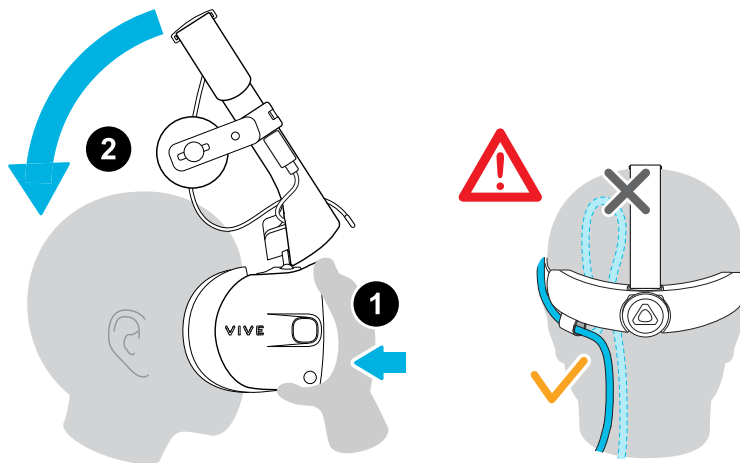

4. Pull down the headset band around the back of your head until you hear a click. The click indicates that the headset band has locked into place.



When you pull down the band, make sure the headset cable is not caught in between the band and your head. Let the headset cable run straight down your back.

5. Turn the adjustment dial clockwise until the headset fits snugly.

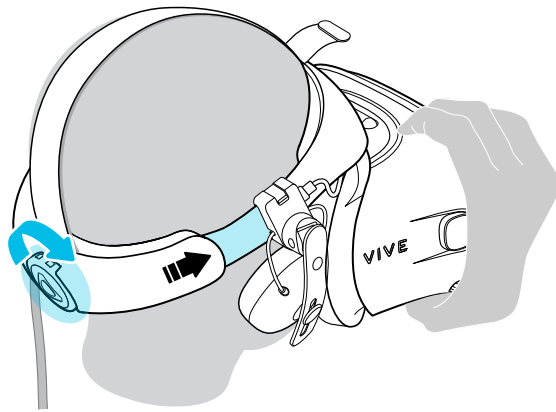

Make sure the visor faces straight ahead. If the band sits too low or high on the back of your head, the visor will be tilted. It will also be difficult to position the on-ear headphones properly on your ears. If there's light leakage around the areas of your nose or cheeks, adjust the position of the band.

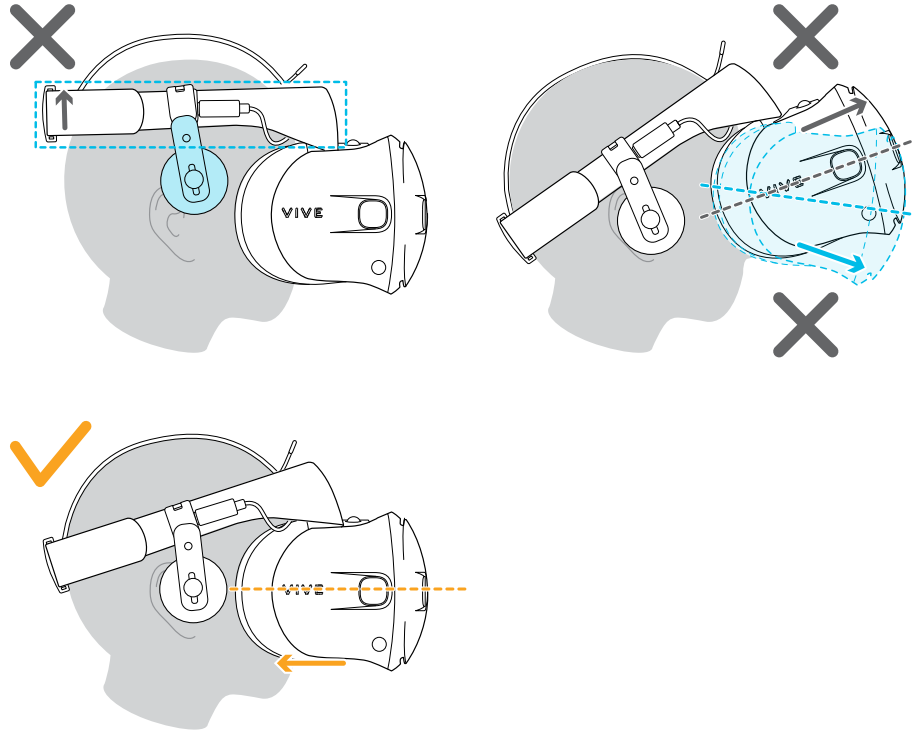

6. Adjust the top strap until snug, and then fasten the velcro strap.

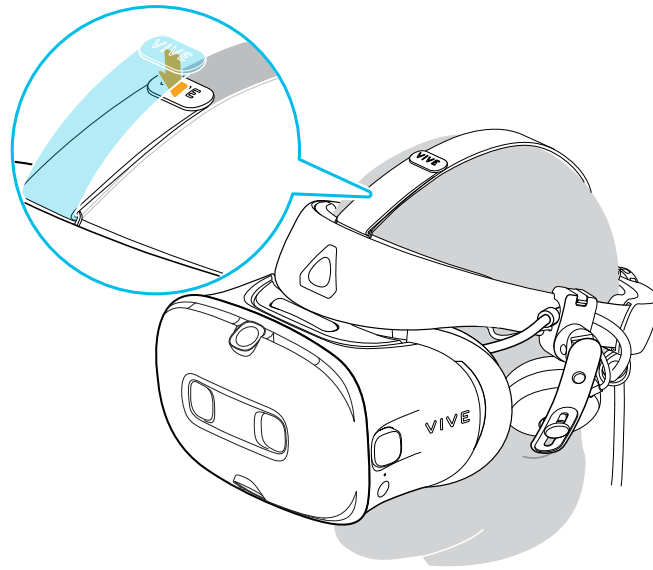

If there's light leakage around the areas of your nose or cheeks, readjust the strap and reposition the band.

Can I wear my prescription glasses while using VIVE Cosmos?

Most glasses fit inside the headset.



Make sure that no part of your glasses scratch the headset lenses.

Adjusting the IPD on the headset

Interpupillary distance (IPD) is the distance between the centers of your pupils. A quick way to get an estimate is by facing a mirror and holding a millimeter ruler against your brow. Use this measurement as a guide to adjust the distance between the lenses of the headset so that you'll have a better viewing experience.

To increase the distance between the lenses, rotate the IPD knob clockwise. To decrease, rotate the IPD knob counterclockwise.

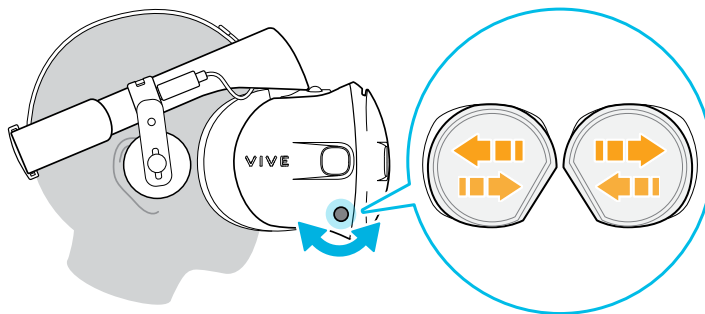

As you adjust the IPD, you'll see a prompt indicating the current distance between the centers of the lenses.

Flipping up the visor

Quickly take a break from VR to check your surroundings.

While wearing VIVE Cosmos, hold the visor with one or both hands, and then gently flip it up.

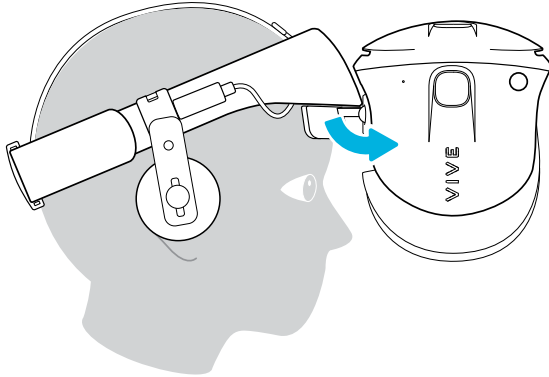

To return it to its original position, tilt the visor down until it completely covers your eyes.

If you wear large glasses, you may need to adjust the headset to sit higher on your head when flipping the visor up or down.

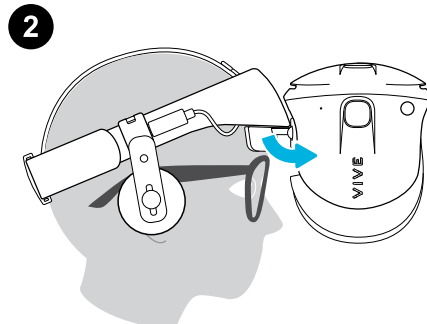
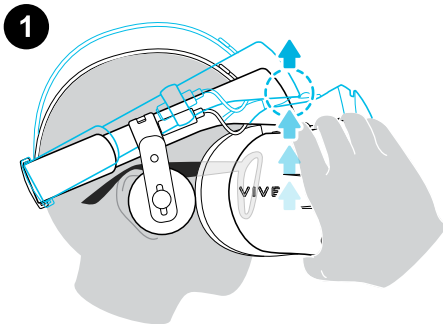

Connecting a USB device to VIVE Cosmos

You can connect a compatible USB Type-C device to VIVE Cosmos using a USB cable.

1. While holding the visor with one hand, pull up the band.

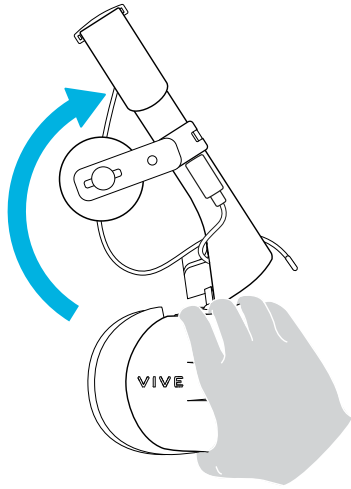

2. Detach the face cushion frame from the headset. To release the frame from its latches, gently pull on any side of the frame starting from the bottom, and then pull one side at a time on the top.

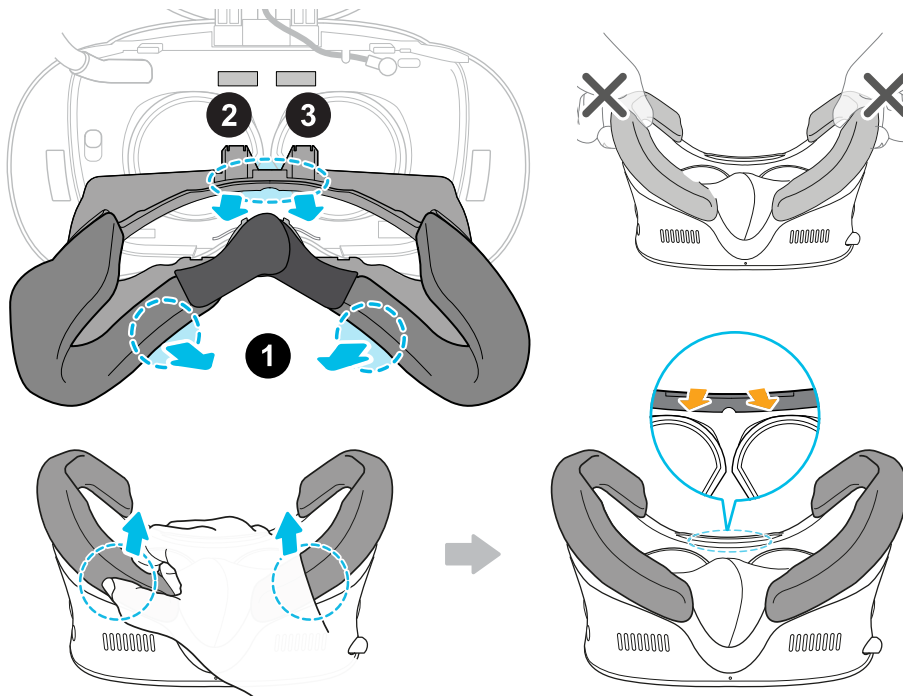

Avoid pulling or squeezing on the sides of the face cushion frame to prevent damaging the frame.

3. Insert the cable connector of the device into the USB Type-C port on the headset.

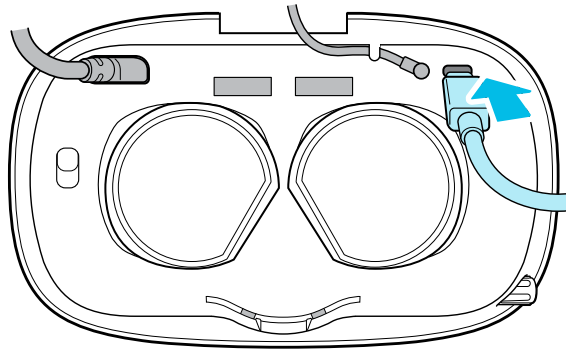

4. Align and push the tabs on the face cushion frame into their corresponding slots on the headset. Make sure to position the ridge of the face cushion frame below the headset, audio, and USB cables. You'll hear a click when the face cushion frame locks in place.

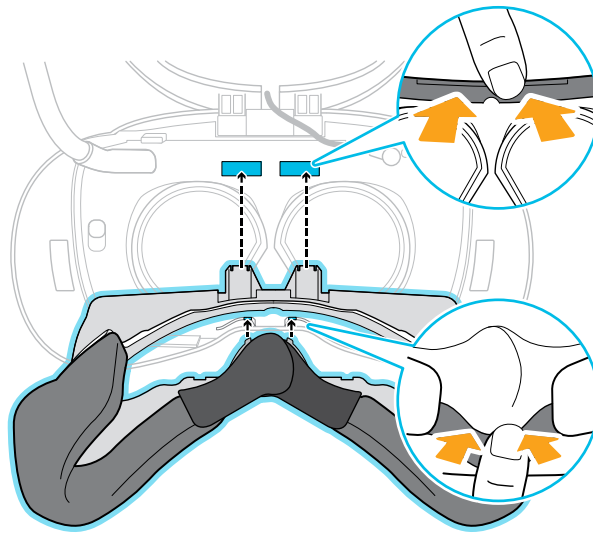

5. Connect the other end of the USB cable to USB Type-C device.

Removing the face cushions

You can remove the face cushions for cleaning. To learn how to clean the face cushion, see [Cleaning the face cushions](#) on page 22.

1. To remove the face cushions, gently peel starting from the bottom ends of each face cushion until they detach from the face cushion frame.

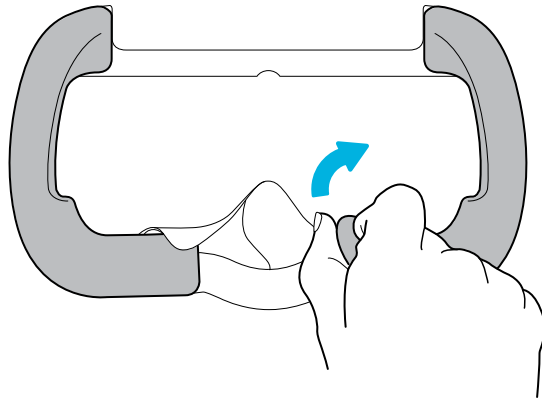

2. To reattach, align one end of the face cushion with the marker on the bottom part of the face cushion frame. Press down the face cushion against the outline of the frame, and then check that the other end of the face cushion lines up with the marker on the top part of the frame.

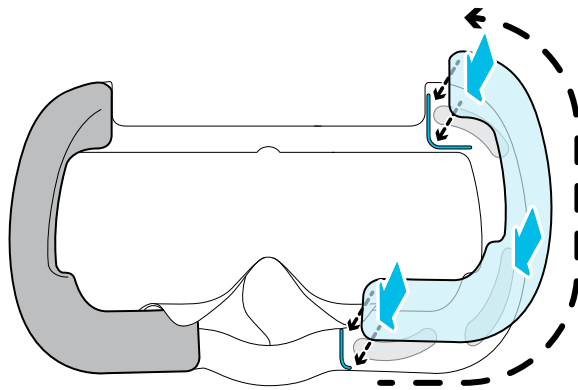

Make sure that the velcro and adhesive strips attach firmly.

Removing the front and back pads

You can remove the front and back pads from the headset band for cleaning.

To remove the front and back pads, peel starting from the ends of each pad until they detach from the headset band.

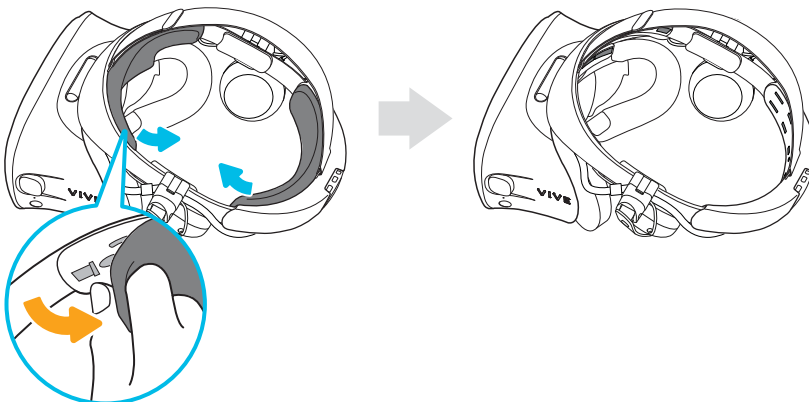

Reattaching the front and back pads to the headset

Always make sure that the front and back pads are attached to the headset.

1. While holding the visor with one hand, pull up the band.

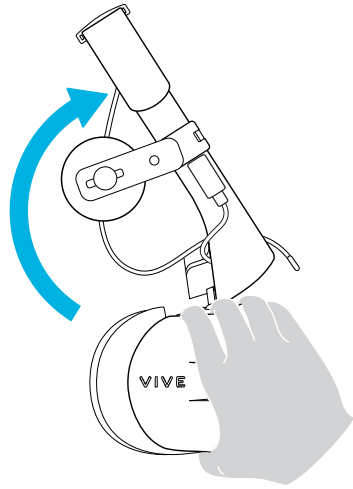

2. Starting from the middle, align the front pad tabs with their corresponding slots on the band, and then press along the front pad. You may need to gently bend the ends of the front pad to align the outermost tabs with the slots on the band.

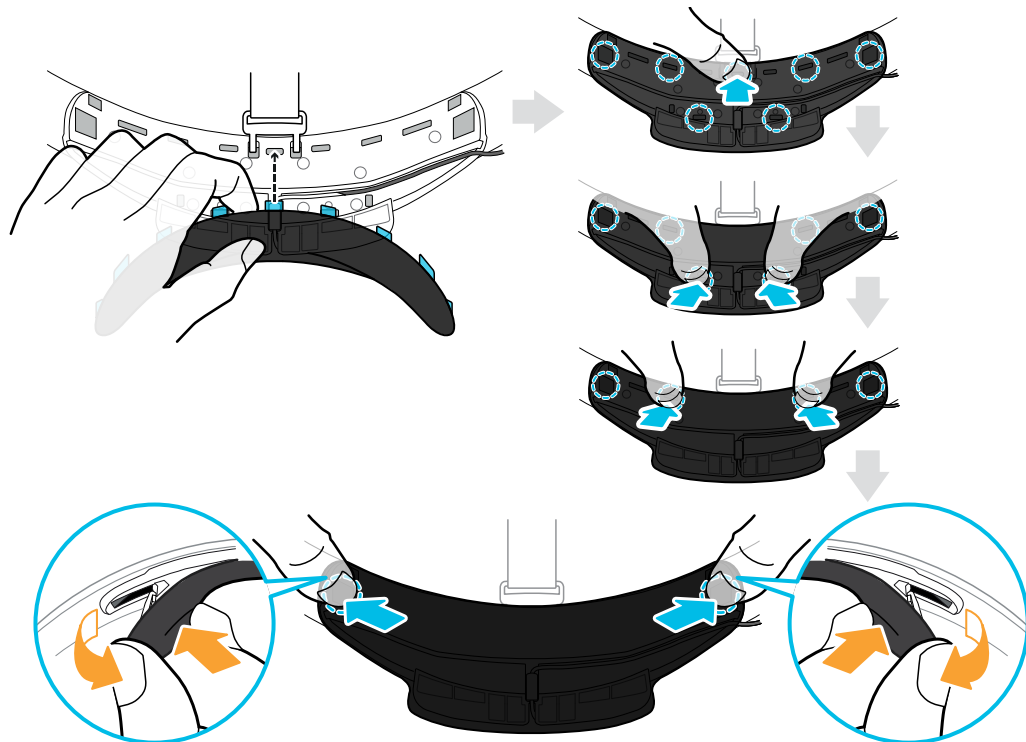

Make sure to minimize the gap between the pad and the band and that all tabs are fully locked into place.

3. Align the back pad tabs with their corresponding slots on the band, and then press along the back pad to reattach.



Check that the headset cable strip is properly attached. For details, see [Reattaching the headset cable strip to the back pad](#) on page 18.

You'll hear a click when the tabs are inserted.

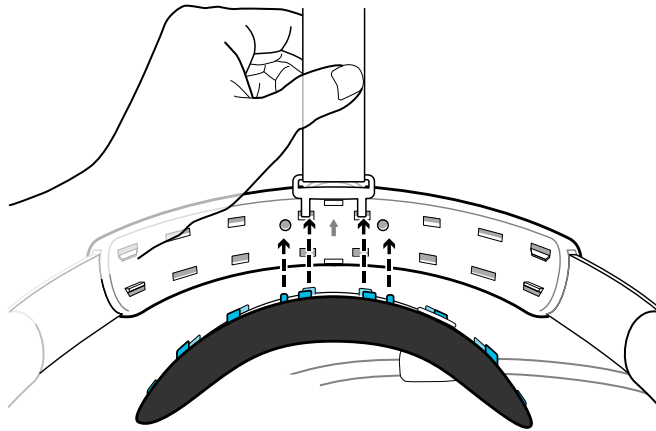

Make sure to minimize the gap between the pad and the band.

Reattaching the headset cable strip to the back pad

The fabric strip guides the headset cable, and is inserted on the back pad.

1. Insert the back pad tabs second to the left-most corner tabs into the holes of the headset cable strip with its flap down. Make sure that the strip is firmly attached.

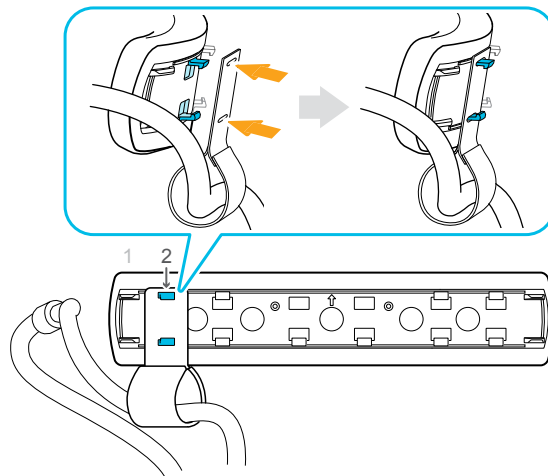

2. Reattach the top strap to the headset band. For details, see [Attaching the top strap to the headset band](#) on page 21.

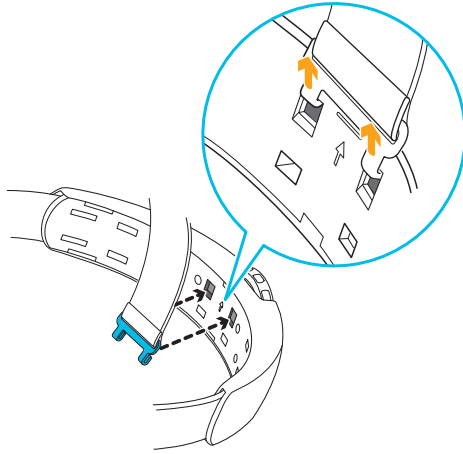

3. Align the back pad tabs with their corresponding slots on the band, and then press along the back pad to reattach. You'll hear a click when the tabs are inserted.

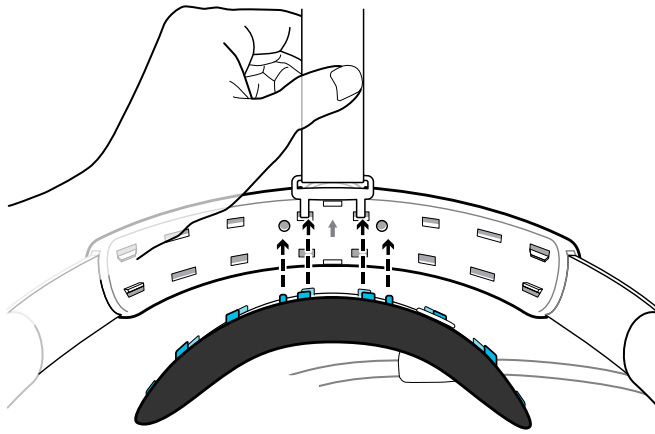

4. Make sure to minimize the gap between the pad and the band.

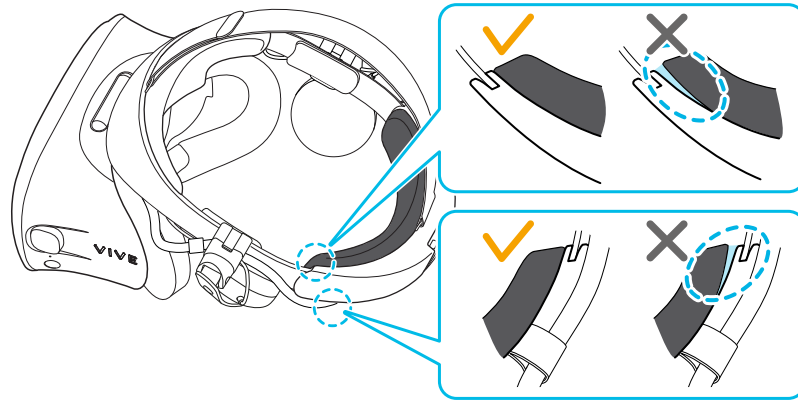

Detaching the top strap from the headset band

If you want to, you can detach the top strap from the headset band.



You'll need to first remove the front and back pads on the headset. For details, see [Removing the front and back pads](#) on page 16.

1. Starting from the rear of the headset band, pull down the strap to unhook it.
2. On the other end of the strap, pull down and out the strap to unhook it.

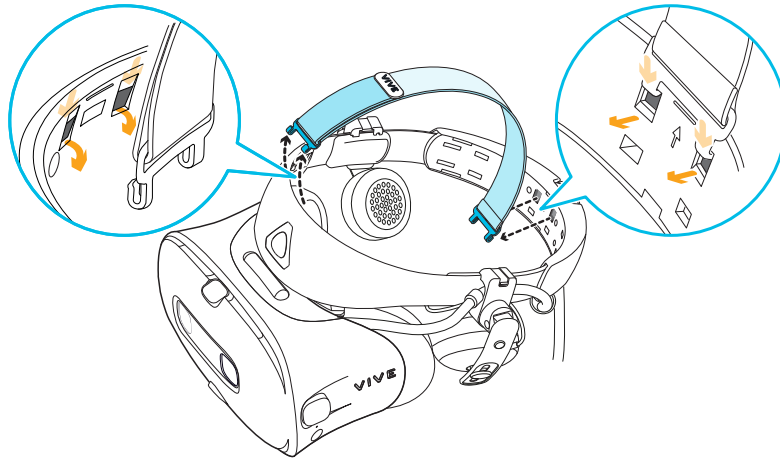

3. Reattach the front and back pads to the headset. For details, see [Reattaching the front and back pads to the headset](#) on page 17.

Attaching the top strap to the headset band

For added comfort, attach the top strap before wearing the headset. You can adjust the top strap by using the velcro strip.



You'll need to first remove the front and back pads on the headset. For details, see [Removing the front and back pads](#) on page 16.

1. Starting from the rear of the headset band, align the hooks of the top strap (side without the clasp) to its corresponding slots. Gently pull up the strap to hook into place.
2. Align and insert the hooks on the other end of the top strap with the inner slots of the headset band, and then pull up on the strap to hook into place.

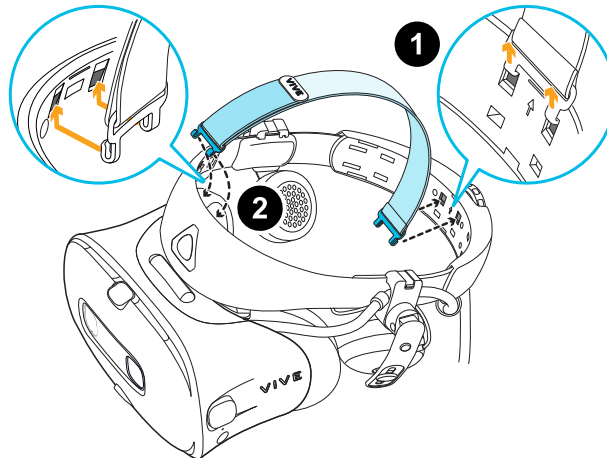

3. Reattach the front and back pads to the headset. For details, see [Reattaching the front and back pads to the headset](#) on page 17.

Cleaning the headset lenses

1. Use the cleaning cloth provided in the box to wipe the lenses.

2. Wipe in a circular motion from the center to the outer edges of the lenses.

While cleaning the lenses, do not scratch the lenses nor disassemble other parts of the headset.

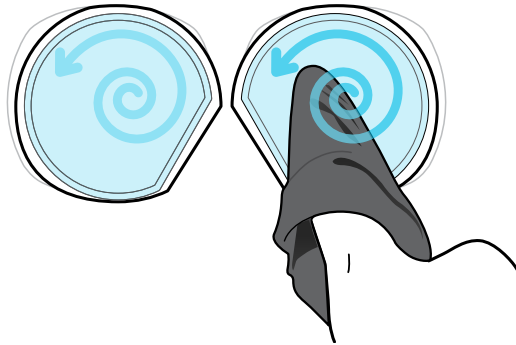

Cleaning the face cushions

1. Before cleaning the face cushions, remove it first from the VIVE Cosmos headset.
2. When cleaning the face cushions, remember to:
 - Dampen a clean smooth cloth with cold water and gently wipe the area you want to clean.
 - Air dry at room temperature. Don't tumble dry, iron, or expose it to direct sunlight.
 - Don't scrub, wring, or bleach.
 - Don't dip or soak in water.



Caring for your VIVE Cosmos

Follow these tips to properly care for your VIVE Cosmos.

- Keep the headset lenses away from sharp objects, including cable tips. This will prevent the headset lenses from being scratched.

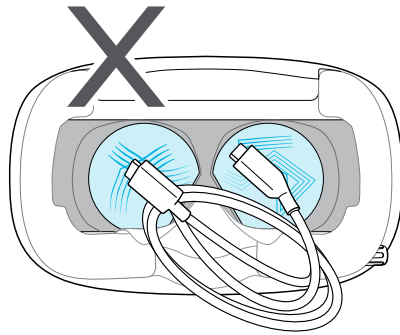

- When not in use, store the headset in a cool, dark, and low humidity environment.
- When not in use, store the headset with the lenses pointed away from direct sunlight. Failure to do so may damage the headset display.
- When storing the headset, it is recommended to cover the lenses with the paper cover to help prevent accidental scratches.

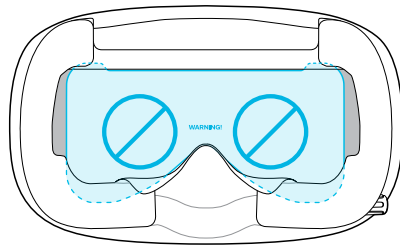

Replacing the front cover

You can replace the front cover on the headset.

1. Slide down and hold the lock button inside the compartment to unlatch the front cover.
2. Pry open the front cover starting from the bottom right corner with the visor facing you.
3. Carefully pull out the front cover until it detaches from the visor.

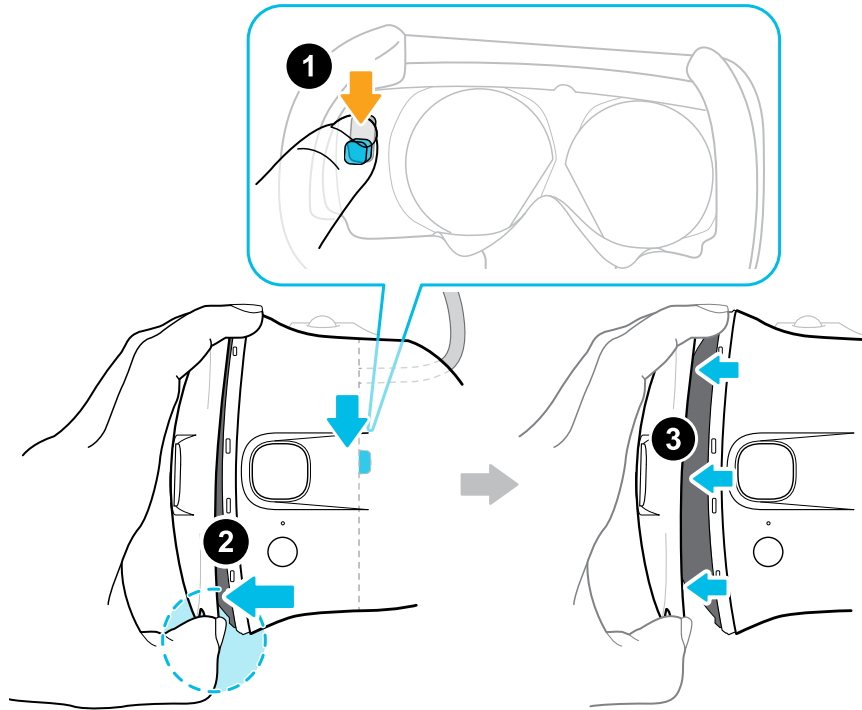

4. Insert the tabs on the replacement front cover into the slots on the visor, and then press down on the front cover.

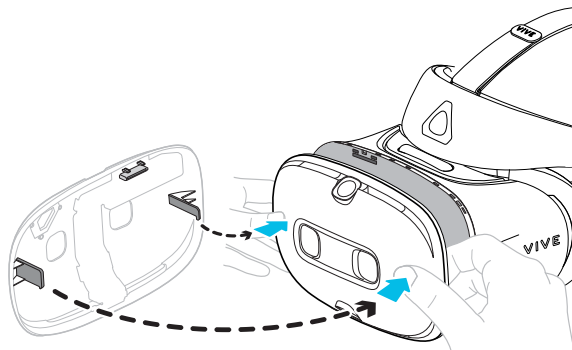

5. Make sure to minimize the gap between the front cover and the visor, and that all tabs are fully locked into place.

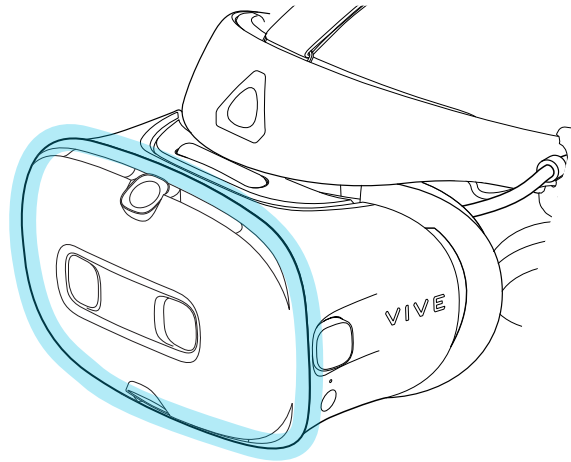

You'll hear a click when the front cover locks in place.

What does the status light on the headset mean?

The status light turns:

- Green when the headset is in normal mode
- Dim green when the headset is on standby
- Red when the headset is in sleep mode
- Flashing green when using camera pass-through mode. See [Seeing real surroundings](#) on page 60.

Headphones

Adjusting the fit of the on-ear headphones

While wearing the VIVE Cosmos headset, adjust the on-ear headphones to a comfortable position over your ears, then press the headphones into place.

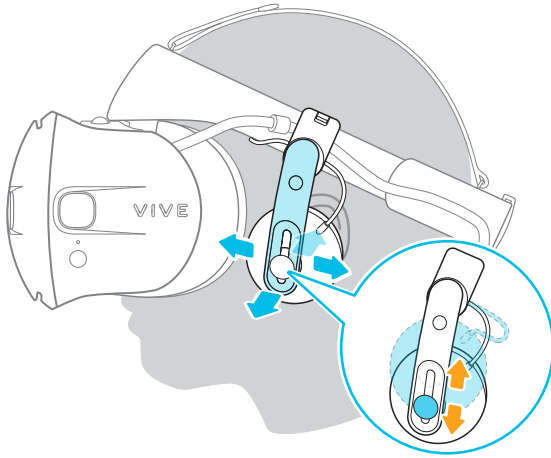

Is the fit too loose or tight? In case you feel pressure around your temples, adjust the position of the on-ear headphones for a more comfortable fit. To do so, flip open the metal clasp on each headphone and reposition the headphone clip on the headset band.

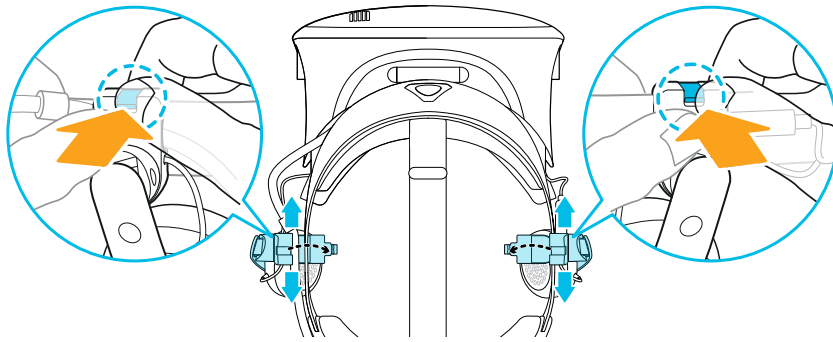

Detaching the on-ear headphones from the headset band



To use your own headphones with VIVE Cosmos, you'll need the replacement kit for headphones. For details on how to get the kit, contact customer care.

Before using your own earphones, you first need to detach the on-ear headphones from the headset band.

1. On the right side of the band, disconnect the audio plug from the audio cable connector.
2. Remove the side cushions and front pad from the headset band. For details, see [Removing the front and back pads](#) on page 16.

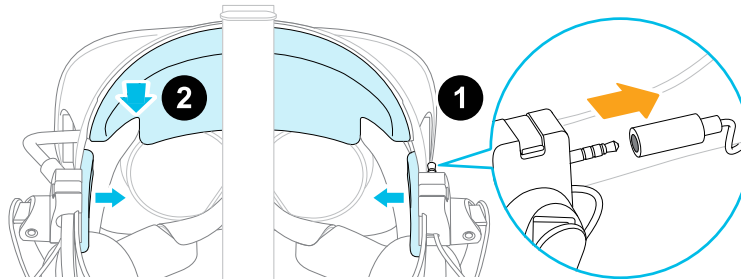

3. On the front section of the band, carefully pull out the cable of the on-ear headphones from the groove.
4. On the left and right sides of the band, flip open the metal clasp of each headphone to detach it.

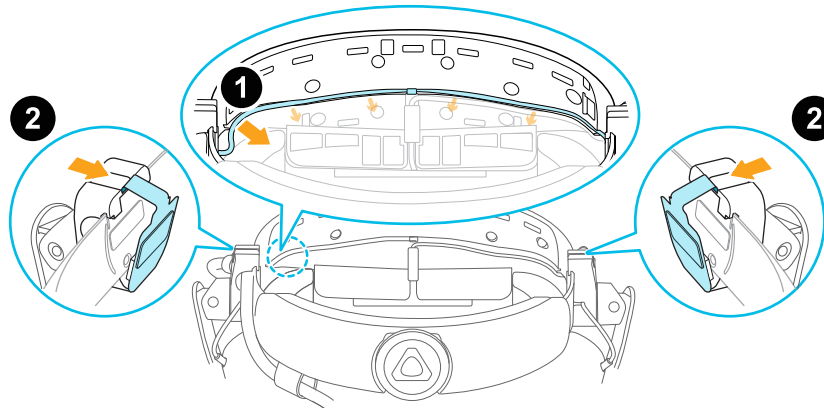

After detaching the on-ear headphones, you need to attach cable guides before plugging in your own earphones. For details, see [Attaching the cable guides to the headset band](#) on page 34.

Reattaching the on-ear headphones to the headset band

You can reattach the on-ear headphones if you've used your own earphones with VIVE Cosmos.

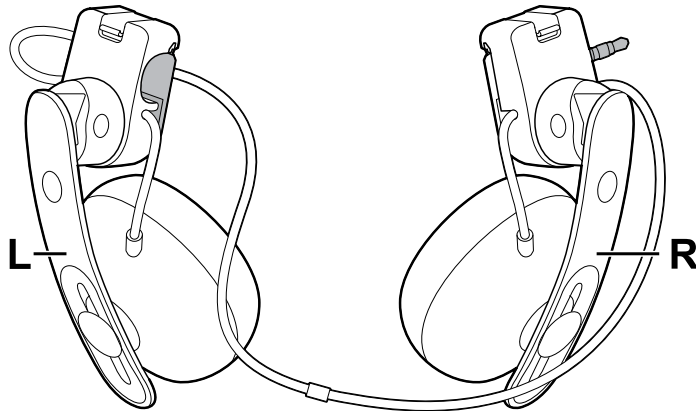

Before attaching the on-ear headphones to the headset band, do the following:

1. Remove the cable guides, screws, and rubber pad, which are part of the replacement kit for earphones, as well as the side cushions from the headset band. For details, see [Detaching the cable guides from the headset band](#) on page 35.

Use a cross-shaped screwdriver (PH00) to detach the screws. Make sure to keep these parts in a safe place.

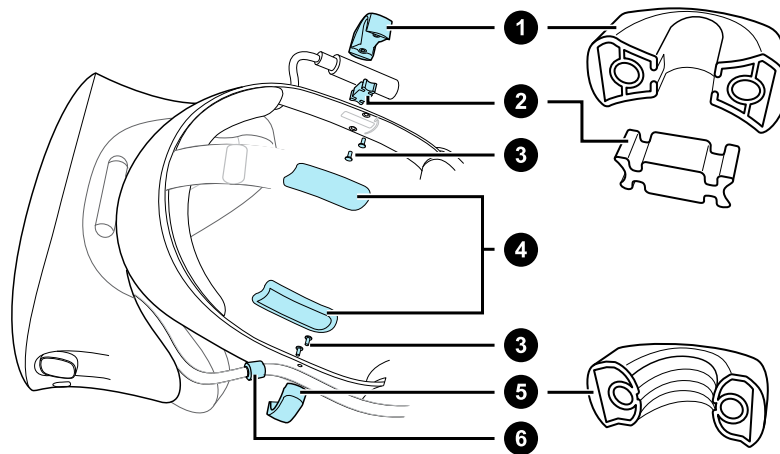

1. Audio cable guide
2. Rubber pad
3. Screws
4. Side cushions
5. Headset cable guide
6. Cable stopper

2. Flip open the metal clasps on the left and right on-ear headphones.

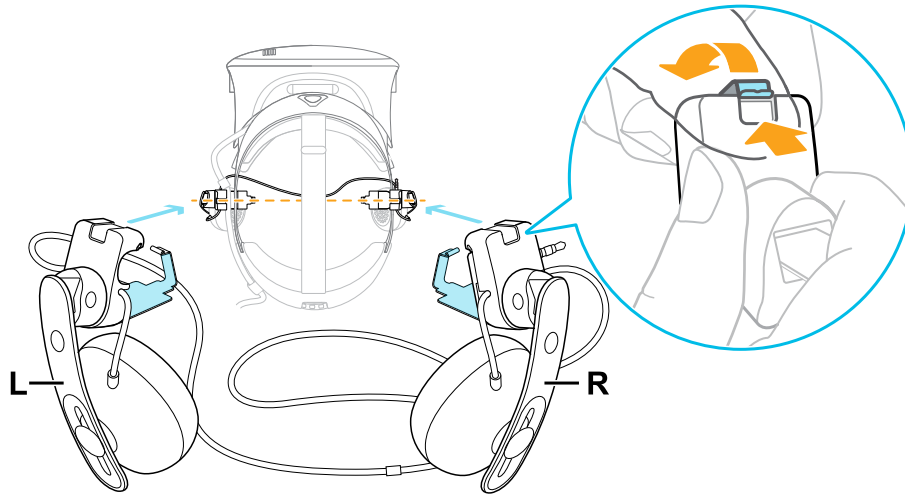

Attaching the right on-ear headphone

Attach the right headphone with the audio plug to the right side of the headset band.

1. Hook the headphone clip over the top of the band.
The screw holes and line marker on the band are helpful guides for positioning the clip.

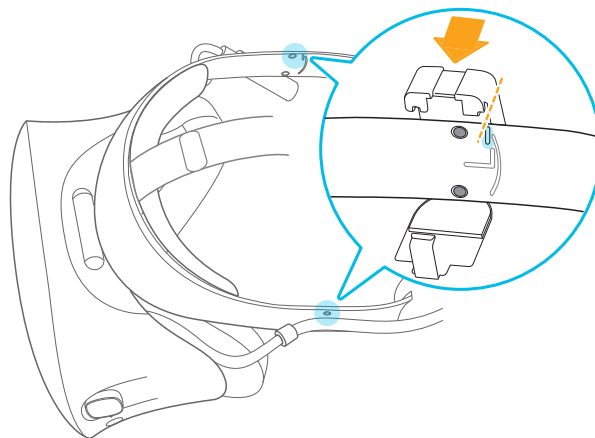

While the clasp is loose, you can reposition the headphone clip for a more comfortable fit. Just make sure that the other clip is similarly placed on its side of the band.

2. Make sure the audio cable is firmly pressed and not falling out of the groove.

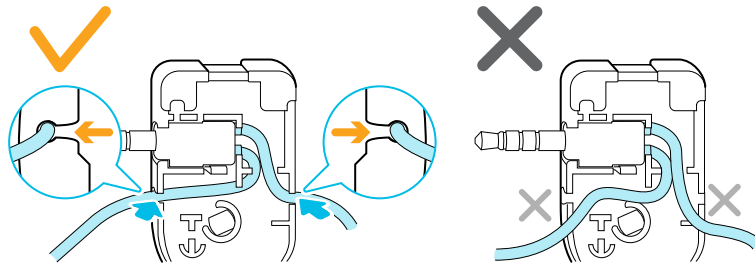

3. Make sure the audio cable runs under the band, and not over the top. Check that it isn't also wedged between the clip and the band.

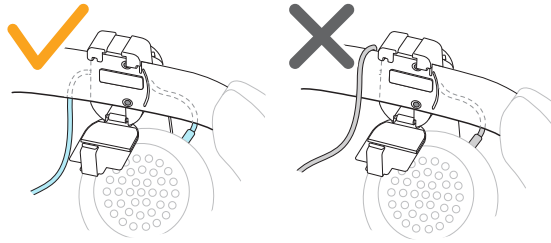

4. Close the clasp around the band, and then snap into place.

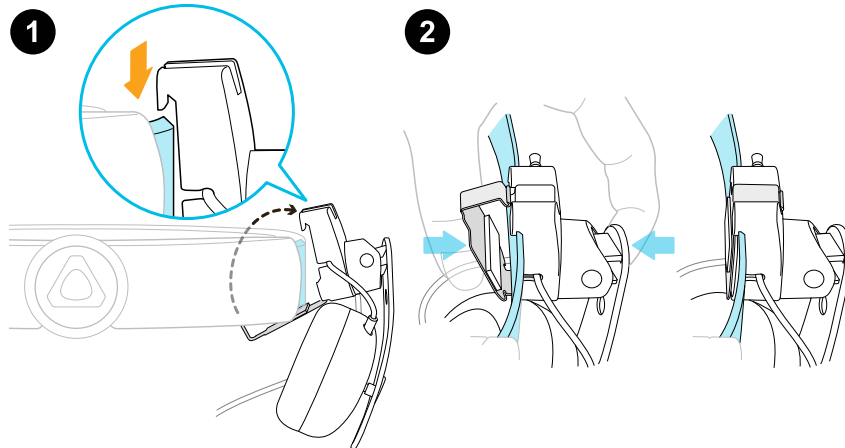

5. Connect the audio cable connector to the headphone plug.

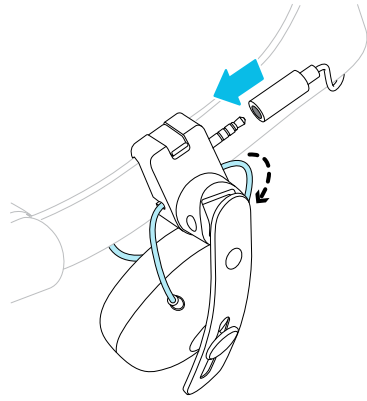

Attaching the left on-ear headphone

Attach the left headphone to the left side of the headset band.

1. Pin the headset cable along the cable guide on the left headphone.
2. Hook the headphone clip over the top of the band.

The screw holes and line marker on the band are helpful guides for positioning the clip.

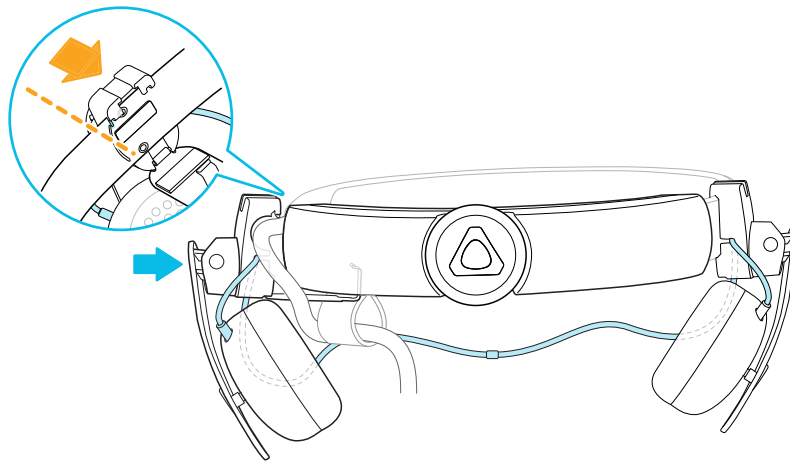

While the clasp is loose, you can reposition the headphone clip for a more comfortable fit. Make sure that the other clip is similarly placed on its side of the band.

3. Make sure the audio cable is firmly pressed in place and not falling out of the groove.

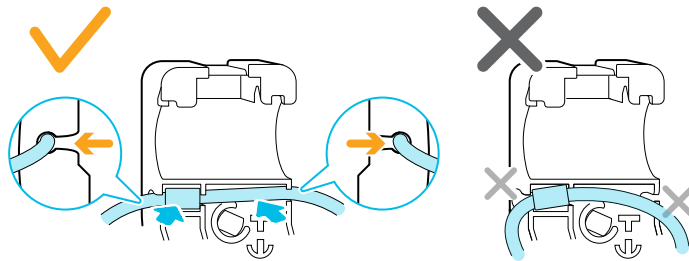

4. Make sure that the stopper on the headset cable isn't caught in the clasp, and is on the visor side to prevent damage to the visor while gaming.

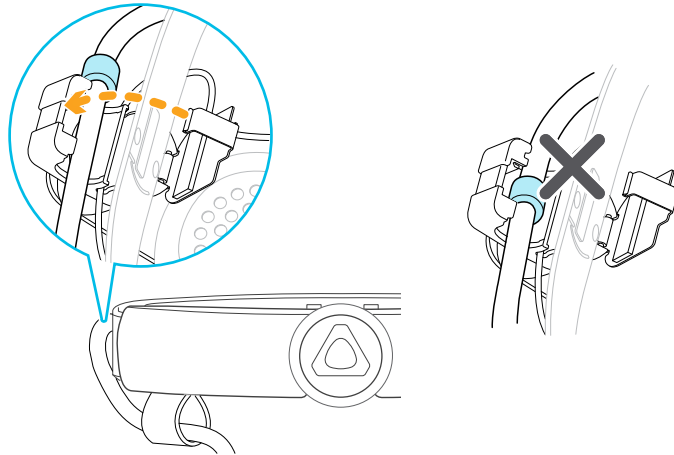

5. Make sure the audio cable runs under the band, and not over the top. Check that it isn't also wedged between the clip and the band.

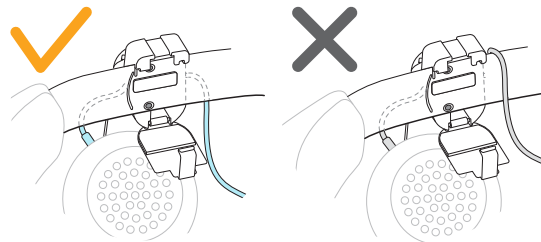

6. Close the clasp around the band and snap into place.

Attaching the headphone audio cable

After the left and right on-ear headphones have been attached, attach the headphone audio cable to the headset band.

1. Remove the front pad from the headset band. For details, see [Removing the front and back pads](#) on page 16.

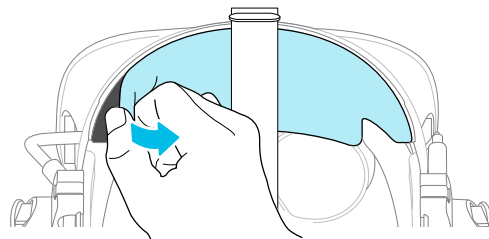

2. On the front section of the band, press the audio cable marker into the slot at the center. Then press the cable along the groove until flush with the band.

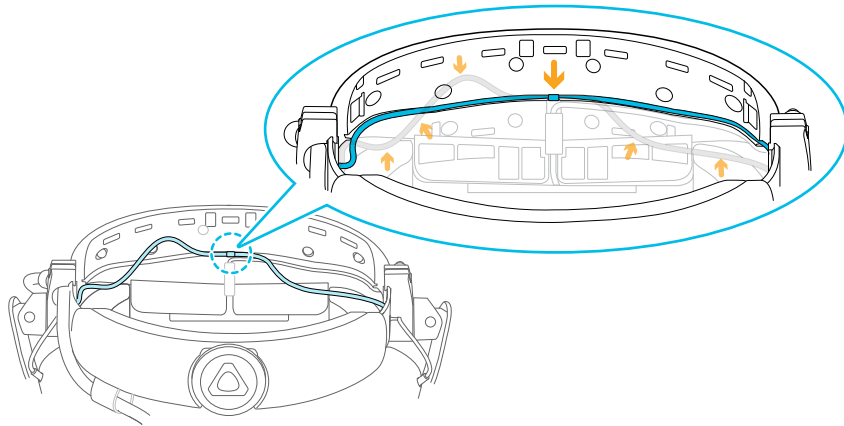

3. Reattach the front pad and side cushions to the headset band. Make sure that the side cushions cover the metal clasps on the band.

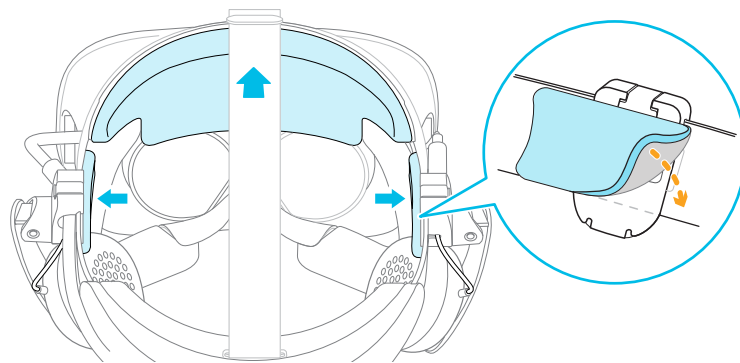

Plugging in your earphones

If you prefer, you can use your own earphones with VIVE Cosmos. To do this, you'll need the replacement kit for earphones. Contact customer care for details on how to order it.

1. Detach the on-ear headphones. For details, see [Detaching the on-ear headphones from the headset band](#) on page 27.
2. Attach the cable guides to the headset band. For details, see [Attaching the cable guides to the headset band](#) on page 34.
3. Insert the earphone plug into the 3.5mm audio cable connector on the right side of the headset band.

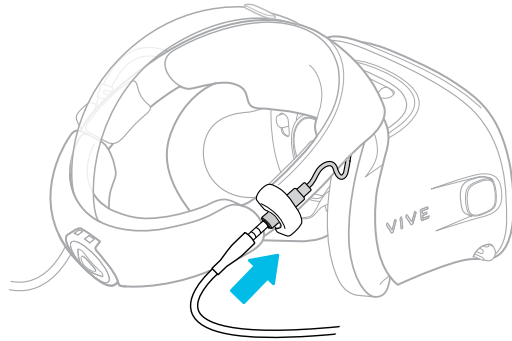

Attaching the cable guides to the headset band



To use your own headphones with VIVE Cosmos, you'll need the replacement kit for headphones. For details on how to get the kit, contact customer care.

Before plugging in your earphones, you need to attach the audio cable guide and headset cable guide to the headset band. The cable guides are included in the replacement kit for earphones.



Before you attach the cable guides, make sure to remove the on-ear headphones from the headset band, including the front pad and side cushions. For details, see [Detaching the on-ear headphones from the headset band](#) on page 27.

Use a cross-shaped screwdriver (PH00) to attach the screws.

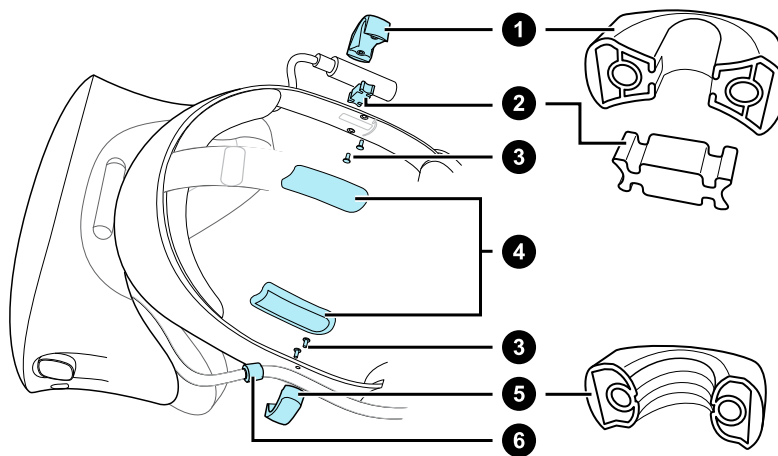

1. Audio cable guide
2. Rubber pad
3. Screws
4. Side cushions
5. Headset cable guide

6. Cable stopper

1. On the right side of the band, place the audio connector between the rubber pad and audio cable guide. Align the holes on the band, rubber pad, and audio cable guide, and then screw in place.
2. On the left side of the band, align the headset cable guide holes with the holes on the band, then screw in place. Make sure that the headset cable passes through the headset cable guide. The stopper on the headset cable must also be placed on the visor side of the cable guide.
3. Reattach the front pad and side cushions to the headset band. Make sure that each side cushion is aligned with the curvature on the band.

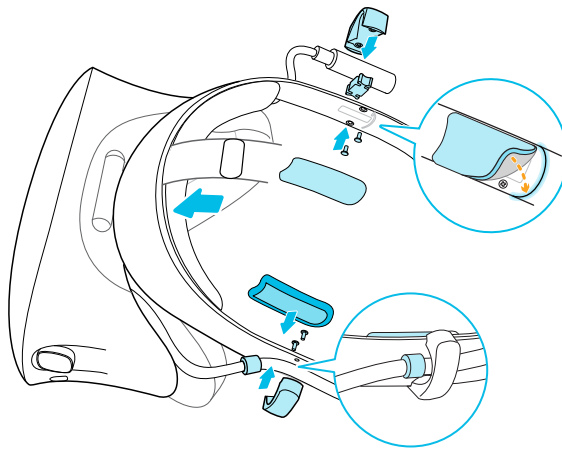

After attaching the cable guides, you can now plug in the earphones. For details, see [Plugging in your earphones](#) on page 33.

Detaching the cable guides from the headset band

If you want to reattach the on-ear headphones, you first need to detach the audio cable guide and headset cable guide from the headset band. The cable guides are included in the replacement kit for earphones. For details on how to order the replacement kit for earphones, contact customer care.

Make sure to keep these parts in a safe place.

Detaching the audio cable guide

You can remove the audio cable guide from the right side of the band.

1. Remove the side cushion.
2. Remove the screws using a cross-shaped screwdriver (PH00).
3. Remove the rubber pad that holds the audio cable connector against the audio cable guide.

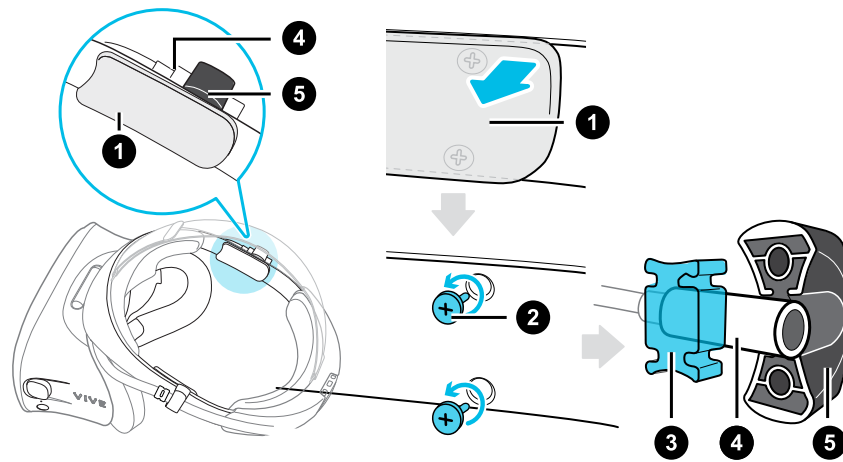

1. Side cushion
2. Screws
3. Rubber pad
4. Audio connector
5. Audio cable guide

Detaching the headset cable guide

You can remove the headset cable guide from the left side of the band

1. Remove the side cushion.
2. Remove the screws using a cross-shaped screwdriver (PH00).
3. Detach the headset cable guide.

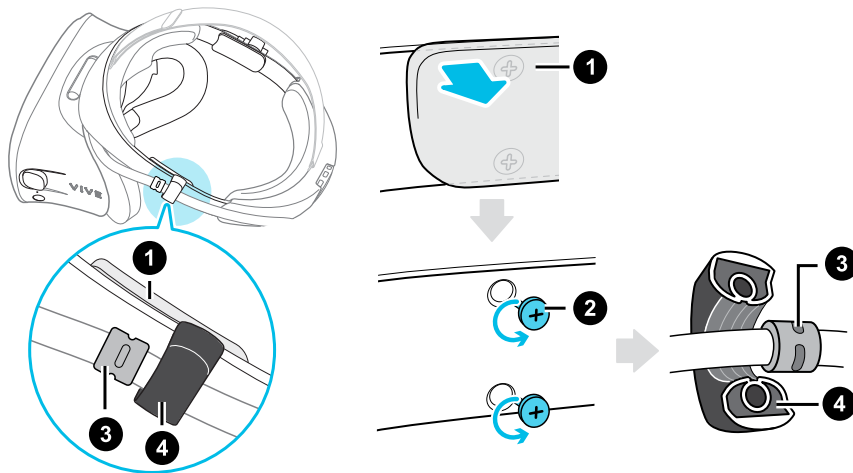

1. Side cushion
2. Screws
3. Cable stopper
4. Headset cable guide

Common solutions

I can't place the on-ear headphones on my ears. What can I do?

You can move the position of the headphones along the headset band so they can be placed on your ears.

Flip open the metal clasp on each headphone and reposition it on the headset band. See [Adjusting the fit of the on-ear headphones](#) on page 25 for more details.



You can also try adjusting the top strap and headset band so that you can position the on-ear headphones properly on your ears. See [Putting on the VIVE Cosmos headset](#) on page 9 for details.

I can't hear anything from the headphones. What can I do?

If there is no sound coming out of the headphones, go through the list below and see if it fixes the problem.

Check the following:

- Make sure the headphones are plugged into the 3.5mm audio cable connector of the headset.
- The volume level is not 0. See [Changing Lens settings](#) on page 57.
- Make sure the USB cable is connected to a USB 3.0 or higher port on your computer. If the USB cable is connected to a lower-speed USB port, move and plug it to a USB 3.0 or higher port. Restart the computer and link box.
- If the USB cable is already connected to a USB 3.0 or higher port on your computer, try switching to a different USB 3.0 or higher port. After switching, restart the computer and link box.

Can I use VIVE Cosmos when SteamVR is in Safe mode?

No, you cannot. Make sure that SteamVR is not running in Safe mode before using VIVE Cosmos.

Link box

About the link box for VIVE Cosmos

Use the link box to connect the headset to your computer.

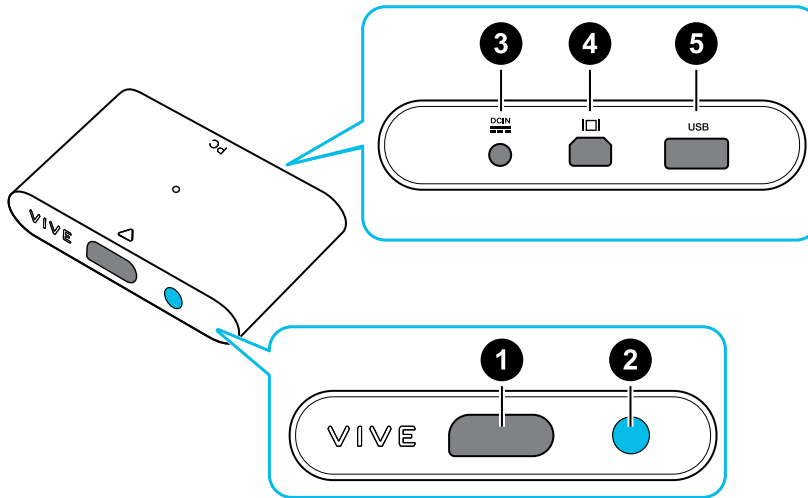

1. Headset cable port
2. Power button
3. Power port
4. DisplayPort port
5. USB 3.0 port

Connecting the headset to your computer via the link box

1. Connect the DisplayPort cable, USB 3.0 cable, and power adapter cable on their corresponding ports on the link box.
2. Plug the power adapter into an electrical outlet.
3. Connect the other end of the USB 3.0 cable on a USB 3.0 port on your computer.
4. Connect the other end of the DisplayPort cable to the DisplayPort port on the graphics card of your computer where the monitor is also connected. Do not connect the DisplayPort cable to ports on the motherboard.
5. Insert the headset cable connector (side with triangle mark up) to the port on the link box with the corresponding triangle mark.

! Make sure the link box is off before inserting the headset cable connector. Inserting the headset cable connector while the link box is on may damage the link box.

6. Press the Power button to turn the link box on.

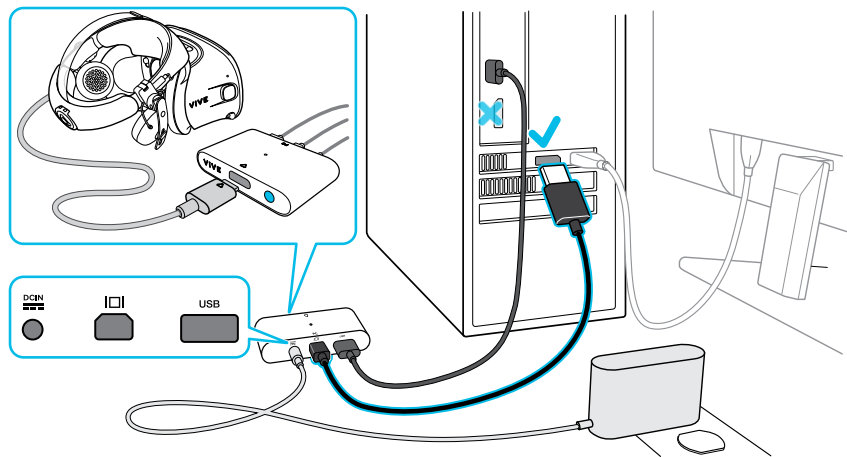

Restarting the link box

If you need to restart the link box, follow these steps.

1. Close the VIVE Console app as well as SteamVR app on your computer.
2. Press the Power button to turn the link box off, and then press the Power button again to turn it back on. On your computer, you might see a notification that drivers are being installed. Wait for the installation to finish.
3. To verify that VIVE™ hardware is detected, restart the VIVE Console app on your computer.

Can I use older versions of the link box with VIVE Cosmos?

Use only the link box as well as the power adapter that came with your VIVE Cosmos. Otherwise, you will encounter hardware compatibility issues. To check if the link box is for VIVE Cosmos, flip over the link box and check if the label is blue.

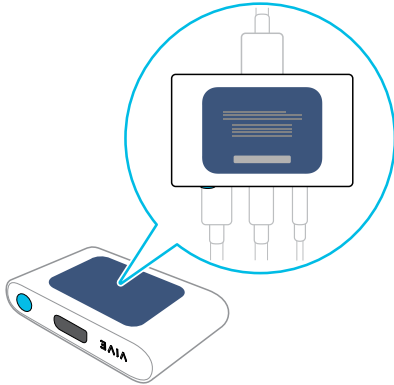

Can I use a laptop with VIVE Cosmos?

As long as your laptop meets the system requirements, you can use it with VIVE Cosmos.

If your laptop does not have a DisplayPort port but has a Mini DisplayPort port instead, you can use a Mini DisplayPort-to-DisplayPort adapter. If you require one, contact HTC customer care.



A Mini DisplayPort-to-DisplayPort adapter may block another port on your laptop.

My computer monitor and headset are turned on but why can't I see anything?

Try the following steps to fix the problem.

1. Disconnect the headset cable from the link box.
2. Restart your computer.
3. Reconnect the headset cable to the link box.

Converter

About the converter for VIVE Cosmos

Use the converter to connect the headset to your computer.



If your VIVE Cosmos originally came with the link box, you can replace the link box with the converter. The converter can be purchased from the Accessories tab on <https://www.vive.com/product/> when it becomes available.

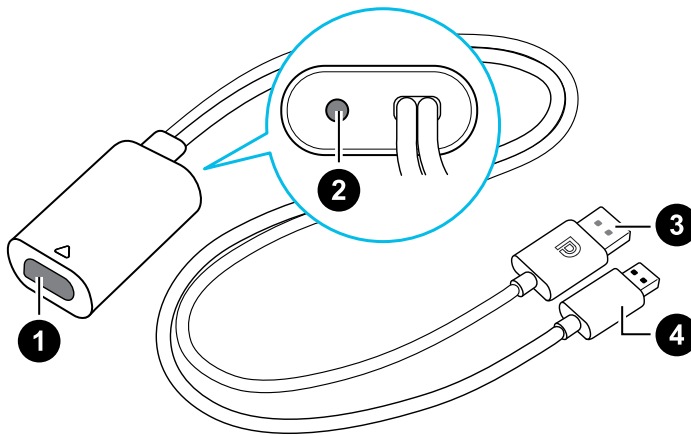

1	Headset cable port
2	Power port
3	DisplayPort cable
4	USB 3.0 cable

Connecting the headset to your computer via the converter



If your VIVE Cosmos originally came with the link box, you can replace the link box with the converter when it becomes available.

1. Connect the power adapter cable to its corresponding port on the converter for VIVE Cosmos.
2. Plug the power adapter into an electrical outlet.
3. Connect the opposite end of the USB 3.0 cable to a USB 3.0 port on your computer.
4. Connect the other end of the DisplayPort cable to the DisplayPort port on the graphics card of your computer where the monitor is also connected. Do not connect the DisplayPort cable to ports on the motherboard.
5. Insert the headset cable connector (side with triangle mark up) to the port on the converter with the corresponding triangle mark.

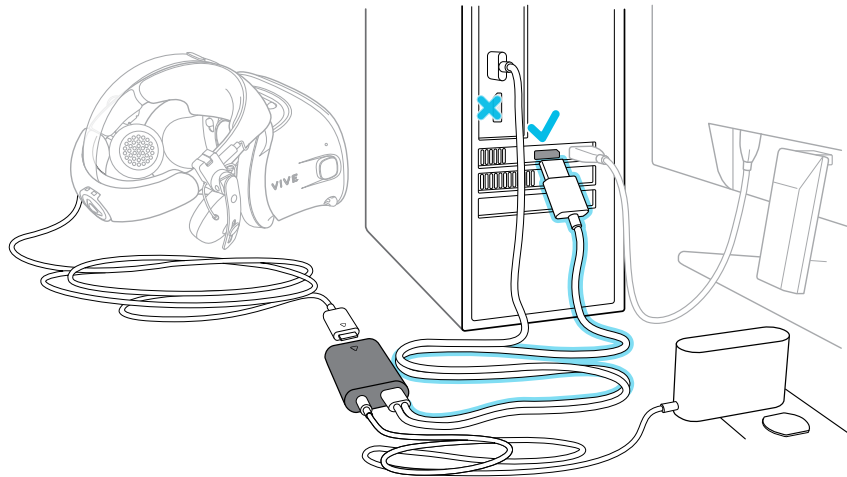

Restarting the converter for VIVE Cosmos

If you need to restart the converter, follow these steps.



If your VIVE Cosmos originally came with the link box, you can replace the link box with the converter when it becomes available.

1. Close the VIVE Console app as well as SteamVR app on your computer.
2. Unplug the power cable from the converter.
3. Wait for a few seconds, and then plug the power cable back in. On your computer, you might see a notification that drivers are being installed. Wait for the installation to finish.

4. To verify that VIVE hardware are detected, restart the VIVE Console app on your computer.

Can I use a laptop with VIVE Cosmos?

As long as your laptop meets the system requirements, you can use it with VIVE Cosmos.

If your laptop does not have a DisplayPort port but has a Mini DisplayPort port instead, you can use a Mini DisplayPort-to-DisplayPort adapter. If you require one, contact HTC customer care.



A Mini DisplayPort-to-DisplayPort adapter may block another port on your laptop.

My computer monitor and headset are turned on but why can't I see anything?

Try the following steps to fix the problem.

1. Disconnect the headset cable from the converter.
2. Restart your computer.
3. Reconnect the headset cable to the converter.

Controllers

About the VIVE Cosmos controllers

Use the controllers to interact with objects in the VR world.

Front view

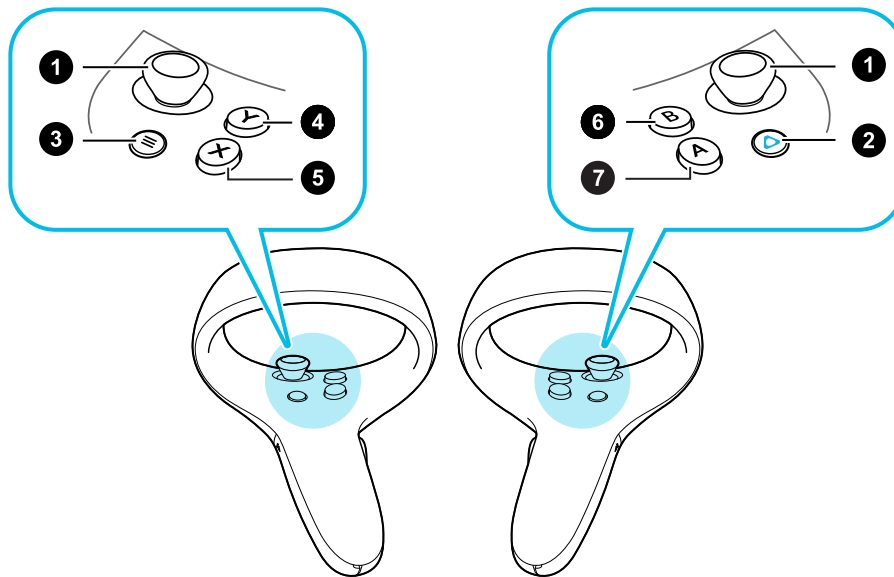

1. Joystick
2. VIVE button
3. MENU button
4. Y button
5. X button
6. B button
7. A button



The MENU button on the left controller appears as a VIVE button when VIVE Cosmos was first released.

Back view

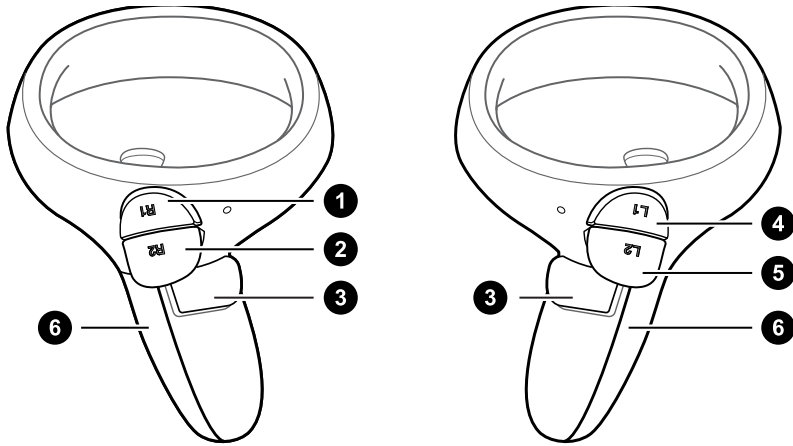

1. Right bumper
2. Right trigger
3. Grip button
4. Left bumper
5. Left trigger
6. Battery cover



When you need to clean the controllers, simply wipe them down using the cleaning cloth provided in the box. Do not use organic solvents or acid-based liquids to clean the controllers.

Inserting the batteries into the controller

Make sure that the included batteries have been inserted into both controllers before turning them on.



It is highly recommended to use AA alkaline or NiMH rechargeable batteries for the controllers.

1. Gently push down on the ▼ icon near the top of the battery cover, then slide and lift to remove it.
2. Insert 2 AA alkaline batteries into the compartment.



- Make sure that the positive and negative ends are facing the correct direction.
- Make sure both batteries are put over the tab in the battery compartment.

3. Replace the battery cover.

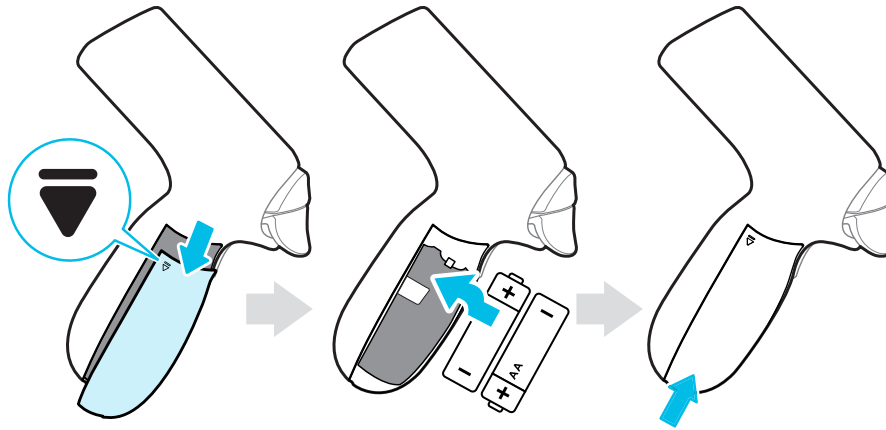

If you're not going to use the controllers for an extended period of time, it's recommended that you take out the batteries.

Removing the batteries from the controller

1. Gently push down on the ▼ icon near the top of the battery cover, then slide and lift to remove it.

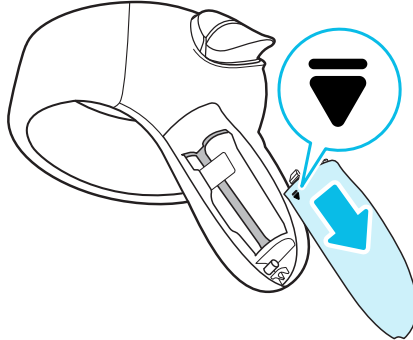

2. Pull the tab in the battery compartment to remove the batteries.

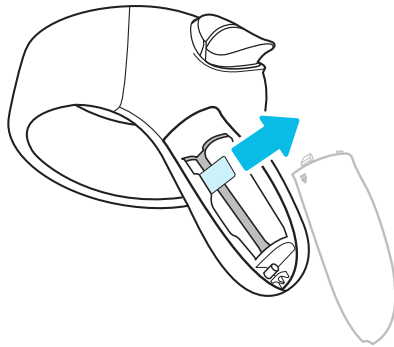

3. Replace the battery cover.

Attaching the lanyards to the controllers

Using the lanyards may help prevent the controllers from accidentally being dropped; however, please do not fling or violently throw the controller as the lanyard may break.

1. Gently push down on the top of the battery cover, then slide and lift to remove it.
2. Insert the lanyard loop on the corresponding hole at the bottom of the controller. Make sure that the loop is hooked around the post.
3. After replacing the battery cover, slide the lanyard over your wrist, and then slide the lock to tighten the lanyard comfortably around your wrist.

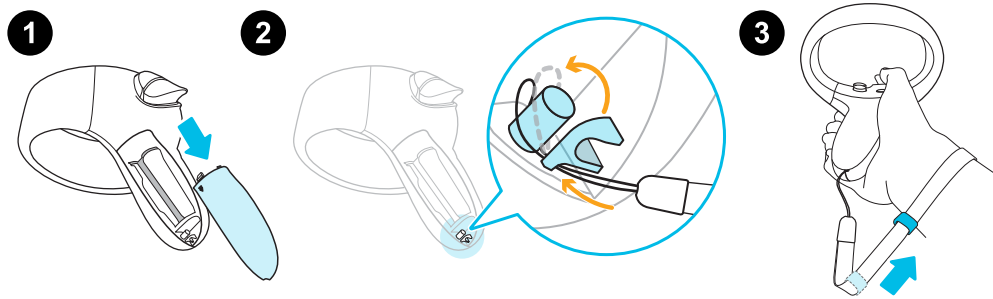

Turning the controllers on or off

Right controller

- To turn the controller on, briefly press the VIVE button.
- To turn the controller off, press and hold the VIVE button for around 3 seconds.

Left controller

- To turn the controller on, briefly press the MENU button.
- To turn the controller off, press and hold the MENU button for around 3 seconds.



The MENU button on the left controller appears as a VIVE button when VIVE Cosmos was first released.

Pairing the controllers with the headset

1. On your computer, open **VIVE Console**.
2. Pair the right controller.
 - a) From VIVE Console, click the right controller icon, and then click **Pair new**.
 - b) Turn on the controller by briefly pressing the VIVE button.
 - c) Press and hold the VIVE and B buttons at the same time then release to start pairing.
 - d) When the pairing is successful, the blinking light turns solid.
3. Pair the left controller.
 - a) From VIVE Console, click the left controller icon, and then click **Pair new**.
 - b) Turn on the controller by briefly pressing the MENU button.
 - c) Press and hold the MENU and Y buttons at the same time then release to start pairing.
 - d) When the pairing is successful, the blinking light turns solid.



The MENU button on the left controller appears as a VIVE button when VIVE Cosmos was first released.

Checking the battery level of the controllers

Check the battery status of the controllers so you know if you need to replace the batteries.



Make sure the controllers are turned on and paired to the headset.

1. From your computer, open the VIVE Console app.
2. Click one of the controller icons. Check under Battery Level to see how much battery power is left for that particular controller.



If you see a red battery icon on the controller icon, this means the remaining battery power is low. It is recommended that you change the batteries.

While in VR, check the controller battery status by pressing the VIVE button on the right controller. This opens Lens and you will see the blue dots on the controller.

Play area

What is the play area?

The play area sets the virtual boundaries of VIVE Cosmos. Your interaction with VR objects happens within the play area.

VIVE Cosmos is designed for room-scale setup, but you can also use it if you have limited space or for stationary experiences.

Planning your play area

Before choosing your setup, make sure that you have enough space.

Room-scale setup needs a minimum play area of 2 m x 1.5 m (6 ft 6 in x 5 ft). Examples of room-scale setup:

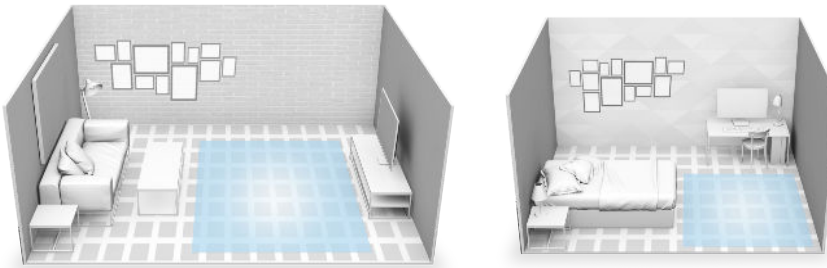

Limited space (stationary experience) do not have space requirements. Examples of limited space (stationary experience) setup:

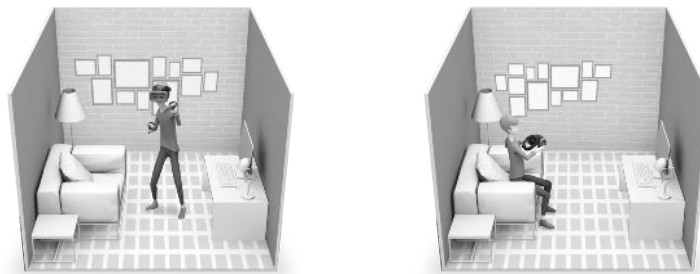

Choosing the play area

Find a space that you will designate as the play area. For best results, do the following:

- Move furniture and obstacles (such as pets, cords, and fragile items) away from the play area.

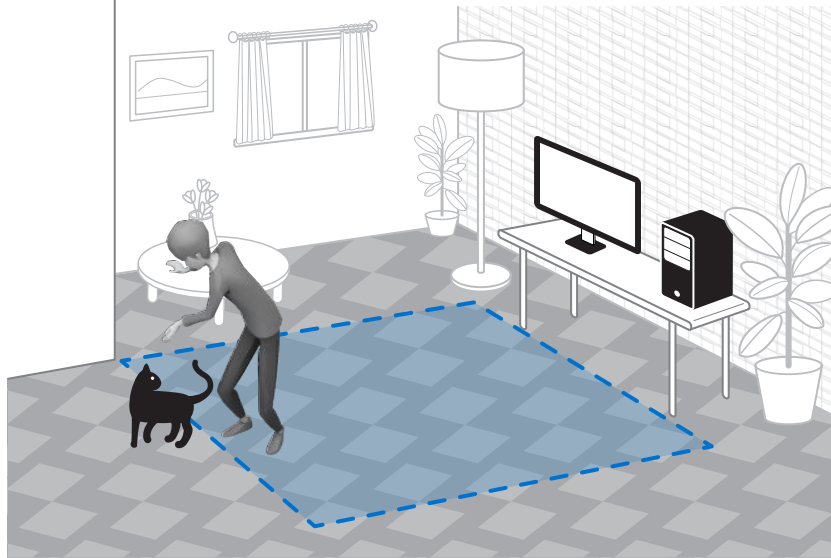

- Keep your play area clean and safe.
- Keep your room bright, but avoid setting up where there are large windows, mirrors, or reflectors.
- Place your computer next to your play area. The headset cable extends around 5 m (16 ft 4 in) from your computer.
- Do not leave your headset in direct sunlight, as it may damage your headset display.
- Avoid an empty room with plain walls. The lack of defining features could affect tracking.

Setting up VIVE Cosmos for the first time

Before you can use VIVE Cosmos, you'll need to complete the setup process, which includes installing VIVE and SteamVR software, setting up the hardware, and using the headset's cameras and sensors to define your play area.

1. To start the setup process, download the setup file on your computer from:
www.vive.com/setup/
2. Run the setup file and follow the prompts to complete the process.



You need to be signed in to your VIVEPORT™ account to complete the setup process.



Once you've completed the room setup, you need to run it again if you transfer your VIVE Cosmos VR system to a different room.

Setting up the play area

Set up a room-scale play area to enjoy an immersive VR experience. Or, you can choose to have a limited space or stationary experience only.

1. From your computer, open the VIVE Console app.
2. Click , and then select **Room Setup**.
3. Follow the on-screen instructions to complete the process.

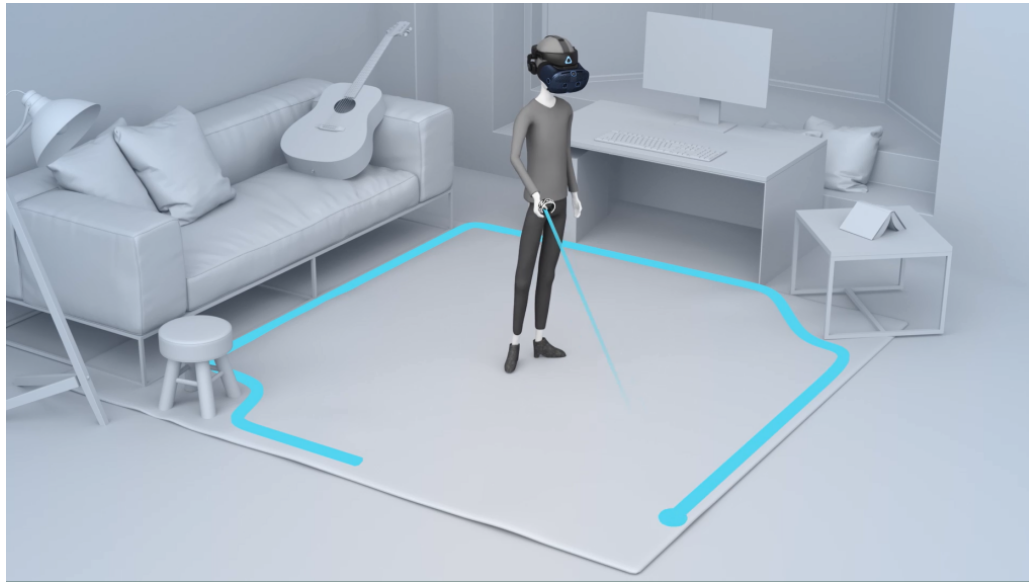

If you only want to have a stationary experience, select **Limited space?** in the step where you're asked to draw your play area boundaries.



When drawing the boundaries of the play area, make sure that the floor is cleared. Do not draw across space occupied by things (such as a table or a chair) since this may cause you to trip into the object while in VR.

Resetting the play area

1. From your computer, open the VIVE Console app.
2. Click , and then select **Room Setup**.
3. Follow the prompts and on-screen instructions to complete the process.

What is the recommended space for the play area?

For room-scale setup, a minimum play area of 2 m x 1.5 m (6 ft 6 in x 5 ft) is required. There's no minimum for limited space (stationary experience).

Can I include space occupied by furniture for the play area?

It is not recommended to do so. When setting the boundaries of the play area, make sure that the floor is cleared. Do not trace across space occupied by things (such as a table or a chair) since this may cause you to trip into the object while in VR.

Does VIVE Cosmos store my room or environment image?

VIVE Cosmos uses its built-in cameras and sensors in order to operate the inside-out tracking function, including establishing boundary displays and viewing the features of your surroundings. The actual image of your environment is not permanently stored on your VIVE Cosmos after displaying it in VR.

Will VR apps that are for limited spaces or stationary experiences only work with a room-scale setup?

Even if you have a room-scale setup, you can still use VR apps that are designed for limited spaces or are stationary experiences. Just make sure that your headset and controllers are tracked within the play area.

How do I resolve download errors during VIVE Setup installation?

Download errors are usually caused by incorrect network settings. For example, due to wrong DNS, the download server address is unresolved by the host. Some network destinations may be

inaccessible, even as connection to other websites seems normal. Please make sure that your network settings are correct, or ask your network administrator for support.

I can't complete the room setup. What should I do?

Check if you're using special characters (such as à or é) in your local Windows user name, which could cause the problem.

As a workaround, you can add a new Windows account using basic Latin alphabet for your user name. After logging in with the new user name, reinstall VIVE Setup and complete the process.

The headset and controllers are not being tracked properly. What can I do?

There are a number of factors that affect how well the headset and controllers are tracked. If the headset and controllers are not being tracked or you feel that they are not being tracked accurately, these are some of the reasons and recommendations on how to fix them:

Room is not bright enough

Adjust the lighting in your room or move your play area to an area where it's brighter.

Strong light source

- Avoid direct glare like spotlights or sunlight on the headset cameras.
- Close the curtains on windows where sunlight shines through, then adjust the lighting in your room.

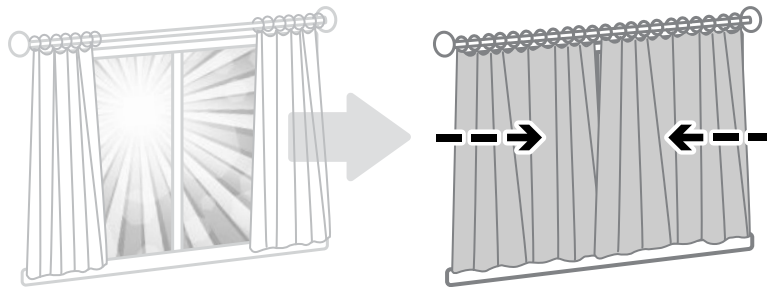

Lack of tracking features in your room

- When setting up VIVE Cosmos for the first time or if you moved your play area, look around your space while wearing the headset to gather information for better tracking accuracy.
- Avoid room with plain walls. If the room has plain walls, attach some sticky notes or hang posters/pictures on the walls to add tracking features.

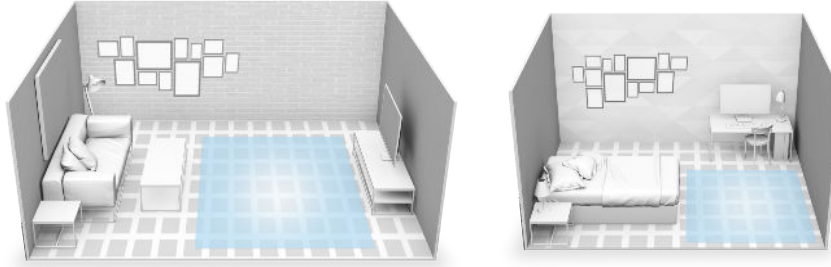

- If you're creating mixed-reality videos, put up a green screen to cover the walls of your room and attach sticky notes on them to add tracking features.

Headset camera are blocked

- Make sure you've removed the transparent films from all the headset cameras. See [About the VIVE Cosmos headset](#) on page 7 to check the locations of the headset cameras.
- Don't cover the headset cameras with stickers. If you have a protective case for the headset, make sure the case doesn't block the cameras.
- Avoid using your hands to support the headset during play, as your hands might accidentally block the cameras. Make sure the headset is snug on your face so it doesn't move during play. See [Putting on the VIVE Cosmos headset](#) on page 9.

Other helpful tips

- Make sure to select the power supply frequency used by your country or region. The power supply frequency affects the headset cameras and tracking accuracy. See [Setting the power supply frequency](#) on page 62.
- If the above recommendations do not improve tracking accuracy, try clearing the environmental information or resetting the system. See [Troubleshooting VIVE Cosmos](#) on page 61.

VIVE Reality System

What is VIVE Reality System?

Our software, reimagined. VIVE Reality System reimagines our core software experience for the age of spatial computing. Discover new content and unify your library in a new user-first home space. Make VR feel less like launching apps and more like stepping between worlds.

What is Lens?

Lens is your starting point in VR—just press the VIVE button on the right controller to bring it up.

From Lens, you can:

- View, sort, and launch titles.
- Browse the VIVEPORT store.
- Go to Origin. To learn more about Origin, see [What is Origin?](#) on page 57.
- View and change system settings such as the default Lens height and distance, boundary color, and system volume.

If Lens is too far or close, you can reposition it in the Lens settings. See [Changing Lens settings](#) on page 57.

Why am I seeing a "Sign In Required" message, what should I do?

You need to be signed in to your VIVEPORT account to use Lens. Go to the computer where VIVE Cosmos is connected to and sign in to your VIVEPORT account.

Launching titles from Lens

Quickly sort, find, and launch titles from Lens.



Sign in to your VIVEPORT account on the computer where VIVE Cosmos is connected to before opening Lens.

1. Press the VIVE button on the right controller to open Lens.
2. Use the joystick to scroll up or down to see recently-used as well as featured titles.
3. To browse your entire collection, select **Go to Library**.





To filter currently installed titles, select an option from the drop-down menus.

4. Select a title, and then select **Play** or **Download** to launch or download the title.

Changing Lens settings

Adjust the audio volume, change the boundary color and transparency, choose a night-time display mode, choose headset camera settings, and more from the Lens settings.

1. Press the VIVE button on the right controller to open Lens.
2. On the right side of Lens, select .
3. Use the joystick to scroll up or down the available settings.
4. Select an option pulling the trigger on a particular setting.
5. After selecting your preferences, select .

What is Origin?

Origin is your own corner of VR.

Explore and treat the virtual space as your home base whenever you're taking a break or switching between titles.



In Origin, you can:

- Explore the virtual space by teleporting.
- Interact with objects.

Launching Origin

1. Press the VIVE button on the right controller to open Lens.
2. On the left side of Lens, select  > **Go to Origin**.



If you go to Origin while in an app, you'll exit that app.

Exploring in Origin

Move around in Origin by teleporting.

1. Use the joystick to aim at the location on the ground where you want to go.
2. Let go of the joystick to teleport to that spot.

Interacting with objects in Origin

Pick up and play with objects in Origin.

1. Touch an object with a controller. The controller will vibrate and the object will be highlighted if you can interact with the object.
2. While still touching the object with a controller, do one of the following:
 - To interact with objects such as pressing a button, pull the trigger.
 - To pick up an object, press and hold the Grip button. To drop the object, release the Grip button.

Settings

Disabling Volume limit

By default, Volume limit is turned on for safety reasons. If you feel that the volume of the plugged headphones or your own headphones is not loud enough for you even with the volume level set high, you can turn this setting off.



Listening at a high volume for a long time may damage your hearing.

1. From your computer, open the VIVE Console app.
2. Click , and then select **Settings** > **Audio**.
3. Click the Volume limit **On/Off** switch to turn the setting off.

Capturing screenshots in VR

Want to show off your high game score? It's easy to take a screenshot of what you're seeing in VR.

Do one of the following:

- On the right controller, press the VIVE button and trigger at the same time.
- On the left controller, press the MENU button and trigger at the same time.



The MENU button on the left controller appears as a VIVE button when VIVE Cosmos was first released.

You'll see a notification when the screenshot is saved.

To find the screenshot on your computer:

- On VIVE Console, click  > **Settings** > **General** > **Open folder**.
- Go to `C:\Users\[user name]\AppData\Roaming\HTC\Vive\Screenshot`.

Seeing real surroundings

See your real surroundings on the headset through the VIVE Cosmos cameras.

1. From your computer, open the VIVE Console app.
2. Click , and then select **Settings** > **Camera**.
3. You can choose to:
 - Show your real surroundings by pressing the VIVE button on the right controller twice.
 - Automatically show real surroundings when you step over the play area boundary.

While in VR, enable or disable the camera settings by going to Lens settings. See [Changing Lens settings](#) on page 57.

Enabling motion compensation

Turning on motion compensation helps keep the frame rate consistently high even if you have less-than-ideal computer specs.

1. From your computer, open the VIVE Console app.
2. Click , and then select **Settings > Video**.
3. Click the Motion compensation **On/Off** switch to enable it.



Some graphic cards may not support motion compensation.

Updating the firmware

Firmware updates may include improved functionality and bug fixes.

1. From your computer, open the VIVE Console app.
2. If a firmware update is detected for any of the VIVE Cosmos hardware, click **Firmware update**. You'll see a list of hardware that has an available firmware update.
3. Click **Update**.
4. Check that the progress is complete. If the controllers have updated, you may need to turn them back on.

Troubleshooting VIVE Cosmos

If you feel that VIVE Cosmos is not running smoothly or if you encounter problems while using it, try the tools in VIVE Console to fix them.

1. From your computer, open the VIVE Console app.
2. Click , and then select **Settings > Troubleshooting**.
3. Depending on the problem, do one of the following:
 - **Clear the environment information** if you have tracking issues while using the headset.
 - **Reset headset and settings** if there is a persistent problem that cannot be solved.



You can also report an issue or send feedback by clicking **Report**.

Joining the VIVE Cosmos beta program

Opting in to the VIVE Cosmos beta program lets you receive preview builds and give feedback.



Beta software may be unstable and not work as intended.

1. From your computer, open the VIVE Console app.
2. Click , and then select **Settings** > **Advanced**.
3. Click the Beta program **On/Off** switch to enable it. When prompted, confirm whether to join the beta program or not.



You can opt-out of the beta program anytime by turning the Beta program switch off.

Setting the power supply frequency

Make sure to choose the power supply frequency used by your country as this affects the headset cameras and tracking accuracy.

1. From your computer, open the VIVE Console app.
2. Click , and then select **Settings** > **Camera**.
3. Under Power supply frequency, select the power supply frequency used by your country.

What do the error codes and messages mean? What can I do?

Check the error code associated with the issue, and then try to resolve the error with the suggested steps.

Error code	Issue	Steps to resolve issue
001	Headset is not connected.	<ul style="list-style-type: none"> ▪ Check that the headset is properly connected to your computer. ▪ Use a different USB port on your computer. ▪ If the issue persists, restart your computer.
002	VIVE Console needs to be restarted.	<ol style="list-style-type: none"> 1. Close VIVE Console. 2. Open Task Manager. 3. Find and select <code>HID_Manager_Server.exe</code>. 4. Click End task. 5. Restart VIVE Console.

Error code	Issue	Steps to resolve issue
003	DisplayPort cable is disconnected or no video stream detected.	<ol style="list-style-type: none"> 1. Make sure the DisplayPort cable is plugged in to the link box or converter and computer. 2. On your computer, go to Control Panel > System and Security > System. 3. Click Device Manager, and then click to expand the list under Universal Serial Bus controllers. 4. Right-click Generic USB Hub (there may be more than one with the same label), and then select Properties. 5. Click the Power Management tab, and then de-select Allow the computer to turn off this device to save power. 6. Restart the link box or converter. 7. Restart VIVE Console. <p>If the issue persists, try updating your GPU driver to the latest version.</p>
005	Make sure front cover is firmly attached to the headset.	Make sure front cover is firmly attached to the headset.
006	DisplayPort connection is not stable.	<ul style="list-style-type: none"> ▪ Try restarting the headset. ▪ Try another DisplayPort port on your computer. ▪ Check if your graphics card supports DisplayPort.
007, 008	ROM checksum failed. Try again after updating the software.	<ol style="list-style-type: none"> 1. Follow the steps to re-download and update the software. 2. Run the firmware update again.

Error code	Issue	Steps to resolve issue
009	The USB cable must be connected to a USB 3.0 or higher port on the computer.	<ol style="list-style-type: none"> 1. Make sure the USB cable is connected to a USB 3.0 or higher port on the computer. 2. If the USB cable is already connected to a USB 3.0 or higher port on the computer, try switching to a different USB 3.0 or higher port. 3. If the issue persists, on your computer, go to Control Panel > System and Security > System. 4. Click Device Manager, and then click to expand the list under Universal Serial Bus controllers. 5. Right-click Generic USB Hub (there may be more than one with the same label), and then select Properties. 6. Click the Power Management tab, and then de-select Allow the computer to turn off this device to save power. 7. Restart the link box or converter. 8. Restart VIVE Console.
010	No audio coming from the headset.	<ol style="list-style-type: none"> 1. In the Windows audio settings, adjust the volume level and make sure the volume is not muted. 2. If the issue persists, in the Windows task tray, right-click the volume icon > Sounds. In the Playback tab, right-click VIVE Cosmos > Set as Default Device. 3. If the issue persists, in the Playback tab, right-click Speaker VIVE Cosmos Multimedia Audio > Set as Default Device. 4. If the issue persists, restart the link box or converter. 5. If the issue persists, plug the USB cable into a different USB 3.0 port on your computer. 6. If the issue persists, manually update the USB driver on your computer. You can also download and install official driver updates from the website of your motherboard or USB port manufacturer. 7. If the issue persists, restart your computer. 8. If updating your USB driver doesn't solve the issue, purchase and use another PCI-Express USB card (with Intel chipset).

Error code	Issue	Steps to resolve issue
100	USB hub update failed.	<ol style="list-style-type: none"> 1. From your computer, open the Device Manager. 2. Under Universal Serial Bus controllers, find and right-click Generic USB Hub, and then select Properties. 3. Click the Details tab, and then select Hardware IDs from the drop-down list. 4. Under Values, find the following nodes: <ul style="list-style-type: none"> ▪ VID: 0BB4, PID: 0315 ▪ VID: 0BB4, PID: 0323 5. Click the Power Management tab, and then de-select Allow the computer to turn off this device to save power option. 6. Restart your computer as well as the link box or converter. 7. Retry the firmware update.
101	Audio update failed.	<ol style="list-style-type: none"> 1. Restart your computer as well as the link box or converter. 2. Retry the firmware update.
102, 106, 107, 108	Headset firmware update failed.	<ol style="list-style-type: none"> 1. Restart your computer as well as the link box or converter. 2. Retry the firmware update.
103	Controller firmware update failed.	<ol style="list-style-type: none"> 1. Restart your computer as well as the link box or converter. 2. Retry the firmware update.
105	Headset not connected.	<ol style="list-style-type: none"> 1. Restart your computer as well as the link box or converter. 2. Retry the firmware update.
109, 110, 111, 112	Camera firmware update failed.	<ol style="list-style-type: none"> 1. Restart your computer as well as the link box or converter. 2. Retry the firmware update.
200	The headset cannot be detected. Make sure that cables are properly connected and then restart the headset.	Make sure the cables between the headset, link box or converter, and computer are all properly connected and then restart the headset.

Error code	Issue	Steps to resolve issue
201	The headset display cannot be detected. Make sure that the headset cable is properly connected.	Make sure the headset cable is properly connected.
202	Calibration data is lost. For assistance on how to fix this, contact customer care.	Contact customer care.
203, 205, 206, 207	Oops! This should not happen. Re-install VIVE software to fix this.	Re-install the VIVE software.
208	Update VIVE software and firmware to fix this.	Update both the VIVE software and firmware.
209	The server is disconnected. Restart VIVE Console to fix this.	<ol style="list-style-type: none"> 1. Restart VIVE Console. 2. If the issue persists, restart your computer.
210	The compositor is disconnected. Restart VIVE Console to fix this.	Restart VIVE Console.
211	Check that your GPU driver is updated to the latest version.	Make sure your GPU driver is updated to the latest version.
212, 213, 214	Restart VIVE Console to fix this [error ID number].	Restart VIVE Console.
215	Please update graphics card driver.	Update your graphics card driver to the latest version.
216	Please check that SteamVR was installed properly or has finished updating.	Make sure SteamVR was installed properly or has finished updating.
217	SteamVR has encountered an unexpected problem. Restart VIVE Console to fix this.	Restart VIVE Console.

Error code	Issue	Steps to resolve issue
218	The VIVE Cosmos camera is being used by another application.	<ol style="list-style-type: none"> 1. In Windows' Privacy settings > Camera, make sure Allow apps to access your camera is enabled. Then, restart VIVE Console. 2. If the issue persists, check if the VIVE Cosmos camera is occupied by another Windows application. If yes, close the application using the camera, and then restart VIVE Console. 3. If the issue persists, restart your headset. 4. If the issue persists, use a different USB 3.0 port on your computer. Then, restart VIVE Console.
219	The VIVE Cosmos headset can't be recognized when SteamVR is in safe mode.	Disable SteamVR safe mode, and restart SteamVR.
220	There is a compatibility problem with the DisplayPort connection (HDCP error)	<p>If you're using an MSI notebook, go to MSI's technical support web page for help on how to update your notebook to the latest V-BIOS.</p> <p>If you're not using an MSI notebook, submit a report using VIVE Console. In VIVE Console, go to Settings > Troubleshooting > Report issue.</p>
221	The front cover has been changed. Restart VIVE Console to fix this.	Restart VIVE Console.

Trademarks and copyrights

©2019 HTC Corporation. All Rights Reserved.

VIVE, the VIVE logo, VIVEPORT, the VIVEPORT logo, HTC, the HTC logo, and all other HTC product and service names are trademarks and/or registered trademarks of HTC Corporation and its affiliates in the U.S. and other countries.

Steam, the Steam logo and SteamVR are trademarks and/or registered trademarks of Valve Corporation in the U.S. and/or other countries.

All other trademarks and service marks mentioned herein, including company names, product names, service names and logos, are the property of their respective owners and their use herein does not indicate an affiliation with, association with, or endorsement of or by HTC Corporation. Not all marks listed necessarily appear in this User Guide.

Screen images contained herein are simulated. HTC shall not be liable for technical or editorial errors or omissions contained herein, nor for incidental or consequential damages resulting from furnishing this material. The information is provided “as is” without warranty of any kind and is subject to change without notice. HTC also reserves the right to revise the content of this document at any time without prior notice.

No part of this document may be reproduced or transmitted in any form or by any means, electronic or mechanical, including photocopying, recording or storing in a retrieval system, or translated into any language in any form without prior written permission of HTC.

Index

B

Beta program *62*

C

Cable guides

- attaching *34*
- detaching *35*

Camera pass-through *60*

Capturing screenshots *59*

Controllers

- about *44*
- battery level *49*
- inserting the batteries *46*
- pairing with the headset *49*
- turning on or off *48*

Converter

- about *41*
 - connecting the headset *42*
 - restarting the converter *42*
-

D

Disabling volume limit *59*

F

Firmware updates *61*

H

Headset

- about *7*
 - adjusting the IPD *12*
 - cleaning the lenses *21*
 - connecting a USB device *14*
 - front cover *24*
 - putting on *9*
 - replacing the face cushion *15*
 - status lights *25*
-

L

Lens

- about *56*
- launching titles *57*
- settings *57*

Link box

- about *38*
 - connecting the headset *39*
-

M

Motion compensation *61*

O

On-ear headphones

- adjusting *25*
- attaching *29, 31*
- detaching *27*

Origin

- about *57*
 - interacting with objects *58*
 - launching *58*
 - moving *58*
-

P

Play area

- about *50*
 - choosing *51*
 - setting up *50*
-

S

Seeing real surroundings *60*

Setting the power supply frequency *62*

T

Troubleshooting VIVE Cosmos *61*

V

VIVE Console

- beta program *62*
- Firmware update *61*
- motion compensation *61*
- screenshots *59*
- see real surroundings *60*
- Setting the power supply frequency *62*
- troubleshooting *61*
- volume limit *59*

VIVE Reality System *56*