

# User Manual

## In-Dash Car Stereo System

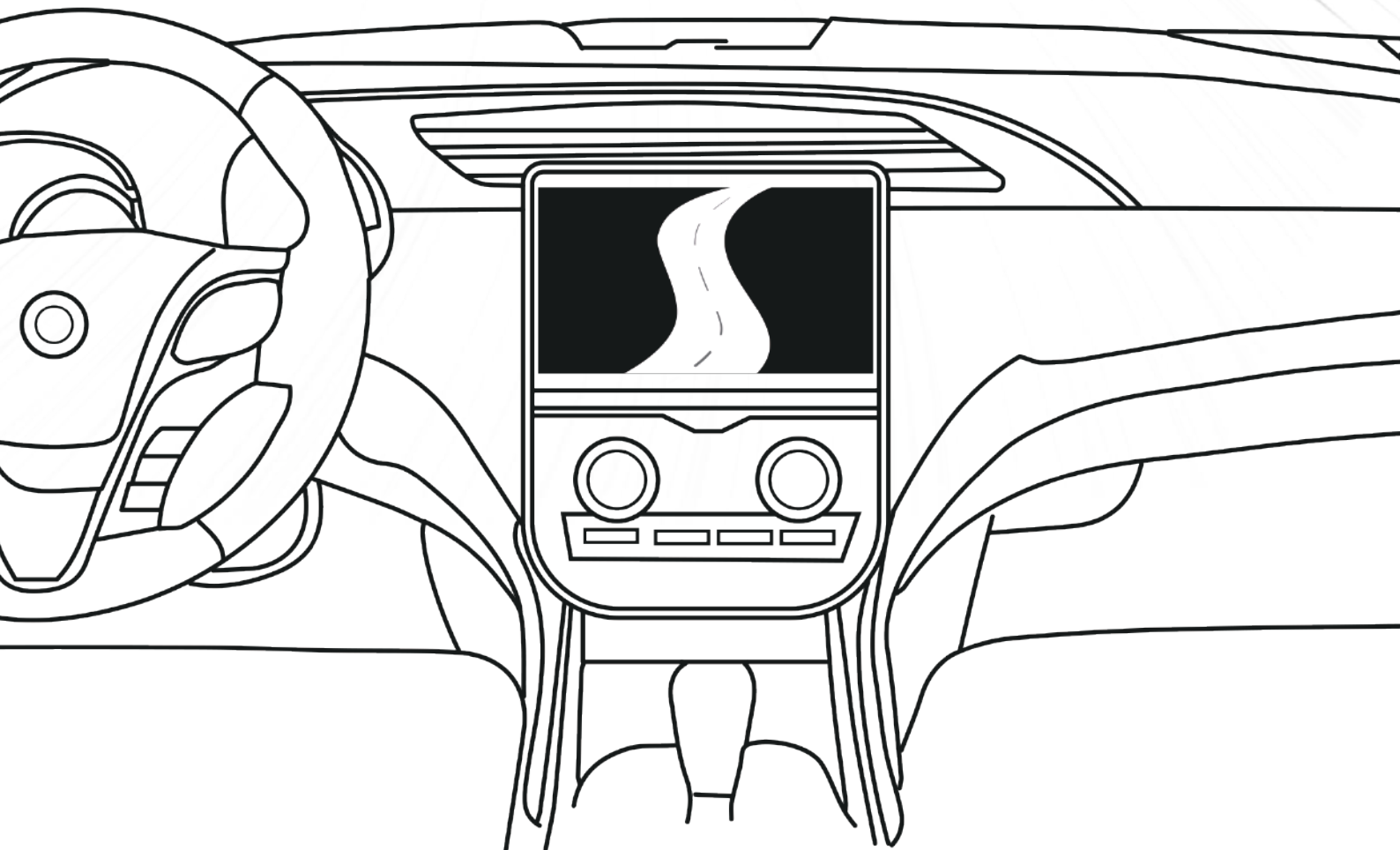

# FOREWORD

---

## **Thank you for choosing the android car audio navigation system of this company!**

When you use this product, please read all the information attached with it. This manual is introduced all the functions of audio-visual navigation system, so that you can obtain information about products introduction and operation methods, make sure the operation is more convenient.

The display picture as example of manual referenced may has a little difference from the actual picture.

The display contents of this manual may be a little different with the actual content.

When products continue to update and upgrade their functions, any parameters will be added / changed to make without notice. Any problem please check the details with the agent, thanks for your support and cooperation!

### **NOTE:**

The information of this manual protected by copyright. Any part of it without company prior written permission is not permitted in any way to copy and photocopy.

The company reserves the final explanation about three guarantees warranty and relative information in this manual.

# WARNING

---

## **Warning**

In order to avoid accidents, a possible violation of applicable law, do not use other function as purposes expect navigation when driving.

In some areas, it is illegal for the drivers or other people in car to watch the images of the display.

## Notice for safety items

In order to avoid any d injury or property damage of the user or other persons, please be sure to read in details and abide the following notice item.

- 1) Read the Manual.
- 2) Take good care of the Manual for future use.
- 3) To comply with all the warning and notice of this manual.
- 4) To comply with all operating instructions.
- 5) Regarding the power supply, please refer what the manual stated.
- 6) The installation and wiring distribution of this product need specialized skills and experience. To ensure safety, commissioned by professional technicians for installation and wiring.
- 7) There are not any parts attached with the products for user to repair and replace, please ask the professional technician with qualification of maintenance to repair and replace.
- 8) Ventilation: Do not plug any ventilation cooling vents, the local shell holes and other openings are for ventilation of heat. In order to ensure machine works stable and reliable, long service life, not to plug the hole cooling, ventilation environment must be maintained to avoid overheating the machine caused by smoking, fire or other danger.

# WARNING

---

- 9) Avoid heat source: heat source should be avoided and products will be not installed on local exposure to direct sunlight, high temperature areas; to be away from heat sources, such as heating, heaters, heat or have other things (including magnifier).
- 10) Avoid Water or Moist: device should avoid water or moist, do not let this machine be exposed to rain or moisture in the environment (as when rain and car washing) to avoid the internal machinery of the short circuit caused the fire, electric shock or other danger.
- 11) Cleaning: before cleaning machines have to shut down power, and then wipe panel. Do not use volatile chemicals (such as gasoline or thinner) to clean panel.
- 12) Avoid the matter or water into the device. to prevent foreign matter or liquid into the inside of the machine, do not insert the foreign body from the cooling hole or other opening into the machine. If you insert foreign bodies, it may cause electric shock, machine parts within a short circuit caused the fire, such as the risk of electric shock.
- 13) Installation device: Do not install the unit to the truck, frame, tripod, bracket or table without the manufacturer's recommendations, should be installed on the install fittings which come with machines. When used in the car, pay more attention to firm the installation of this machine, avoid the machine falling down because of the sudden brake and resulting in personal injury.
- 14) Don't operate the machine in the event of rain or lightning for a long time, have to cut off the machine power.
- 15) Appear in the following situations, please turn off the local power supply in time, and contact with professional technician.
  - A. When the power wire or connector damaged.
  - B. When the machines were splashed with liquid or when the entry of foreign matter.
  - C. When the machine has been rained or moisture attack:

# WARNING

---

D. When the machine crashed from a height or as a result of abnormal operation or unreasonable damage caused.

16) LCD Display: do not let the machine decline to avoid LCD screen fragmentation, if so, when the outflow of liquid crystal, do not touch the liquid crystal, so as not to be harmed. Do not heat the liquid crystal display or scratch LCD with sharp objects, touch panel is also susceptible to be scratched. The effective pixel of LCD screen is more than 99.99 percent, but 0.01 percent of the pixels could not be lightened normally.

## Notice before Installation

Products of the manufacturers recommend that you do not install or repair their navigation systems by yourself. Installation and maintenance of the product may cause you in danger of electric shock or others, for all installation and maintenance operations of this navigation system. Please entrust to the service center authorized by manufacturer.

Forbid to use the following dangerous installing ways and location:

1. When the car in a sudden stop may cause injury on the driver and passengers.
2. To avoid the possibility that impeded the operation of the vehicle drivers, such as the driver front seat or the floor near the steering wheel, stick shift.

Before opening the hole from faceplate in the dashboard panel, make sure that the rear space is enough. Be careful, not to damage the fuel cable, brake cable, electrical components, power lines or cable communications.

When use the screws, please ensure that they are not contact with any electrification down-lead. Vibration may have damaged wire or insulation skin and lead to a short circuit or other damage to the vehicle.

In order to ensure proper installation, use the standard method of installation of the required components. If you use any non-standard components. This product can be internal damaged or loose components, leading to damage of the product. If the GPS antenna may lead to the winding column or stick shift that would

# WARNING

---

## System installation

### Voltage rating (as the picture)

- 1) This product use for the vehicle with 12V battery and negative GND. Before the installation, check the battery voltage.
- 2) In order to avoid short-circuit system, installed prior to the proposed removal of the battery negative.
- 3) Don't cross the fuse of the device, directly connect to the battery.

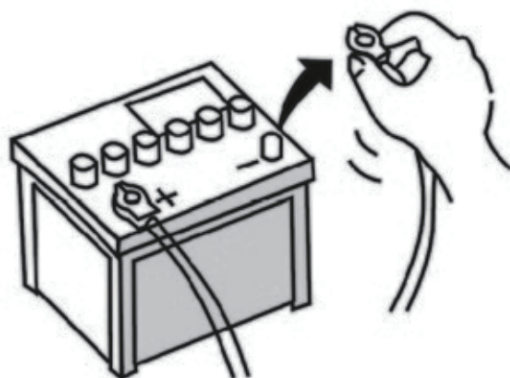

## The installation of the device

- 1) First of all, take the original vehicle CD player out.
- 2) Remove the install bracket and screws and keep it.
- 3) Fix the bracket through the screws on the navigation system device.
- 4) Don't connect this product power wire directly to other power-line circuits.
- 5) Fix all the cables according to the hose diagram.
- 6) Install the navigation system in right position and then screw the bracket of the original car to fix well.

**! Note: Do not damage or dirty the Dashboard.**

# CONTENTS

---

<b>FOREWORD</b>	1	Volume	25
<b>WARNING</b>	2	Sound	25
<b>CONTENTS</b>	6	Video	26
<b>SPECIFICATION</b>	7	Navigation	26
<b>FRONT PANEL</b>	8	Bluetooth	26
<b>FUNCTIONS APPLICATION</b>	9	SWC	26
Radio	10	<b>About Device</b>	26
Phone	11	Factory Setup	27
BT Music	12	Radio	27
Audio Music	12	CAN Type	27
Video	13	Mcu Update	27
Picture	13	Volume	27
AutoLink	14	Menu Icon	27
DSP	16	Touch Study	28
ApkInstaller	18	Display	28
AV_IN	18	ATV	28
Contacts	18	Erase All Content	28
Voice Search	19	Key	28
GPS	21	Default Language	28
Google Play	22	Boot Logo	29
<b>SETTINGS</b>	23	Others	29
<b>General Setting</b>	23	MP mode	29
Network & internet	23	Backcar Setup	29
Car Infotainment	23	Car Info	29
Apps & notifications	23	<b>INSTALLATION OF GPS ANTENNA</b>	31
Storage	23	<b>DIAGRAM</b>	32
Memory	24	<b>REAR VIEW CAMERA</b>	
Car Infotainment	24	<b>CONNECTION</b>	33
Google	24	<b>FRONT VIEW CAMERA</b>	
About device	24	<b>CONNECTION</b>	34
System	24	<b>FREQUENTLY</b>	35
<b>Car Setting</b>	25	<b>ASKED QUESTIONS</b>	
Common	25	<b>TROUBLE SHOOTING</b>	37
Display	25		

# SPECIFICATION

## Product Parameter



comparison diagram of F10 and F10 Pro

Version	F10	F10 PRO
OS	Android 10	Android 10
CPU&Core	MTK 8259 8 core	<b>MTK 8667 8 core</b>
RAM+ROM	4G+64G	<b>8G+128G</b>
Amplifier Chip	TDA7851	TDA7851
Voice Control	/	<b>Support</b>
BT 5.0	Support	Support
4G internet	Support	Support
Built-in Carplay	Support(Wired)	<b>Support(Wireless)</b>
Android Auto	Support(Wired)	Support(Wired)
Resolution	1280*720	1280*720+QLED
DSP	32EQ	32EQ
AHD Camera	Support	Support

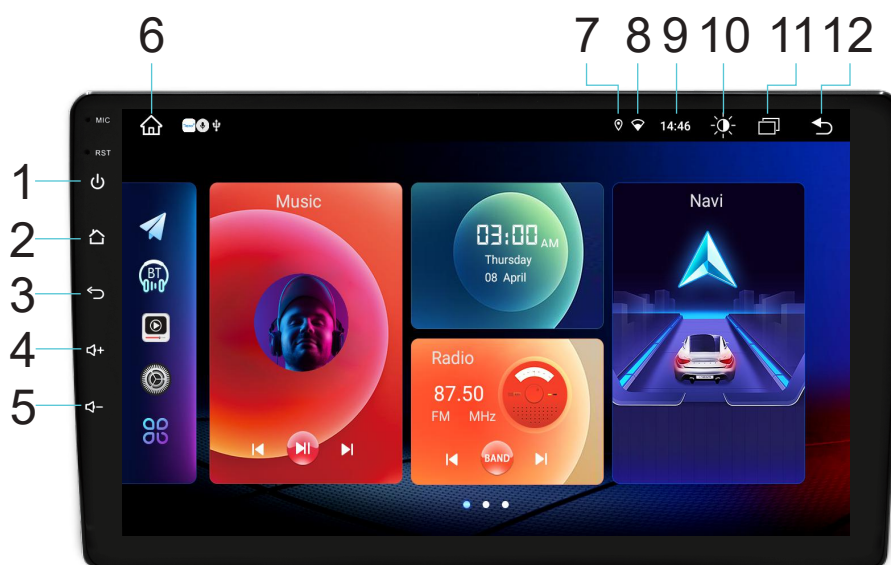
# FRONT PANEL









## FUNCTION

-  **1. Power**
-  **2. Home**
-  **3. Back**
-  **4. Volume**
-  **5. Volume**

## OPERATIONS & CONTROLS

- Short press to mute/cancel mute.  
Long press to enter/quit standby mode.
- Press to enter main menu.
- Return to previous Mode
- Short press to increase volume.
- Short press to decrease volume.

## APPBAR

- |                                                                                                   |                                                                                                                                             |
|---------------------------------------------------------------------------------------------------|---------------------------------------------------------------------------------------------------------------------------------------------|
|  6. Home       |  10. Screen On/off                                       |
|  7. GPS Status |  11. Task Manager(short click)/Split Screen (long press) |
|  8. Wifi       |  12. Back                                                |
|  14:46 9. Time |                                                                                                                                             |

# FRONT PANEL

## MAIN MENU

Please refer to the actual menu display for reference

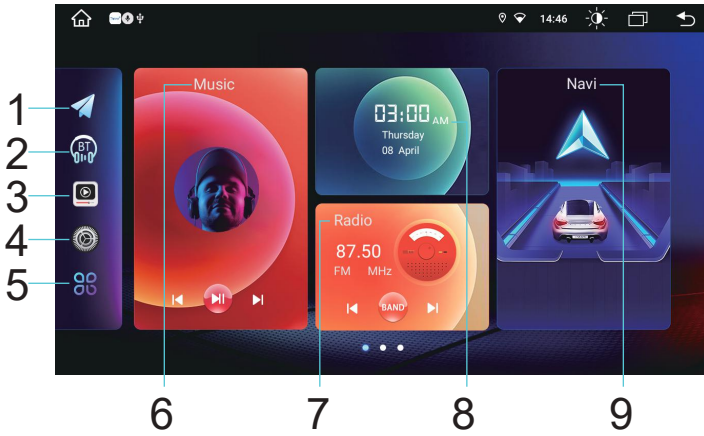

## ACCESS FAST SETTINGS

Slid down from the top of the display you can access the fast settings

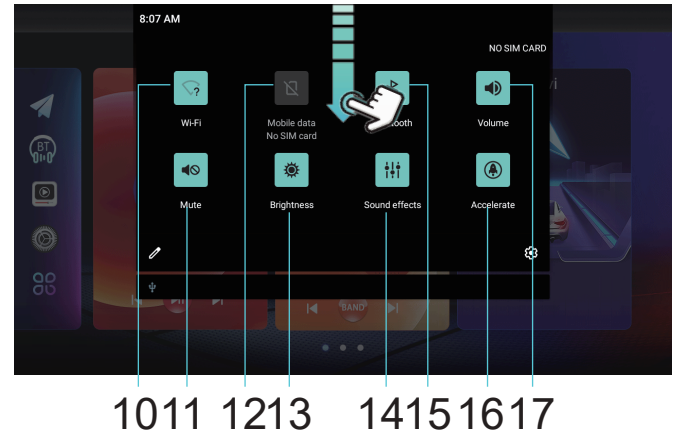

**1 Navi**



**2 BT Music**



**3 Video**



**4 Setting**



**5 Apps**



**6 Music**



**7 Radio**



**8 Date & time**

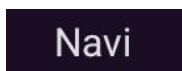

**9 Navi**



**10 Wi-Fi**



**11 Mute**



**12 Mobile data No SIM card**



**13 Brightness**



**14 Sound effects**



**15 Bluetooth**



**16 Accelerate**





**17 Volume**

# FUNCTIONS APPLICATION

## Radio

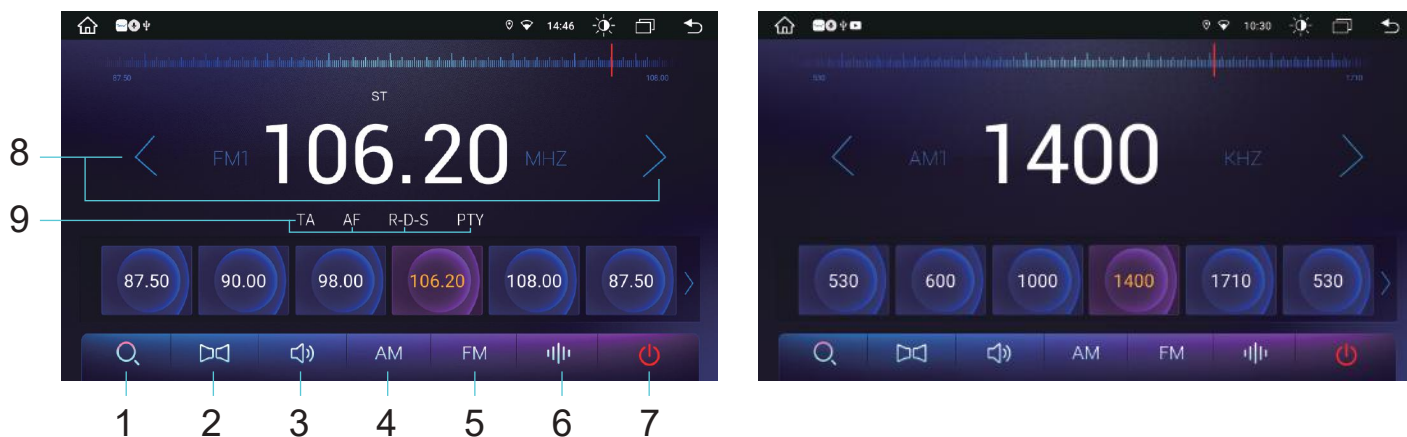
Touch "Radio" in main menu to enter radio interface.



 **1 SCAN :** Scans for available stations, long press to automatically search and save stations with the strongest signals into the presets.

 **2 Stereo**

 **3 Volume**

 **4 AM :** Switch between AM1/AM2

 **5 FM :** Switch between FM1/FM2/FM3

 **6 EQ :** Enter the EQ interface

 **7 Exit:** Exit Radio

 **9 Track: Next/Previous**

 **10 RDS Search :**

RDS is a special radio system develop by BBC, Which only could be used on Europe area, Press PTY AF List of alternative Frequencies TA Traffic Announcement

# FUNCTIONS APPLICATION

## Phone

This unit allows for hands free calling, using your phone's Bluetooth connection to the unit, you'll be able to dial, answer, access phone book and playback music.

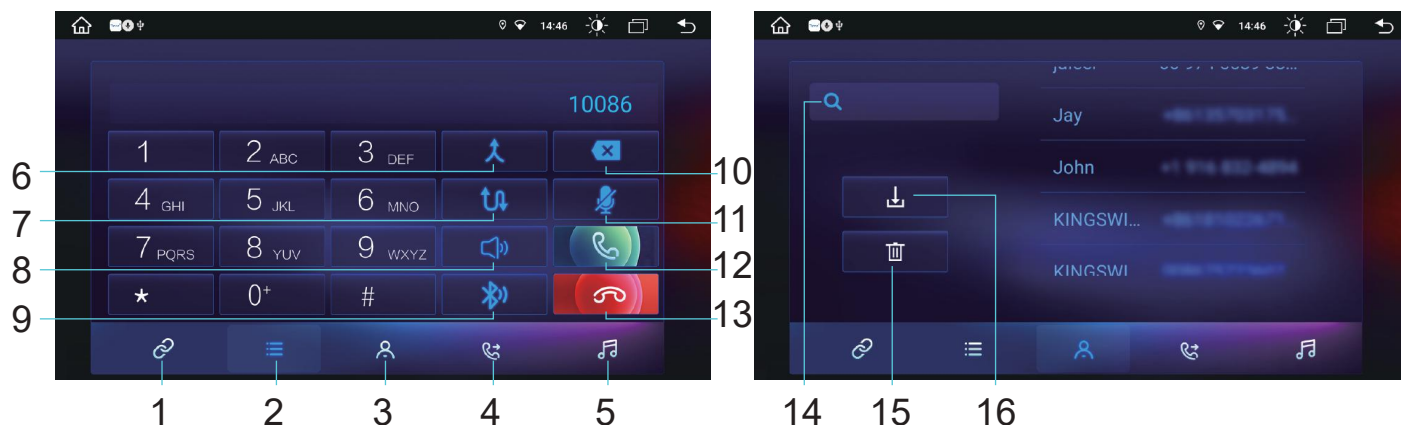

 **1 Setting:** Device Name

 **2 Keyboard:** Dial

 **3 History:** Calls record

 **4 Dial Out**

 **5 Phone Music**

 **6 Multiparty Call**

 **7 One Way Call**

 **8 Volume**

 **9 Phone/Stereo Voice Switch**

 **10** Touch it to make a call.

 **11** Touch it to hang up the call.

 **12** Touch it to delete numbers one by one, long press to delete all inputted numbers.

 **13** Touch to mute.

 **14** Search

 **15** Download Phonebook

 **16** Delete

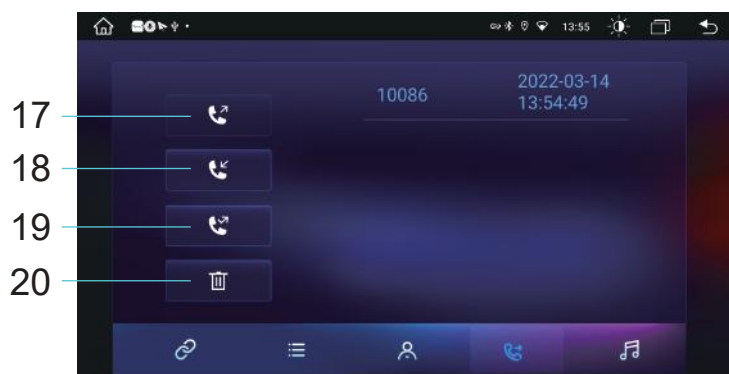

17 

18 

19 

20 

 **17** Call Out

 **18** Incoming Call

 **19** Missing Call

 **20** Delete



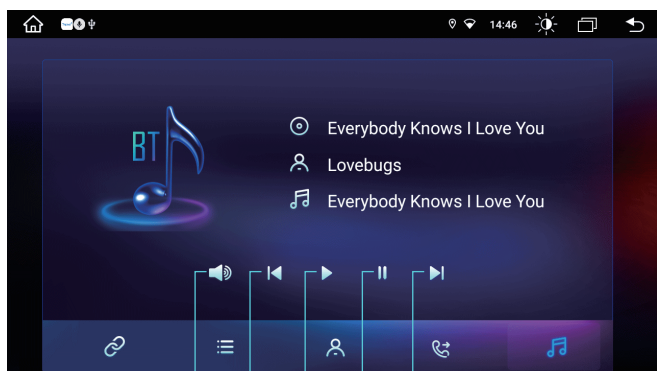

# FUNCTIONS APPLICATION

## BT Music

Touch  to enter BTmusic interface.



1 2 3 4 5

-  1 Volume
-  2 Play previous song/media
-  3 Pause current song/media
-  4 Play current song/media
-  5 Please next song/media

## Audio Music



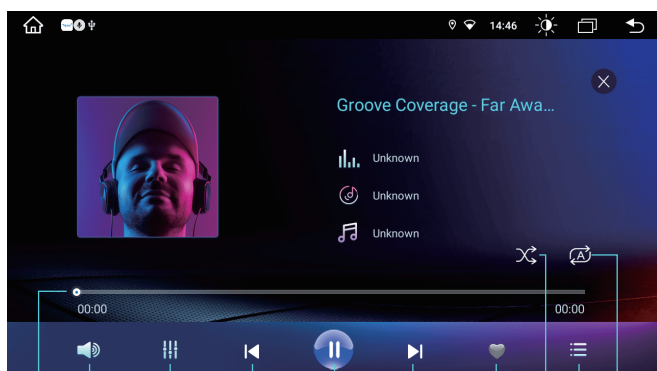



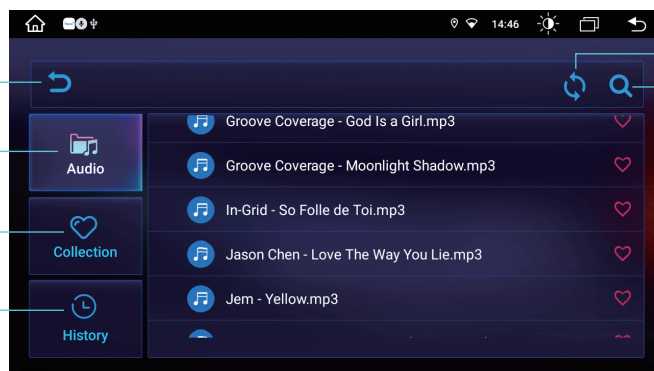









Click the " " icon on the main menu to enter in Music menu



1 2 3 4 5 6 7 8 9 10



15  
16









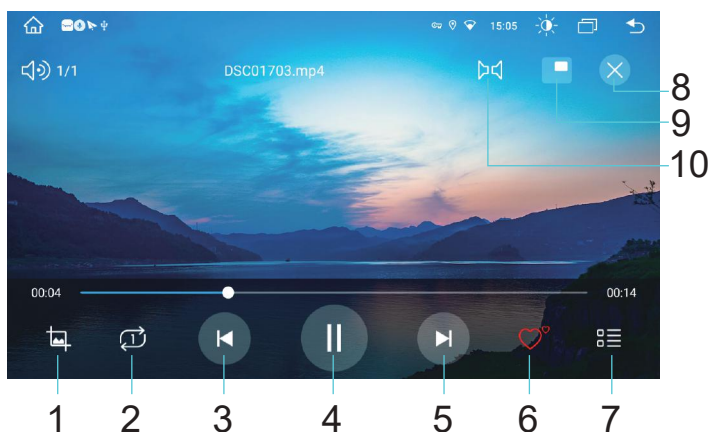

-  1 Status Bar
-  2 Volume
-  3 EQ settings
-  4 Play previous song
-  5 Play/pause current song
-  6 Please next song
-  7 Add to Favorite list
-  8 USB List Menu
-  9 Shuffle Playback
-  10 Single loop playback
-  11 Back
-  12 Audio Music List
-  13 Collection Music List
-  14 History record
-  15 Refresh
-  16 Search

# FUNCTIONS APPLICATION

## Video

Click the "  " icon on the main menu to enter in Video menu









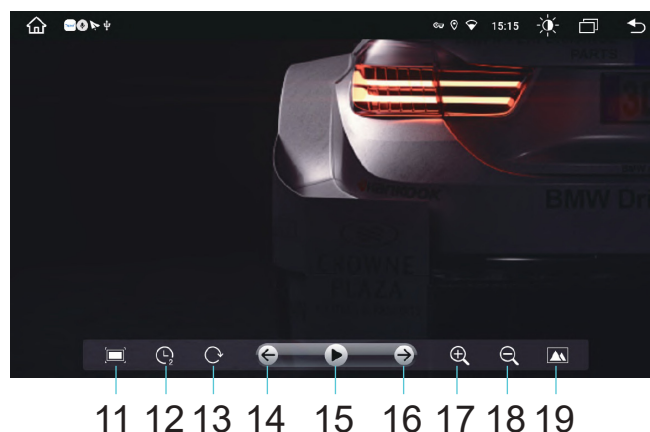

-  1 Display Zoom
-  2 Repeat/Random
-  3 Play previous media
-  4 Play/pause current media
-  5 Play next media
-  6 Add to Favorite list
-  7 USB List Menu
-  8 Stereo Sound
-  9 Picture in picture
-  10 Exit

## Picture

Click the "  " icon on the main menu to enter in Picture menu



-  11 Photo Zoom
-  12 Slide Show
-  13 Rotate photo
-  14 Play previous media
-  15 Play/pause current picture
-  16 Add to Favorite list
-  17 Zoom in a picture
-  18 Zoom out a picture
-  19 USB List Menu

# FUNCTIONS APPLICATION

## AutoLink

Click the "  " icon on the main menu to enter in Carplay/Android menu

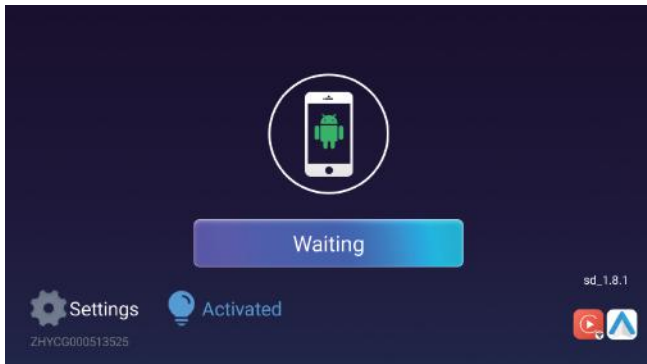

## How to enable Apple Carplay for Iphone via AutoLink application

### F10-Wired Carplay:

- 1.Prepare your phone USB Cable, and make sure it was original or Mifi-authenti cated;
- 2.For Stereo: Use the USB Cable wire to the USB plug in color Grey, then enter the "AutoLink ".

For Phone: Use the USB Cable wire to your phone--Wait and Agree "Use Car Play".

- 3.For Stereo: Waiting for the connecting in "AutoLink"--Connection Successful.

### F10-PRO-Wireless Carplay:

- 1.Turn on the Wifi & Bluetooth both in Stereo & Phone;

- 2.In Stereo: Enter the "AutoLink ".

In Phone: Search other Devices, and select "DEV-NAME"-Confirm the Pin No. and Agree "Use CarPlay".

- 3.In Stereo: Waiting for the connecting in "AutoLink "-Connection Successful.

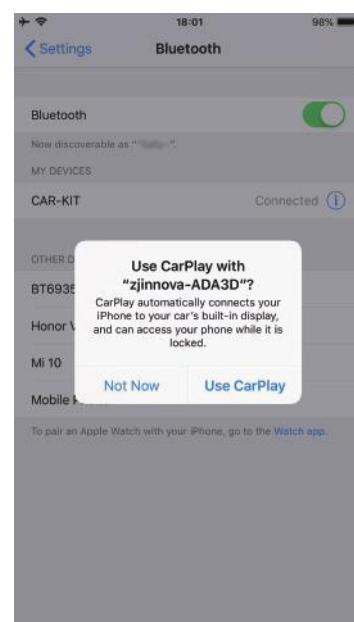

# FUNCTIONS APPLICATION

---

## F10/F10-PRO-Wired Android Auto:

1.Prepare your phone USB Cable, and make sure it was original or available for data transfer;

2.For Stereo: Use the USB Cable wire to the 4 PIN USB plug in color Grey, then enter the "AutoLink ".

For Phone: Use the USB Cable wire to your phone--Wait and Agree "Allow to read phone data".

3.For Stereo: Waiting for the connecting in "AutoLink "--Connection Successful.

Wireless Connection Note: Make sure phone system in Android 11 version, support 5GHz Wi-Fi's Connectivity, and your Android Auto is the lastest version.

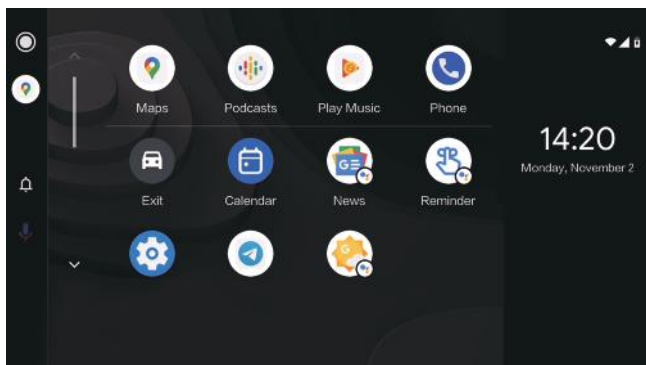

Android Auto UI

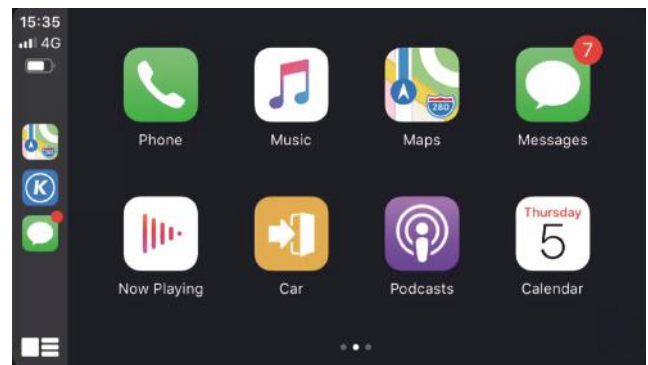





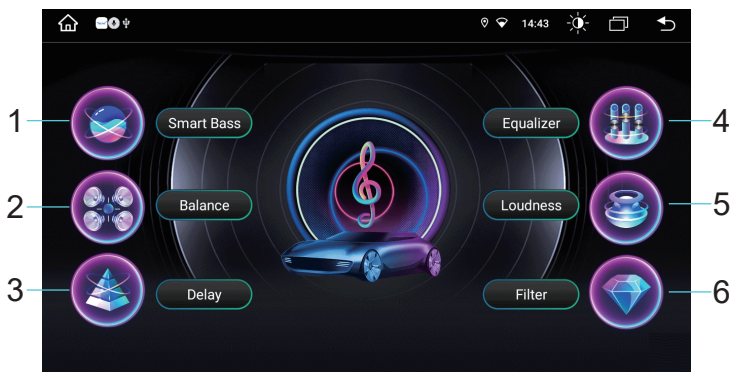

Carplay UI

# FUNCTIONS APPLICATION

## DSP

Click the "  " icon on the main menu to enter in Amplifier menu  
 Click the function to be adjusted according to each function icon



-  1 Smart Bass
-  2 Balance
-  3 Delay
-  4 Equalizer
-  5 Loudness
-  6 Filter

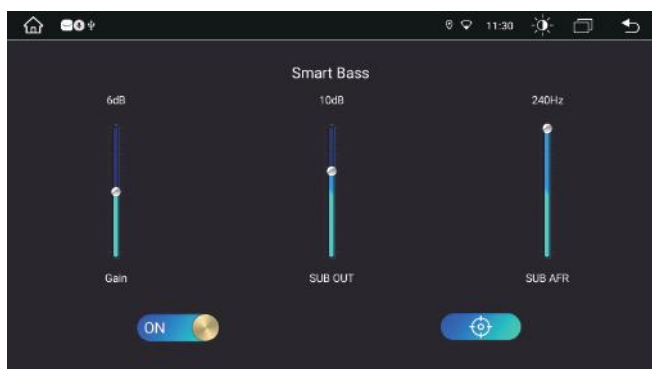

1 Smart Bass

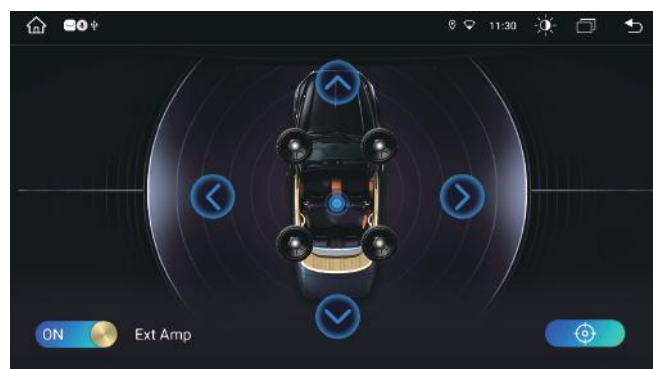

2 Balance



4 Delay



5 Equalizer: Sound effects can be set Flat, Pop, Rock, Jazz, Classic, User, Custom

# FUNCTIONS APPLICATION

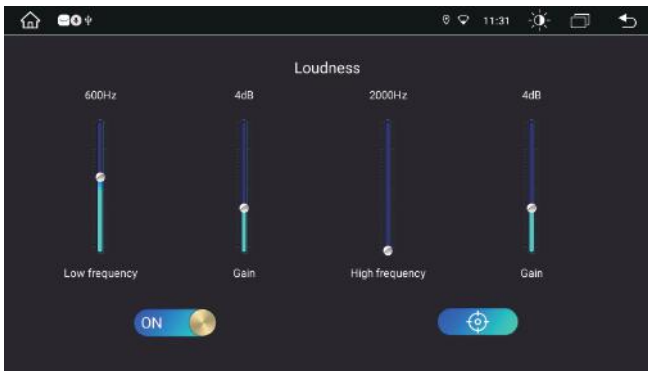

6 Loudness



7 Filter

## File Manager

Click the "  " icon on the main menu to enter in File Manager menu

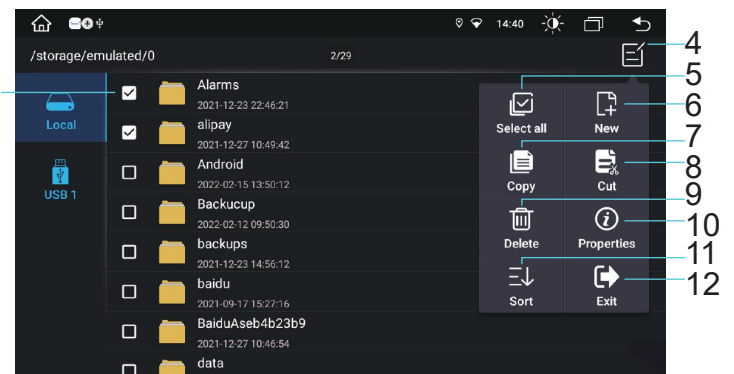
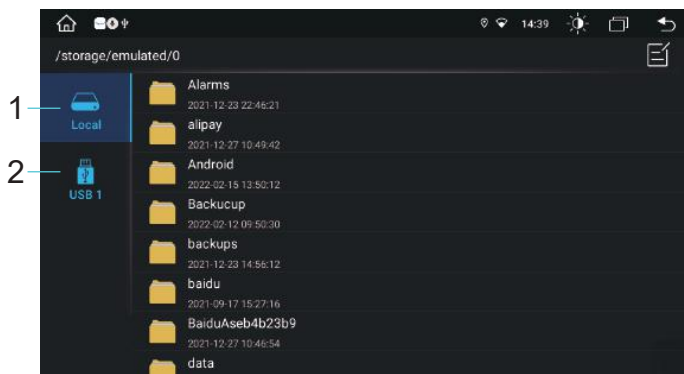

1 Stereo Inand ROM



2 USB Flash (Optional Device)



3 Select the file



4 Setting



5 Select all



6 New



7 Copy



8 Cut



9 Delete



10 Properties



11 Sort



12 Exit

# FUNCTIONS APPLICATION

## ApkInstaller

Click the "🤖" icon on the main menu to enter in APK Installer menu



## AV\_IN

Click the "📡" icon on the main menu to enter in AV\_IN menu

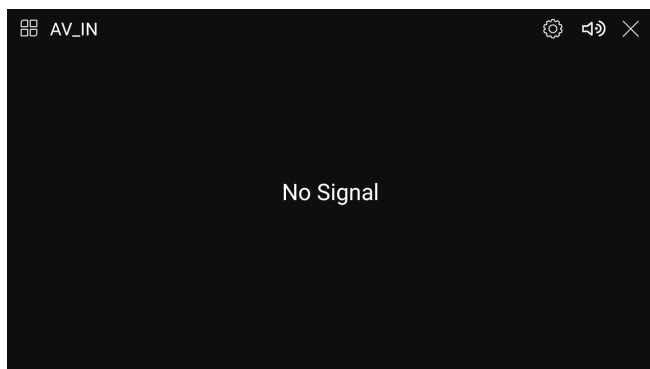

## Contacts

Click the "👤" icon on the main menu to enter in Contacts menu

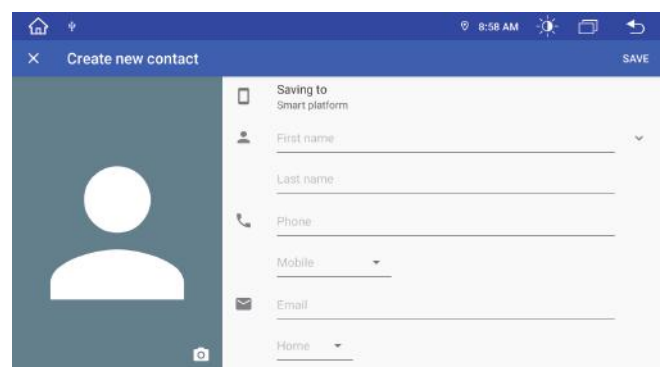
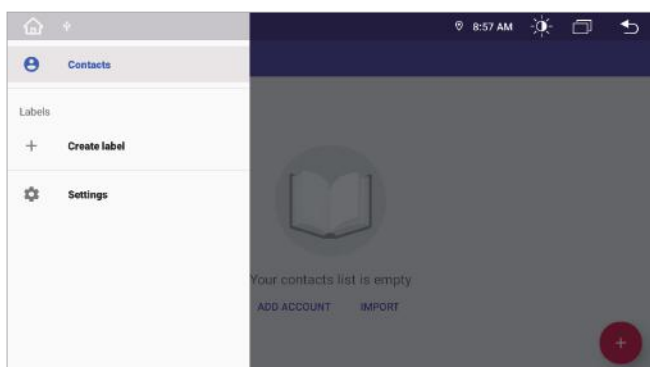
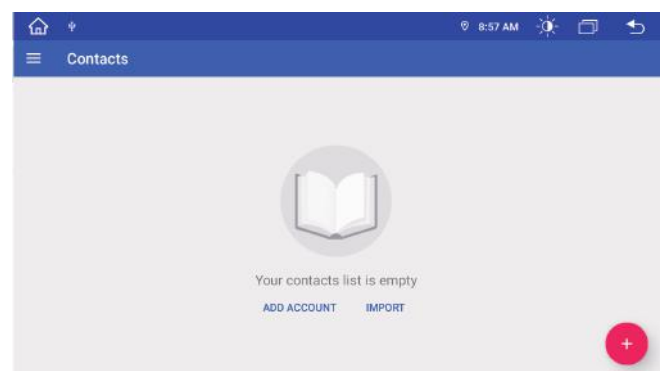

# FUNCTIONS APPLICATION

## Voice Search

Click the "  " icon on the main menu to enter in setting menu

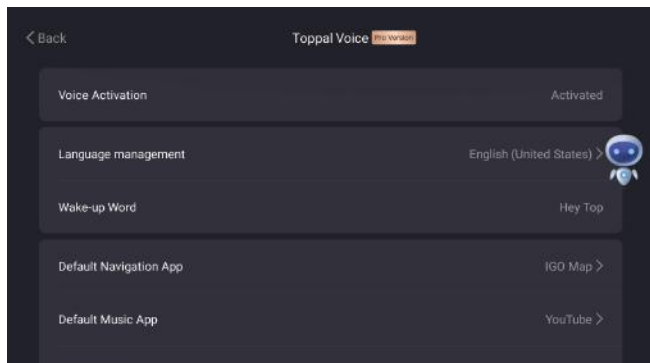

1 Toppal Voice

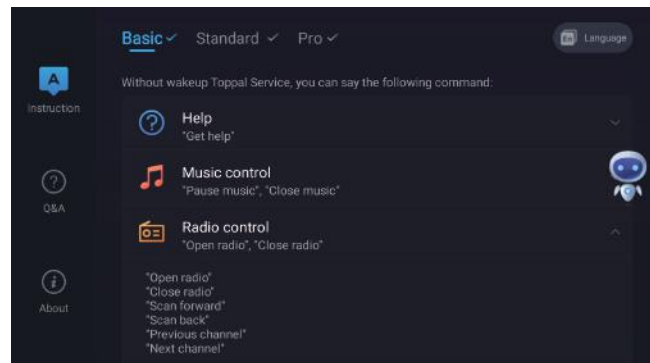

2 Instructions

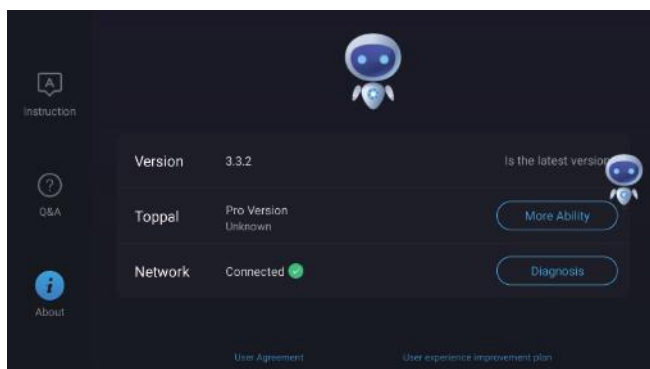

3 Toppal Version

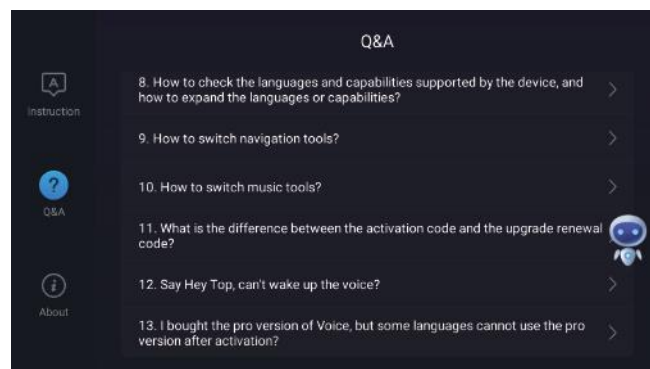

4 Q&A Voice Tips

## Introduction to voice search commands

Click 

### How to Make App Control

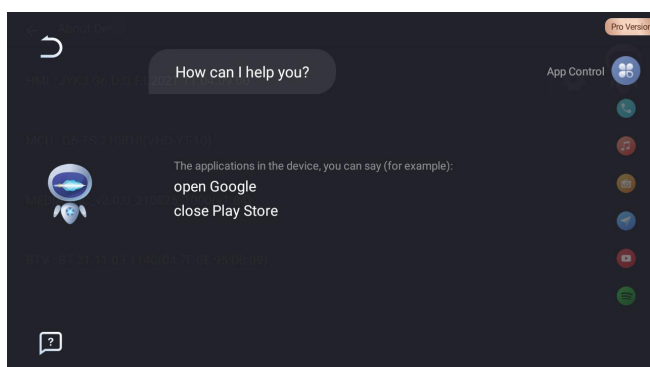

### How to make Phone Call

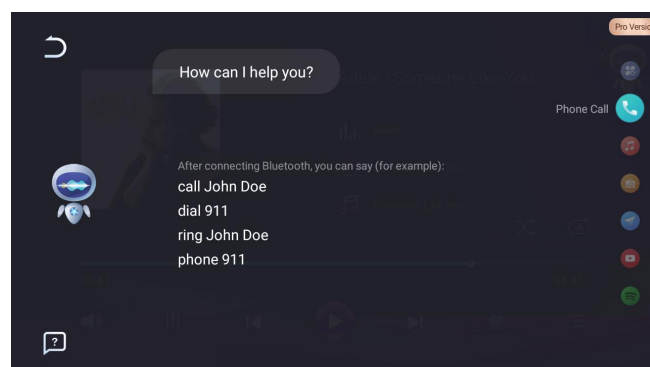

# FUNCTIONS APPLICATION

## How to Play Music



## How to Play Radio

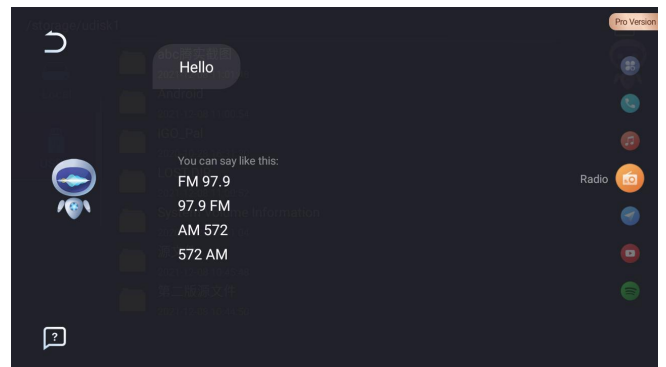

## how to set Navigation

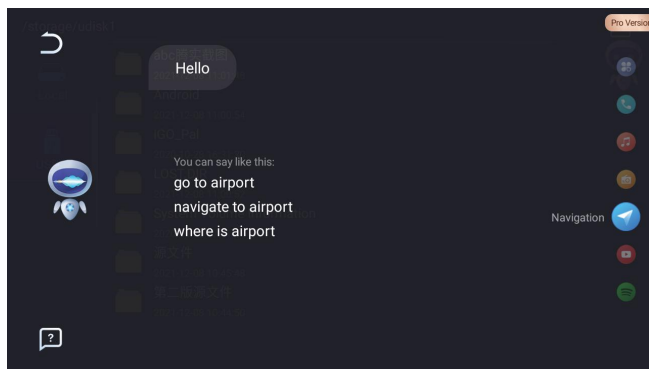

## How to use Youtube

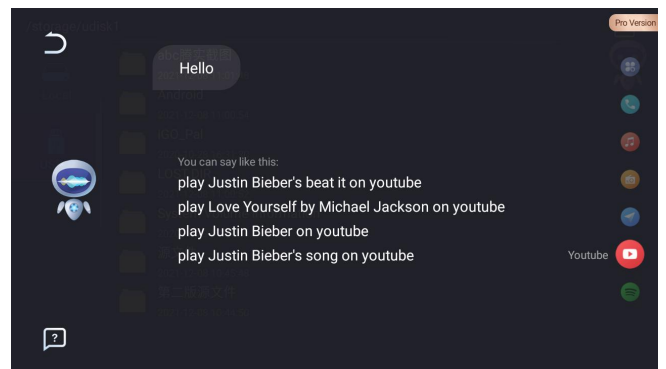

## How to use Spotify

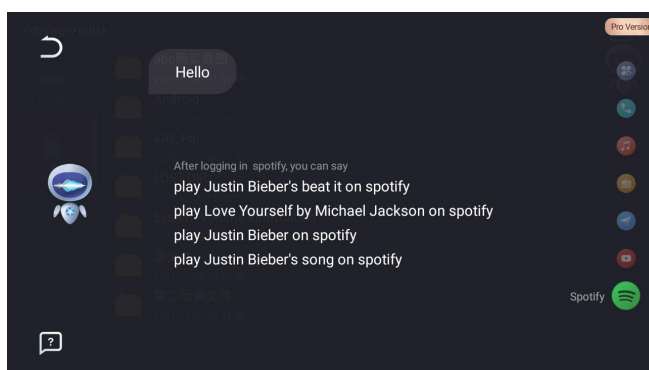

# FUNCTIONS APPLICATION

## GPS

Click the "📍" icon on the main menu to enter in Google Maps

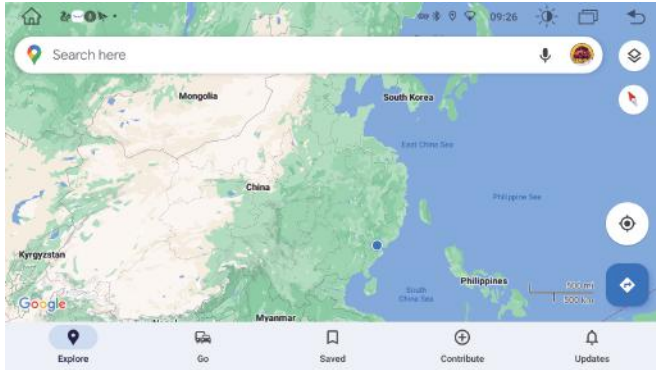

1 Set the location and destination

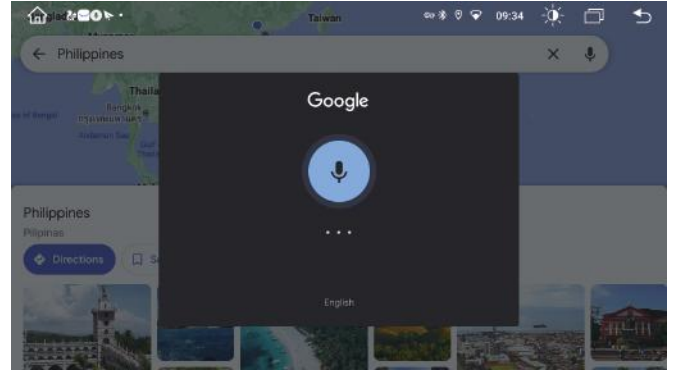

2 Click "🗣️" use the voice search

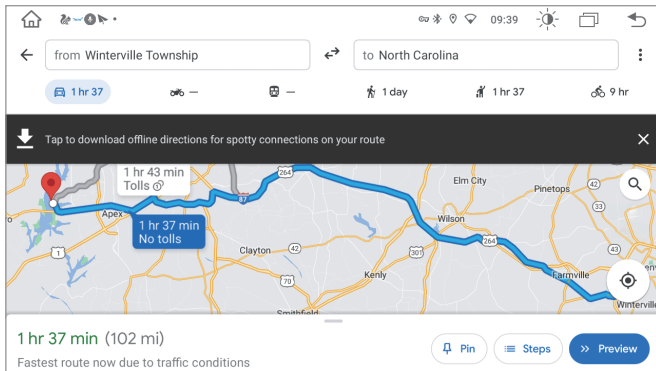

3 Say "hey google" to use the voice control, Search for your destination

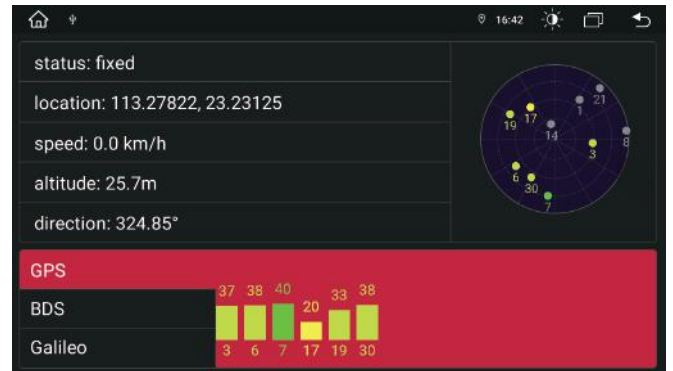

4 GPS Satellites Status

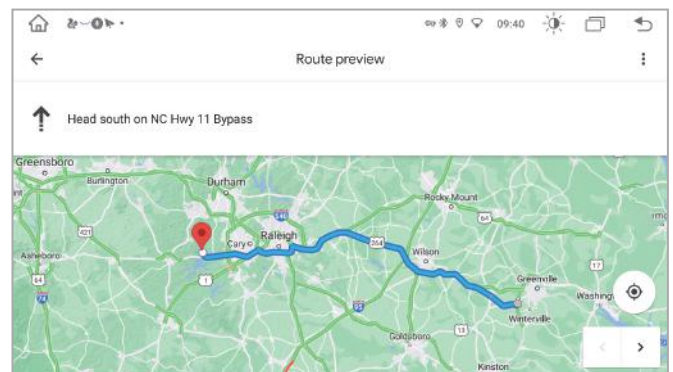
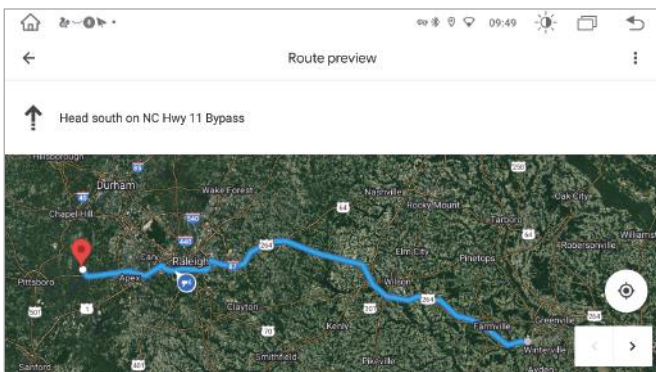

5 You can choose online or offline maps according to your network status

Note: Online map require network (Wifi/Hotspot/4G Dongle) 's connection

# FUNCTIONS APPLICATION

## Google Play

Click the "  " icon on the main menu to enter in Google Play

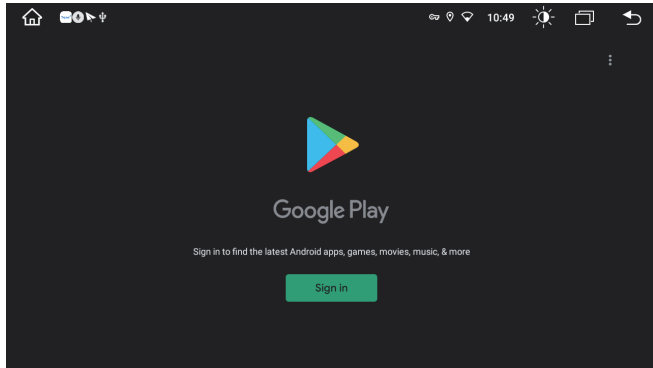

1 Option to log in to your account

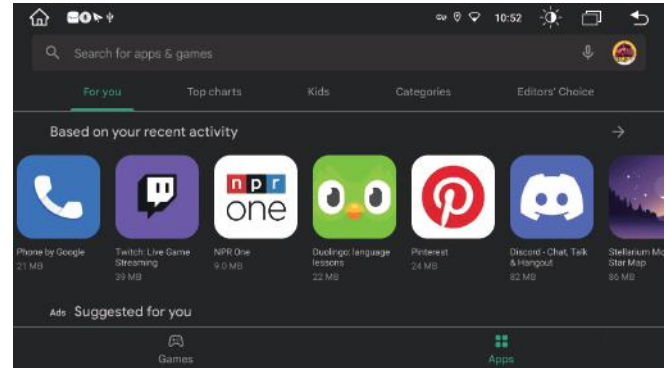

2 you can also download your favorite app like NPR One, Duolingo, Pinterest

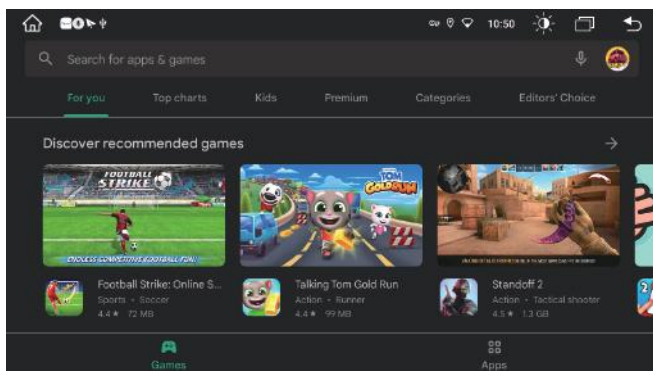

3 On google play, you can download your favorite games, movies and books

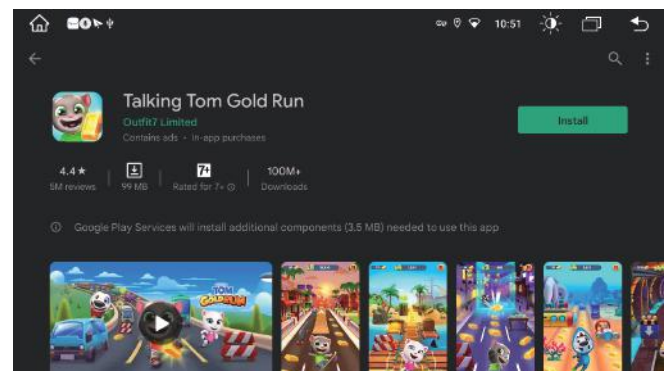

4 Choose the game you like and click to download

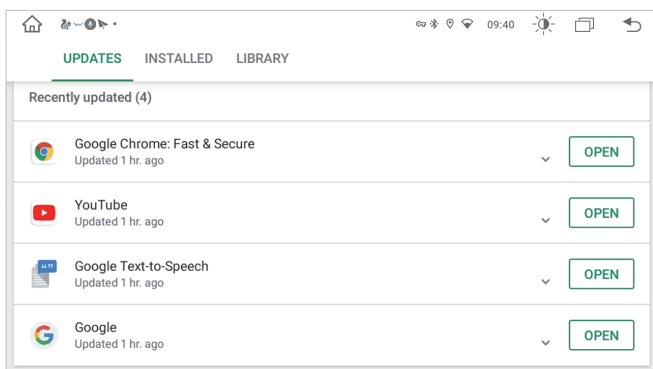

5 On my apps & games, you can update them when you need the latest version

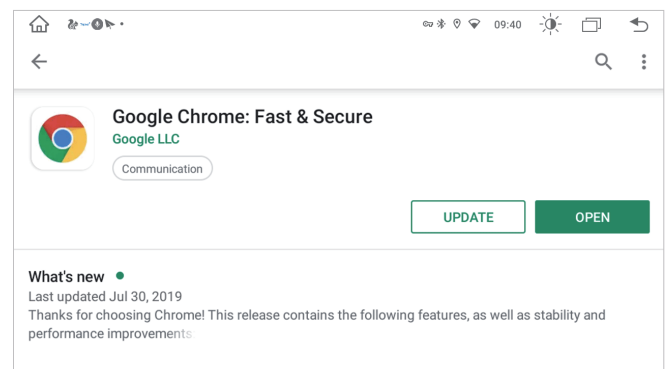

6 Select the app to update manually

# SETTINGS

## General Setting

Touch “  ” to set relevant functions on/off. More items can be accessed by sliding the menu.

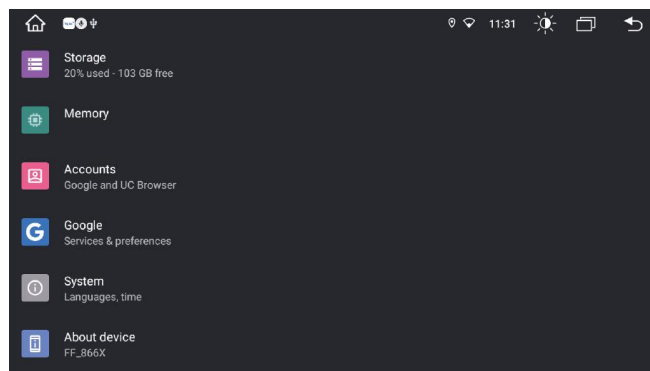
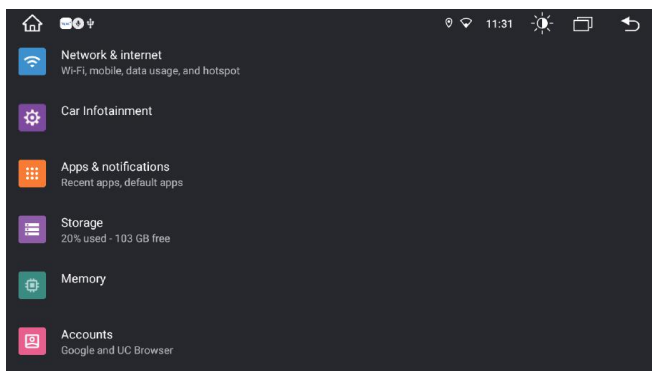

### Network & internet

Press “Network & internet” and enter the correct password

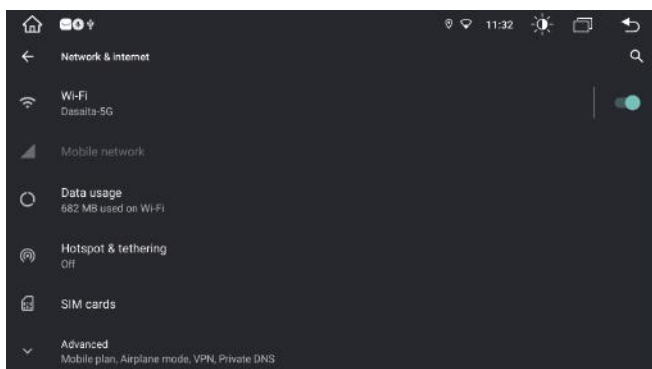

### Car Infotainment

Press “Car Infotainment” and enter the car setting

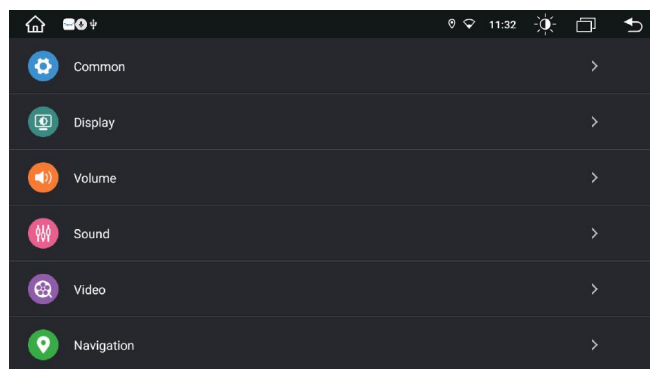

### Apps & notifications

Press “Apps & notifications”, can see the opened apps and set the notifications

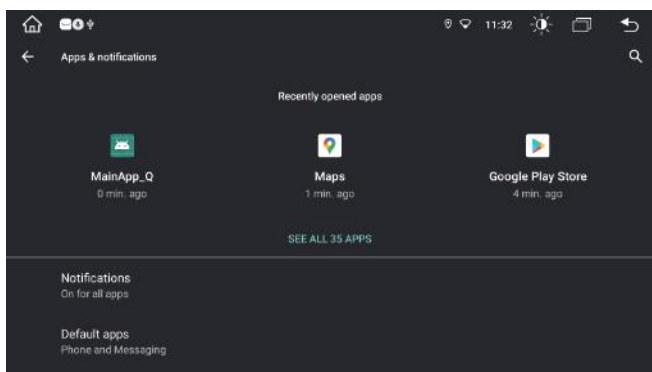

### Storage

Press “Storage” and check the storage details

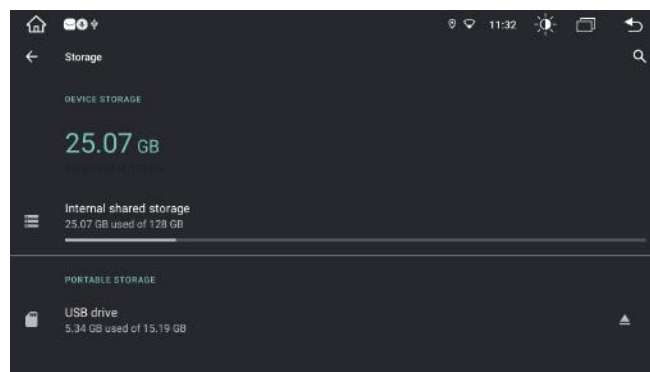

# SETTINGS

## Memory

Press "Memory" and check the Memory details

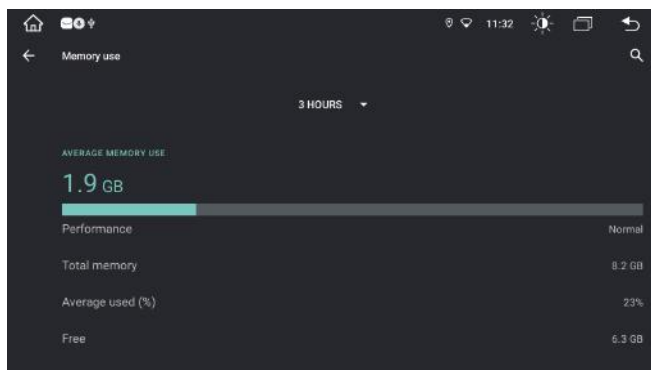

## Car Infotainment

Press "Account" to add the account for the owner (need internet via set up)

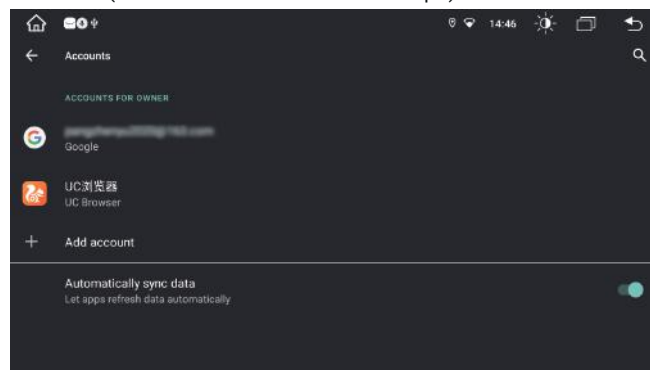

## Google

Click Google to check Service and set preferences

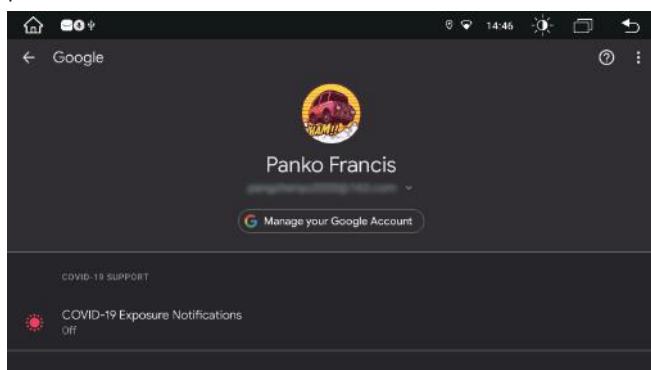

## About device

Press "About device" to check the unit details

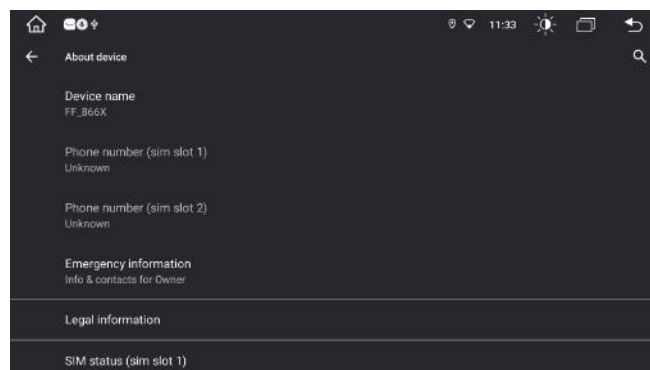

## System

Click "System" to set languages,time

### Languages & input:

Click Languages to set system languages and set the default Keyboard & input

### Date & time :

Set the unit time, automatic or manual, provide by GPS or internet

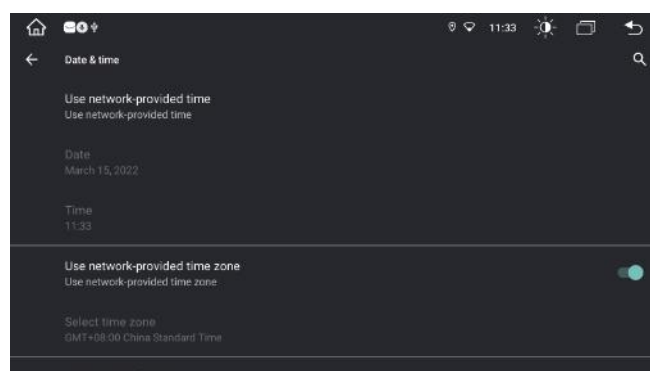
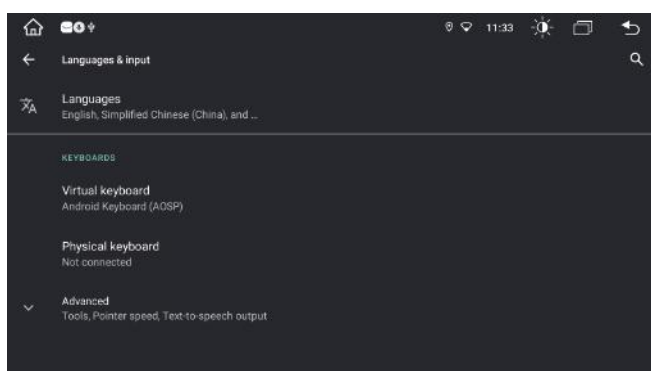
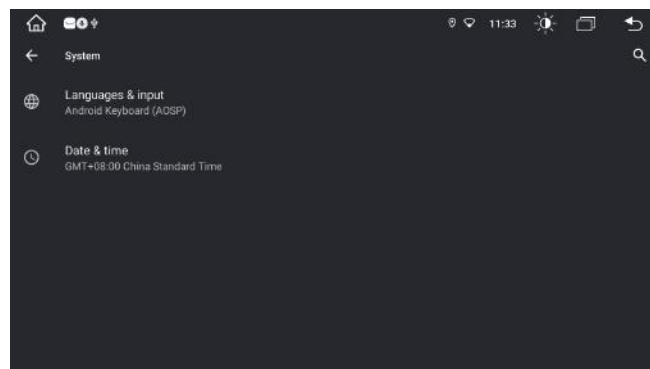

# SETTINGS

## Car Setting

Touch “  ” to set relevant functions on/off. More items can be accessed by sliding the menu.

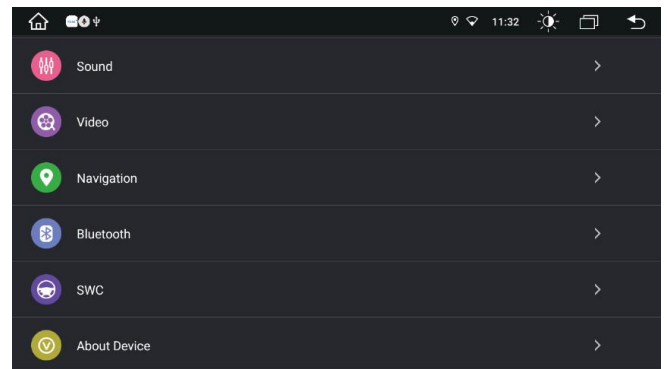
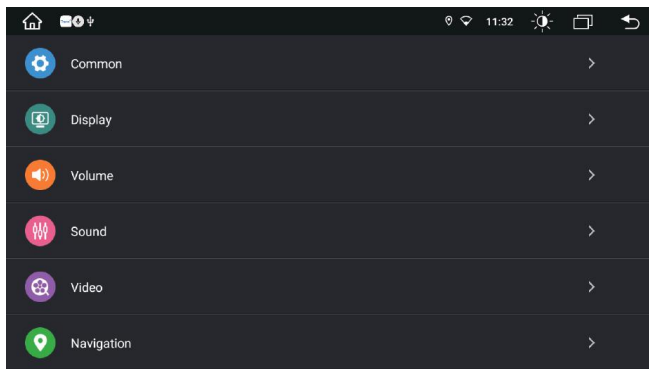

### Common

Press "Common" to set Sleep mode/ AssistiveTouch/Reverse Volume Suppression

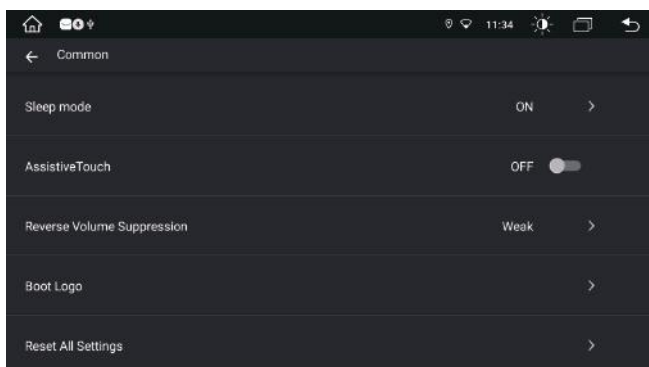

### Display

Touch " Display " Set Daytime Backlight Set/ Nighttime Backlight Set/Auto Mode/Key Light Color

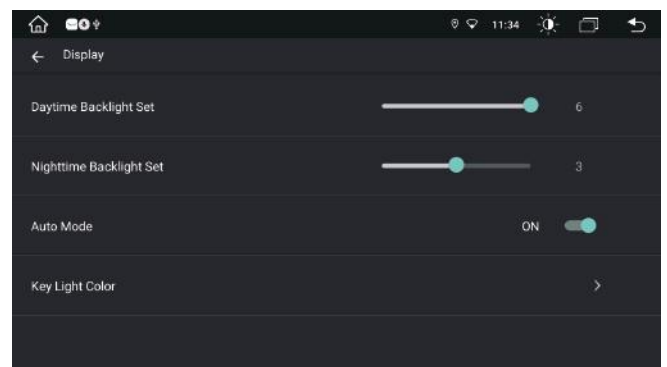

### Volume

Press "Volume" to Set Volume Up/Down

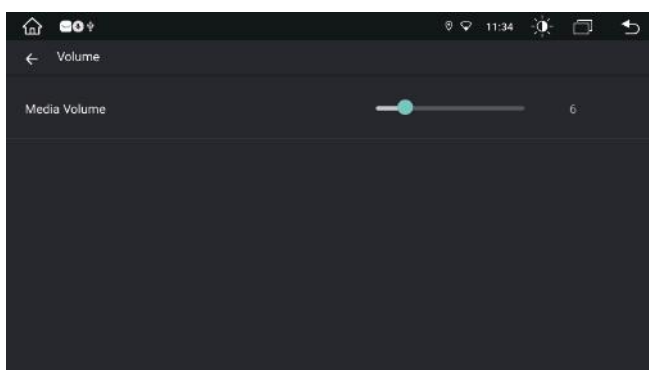

### Sound

Press "Sound" to set DSP settings

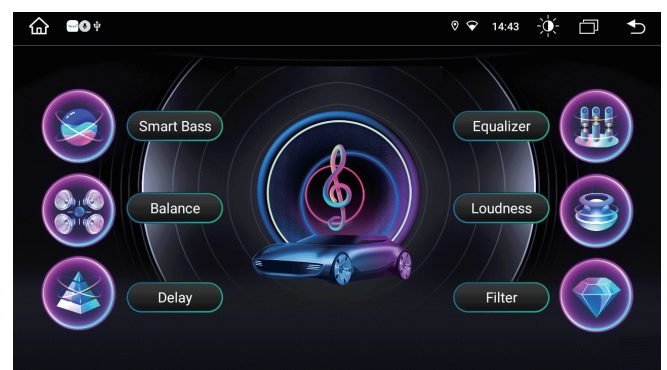

# SETTINGS

## Video

Press "Video" to set Video in motion/Reversing Assistant Line/Reversing Warning line/Air Conditioner

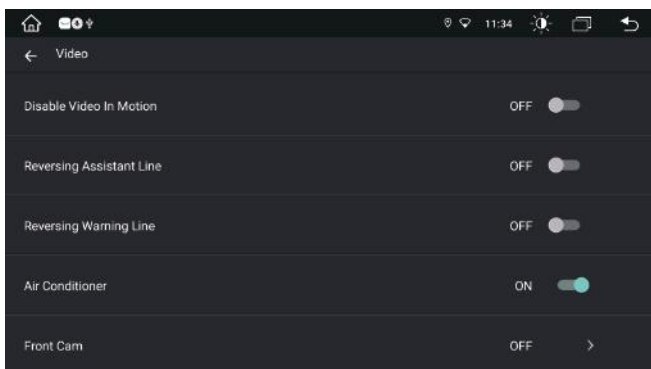

## Navigation

Press "Navigation" to set default Navigation apps

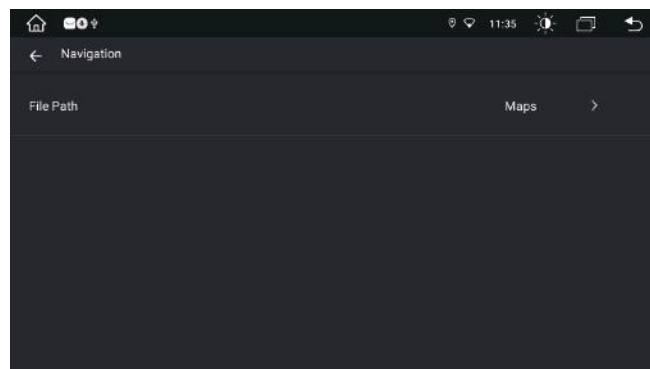

## Bluetooth

Press "Bluetooth" to set Auto Connect/Auto Answer

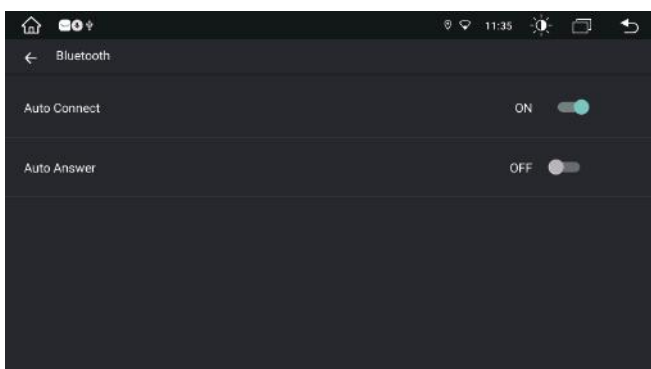

## SWC

Press "SWC" to set steering wheel control (no need set if your unit come with canbus)

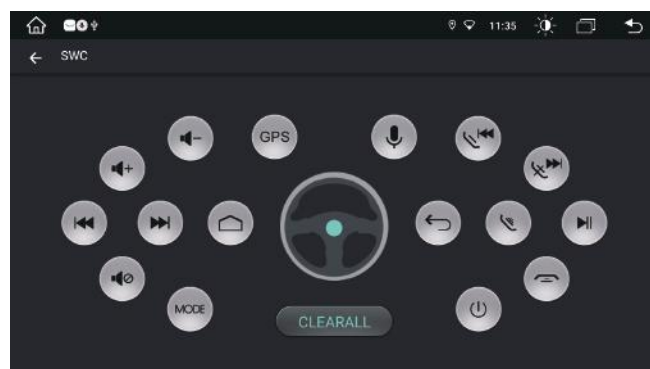

## About Device

Press "about device" to see Device versions

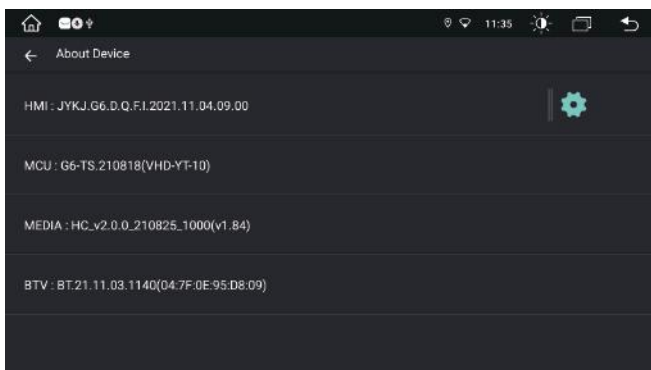

Click Setting-Car-Factory setting, password 8878

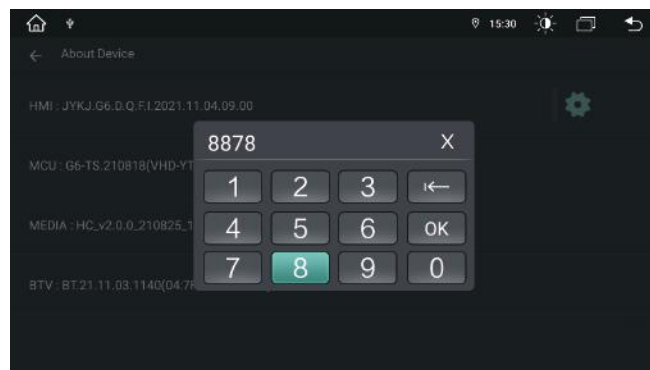

# SETTINGS

## Factory Setup

Press "factory setup" to Choose default settings

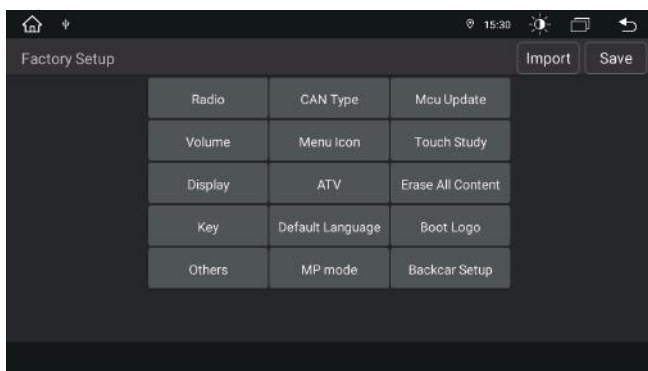

## Radio

Press "Radio" to set radio default setting

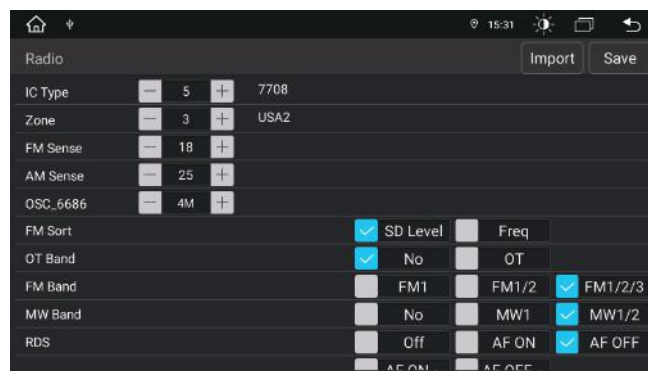

## CAN Type

Press "CANBUS" to set canbus default setting (need canbus harness support)

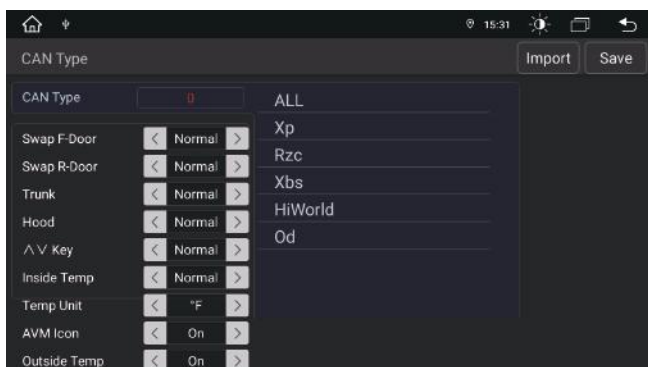

## Mcu Update

Press "MCU update" to update MCU (MCU files require)

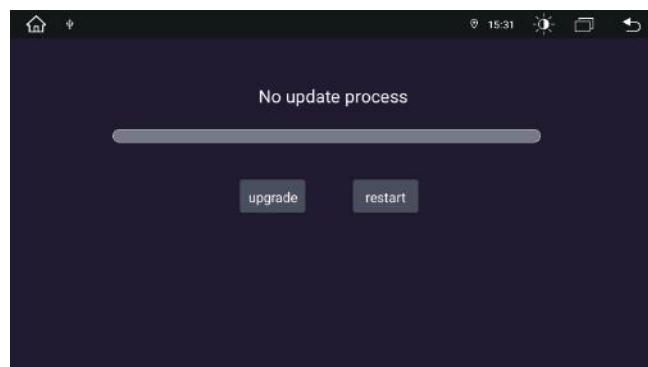

## Volume

Press "Volume" to set app default volume



## Menu Icon

Press "Menu Icon" to set unit default function on main page

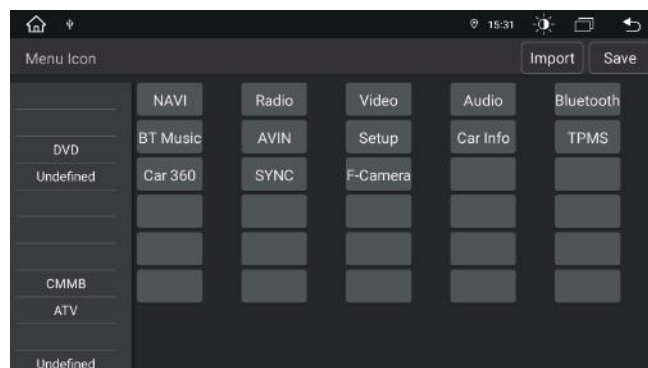

# SETTINGS

## Touch Study

Press "Touch Study" to set Screen panel icon functions



## Display

Press "Display" to set Brightness/Contrast/Tone/Saturation/Reverse

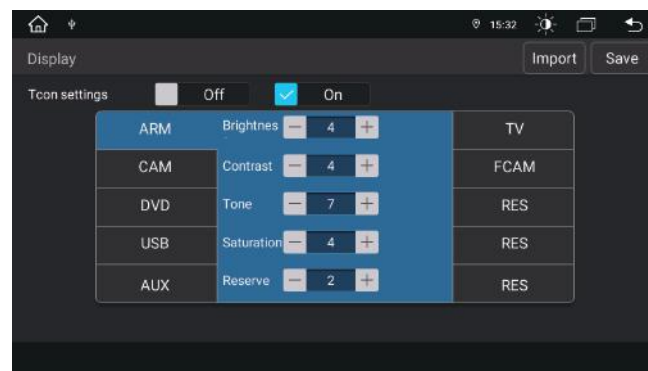

## ATV

Press "ATV" to set PAL/NTSC/SECAM (optional device require)



## Erase All Content

Press "OK" to Erase All Content

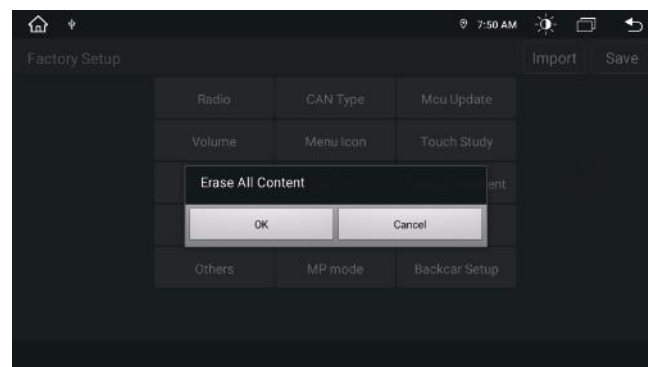

## Key

Press "Import" import Key files from SD to Unit

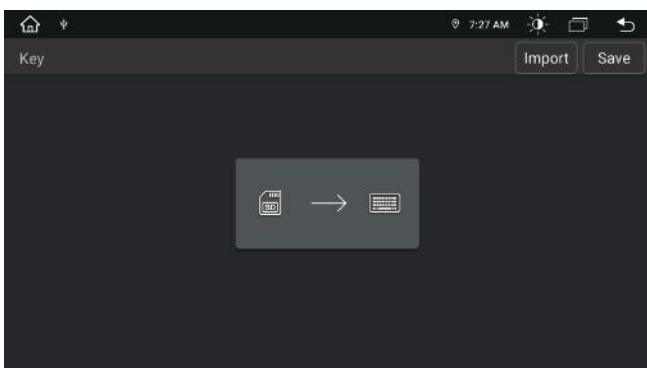

## Default Language

Press "Default Language" to set unit default language

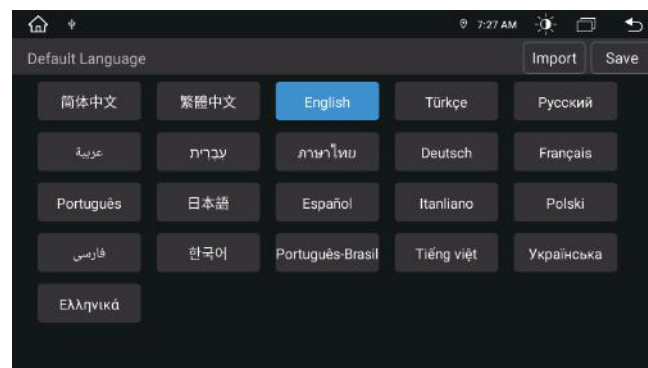

# SETTINGS

## Boot Logo

Press LOGO to set up start logo

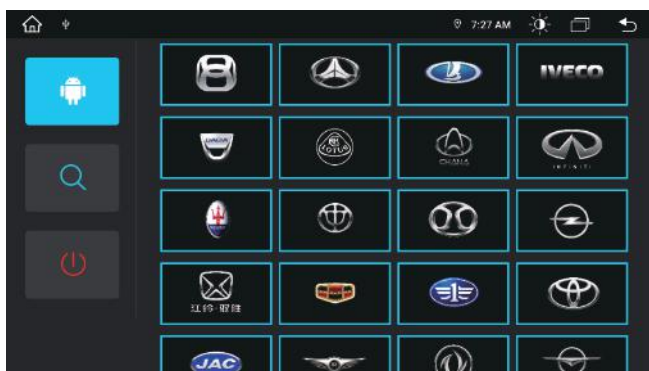

## Others

Press Other to set relevance settings

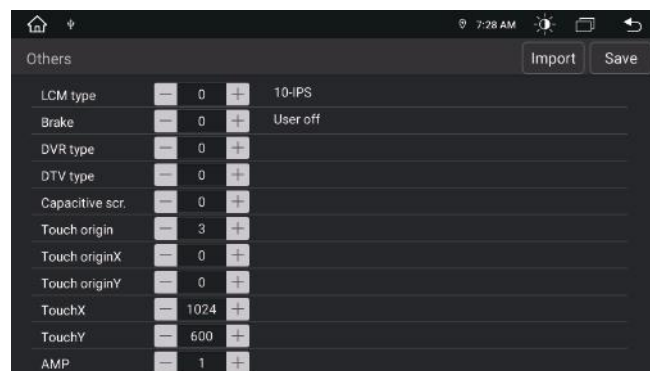

## MP mode

Press "MP mode" to save files to SD Or USB

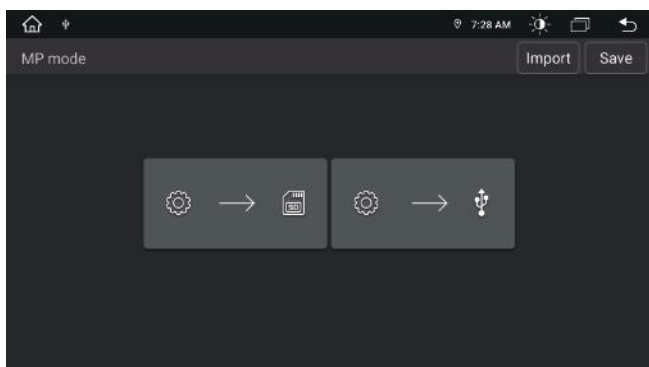

## Backcar Setup

Press "Backcar Setup" to set CAM type

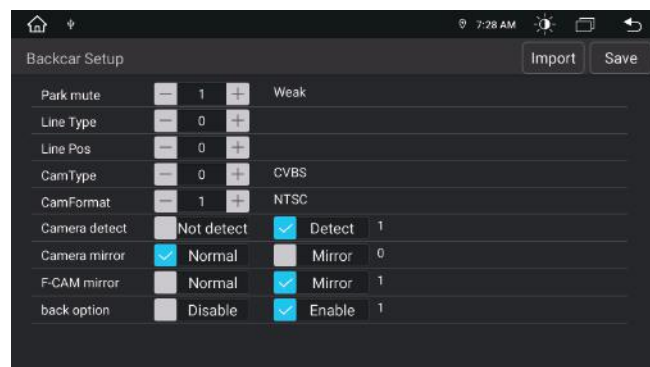

## Car Info

Click the "🚗" icon on the main menu to enter in Car Info menu

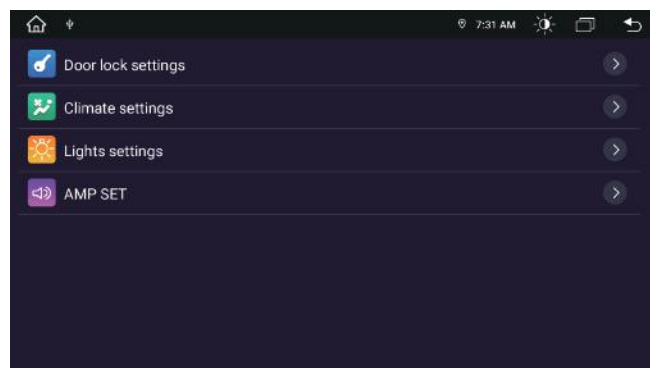
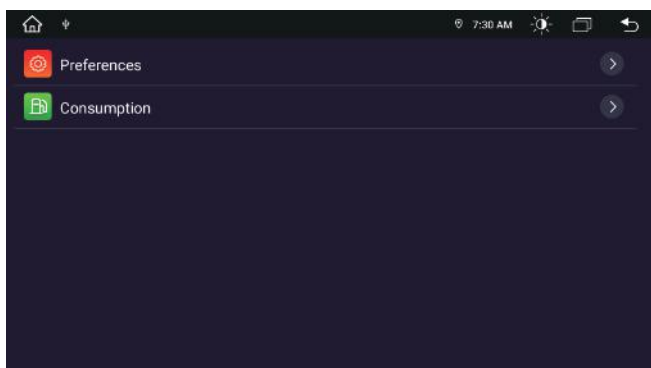

1 Original Car Settings: Preferences/ Consumption (if original car does not have these functions will not work)

2 Door lock settings/Climate settings/ Lights settings/AMP SET

# SETTINGS

---

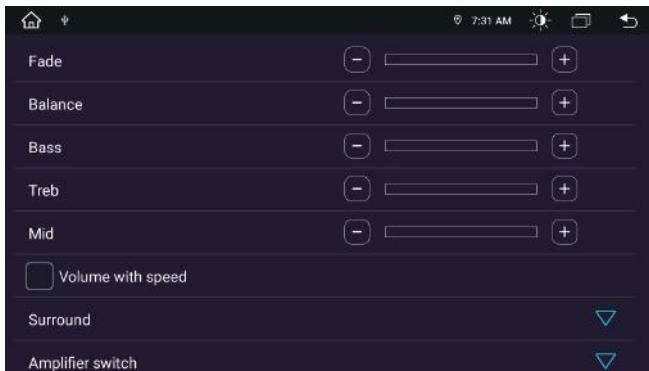

3 Original Amplifier Settings

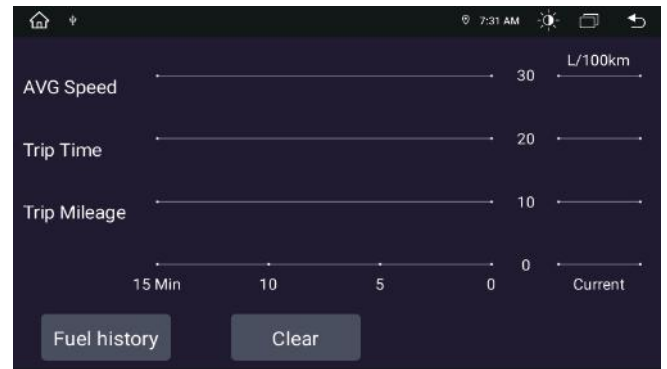

4 Original Car Full status

# INSTALLATION OF GPS ANTENNA

## ⚠ Warning

Recommend installing the GPS antenna on dashboard or rear shelf. The antenna should be installed on leveled surface facing the sky to prevent blockage of radio waves as little as possible. Vehicle equipped with tempered glass or tint may weaken the receiving signal of the GPS antenna. Thus, recommend installing the antenna outside of the vehicle.

## GPS Installation Guide

Before affixing the GPS antenna, please ensure using the suitable cleaner to clean the designated surface. After cleaning, tear off the back of the tape and press to place the GPS antenna.

Remove the side cover, move the cable through the storage box until it reaches the control panel of the machine. The cable needs to be fixed with a cable tie.

Connect the GPS antenna's plug to the machine

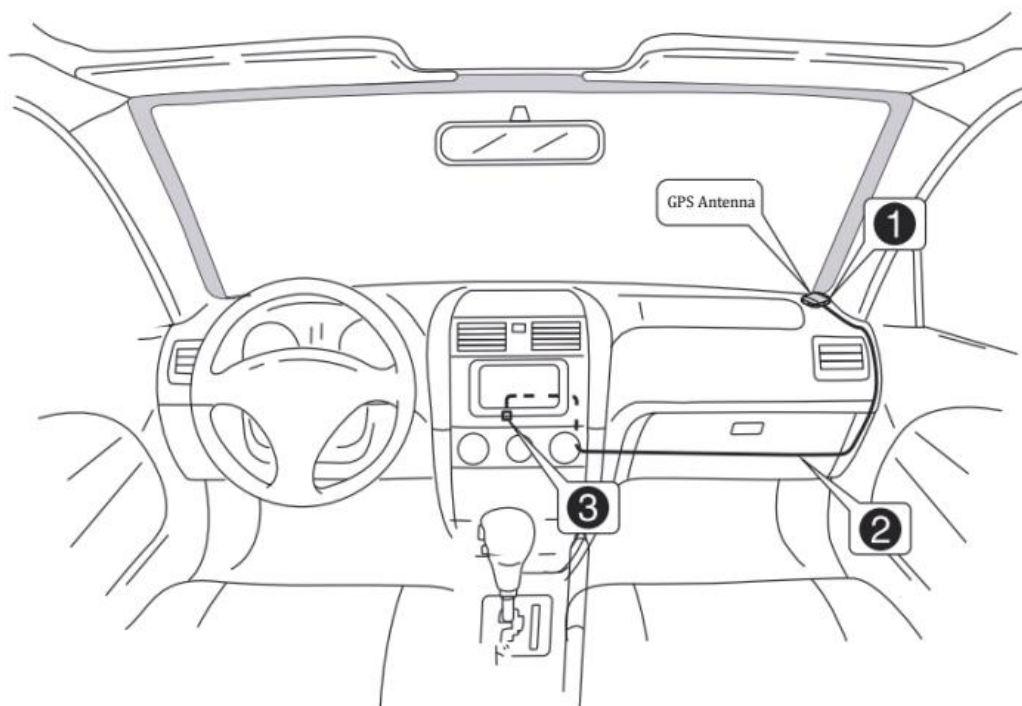

### Notes

- 1 Please ensure the system power is off when connecting to the GPS antenna. GPS Antenna42 / 45
- 2 Please do not shorten or extend the GPS cable. Altering the length of the cable may result in short circuit or malfunction that may damage the product.
- 3 The antenna should be installed on a leveled surface where radio waves will be blocked as little as possible, otherwise it will affect the accuracy of navigation.
- 4 Please do not interfere the GPS antenna with steering wheel or gear lever, as it may be dangerous.

# DIAGRAM

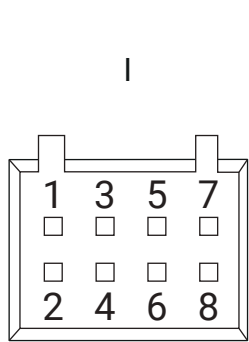
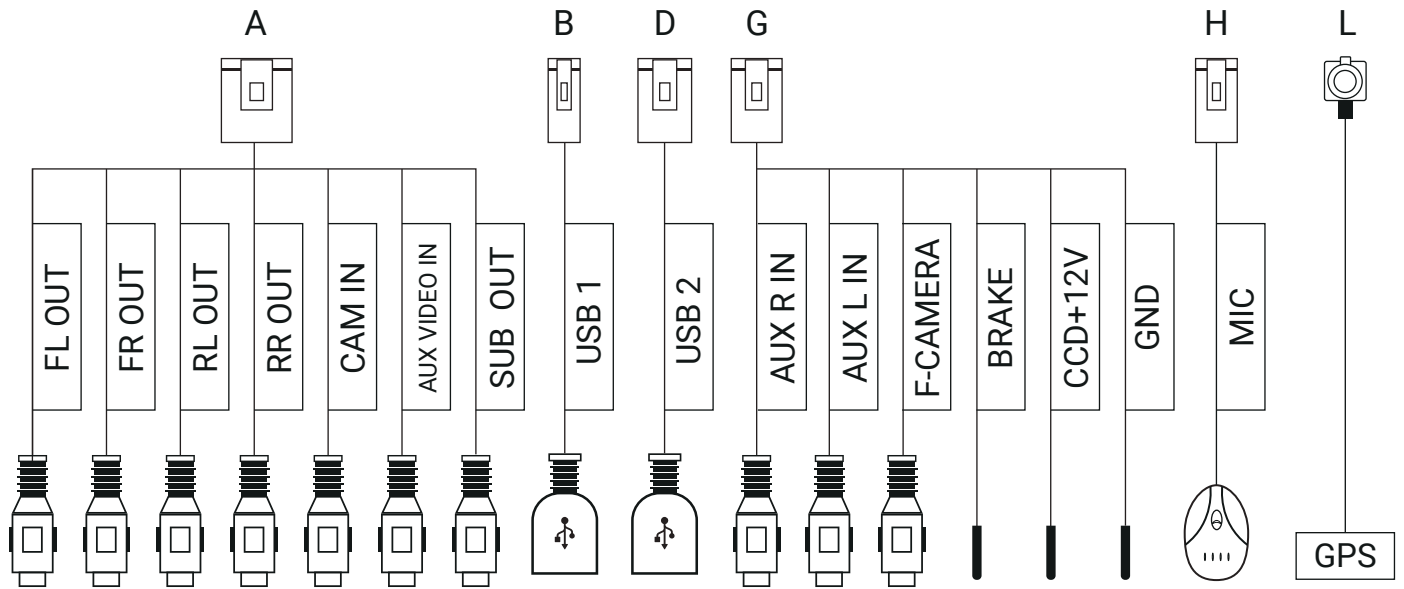
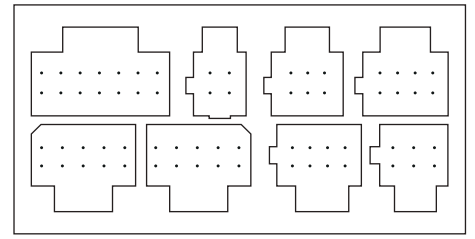
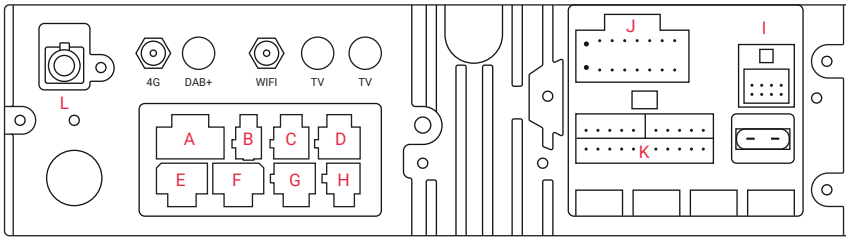

I connector	
1	
2	
3	
4	
5	
6	
7	CAN-RX
8	CAN-TX

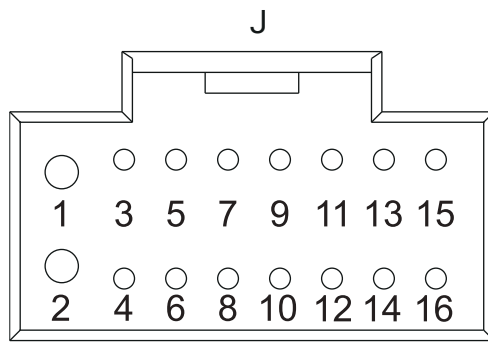

J connector	
1	GND
2	B+
3	ACC
4	ILL
5	BACK
6	SWC-B
7	SWC-A
8	ANT.POWER
9	FR-
10	RL-
11	FR+
12	RL+
13	FL-
14	RR+
15	FL+
16	RR-

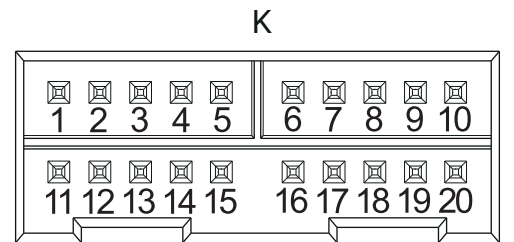

K connector			
1	CAN_RX	2	Reverse
3	ACC	4	illumination
5	Key2	6	Key1
7	RL-	8	RL+
9	FL-	10	FL+
11	CAN_TX	12	ANT
13	AMP	14	Brake
15	GND	16	B+
17	RR-	18	RR+
19	FR-	20	FR+

These instructions must be read and understood completely before attempting installation

# REAR VIEW CAMERA CONNECTION

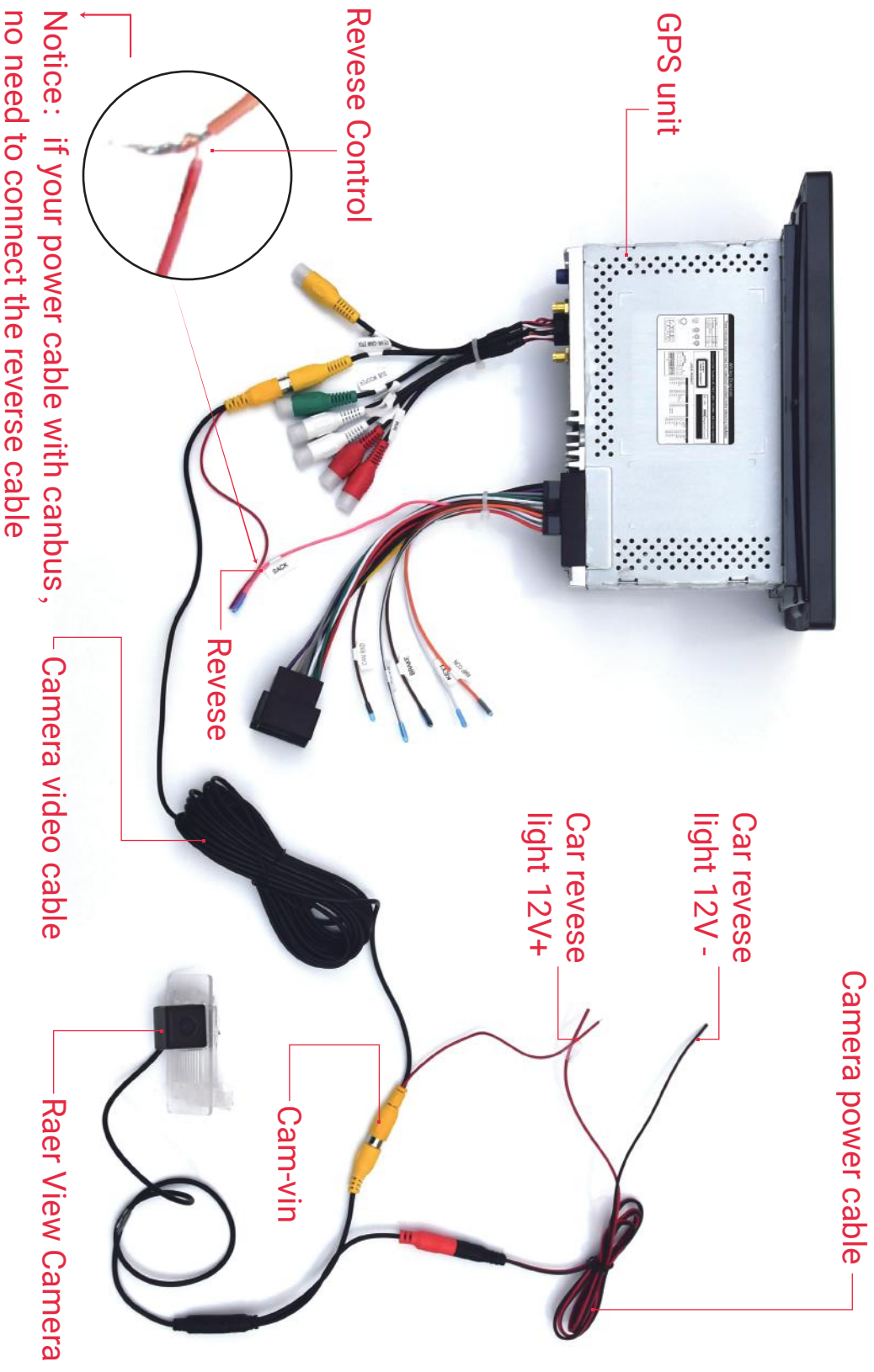

These instructions must be read and understood completely before attempting installation

# FRONT VIEW CAMERA CONNECTION

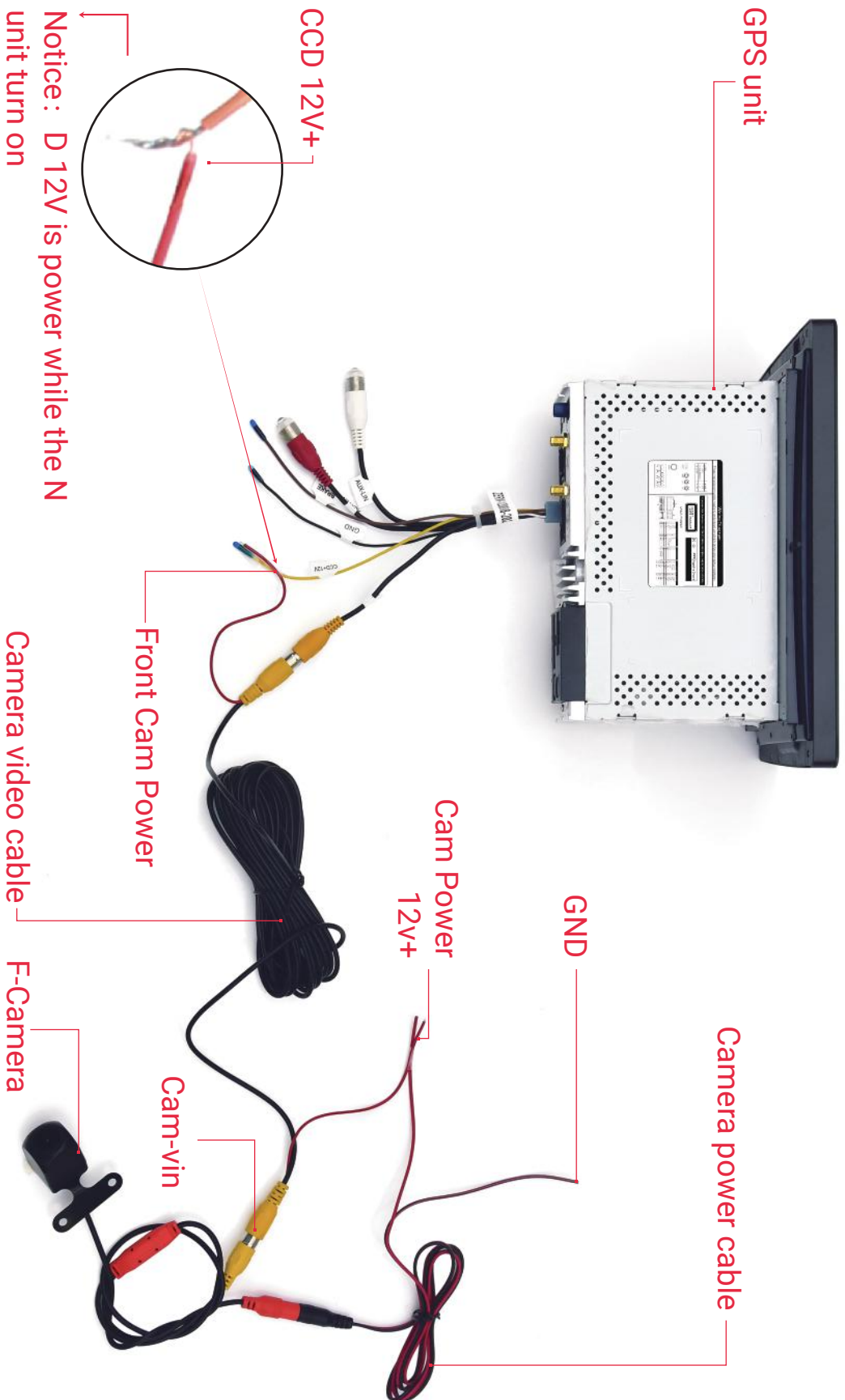

These instructions must be read and understood completely before attempting installation

# FREQUENTLY ASKED QUESTIONS

---

Q: What is the factory setting password ?

A: 8878

Q: How to set the fast boot ?

A: Click Setting-Car Infotament-Common-Sleep Mode-Set On.

Q: How to reset the side button ?

A: Click Setting-About Device -Click SETTING ICON, password 8878, click Touch study.

Q: How to change the default navigation App ?

A: Click Setting-Car Infotament-Navigation File Path, then choose your navigation App.

Q: How to listen Music when you are in reverse ?

A: Click Setting-Car-Infotament-Reverse Volume Suppression-Set Weak/Medium/Strong.

Q: How to fix reversed camera image?

A: Click Setting-About Device -Click SETTING ICON, password 8878-the Backcar SetupCamera mirror set Normal.

Q: My XM radio can work with this stereo ?

A: It doesn't support XM radio, but you can access the same channels using the XM online radio.

Q: What kind of sd card can work with this stereo ?

A: It supports SD card / USB drive up to 64GB with FAT32 or ntfs Format.

As for the hard disk, does not work all type HHD and SSD (Please ask the dealer for more details)

Q: How to out of recovery mode ?

A: Use the pin to press the RST hole(in the panel of our stereo) to choose the factory reset.

# FREQUENTLY ASKED QUESTIONS

---

Q: How to update the unit ?

A: Please contact your dealer to download the MCU/UPDATE files and copy to the USB or SD card, plug to the SD port or USB port. the system update automatically (Make sure only Update file in the USB to be recognized.)

Please Note: If the unit without problem , don't update the unit.

Q: How do I connect the camera to your unit?

A: Please connect your camera video output cable to our unit camera in video cable. make sure your camera power also connect correctly.

Tips: normally if your unit has CANBUS, the unit will go reverse image automatically, if your unit does not have CANBUS, you need connect the reverse detect cable manually.

Q: I do not have camera, but the unit go reverse image automatically and shows a black screen with an exclamation point in a yellow triangle, can I turn it off ?

A: Click Setting-About Device -Click SETTING ICON, password 8878- Backup set up Camera detect set not detect

Q:How to see the guides if my car has original rear camera?

A:Click Setting-About Device -Click SETTING ICON, password 8878-Bacp setup Line type set 1.

Q:How to cancel the screen saver?

A:Click Setting-Display-Audio Screen Timeout-Off.

Q:How to get the image when i use the video application?

A:Click Setting-Car Infotament-Video-Disable Video In Motion-Set On.

# TROUBLE SHOOTING

Problem	The Reason	Remedy
No power supply	Wrong connection between wires and connector	Make sure all connections are correct
	Broken fuse/do not turn on car ACC	Find out the reason of the broken fuse, and then replace it with the identical fuse/to turn on car ACC
	The built-in microprocessor is unable to work normally due to the noise and other factors	Press RESET to restore to the factory settings
No sound come out from the car speakers	<ol style="list-style-type: none"> <li>1.The speaker cable is not properly connected</li> <li>2.Not start up external amplifier of the car</li> <li>3.Making stereo in mute function when you press mute button</li> </ol>	<ol style="list-style-type: none"> <li>1.Re-connect the speaker cable properly</li> <li>2.To check stereo and the connection wire of external amplifier</li> <li>3.To turn off the MUTE function</li> </ol>
Cannot increase the volume	This machine is running in still, slow motion or frame by frame playback	There is no sound output in still slow motion
Particular speaker cannot output sound	Audio setup is not correct	Set the proper audio configuration
Stuck in boot logo (can not enter system)	System file collapsed	System file collapsed to re-install firmware of the system
Radio without good reception	<ol style="list-style-type: none"> <li>1.Not to plug or not plug well the radio antenna.</li> <li>2.Not to connect ANT wire or not correctly connect ANT wire</li> <li>3.The GPS signal in your area is weak</li> <li>4.AF/TA option turned on</li> </ol>	<ol style="list-style-type: none"> <li>1.To plug well the radio antenna and tightly</li> <li>2.To connect correctly</li> <li>3.To make radio in the place with stronger signal or to add an extra signal enhancer</li> <li>4.To turn off AF/TA option to search radio stations.</li> </ol>
Failed to receive GPS signal or to position accurately	<ol style="list-style-type: none"> <li>1.Not to connect GPS antenna or not connect it correctly</li> <li>2.The GPS signal in your area is weak</li> <li>3.GPS signal is affected by heavy rain and fog</li> <li>4.Car is plastered with metallic membrane which shields radio from receiving GPS signal</li> </ol>	<ol style="list-style-type: none"> <li>1.To make the screw between GPS antenna and radio tightly</li> <li>2.To drive your car in the place with stronger GPS signal</li> <li>3.To drive your car to a wide-open area</li> <li>4.To move GPS antenna to outside of the car to check</li> </ol>
Failed to save the operation record after unplugging car key	Red ACC and yellow B+ cable do not connect correctly	To reconnect red ACC and yellow B+ cable correctly
NO signal when reverse car with installed rear camera	<ol style="list-style-type: none"> <li>1.Reverse camera power supply wire have not been connected correctly</li> <li>2.Camera RCA video input connector has not connected to Camera IN port from the device correctly</li> </ol>	<ol style="list-style-type: none"> <li>1.To connect reverse camera power supply wire correctly</li> <li>2.To connect camera RCA video input connector to Camera IN port from the device correctly</li> </ol>
When the ignition switch is turned to the ON position (or to the ACC position) the player automatically switches on		This is a normal function