

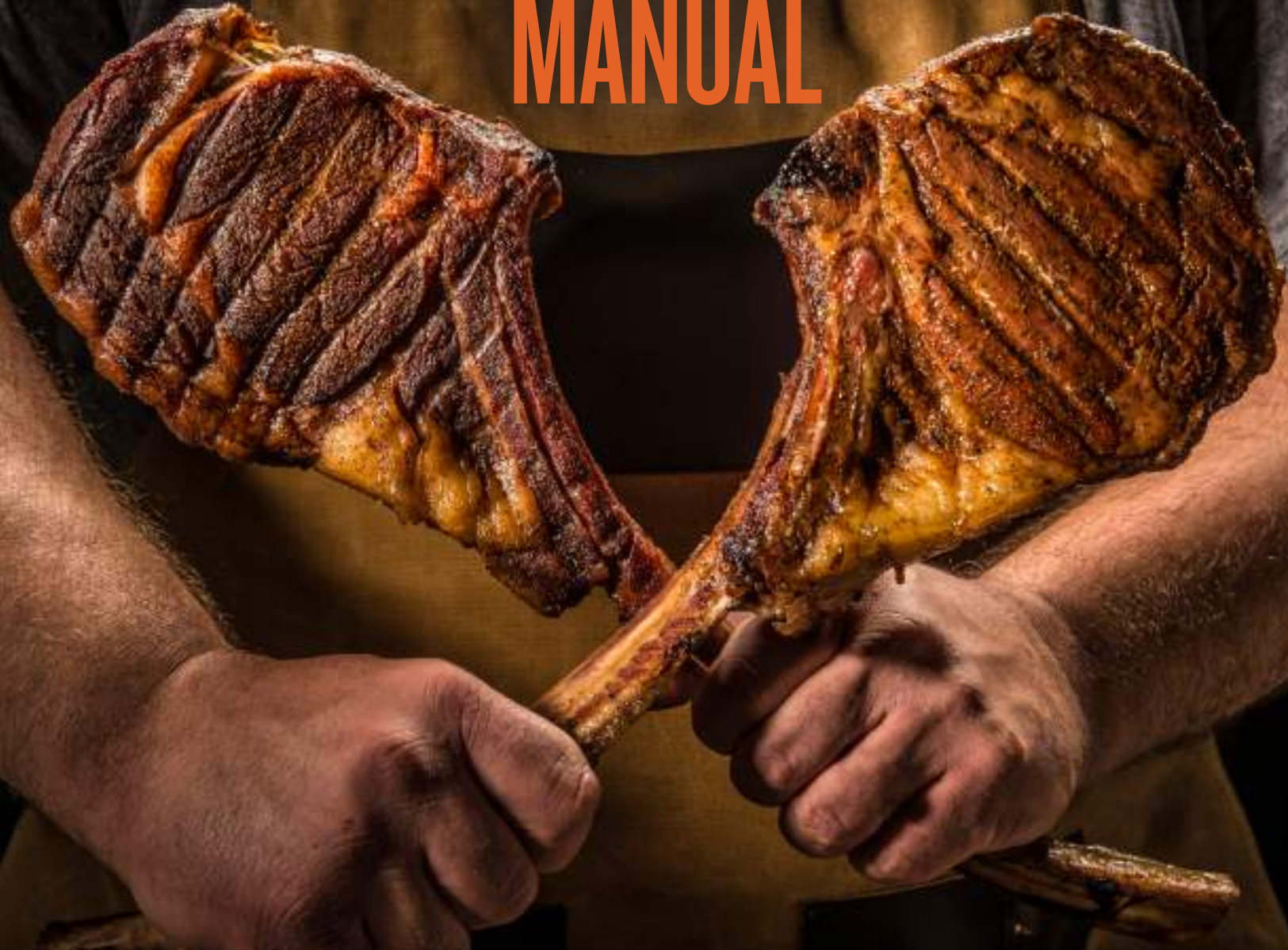

TRAEGER[®]
WOOD FIRED GRILLS

OWNER'S MANUAL



**WELCOME TO THE WOOD-FIRED REVOLUTION.
WE WANT YOU TO GET THE MOST OUT OF YOUR TRAEGER.**

Scan here to access this manual in different languages, as well as to learn how to set up, season, and get the most out of your grill.

Accessories Not Included
Accessoires non inclus
Accesorios no incluidos



**TFB88PUB/ZB/ZBO
TFB57PUB/ZB/ZBO**

ITM. / ART. 833853

IMPORTANT SAFETY PRECAUTIONS

READ ALL INSTRUCTIONS BEFORE INSTALLING AND USING YOUR TFB88/TFB57PUB TRAEGER® GRILL

A MAJOR CAUSE OF FIRES IS FAILURE TO MAINTAIN REQUIRED CLEARANCES (AIR SPACES) BETWEEN COMBUSTIBLE MATERIALS. IT IS OF UTMOST IMPORTANCE THAT THIS PRODUCT BE INSTALLED ONLY IN ACCORDANCE WITH THESE INSTRUCTIONS.

When properly operated and maintained, cooking with a hardwood fire on a Traeger® Grill brings years of enjoyment – to you and your lucky friends and family. Your new Traeger® Grill is specially designed to make cooking easier while giving you optimal performance with the most savory-flavored food.

Please read this entire manual before installation, and anyone who uses this grill should also read the entire manual before operating it. Failure to follow these instructions could result in property damage, bodily injury, or even death. Contact local building or fire officials about restrictions and installation inspection requirements in your area. **Save these instructions.** If you are assembling this unit for someone else, provide this manual for the owner to read and save for future reference.

⚠ DANGER Carbon Monoxide Hazard

Burning wood pellets produces carbon monoxide which may lead to illness, serious injury, and/or death. Follow these guidelines to prevent this colorless, odorless gas from poisoning you, your family, your pets, or others:

- Only use your Traeger® Grill outside in a well-ventilated area. This grill is intended for **OUTDOOR USE ONLY**.
- **Never** use your Traeger® Grill in any enclosed area or any area without adequate ventilation.
- Know the symptoms of carbon monoxide poisoning: headache, dizziness, weakness, nausea, vomiting, sleepiness, and confusion. Carbon monoxide reduces the blood's ability to carry oxygen. Low blood oxygen levels can result in loss of consciousness and death.
- See a doctor if you or others develop cold- or flu-like symptoms. Carbon monoxide poisoning, which can easily be mistaken for a cold or flu, is often detected too late.
- Alcohol consumption and drug use increase the effects of carbon monoxide poisoning.
- Carbon monoxide is especially toxic to mother and child during pregnancy, infants, the elderly, smokers, and people with blood or circulatory system problems, such as anemia or heart disease.

⚠ WARNING Fire Hazard

- When operating your Traeger® Grill, maintain a **MINIMUM** distance of 18 inches (45.7 cm) from the grill to any nearby combustibles, including wooden railings, home siding, window frames, furniture, trees, and trash receptacles, etc.

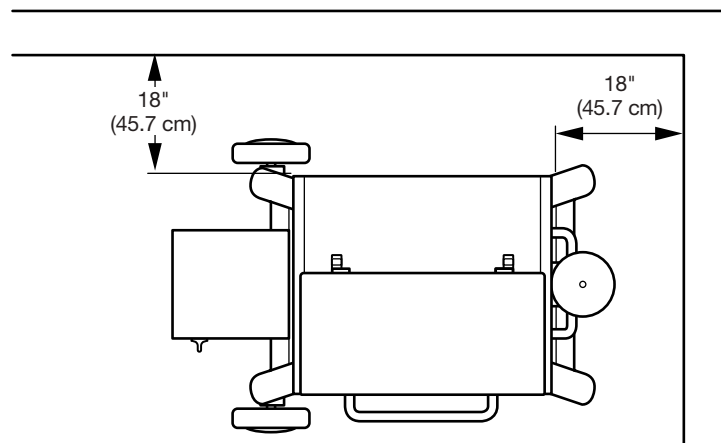

- Do not install or operate this grill indoors or under a combustible ceiling or overhang.
- Do not install or operate your Traeger® Grill on combustible floors or surfaces.
- Do not put a grill cover or anything flammable in the storage space area under the grill.
- Remove pots and pans while the operating appliance is unattended, to reduce the risk of fire.

⚠ WARNING Fire Hazard

- Keep your Traeger® Grill clean. Grease fires are caused by not properly maintaining your grill and failing to clean its Traeger® Grease Management System on a consistent basis (see “Maintaining Your Grill” on pages 23-24).
- Even if there is ample room in the grill, be cautious of loading excessive amounts of food or high-fat content foods (e.g., bacon) that can release large quantities of flammable grease.
- Do not place food near the edges of the grill where grease drippings may miss the grease drip tray and fall to the bottom of the grill where they could come into contact with embers from the firepot and ignite.
- Always make sure the heat baffle and drip tray are properly seated on its locating brackets. If not installed correctly, direct heat and flame from the firepot could cause a grease fire or damage the Traeger® Grease Management System.
- **Never** use gasoline, lantern fuel, kerosene, lighter fluid, or other flammable materials to start or “freshen up” a fire.
- **Never** use or store flammable liquids or other combustibles materials near the grill.
- **Never** attempt to over-fire your grill by adding excess pellets or other combustible materials to the firepot or the hopper.

⚠ DANGER In the event of a grease fire, ensure the grill door and hopper lid are closed, and then immediately unplug the grill if you can do so safely. Move away from the grill until the fire is completely out and grill has cooled down. Until the fire has extinguished and the grill has cooled off:

- **Do Not** move the grill;
- **Do Not** throw water on the grill; and
- **Do Not** try to smother the fire.

With the grill lid and hopper closed, the fire will be starved of oxygen and burn itself out. Never keep the grill lid or hopper lid open during a grease fire; if the grill door is open use a non-combustible tool that will allow you to close the grill door while keeping a safe distance from the grill. An all-class (class ABC) approved fire extinguisher should be used if a fire is not contained within the grill. If an uncontrolled fire does occur, immediately call the Fire Department.

When the fire is completely out, allow the grill to cool completely. Remove everything from the inside of your grill, including all internal components (grill grates, drip tray, and heat baffle), pots and pans, and food. Clean the entire grill, including any grease accumulation from

the Traeger® Grease Management System (TGMS) and all ash and pellets from the grill and firepot (see “Maintaining Your Grill” on pages 23-24. Replace the heat baffle, grease drip tray and grill grates, restart the grill, and resume cooking.

⚠ WARNING Fire Hazard

Always allow grill to cool completely before clearing the auger.

⚠ WARNING Burn Hazard

Ashes should always be completely cool before handling. Ashes should be placed in a metal container with a tight-fitting lid. The closed container of ashes should be placed on a noncombustible floor or on the ground, well away from all combustible materials, pending final disposal. Ashes should be retained in the closed container until they are disposed.

⚠ WARNING Burn Hazard

Many parts of the grill become very hot during operation. During operation of the grill and afterwards, care must be taken to avoid burns while the grill is hot.

- **Never** leave the grill unattended when young children or pets are present.
- **Never** move the grill when it is operating or hot. Let the grill cool thoroughly and close the grill door before moving or attempting to transport. If you are transporting your grill in a vehicle after cooking on it, make sure the fire is completely out and the grill is cold before placing it in any vehicle. Never put water into the firepot; it will jam the auger.
- **Never** add pellets by hand to a hot firepot. This is dangerous and you may be seriously burned. If you run out of pellets and lose your fire while cooking, let the grill cool completely and start again. (See page 22, “Hopper Clean-out” instructions).
- **Never** move the grill with the lid open. Always close the grill lid prior to moving.

⚠ WARNING Smoke Hazard

- If there is a delayed start and the smoke from your grill changes from transparent, white smoke to unusual billowing thick, non-transparent, white smoke that turns to a yellow-tinted smoke, immediately turn off your grill using the main power switch on the back of the pellet hopper or unplug the power cord. **Do Not** initiate the shut-down cycle.
- **⚠ DANGER Do Not** open the grill door to air out the grill. Stay away from the grill until smoke clears and the grill completely cools.

IMPORTANT SAFETY PRECAUTIONS (CONTINUED)

- This may be the result of a pellet overflow condition, which is caused by partial ignition of pellets. If allowed to continue long enough, gases will build up, which can ignite. If these gases ignite they will combust all at once, making a loud noise that may startle and/or injure persons in the immediate vicinity of the grill, and the grill door may open and close. This occurrence is sometimes referred to as a “grill burp” and should be avoided. If you have not properly maintained your grill, as described in “Maintaining Your Grill” on pages 23-24, a hazardous grease fire may also result.
- If a burp occurs, let the grill cool down completely, remove all internal components (including grill grates, drip tray, and heat baffle), and thoroughly clean all ash and pellets from the grill and firepot (see page 24, “Cleaning the Ash from Inside and Around the Firepot”) and ensure that grease and other buildup has been removed (see pages 23-24, “Maintaining Your Grill”). Remove all pellets from the pellet hopper. Run the prime auger sequence to push all pellets out of the auger and dispose of those pellets. Clean all pellets out of the firepot. Fill hopper with new pellets and prime the auger (see “Seasoning Your Grill” on page 13 for instructions to prime your auger).

▲ DANGER Do Not stick your hand in or near the auger located at the bottom of your pellet hopper. Severe injury will occur if the auger is turning and your hand is caught in the auger. Do not remove the honeycomb guard in your pellet hopper. No maintenance should be performed on or around the auger while the grill is turned on or plugged into power.

▲ WARNING Electrical Shock Hazard

Hazardous voltage is present, which can shock, burn, or cause death.

- Ground Fault Circuit Interrupter (GFCI) protection must be provided on the circuit(s) or outlet(s) to be used for the operation of this Traeger® Grill.
- Disconnect the power cord before servicing the grill unless otherwise noted in this Owner’s Manual.
- If using an extension cord, only use an extension cord suitable for outdoor use to prevent electric shock in accordance with the instructions and warnings accompanying that product. This type of cord is designated with “W-A” or “W” on the cord’s jacket such as an extension cord of cord type: SW-A, SOW-A, STW-A, STOW-A, SJW-A, SJOW-A, SJTW-A, or SJTOW-A.
- If using an extension cord, be sure to use a No. 14 AWG grounded extension cord.
- Do not modify the plug on your Traeger® Grill, the extension cord receptacle, or the extension cord plug in any way, including by removing the ground (earth) prong.
- Make sure your extension cord is in good condition. Inspect extension cords prior to each use for loose or exposed wires and cut or worn insulation. Replace if damaged. Never use a damaged extension cord.
- Ensure that the power cord and extension cord are securely plugged together. Do not plug extension cords into one another.
- Keep extension cord clear of snow and standing water.
- Ensure that the power cord and extension cord do not create a tripping hazard. Do not route an extension cord through a window or doorway.
- When not in use, the extension cord should be removed and stored in a location protected from the sun and out of the reach of children.

▲ CAUTION

- Never modify this grill or install any parts or components not authorized by Traeger for use with this grill. Any modification of this grill or installation of unauthorized parts or components will void the warranty and may create a safety hazard including, without limitation, a fire.
- Children should be supervised to ensure they do not play with the grill.
- Do not put a grill cover or anything flammable in the storage space area under the grill.

▲ CAUTION Use Correct Pellets

- This grill is designed and approved only for all natural wood cooking pellets designed for wood pellet grills. Use of any other type of fuel in this grill will void the warranty, may lead to the auger becoming jammed, and may create a safety hazard.
- **For best results and flavor, use genuine TRAEGER® BRAND HARDWOOD PELLETS.**
- Always store wood pellets in a dry location, away from heat-producing appliances and other fuel containers.

▲ WARNING DO NOT USE FUEL PELLETS. Never use heating fuel pellets in the grill because they may contain hazardous contaminants and additives and may damage the grill.

⚠ CAUTION Minimum Ambient Temperature

- When the ambient temperature falls below -20°F (-29°C) damage to the controller's display may occur.

⚠ WARNING If the fire in the firepot goes out while cooking, it is important to follow these steps. Failure to do so may cause a hazardous “overfiring” of your grill due to an excess of unburned pellets in the firepot. This is often caused by improper startup procedure and/or running out of pellets.

- Turn the main power switch at the back of the grill hopper to OFF (O) and disconnect the power cord. Allow the grill to cool thoroughly. Open the door and remove all food, grill grates, drip tray, and heat baffle.
- Remove all unburned pellets and ash from inside and around the firepot. (See instructions for proper handling and disposal of ash on page 24.)
- Before replacing the heat baffle, drip tray, and the grill grates, plug the power cord into an appropriate grounded/earthed electrical outlet and turn the switch ON (I). Pellets should fall into the firepot and the hot rod should begin to heat (it will start to turn red).

⚠ CAUTION Do not touch the hot rod.

- When flames start to come out of the firepot, turn the switch OFF (O). Let the grill cool down. Now you're ready to place the heat baffle, grease drip tray, grill grates, and food back into the grill.
- Accumulated grease is easier to clean off when the grill is still warm—not hot. **Be careful not to burn yourself. Heat-protective gloves are recommended.**
- A dedicated vacuum cleaner is the best way to remove ashes from the firepot, but this must be done with extreme care to avoid the risk of fire. Again, cleaning the ash from in and around the firepot should be done only when the grill is COLD.
- Cleaning the grill grates works best while they are still warm. **Be careful not to burn yourself. Heat-protective gloves are recommended.** We recommend keeping a long-handled cleaning brush near the grill. After removing your food, give the grill grate a quick brushing. It takes only a minute and it will be ready the next time you want to use the grill.

SAVE THESE INSTRUCTIONS

LIVE FLAVOR FULL

UNLOCK THE FULL POWER OF YOUR GRILL
WITH THE TRAEGER APP

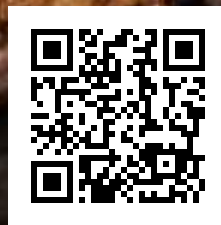



TABLE OF CONTENTS

2	IMPORTANT SAFETY PRECAUTIONS
8	FLAVOR MATTERS
9	ALL NATURAL HARDWOOD PELLETS
10	GETTING TO KNOW YOUR GRILL
13	SEASONING YOUR GRILL
15	USING YOUR GRILL
20	USING THE MEAT PROBE
21	ADDITIONAL CONTROL FUNCTIONS
22	HOPPER CLEAN-OUT
23	MAINTAINING YOUR GRILL
25	FREQUENTLY ASKED QUESTIONS
27	OPERATING TIPS
28	ACCESSORIES
29	SERVICE
30	TRAEGER® GRILL WARRANTY

FLAVOR MATTERS. WOOD ISN'T JUST THE FUEL, IT'S THE **SECRET INGREDIENT.**

TRAEGER HARDWOOD	GOOD FOR ANYTHING GREAT FOR:					
APPLE						
CHERRY						
HICKORY						
MESQUITE						
PECAN						
SIGNATURE BLEND						

THE PERFECT **PAIRINGS**



Bold cuts of beef need bold wood flavors to match, like hickory or mesquite.



Throw in some pellets and turn your Traeger into a wood-fired pizza oven.



Cherry pie cooked over fruit hardwood pellets? Yes please.

NO FILLERS
BINDERS
NO WORRIES



MADE IN THE U.S.A.

ALL NATURAL HARDWOOD PELLETS

CONSISTENT PERFORMANCE & FLAVOR

HOW OUR PELLETS ARE MADE



1 Traeger pellets are made from **all natural hardwood** sawdust.



2 The sawdust is compressed into pellets using **heat and pressure**.



3 Pellets **fuel the fire and add flavor** to make meals unforgettable.

GETTING TO KNOW YOUR GRILL

Refer to the Assembly Guide to assemble and install your Traeger® Pro Series Grill.

GRILL PARTS AND FEATURES

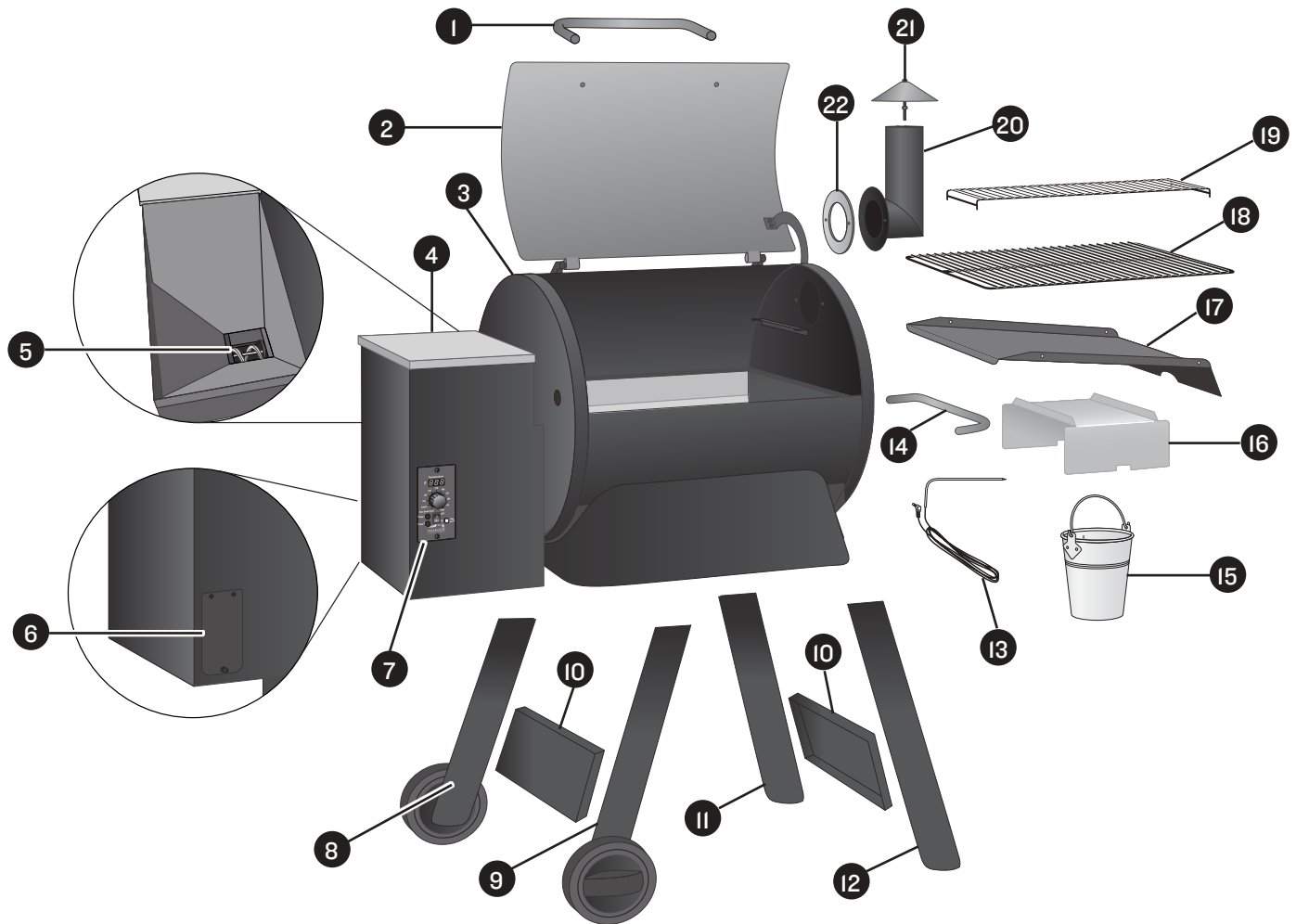

Part	Description
1	Grill Door Handle
2	Grill Door
3	Grill Barrel
4	Pellet Hopper
5	Auger (Pellet Hopper Interior)
6	Pellet Hopper Clean-out Door
7	Digital Pro Controller
8	Rear Wheeled Leg
9	Front Wheeled Leg
10	Leg Braces
11	Rear Fixed Leg

Part	Description
12	Front Fixed Leg
13	Meat Probe
14	Side Lift Handle
15	Grease Bucket
16	Heat Baffle
17	Grease Drip Tray
18	Porcelain-Coated Grill Grate
19	Extra Grill Rack
20	Chimney Pipe
21	Chimney Cap
22	Chimney Pipe Gasket



PELLET HOPPER

An 18 lb. (8.2 kg) capacity pellet hopper will keep you cooking for hours. Pair that with Traeger's Digital Pro Controller and delicious food is just a "click" away.

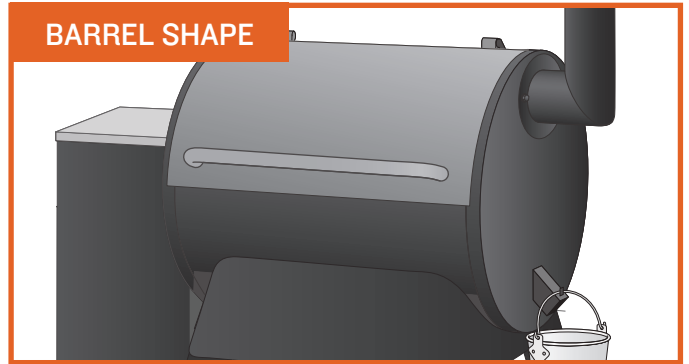

BARREL SHAPE

Traeger's signature barrel shape creates a vortex of convection. It circulates hot, smoky air around the cooking chamber, surrounding your food with wood-fired heat for even cooking on all sides.

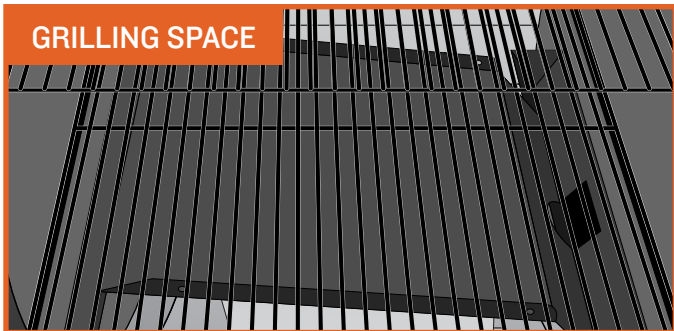

GRILLING SPACE

With either 884 sq. in. (0.57 m²) (Pro Series 34) or 572 sq. in. (0.37 m²) (Pro Series 22) of grilling space and up to 76,000 BTUs of wood-fired heat, your Traeger® Grill has the real estate and cooking power for party-sized orders of T-bones or racks of ribs, with enough room left over to handle various side dishes, too.

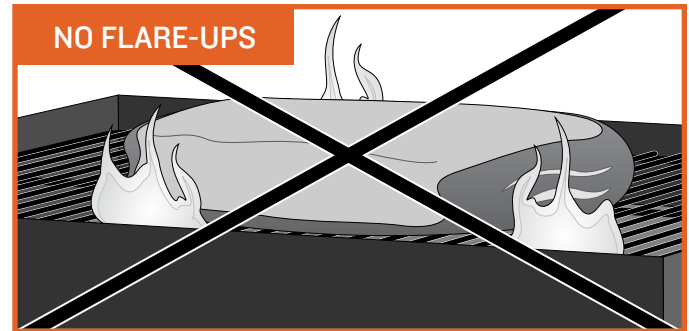

NO FLARE-UPS

You don't have to worry about drippings flaring up and causing nasty fireballs that destroy your meal because Traeger® Wood Fired Grills cook by using indirect heat. All drippings are safely channeled into an external grease bucket for easy disposal.

TIP: Take care of your Traeger® Grill by using a new Traeger drip tray liner before each cook to help keep your grill clean.

WARNING! Keep your grill clean. See "Operating Tips" (page 27) and "Maintaining Your Grill" (pages 23-24).

GETTING TO KNOW YOUR GRILL (CONTINUED)

Before you begin using the grill, it will be helpful to familiarize yourself with the different features of the Digital Pro Controller.



- 1 TEMPERATURE DIAL**
Rotate dial to set the desired temperature.
- 2 TEMPERATURE DISPLAY**
Shows current temperature, error codes, and probe selection.
- 3 MAIN POWER SWITCH**
Press to turn power to the grill on or off.
- 4 PROBE SELECTOR**
Press to display probe temperature.

NOTES:

- Temperature fluctuations are normal for Traeger® Grills. Any significant fluctuation could be the result of wind, air temperature, improper use, or lack of grill maintenance.
- Consider purchasing a Grill Insulation Blanket for your grill for winter grilling in below-freezing conditions to help save on pellets.

SEASONING YOUR GRILL

TO BE USED ON INITIAL FIRING ONLY. In order to ensure proper and safe operation of the grill, follow the instructions below first, to prime the auger (“charge” the auger tube with pellets) and, second, to season your grill (run your grill at a high temperature).

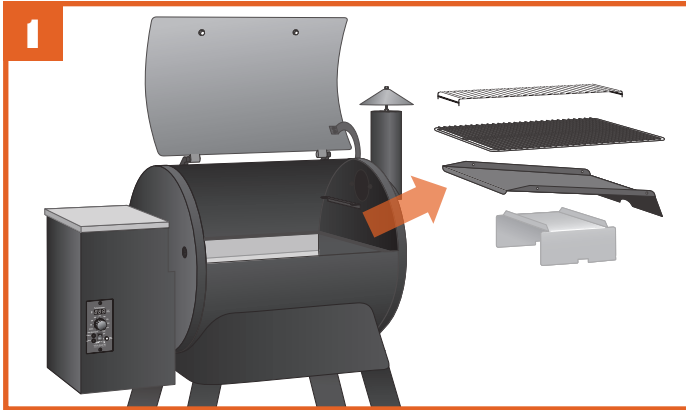

Remove the grill grates, grease drip tray, and heat baffle from the inside of the grill.

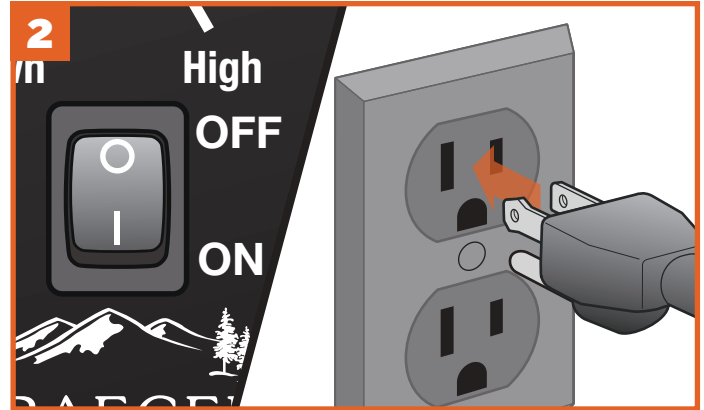

PLUG APPEARANCE MAY VARY BY REGION.



WARNING! Ground Fault Circuit Interrupter (GFCI) protection must be provided on the circuit or outlet used to power the grill.

With the main power switch on the back of the grill hopper in the OFF (O) position, plug the power cord into an appropriate grounded/earthed GFCI electrical outlet.

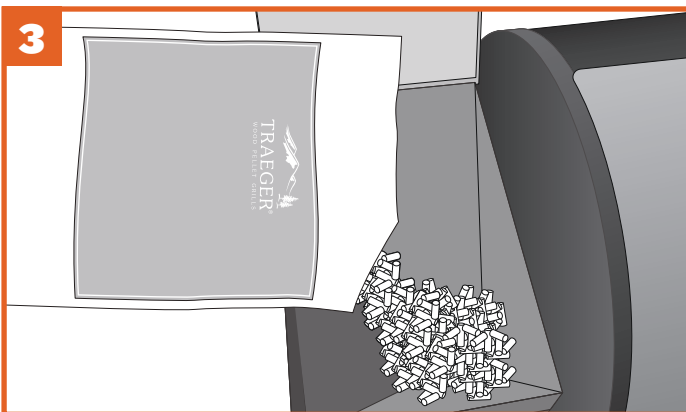

Open the hopper lid. Make sure there are no foreign objects in the auger before adding pellets to the hopper. After adding pellets to the hopper, close the hopper lid. We recommend you fill the hopper with pellets at least to the safety grate in the hopper.



WARNING! DO NOT USE FUEL PELLETS. Never use heating fuel pellets in the grill because they may contain hazardous contaminants and additives and may damage the grill.



Turn grill on: Flip the main power switch to ON (I) and turn the temperature dial to SMOKE. Look inside the firepot to make sure the auger is turning (inside the pellet hopper).

SEASONING YOUR GRILL (CONTINUED)

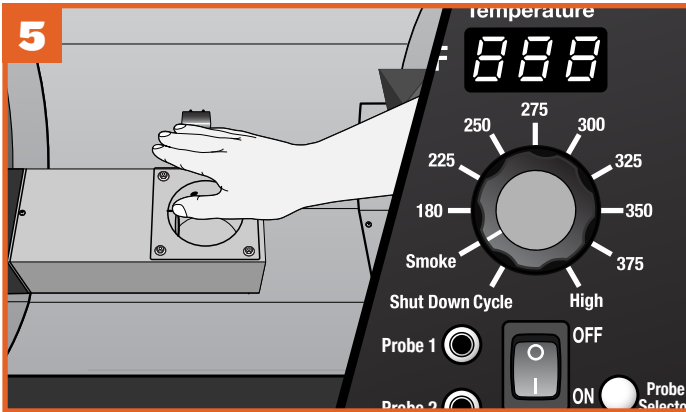

Check that there is air movement from the draft inducer fan by placing your fingers over the firepot. If the hot rod is getting hot, it will turn red.



CAUTION! Do not touch the hot rod.

Place the heat baffle, grease drip tray, and grill grates back into the grill.

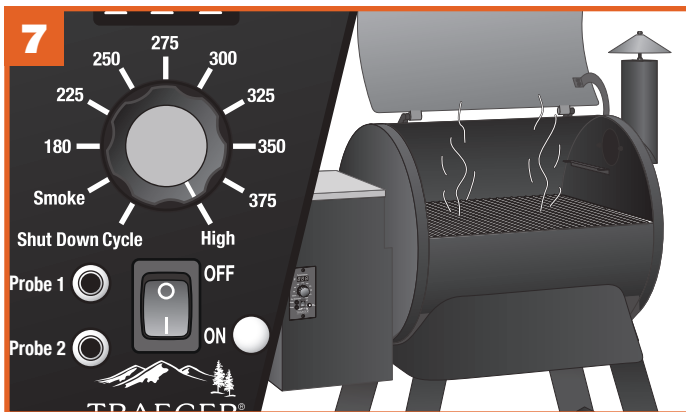

With the main power switch in the ON (I) position, turn the temperature dial to HIGH. In about two minutes the pellets will ignite and whitish-gray smoke will come out of the grill.



Turn the temperature dial to HIGH. Once pellets begin to fall into the firepot, the auger is primed. Turn the dial to SHUT DOWN CYCLE to reset the ignition process.

NOTE: During the initial charging of the auger, it will take time for the pellets to move from the pellet hopper to the firepot (2-4 minutes).

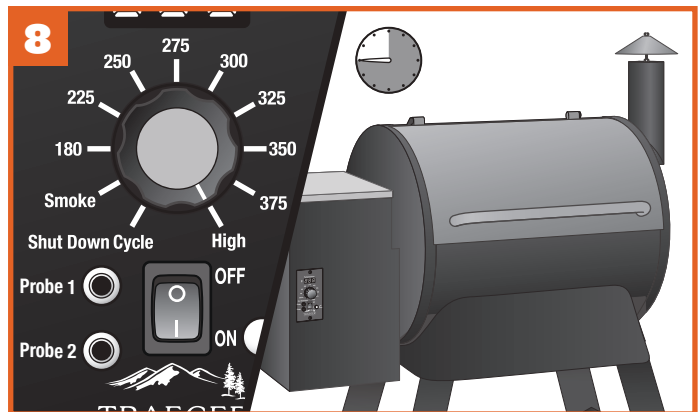

Before using your grill for the first time, it will need to be seasoned. Turn the temperature dial to HIGH and let run for 45 minutes with the door closed. After seasoning, turn the dial to SHUT DOWN CYCLE and allow the grill to run through its complete shut down cycle. Your grill is now ready to cook.

NOTE: Always run your grill through the full shut-down cycle after each cooking task. To initiate this cycle, turn the temperature dial to SHUT DOWN CYCLE.

USING YOUR GRILL

YOU WILL NEED TO BEGIN WITH THESE STEPS EVERY TIME YOU USE YOUR GRILL.

PRE-GRILLING CHECKLIST

1. Check for and do needed maintenance:
 - Clean the Traeger Grease Management System:
 - Grill Grates
 - Drip Tray
 - Grease Trough
 - Grease Chute
 - Grease Bucket
 - Remove ash (after approximately 20 hours of cooking).
 - Check power cord for twists, damage or fraying.
2. Make sure grill is correctly assembled with all parts present before using grill:
 - Heat Baffle
 - Drip Tray
 - Grill Grates
3. Make sure you have proper airflow:
 - Chimney
4. Make sure grill is a safe distance from combustibles (see page 2).
5. Make sure grill is on a level surface.
6. Inspect pellets:
 - Make sure you have enough pellets in the hopper.
 - Make sure the pellets are not wet, water damaged, swollen, or dull. They should be shiny and easy to snap.
 - Make sure the bottom of the hopper and the auger do not have excessive sawdust.
7. Close the hopper lid.
8. Close grill door.

START-UP

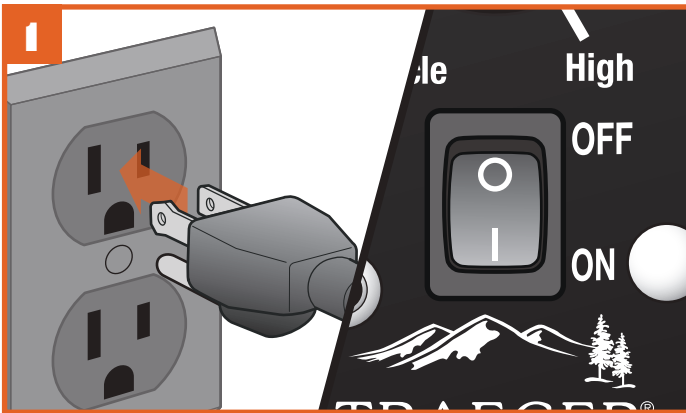

PLUG APPEARANCE MAY VARY BY REGION.

WARNING! Ground Fault Circuit Interrupter (GFCI) protection must be provided on the circuit or outlet used to power the grill.

WARNING!

- When operating this grill, maintain a minimum clearance of 18 inches (45.7 cm) from grill to combustibles, such as wooden railings or home siding.
- Never operate this grill under a combustible ceiling or overhang.
- Only operate grill outdoors.
- **DO NOT USE FUEL PELLETS.** Never use heating fuel pellets in the grill because they may contain hazardous contaminants and additives and may damage the grill.

USING YOUR GRILL (CONTINUED)

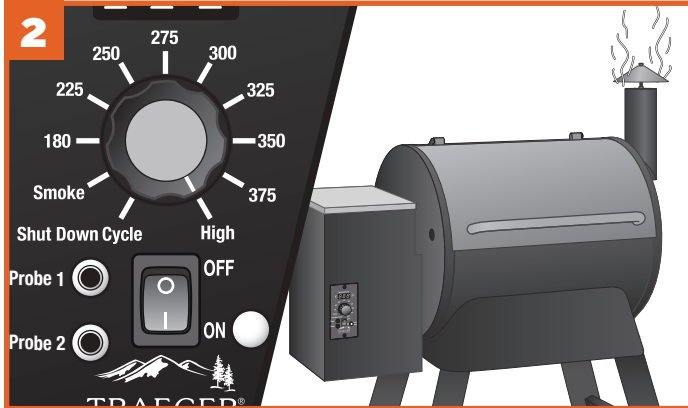

Close the grill door. Turn the temperature dial to your desired temperature. After two minutes pellets will begin to ignite and whitish-gray smoke will come out of the grill. For best results, allow the grill to preheat for 10 minutes with the door closed before placing food in the grill.

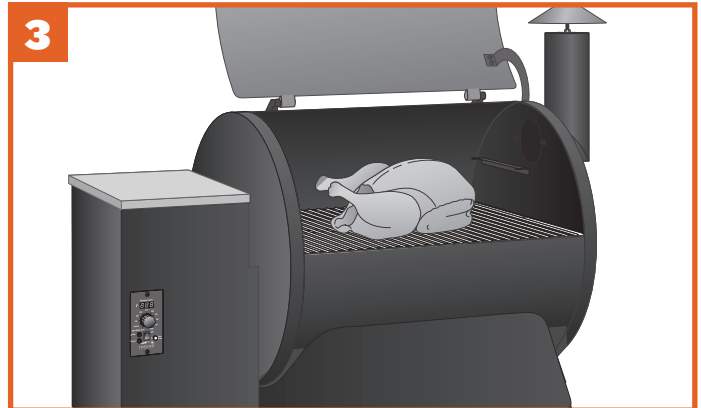

Once preheating is complete, load food into the grill. See page 20 if using the meat probe prior to loading food into the grill.



WARNING! We recommend you clean the grease drip tray and TGMS frequently to reduce the possibility of a grease fire. Please see “Maintaining Your Grill” on pages 23-24 for more details.

NOTE: Always run your grill through the full shut-down cycle after each cooking task. Turn the temperature dial to SHUT DOWN CYCLE to initiate the shut down cycle.

TIPS:

- It is recommended, but not necessary, to wait until the preheat cycle is complete before loading food into the grill. Doing this can result in the grill taking longer than usual to achieve desired temperature.
- Keep the grill door closed during the preheat cycle so that the grill can reach the desired set temperature.
- Traeger® Grills provide real time temperature readings and you should expect to see fluctuations in temperature.

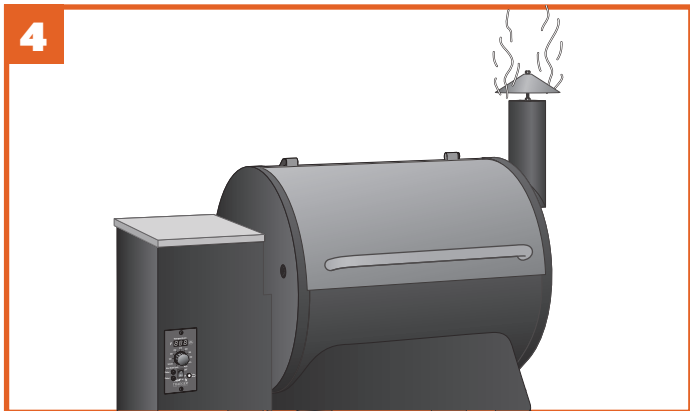

Close the grill door to proceed with cooking. Unlike a gas grill, you must keep the grill door shut during cooking.

IN CASE OF FIRE:



WARNING! With regular maintenance and cleaning of your Traeger® Grill, a grease fire is unlikely. In the unlikely event of fire, immediately turn the grill OFF (⓪) and leave the grill door closed until the fire is out. Do not unplug the power cord. Do not throw water on the unit. Do not try to smother the fire. With the grill door closed, the fire will be starved of oxygen and burn itself out. If an uncontrolled fire does occur, call the Fire Department.

USING YOUR GRILL (CONTINUED)

REIGNITING YOUR GRILL



WARNING! If at any time the grill fails to light or the fire in the firepot goes out while cooking or smoking and there are sufficient pellets in the pellet hopper, it is important to follow these steps. Failure to do so may cause a hazardous “overfiring” of your grill due to an excess of unburned pellets in the firepot.

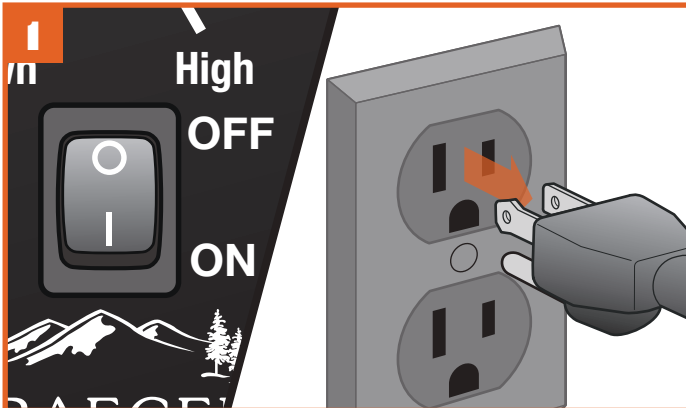

DANGER! If the grill failed to light or the fire went out, turn the main power switch OFF (O) and disconnect the power cord. If the grill is still hot, allow it to cool thoroughly.

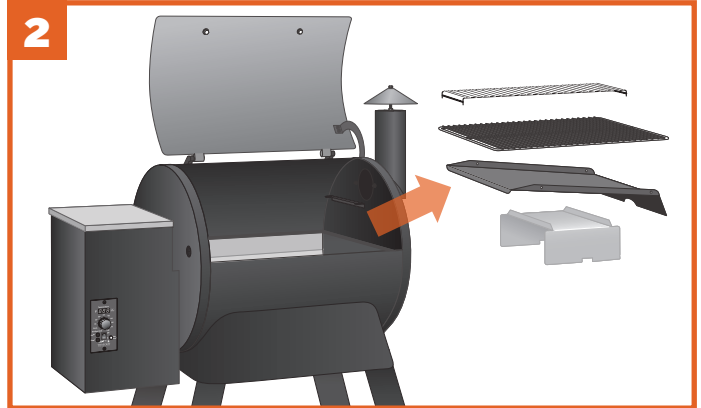

Open the door and remove all food, the porcelain-coated grill grates, the grease drip tray, and the heat baffle.

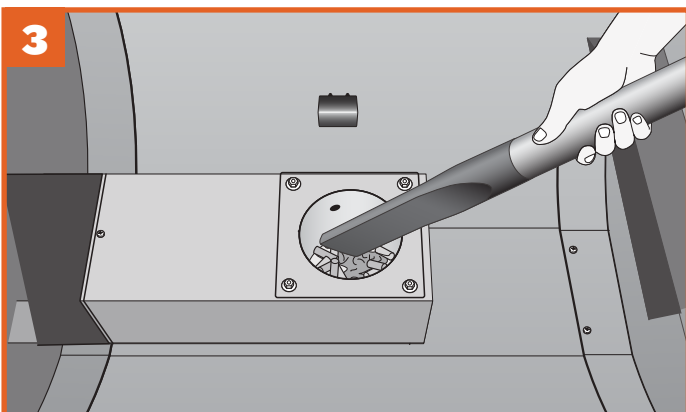

WARNING! After the grill, pellets, and ash have completely cooled, remove all unburned pellets and ash from inside and around the firepot. (See instructions for proper handling and disposal of ash on page 24.)

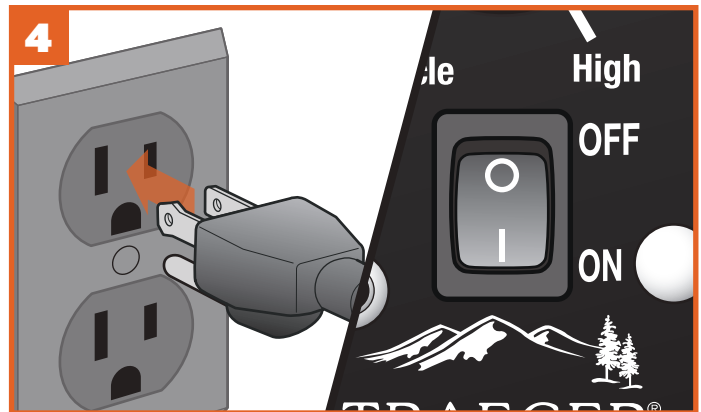

Plug power cord into an appropriate grounded electrical outlet and restart the grill. Pellets should fall into the firepot and the hot rod should begin to heat (it will start to turn red).



CAUTION! Do not touch the hot rod.

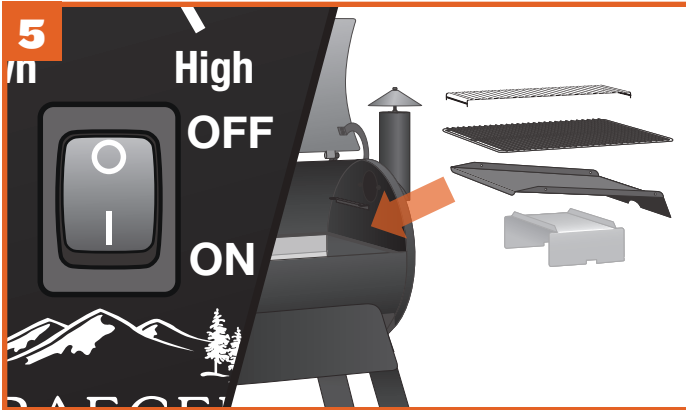

When flames start to come out of the firepot, turn the main power switch OFF (0). Let the grill completely cool. Place the heat baffle, grease drip tray, and grill grates back into the grill.

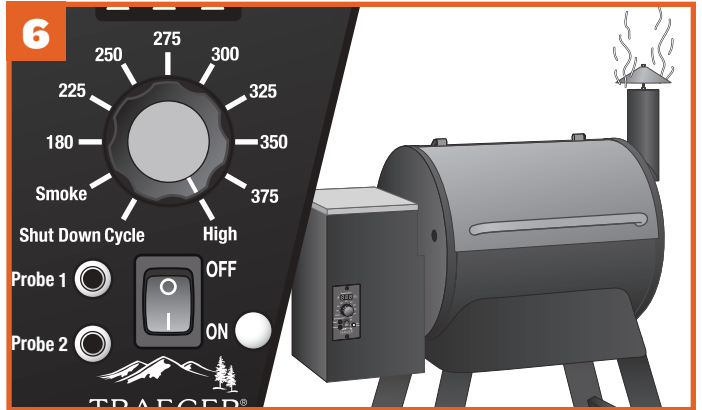

Turn the temperature dial to your desired temperature. After two minutes pellets will begin to ignite and whitish-gray smoke will come out of the grill. For best results, allow the grill to preheat for 10 minutes with the door closed before placing food in the grill.

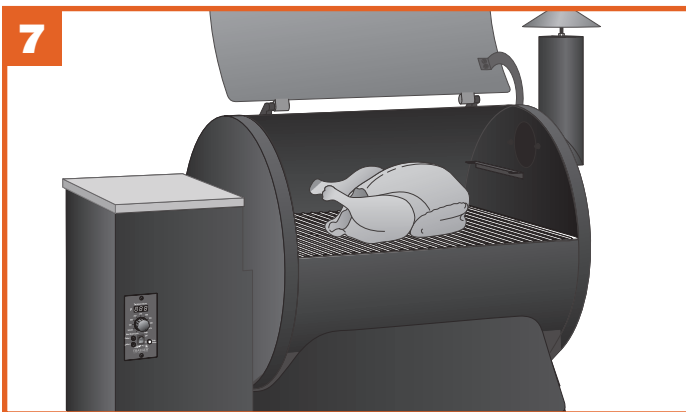

Once preheating is complete, load food into the grill. See page 20 if using the meat probe prior to loading food into the grill. Close the grill door to proceed with cooking. Unlike a gas grill, you must keep the grill door shut during cooking.

IN CASE OF FIRE:



WARNING! With regular maintenance and cleaning of your Traeger® Grill, a grease fire is unlikely. In the unlikely event of fire, immediately turn the grill OFF (0) and leave the grill door closed until the fire is out. Do not unplug the power cord. Do not throw water on the unit. Do not try to smother the fire. With the grill door closed, the fire will be starved of oxygen and burn itself out. If an uncontrolled fire does occur, call the Fire Department.

USING THE MEAT PROBE

Your Traeger® Pro Series Grill includes a meat probe for when your recipe specifies an internal goal temperature for your food. Additional probes can be purchased separately.

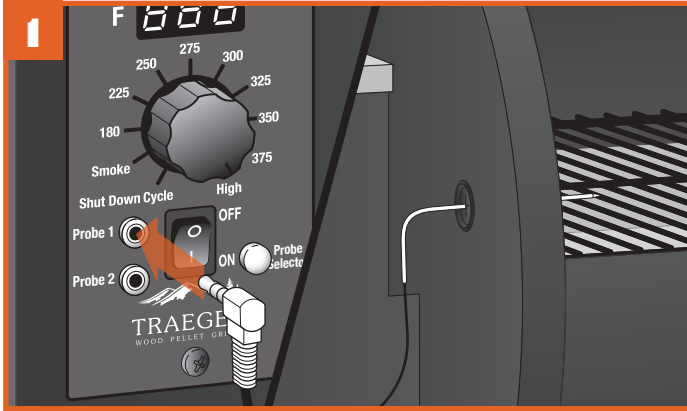

Insert 1 or 2 meat probes into the plug-in holes on the lower left corner of the controller; then thread probes through the access hole grommet on the left side of the grill barrel.

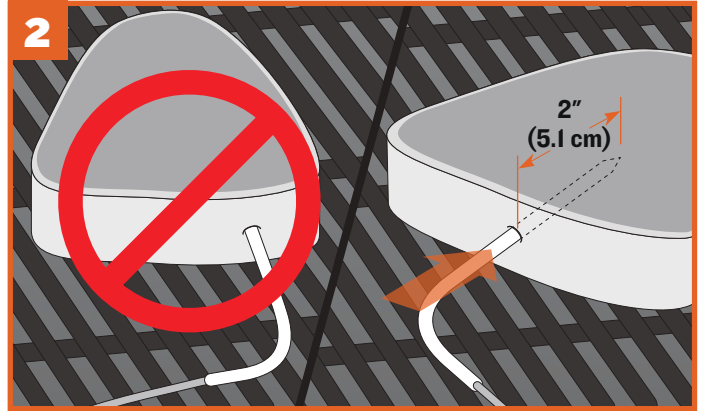

Insert the probe tip into the thickest part of the meat—not in the fatty portion or touching bone. The probe needs to be in the meat at least 2" (5.1 cm). This probe may not be suitable if you can't insert the probe into the thickest part of the meat and 2" (5.1 cm) into the meat.

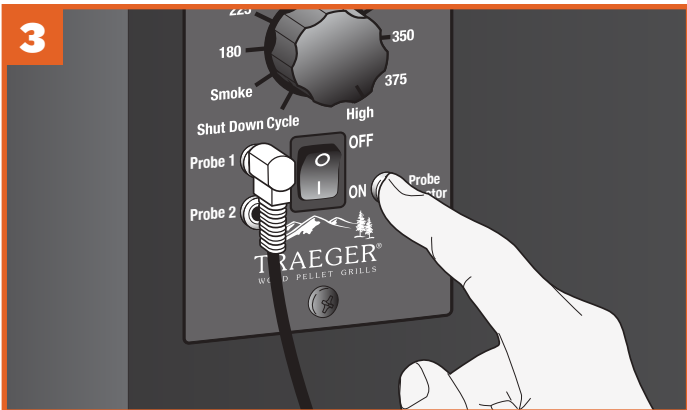

Reading the temperature: Press the probe selector switch on the controller. The probe temperature will display for 5 seconds, then revert back to the temperature of the grill. After removing your food from the grill, always use a meat thermometer to confirm that you have actually achieved the target internal meat temperature.

! WARNING!

- Meat probe is extremely hot during and after cooking. Use caution when removing.
- Improper placement of the meat probe or improper meat probe calibration could result in raw or undercooked meats, poultry, seafood, shellfish, or eggs, which may increase your risk of foodborne illness.

! WARNING! Consuming raw or undercooked meats, poultry, seafood, shellfish, or eggs may increase your risk of foodborne illness.

MEAT TEMPERATURE RECOMMENDATIONS

RANGE	BEEF	LAMB	PORK	POULTRY
Well	170°F/77°C	160°F/71°C	170°F/77°C	170°F/77°C
Medium	160°F/71°C	155°F/68°C	160°F/71°C	170°F/77°C
Medium Rare	145°F/63°C	145°F/63°C		170°F/77°C
Rare	135°F/57°C			170°F/77°C

ADDITIONAL CONTROL FUNCTIONS

CONTROL SHUT DOWN CYCLE The control for this grill comes with an automatic shut-down cycle. When finished cooking on your grill, set the temperature dial to the SHUT DOWN CYCLE position. This will leave the draft induction fan running for 10 minutes to burn any excess pellets in the firepot. After 10 minutes, the control will power off and the fan will stop running.



DANGER! The main power switch will shut off power to the control, and the temperature dial switch will shut off power to the grill components only. When servicing the control or any other parts, ensure that the power supply is disconnected to avoid an electrical shock hazard.

CONTROL SAFETY FEATURES

The control comes equipped with two safety features that will help you keep the grill operating correctly.

LOW TEMPERATURE ALARM

If the grill stays below 120°F (49°C) as read by the RTD temperature sensor for a period of 10 minutes, the control will go into an alarm state and the display will read “LeR.” This will turn off all power to the internal components of the grill. The display will stay in this state until you turn off the main power switch. If this condition was caused from running out of pellets, add pellets to the hopper and re-prime your auger.

HIGH TEMPERATURE ALARM

If the grill reaches an internal temperature reading of 550°F (288°C) as read by the RTD temperature sensor, the control will go into alarm state and the display will read “HeR.” This will turn off all power to the internal components of the grill. The display will stay in this state until you turn off the main power switch.

Whenever either of these alarm conditions occurs, let the grill cool down completely, remove all internal components, and thoroughly clean all ash and pellets from the grill body and firepot (see page 24, “Cleaning the Ash from Inside and Around the Firepot”). Contact Traeger Technical Support if you need help (see page 29).

HOPPER CLEAN-OUT

Your Traeger® Grill has a hopper clean-out system that allows you to remove pellets from the pellet hopper or quickly change from one pellet flavor to another without making a mess.

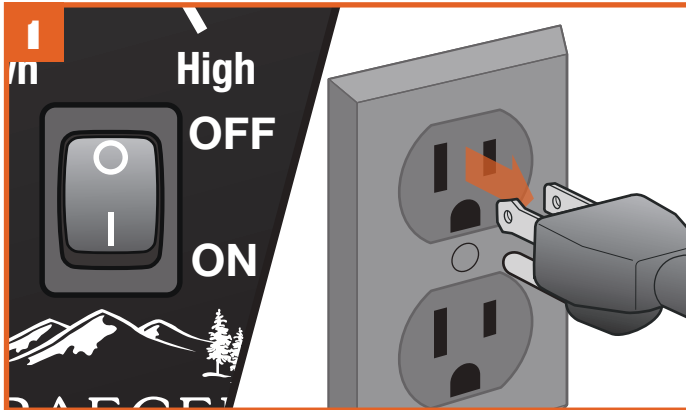

PLUG APPEARANCE MAY VARY BY REGION.

Turn the main power switch to OFF (0) and disconnect the power cord. If the grill is still hot, allow it to cool completely.

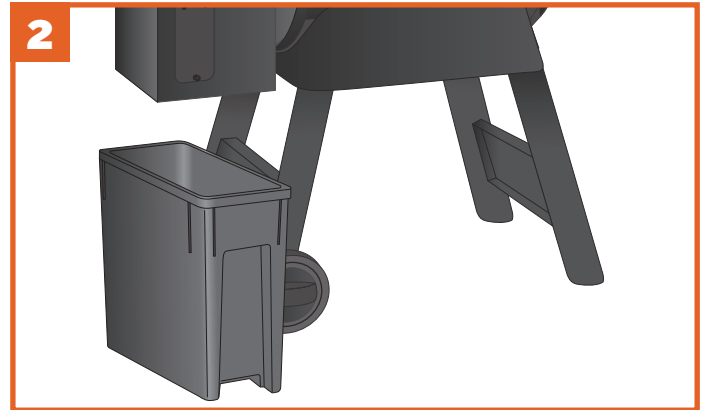

Place the Pellet Bin (purchased separately) to hold the unused pellets under the pellet hopper clean-out door.

TIP: A clean 5-gallon (19-liter) bucket also works great!

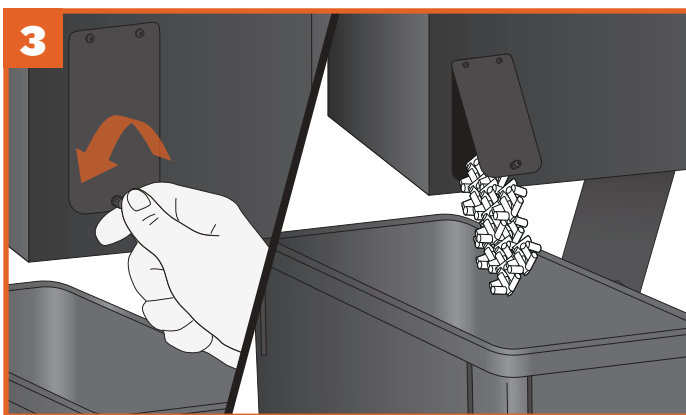

Unscrew the clean-out door fastener and open it. Pellets will empty into the Pellet Bin you've placed below. You might need a spatula or spoon to push the remaining pellets out of the hopper.

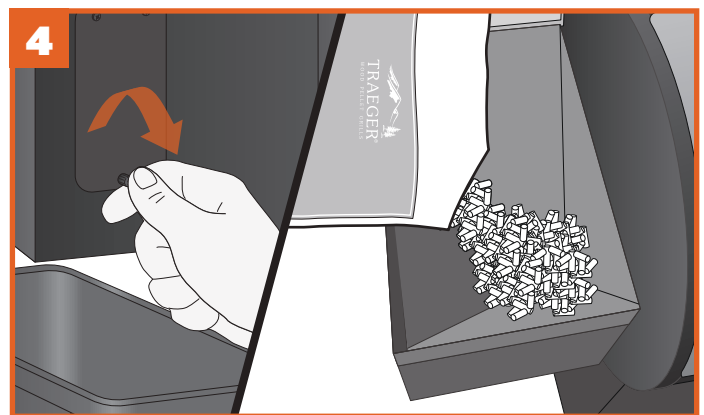

Once the hopper is empty, close the clean-out door, replace the fastener, and refill the hopper with your preferred flavor of TRAEGER® BRAND HARDWOOD PELLETS.



WARNING! Do not empty out the hopper until grill has completely cooled, otherwise pellets may be very hot.

MAINTAINING YOUR GRILL

▲ WARNING Fire Hazard: Grease fires are most frequently caused by failing to properly maintain the grill by not cleaning the grease from the unit on a consistent basis.

▲ WARNING Turn the main power switch on back of the grill hopper OFF (O) and disconnect the power cord before initiating any of the maintenance below.

1. CLEANING YOUR TRAEGER GREASE MANAGEMENT SYSTEM (“TGMS”):

During your cooks, grease drippings will fall onto (i) the grease drip tray and be channeled into (ii) the grease drain (the “Trough”) and then out of the grill through (iii) the grease drain tube, (iv) to be collected in the grease bucket. These four components are the components of the Traeger® Grease Management System (TGMS). Grease will accumulate in all of these locations and should be regularly cleaned to reduce the risk of fire.

How often you need to clean the TGMS depends on the fat content of your food. Fattier foods will require cleaning of the TGMS more often, and sometimes you will need to clean the TGMS after every cook.

Visible pieces of food and bits of hardened grease or other buildup indicate a need for cleaning.

All components of the TGMS should be inspected before each use for signs of grease buildup.

▲ CAUTION Accumulated grease is easier to clean off when the grill is still warm—not hot. **Be careful not to burn yourself. Heat-protective gloves are recommended.**

Clean the grease out of the V-shaped grease drain (the “Trough”) and grease drain tube. We recommend cleaning these locations regularly.

Remove all grill grates, grease drip tray, and heat baffle. This will provide access to the V-shaped grease drain and grease drain tube opening inside the grill. Scrape the grease accumulation from inside the V-shaped grease drain and grease drain tube using a stiff, nonmetallic tool. Much of the loosened grease can be pushed down through the grease drain tube and will fall into the grease bucket. Wipe up remaining grease residue with paper towels or disposable rags.

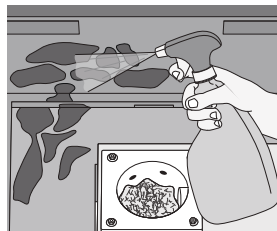

Regularly clean the grease out of the grill barrel on the interior bottom and sides. If grease is allowed to build up, a grease fire could result.

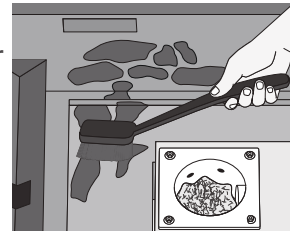

Scrape the grease accumulation from inside the barrel using a stiff, nonmetallic tool. Much of the loosened grease can be removed using paper towels or disposable rags. Excessive scraped-off residue can be cleaned using a vacuum cleaner as described in Step 4 (page 24) when cleaning the firepot of ashes.

Inspect and clean the heat baffle for any grease or debris.

NOTE: Traeger’s drip tray liners can help keep your grill clean and can help reduce the risk of flare-ups.

2. CREOSOTE REMOVAL:

When wood pellets are burned slowly, they produce tar and other organic vapors that combine with expelled moisture to form creosote. The creosote vapors condense in the relatively cool exhaust vent of a slow-burning fire. As a result, creosote accumulates on the exhaust vent lining. When ignited, creosote makes an extremely hot fire. Airborne grease particles will travel through the cooking chamber, and some of this airborne grease will accumulate on the exhaust vent lining, similar to creosote. This could contribute to a fire.

Periodically scrape the creosote and grease accumulation from the inside of the vertical and horizontal sections of the flue pipe or interior lining using a stiff, nonmetallic tool. A wooden paint stir stick, for example, would work for this task. Once the creosote and grease residue has been loosened from the interior lining and ventilation gaps in this downdraft system, much of it can be removed with paper towels or disposable rags. Do not spray water or other liquid cleaners onto the inside of your grill to remove creosote.

When creosote or grease has accumulated, it should be removed to reduce the risk of a fire.

3. OUTSIDE STORAGE:

▲ CAUTION If the grill is stored outside, care should be taken to ensure that water does not get into the pellet hopper. Wood pellets expand greatly when wet and will jam your auger. Always cover your grill when not in use with a Traeger® Grill Cover. This custom-fit cover can be purchased at traeger.com.

MAINTAINING YOUR GRILL (CONTINUED)

4. CLEANING THE ASH FROM INSIDE AND AROUND THE FIREPOT (EVERY 20 HOURS OF USE):

⚠ WARNING Make sure that the grill is COLD and ashes are extinguished and COLD before cleaning the ash.

⚠ WARNING Disposal of ashes should be done only according to the following instructions.

Excess ash in the firepot will hamper ignition and may cause your fire to go out. The firepot should be inspected occasionally and cleaned to remove the ash buildup. Again, cleaning the ash from in and around the firepot should be done only when the grill and ash are COLD.

Remove the grill grates, grease drip tray, and heat baffle to provide access to the firepot and the interior of the grill. Much of the ash outside of the firepot can be removed from the grill with a small metal fireplace shovel or other similar tool.

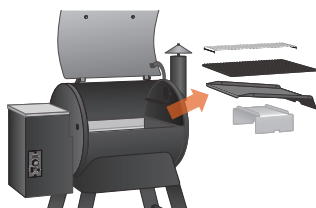

⚠ WARNING A dedicated vacuum cleaner is the best way to remove ashes from the firepot, but this must be done with extreme care to avoid the risk of fire. Again, cleaning the ash from in and around the firepot should be done only when the ash is extinguished and the grill and ash are COLD.

A utility-type vacuum cleaner having a metal collection canister without a bag would be best for this task. However, almost any vacuum cleaner will work safely if this procedure is properly followed.

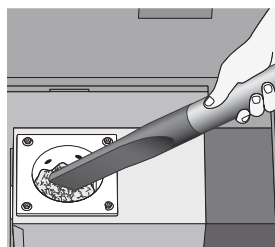

After ensuring that the ash in the firepot is COLD, vacuum the ash from the inside of the firepot.

- If your vacuum cleaner is a bagless model, empty any previously accumulated debris from the collection chamber. Then vacuum the ash from the inside of the firepot. Once the firepot is clean, empty the collection chamber into the metal container handled in the manner described below under Disposal of Ashes without delay. Make sure that there is no remaining ash residue left in the collection chamber.
- If your vacuum cleaner is a model that uses a disposable bag, install an unused bag in the machine. Then vacuum the ash from the inside

of the firepot. Once the firepot is clean, remove the bag from the vacuum cleaner and place it in a metal container handled in the manner described under Disposal of Ashes below.

5. DISPOSAL OF ASHES:

⚠ WARNING Ashes should always be completely cooled before handling. Ashes should be placed in a metal container with a tight-fitting lid. The closed container of ashes should be placed on a noncombustible floor or on the ground, well away from all combustible materials, pending final disposal. Ashes should be retained in the closed container until they are disposed.

6. CLEANING THE GRILL GRATES:

⚠ DANGER Cleaning the grill grates works best while they are still warm. **Be careful not to burn yourself. Heat-protective gloves are recommended.** We recommend keeping a long-handled cleaning brush near the grill. After removing your food, give the grill grate a quick brushing. It takes only a minute and it will be ready the next time you want to use the grill.

7. CLEANING OUTSIDE SURFACES:

⚠ WARNING Turn the main power switch OFF (O) and disconnect the power cord before initiating cleaning.

Use a disposable rag or cloth dampened with Traeger® All Natural Cleaner or warm, soapy water to wipe the grease from the outside of the grill. **DO NOT** use oven cleaner, abrasive cleansers, or abrasive cleaning pads on the outside grill surfaces.

8. CLEANING HOPPER:

Regularly change out your pellets and vacuum out the sawdust from the hopper and auger.

9. TESTING THE GRILL AFTER CLEANING:

Before replacing the heat baffle, grease drip tray, and the grill grates, plug the power cord into an appropriate grounded/earthed electrical outlet and turn the main power switch ON (I). After you set the temperature, pellets should fall into the firepot and the hot rod should begin to heat (it will start to turn red).

⚠ CAUTION Do not touch the hot rod.

When flames start to come out of the firepot, run the shut-down cycle. Let the grill cool down. Now you're ready to place the heat baffle, grease drip tray, grill grates, and food back onto the grill.

- If the power supply cord is damaged, it must be replaced by a special cord assembly available from Traeger.

FREQUENTLY ASKED QUESTIONS

Following are frequently asked questions along with their answers:

QUESTION	ANSWER
<p>Why won't my grill power on?</p>	<p>Verify power at the electrical outlet. If the power cord is connected to a GFCI (ground fault circuit interrupter), check and reset if necessary. (Note that a GFCI outlet may be located in a nearby outlet on the same electrical branch circuit.) Initiate start-up. If no ignition, see next answer.</p> <p>Check power supply cord.</p> <p>Check your extension cord.</p>
<p>Why won't my grill ignite?</p>	<p>Verify that you have properly maintained your grill as described in "Maintaining Your Grill" on pages 23-24 and there is not excessive ash in your firepot.</p> <p>Verify that there are pellets in the pellet hopper and that the auger has been primed (see page 13). Verify that pellets are reaching the firepot. If this is the initial firing or the grill has run out of pellets, allow enough time for the pellets to travel from the pellet hopper to the firepot (can take up to 7 minutes).</p> <p>If there are no pellets in your firepot, initiate start-up. See "Using Your Grill" on page 15. If there are still no pellets in the firepot, proceed to next answer.</p> <p>Check the draft inducer fan and the auger drive motor for operation. If both are operating, then the hot rod needs to be replaced. If one or both are not operating, contact Traeger's customer service (see page 29) for additional troubleshooting help or to place an order.</p>
<p>Why are no pellets being delivered into the firepot?</p>	<p>Confirm there are pellets in the pellet hopper.</p> <p>If you have pellets and they aren't being delivered, contact customer service (see page 29).</p> <p>If the auger drive motor is operating (check the small fan blade on the back of the motor), the problem is in the digital controller. Contact your Traeger dealer or Traeger's customer service (see page 29).</p> <p>If the auger drive motor is not operating but the draft inducer fan is operating, then the problem is in the auger system, which will need to be checked. With the main power switch OFF (O), locate the small fan blade on the back of the auger drive motor. CAUTION! While watching the fan blade, turn the main power switch ON (I). If the fan blade does not turn, turn the main power switch OFF (O). This indicates a defective auger drive motor, and it will need to be replaced. Contact your Traeger dealer or Traeger's customer service (see page 29) to place an order. If the fan blade turns a bit and then stops, continue watching and turn the main power switch OFF (O). If the fan blade unwinds slightly, this indicates a jam in the auger system, which will need to be cleared.</p> <p>DANGER! Turn the main power switch OFF (O) and disconnect the power cord. Remove the pellets from the pellet hopper. Check for foreign objects and wet or decomposed pellets, both of which can cause a jam in the auger system. The auger will need to be removed to clear a jam in the auger system. See "How do I remove the auger if it jams?"</p>
<p>Why is the temperature of my grill fluctuating?</p>	<p>Temperature fluctuations are normal for Traeger® Grills. Any significant fluctuation could be the result of wind, air temperature, improper start-up procedure, improper use, or lack of grill maintenance. Traeger recommends using a Traeger® Grill Insulation Blanket designed for your grill to operate in below-freezing winter conditions.</p>

FREQUENTLY ASKED QUESTIONS (CONTINUED)

QUESTION	ANSWER										
<p>How do I remove the auger if it jams?</p>	<p>First, let the grill cool completely to prevent a fire. Remove any covers necessary to access the auger drive motor. Remove the pin connecting the auger drive motor shaft to the auger shaft and the screw retaining the auger bushing into the auger tube. With a small pipe wrench or locking pliers on the auger shaft, turn the auger counterclockwise. It will turn hard until it breaks free; then the auger will turn freely. Remove the auger and clean all pellets, ash, or foreign objects from the auger, auger tube, and firepot. (See instructions for proper handling and disposal of ash on page 24.) Sand the outside surfaces of the auger with medium grit sandpaper. Check the inside of the auger tube and sand it if needed. Vacuum the sanding grit out of the auger tube and firepot when finished. Check that the auger rotates freely. Reattach the auger shaft to the auger drive motor shaft.</p>										
<p>Why does my grill fire go out on SMOKE setting?</p>	<p>Pellets are old or damp, or there may be excess ash in the firepot which needs to be cleaned.</p> <table border="1" data-bbox="332 646 1524 1318"> <tr> <td data-bbox="332 646 568 1318"> <p>WARNING! If the fire in the firepot goes out while smoking and there are sufficient pellets in the pellet hopper, it is important to follow these steps. Failure to do so may cause a hazardous “overfiring” of your grill due to an excess of unburned pellets in the firepot.</p> </td> <td data-bbox="568 646 1524 762"> <p>DANGER! Turn the main power switch OFF (O) and disconnect the power cord. Allow the grill to cool thoroughly. Open the door and remove all food, the porcelain-coated grill grates, the grease drip tray, and the heat baffle.</p> </td> </tr> <tr> <td data-bbox="332 762 568 846"></td> <td data-bbox="568 762 1524 846"> <p>WARNING! Remove all unburned pellets and ash from inside and around the firepot. (See instructions for proper handling and disposal of ash in on page 24.)</p> </td> </tr> <tr> <td data-bbox="332 846 568 1035"></td> <td data-bbox="568 846 1524 1035"> <p>Before replacing the heat baffle, grease drip tray, and porcelain-coated grill grates, plug the power cord into the appropriate grounded electrical outlet, turn the main power switch ON (I), and turn the temperature dial to SMOKE. Pellets should fall into the firepot and the hot rod should begin to heat (it will start to turn red). CAUTION! Do not touch the hot rod.</p> </td> </tr> <tr> <td data-bbox="332 1035 568 1245"></td> <td data-bbox="568 1035 1524 1245"> <p>When flames start to come out of the firepot, turn the main power switch OFF (O). Let the grill cool down. Now you’re ready to place the heat baffle, grease drip tray, and grill grates back into the grill. With the door open, turn the main power switch ON (I) and turn the temperature dial to your desired temperature. In about two minutes, the pellets will ignite and whitish-gray smoke will come out of the grill. Allow the grill to preheat for 10 minutes before placing food on the grill.</p> </td> </tr> <tr> <td data-bbox="332 1245 568 1318"></td> <td data-bbox="568 1245 1524 1318"> <p>If this does not fix the problem, contact Traeger’s customer service (see page 29) for assistance.</p> </td> </tr> </table>	<p>WARNING! If the fire in the firepot goes out while smoking and there are sufficient pellets in the pellet hopper, it is important to follow these steps. Failure to do so may cause a hazardous “overfiring” of your grill due to an excess of unburned pellets in the firepot.</p>	<p>DANGER! Turn the main power switch OFF (O) and disconnect the power cord. Allow the grill to cool thoroughly. Open the door and remove all food, the porcelain-coated grill grates, the grease drip tray, and the heat baffle.</p>		<p>WARNING! Remove all unburned pellets and ash from inside and around the firepot. (See instructions for proper handling and disposal of ash in on page 24.)</p>		<p>Before replacing the heat baffle, grease drip tray, and porcelain-coated grill grates, plug the power cord into the appropriate grounded electrical outlet, turn the main power switch ON (I), and turn the temperature dial to SMOKE. Pellets should fall into the firepot and the hot rod should begin to heat (it will start to turn red). CAUTION! Do not touch the hot rod.</p>		<p>When flames start to come out of the firepot, turn the main power switch OFF (O). Let the grill cool down. Now you’re ready to place the heat baffle, grease drip tray, and grill grates back into the grill. With the door open, turn the main power switch ON (I) and turn the temperature dial to your desired temperature. In about two minutes, the pellets will ignite and whitish-gray smoke will come out of the grill. Allow the grill to preheat for 10 minutes before placing food on the grill.</p>		<p>If this does not fix the problem, contact Traeger’s customer service (see page 29) for assistance.</p>
<p>WARNING! If the fire in the firepot goes out while smoking and there are sufficient pellets in the pellet hopper, it is important to follow these steps. Failure to do so may cause a hazardous “overfiring” of your grill due to an excess of unburned pellets in the firepot.</p>	<p>DANGER! Turn the main power switch OFF (O) and disconnect the power cord. Allow the grill to cool thoroughly. Open the door and remove all food, the porcelain-coated grill grates, the grease drip tray, and the heat baffle.</p>										
	<p>WARNING! Remove all unburned pellets and ash from inside and around the firepot. (See instructions for proper handling and disposal of ash in on page 24.)</p>										
	<p>Before replacing the heat baffle, grease drip tray, and porcelain-coated grill grates, plug the power cord into the appropriate grounded electrical outlet, turn the main power switch ON (I), and turn the temperature dial to SMOKE. Pellets should fall into the firepot and the hot rod should begin to heat (it will start to turn red). CAUTION! Do not touch the hot rod.</p>										
	<p>When flames start to come out of the firepot, turn the main power switch OFF (O). Let the grill cool down. Now you’re ready to place the heat baffle, grease drip tray, and grill grates back into the grill. With the door open, turn the main power switch ON (I) and turn the temperature dial to your desired temperature. In about two minutes, the pellets will ignite and whitish-gray smoke will come out of the grill. Allow the grill to preheat for 10 minutes before placing food on the grill.</p>										
	<p>If this does not fix the problem, contact Traeger’s customer service (see page 29) for assistance.</p>										
<p>With the Traeger Digital Pro Controller, what dial setting is recommended for starting the grill?</p>	<p>The auto-start procedure is the same for all grill controls. With the door closed, turn the main power switch ON (I) and turn the temperature dial directly to desired temperature. In about two minutes, the pellets will ignite and whitish-gray smoke will come out of the grill. After the pellets have ignited, allow the grill to preheat for 10 minutes with the door closed before placing food in the grill.</p>										
<p>How do I protect my paint finish?</p>	<p>Use a protective cover on the grill to protect your paint finish and power cord. A Traeger® Grill Cover is highly recommended. Covers are available from your Traeger dealer, or log onto our website, traeger.com.</p> <p>Every 90 days, thoroughly clean the outside of your grill with Traeger® All Natural Cleaner.</p>										
<p>Is it ok to use my grill in the rain (and snow)?</p>	<p>Your grill can be used in a light rain or light snow; but it is an electrical appliance, so take extra precautions to be sure that the power cord and any extension cord are properly joined and the junction of the power cord and the extension cord is positioned so that it is clear of any standing water and snow.</p>										
<p>Where can I get a new part for my grill?</p>	<p>Contact Traeger’s customer service (see page 29) to place an order. Many parts are available on our website at traeger.com.</p> <p>Be prepared with your grill’s model and serial number (located on the label inside the hopper lid) to accurately identify the necessary part for your specific model.</p>										

OPERATING TIPS

1. You can change the temperature at any time during grilling to increase or decrease cooking temperature. It is best practice to give the grill some time to reach the desired temperature before making additional temperature changes.
2. Your Traeger® Grill is designed to operate with the door closed. Opening the grill door greatly lengthens your cooking time.
 - When putting frozen, raw, cold, or otherwise uncooked food on the grill, this may result in a temporary temperature drop of your grill's internal temperature.
3. Do not overload cooking surface with excessive amounts of food that reach beyond the edges of the footprint of the drip tray. This can lead to interference with proper cooking airflow.
4. Always take into account the type of food you are cooking:
 - Thin foods need high heat and shorter cook times, while thicker foods need low heat and longer cook times.
 - Vegetables take longer to cook than meats at the same cooking temperatures.
 - Always check that the internal temperature of the meat that you are cooking reaches a safe temperature for eating.
5. Keep the grill clean. Vacuum out the sawdust from the hopper and auger. Regularly inspect your grill for accumulated grease. Most grease fires are caused by not properly maintaining the grill and failing to clean the Traeger® Grease Management System (TGMS) on a consistent basis (see "Maintaining Your Grill" on pages 23-24). Even if there is ample room in the grill, be cautious of loading excessive amounts of food that can release large quantities of flammable grease (for example, more than a pound of bacon). If the grill has not been well-maintained or if your previous cooks have produced large quantities of flammable grease, it is highly recommended that the grease be cleaned from the grill before using it again.
NOTE: If changed frequently, Traeger's drip tray liners can help keep your grill clean and thereby can help reduce the risk of a grease fire.

ACCESSORIES

INSULATION BLANKET

Protect your Traeger® Pro Series Grill with a premium Insulation Blanket, designed to maintain the set temperature in below-freezing conditions. The Insulation Blanket is available for purchase at traeger.com.



WARNING! Do not install your Insulation Blanket until the grill has completely cooled.

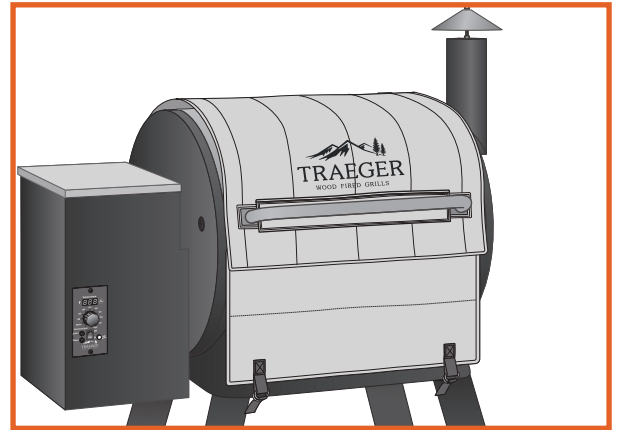

SERVICE



TRAERGER'S LEGENDARY CUSTOMER SERVICE is the best out there. If you have any questions about your Traeger® Grill or need tips on cooking your first holiday turkey, our seasoned experts have your back. We're here for you 365 days a year, including holidays. For assistance with assembly, installation, safe operation, parts, or general customer service, you can visit our website or write us at:

TRAERGER'S CUSTOMER SERVICE

For support please visit:

<https://www.traeger.com/support>

TRAERGER PELLET GRILLS LLC

1215 E. Wilmington Ave., Suite 200
Salt Lake City, UT 84106

TRAEGER® GRILL LIMITED WARRANTY



7-YEAR LIMITED WARRANTY

Traeger Pellet Grills LLC warrants this Traeger® Grill for the components, coverage, and warranty period listed in the table below under normal use and proper maintenance. This warranty gives you specific legal rights, and you may also have other rights which may vary among different states and provinces. The warranty period starts from the date of original purchase from [traeger.com](https://www.traeger.com) or a Traeger authorized dealer. A list of Traeger authorized dealers is available at <https://www.traeger.com/dealers> (together each an “Authorized Seller”). The warranty period and coverage for the replacement parts shall be as follows:

Warranty Periods and Coverage		
Components	Warranty Period	Coverage
Body, Legs, Hopper Cover	7 Years	Will not rust through
Grates	3 Years	Will not rust through
Fan, Auger Motor, Controller	3 Years	Material and Manufacturing Defects
All Terrain Wheels	3 Years	Material and Manufacturing Defects
Hot Rod, Cord, RTD, Thermocouple	1 Year	Material and Manufacturing Defects
Heat Baffle, Drip Tray	1 Year	Will not rust through
Door Gasket	1 Year	Will not tear or fray
Meat Probe	1 Year	Material and Manufacturing Defects

Traeger’s entire liability and your exclusive remedy shall be replacement of the defective parts of your Traeger® Grill, if any. Original part(s) approved for return by Traeger’s Customer Service must be returned prepaid. Traeger may replace defective parts with new or refurbished parts, at Traeger’s sole discretion on an as available basis within ninety days. Without limiting the exclusions stated above, there is not warranty coverage for: (i) paint damage caused by grease fires; (ii) UV exposure; (iii) normal wear and tear; and (iv) warping of the drip tray or heat baffle.

Traeger® Grills are designed to be modular for simple repair by regular users. Traeger’s entire obligation under this warranty shall be to provide you with replacement of any defective parts and to provide you with instructions on how to make the replacement yourself. Traeger may replace defective parts with new or refurbished parts. Traeger reserves the right to inspect any grill (shipping paid by Traeger) and to analyze any usage information including, without limitation, any digital connected grill data (to the extent covered by our data protection policy). To validate and process a warranty claim Traeger may require that you provide reasonable evidence of your issue, including participating in video chats, phone conversations, providing photos, and providing other relevant information. Labor charges connected with the replacement of defective parts and freight charges to ship parts shall be paid at your expense.

The limitations in the following paragraph do not apply to residents of Quebec to whom the Quebec Consumer Protection Act applies.

FOR GREATER CERTAINTY AND TO FULLEST EXTENT PERMITTED BY LAW, TRAEGER PELLETT GRILLS LLC SHALL NOT BE LIABLE UNDER THIS OR ANY IMPLIED WARRANTY FOR INCIDENTAL, CONSEQUENTIAL DAMAGES, INDIRECT OR SPECIAL LOSS OF DATA, EXEMPLARY, PUNITIVE, OR ENHANCED DAMAGES, LOST PROFITS OR REVENUES, OR DIMINUTION IN VALUE ARISING OUT OF OR RELATING TO YOUR USE OF YOUR GRILL, REGARDLESS OF (A) WHETHER SUCH DAMAGES WERE FORESEEABLE, (B) WHETHER OR NOT TRAEGER WAS ADVISED OF THE POSSIBILITY OF SUCH DAMAGES, AND (C) THE LEGAL OR EQUITABLE THEORY (CONTRACT, TORT, OR OTHERWISE) UPON WHICH THE CLAIM IS BASED, AND NOTWITHSTANDING THE FAILURE OF ANY AGREED OR OTHER REMEDY OF ITS ESSENTIAL PURPOSE. THIS WARRANTY GIVES THE RETAIL CUSTOMER SPECIFIC LEGAL RIGHTS AND THE CUSTOMER MAY HAVE OTHER RIGHTS WHICH VARY FROM STATE/PROVINCE TO STATE/PROVINCE. BOTH YOU AND TRAEGER INTEND FOR THIS WARRANTY TO BE THE YOUR EXCLUSIVE REMEDY FOR A DEFECTIVE GRILL.

This warranty shall be void if: (i) the grill is not assembled or operated in accordance with Traeger's operating instructions provided with this grill; (ii) the grill is not purchased from an Authorized Seller; (iii) the grill is resold or traded to another owner; (iv) there has been use of any third party components, parts, or accessories; (v) fuels other than wood pellets designed for wood pellet grills and barbecues have been used with the grill; (vi) wood stove heating pellets are used in the grill; (vii) the grill has been used in a commercial or food service application; (viii) the user has allowed the grill to become damaged, abused, or otherwise failed to maintain the grill in accordance with Traeger's operating instructions; or (ix) there has been any unapproved modification of this grill.

Please note that because Traeger is unable to oversee or control the quality of its products sold by unauthorized sellers, Traeger's warranty is only available if you purchased your grill from an Authorized Seller. Traeger's warranty extends only to products purchased from an Authorized Seller.

To process a warranty claim, contact Traeger's customer service at the phone number or address listed above. Traeger requires proof of your date of purchase from an Authorized Seller. You should retain your sales slip or invoice along with this manual with your valuable documents.

Customers outside of the United States and Canada should note that NOT all warranty policies stated herein are consistent globally. Customers should contact the local distributor in their current country from the list at International Support for instructions regarding warranty claims specific to that country. The process described herein will not work for international warranty requests.

ADDITIONAL IMPORTANT WARRANTY INFORMATION

- We are not responsible for items lost in transit. For this reason, we highly recommend getting a tracking number or delivery confirmation when shipping your package.
- The product you send to us becomes the possession of Traeger and will not be returned to you.

Traeger will determine if your warranty claim is covered under this warranty policy at Traeger's sole and complete discretion, and failure to follow the required procedures may void your warranty claim. This warranty gives you specific legal rights, and you may also have other rights which vary from State/Province to State/Province or Country to Country.





LIVE FLAVOR FULL

**UNLOCK THE FULL POWER OF YOUR GRILL
WITH THE TRAERGER APP**

FOLLOW US @TRAERGERGRILLS



Distributed by:
Costco Wholesale Corporation
P.O. Box 34535
Seattle, WA 98124-1535
USA
1-800-774-2678
www.costco.com



Costco Wholesale Canada Ltd.
415 W. Hunt Club Road
Ottawa, Ontario
K2E 1C5, Canada
1-800-463-3783
www.costco.ca



Costco Wholesale UK Ltd /
Costco Online UK Ltd
Hartspring Lane
Watford, Herts
WD25 8JS
United Kingdom
01923 213113
www.costco.co.uk



Costco Wholesale Australia
Pty Ltd
17-21 Parramatta Road
Lidcombe NSW 2141
Australia
www.costco.com.au

Traeger Pellet Grills LLC
1215 E. Wilmington Ave, Suite 200
Salt Lake City, UT 84106

traeger.com

Made in China
Fabriqué en Chine
Hecho en China