

# AURA™ INTERIOR

## 6PC INSTALLATION GUIDE

### MAIN COMPONENTS



LIGHT STRIPS



AURA CONTROL BOX

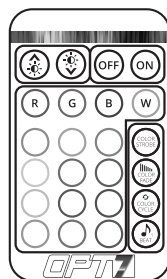

HAND HELD REMOTE

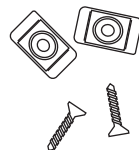

MOUNTING KIT

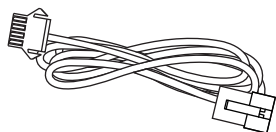

EXTENSION WIRES

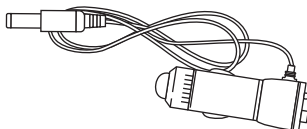

CIGARETTE LIGHTER POWER ADAPTER

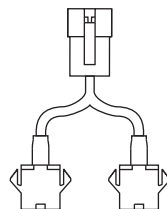

Y-SPLITTERS

# INSTALLATION

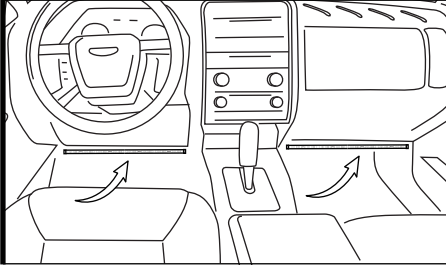

As shown below, connect all light strips to the control box with the included extension cables.

## STEP 1

Decide where to locate the light strips and ensure wiring has enough length for control box to be installed in desired location.

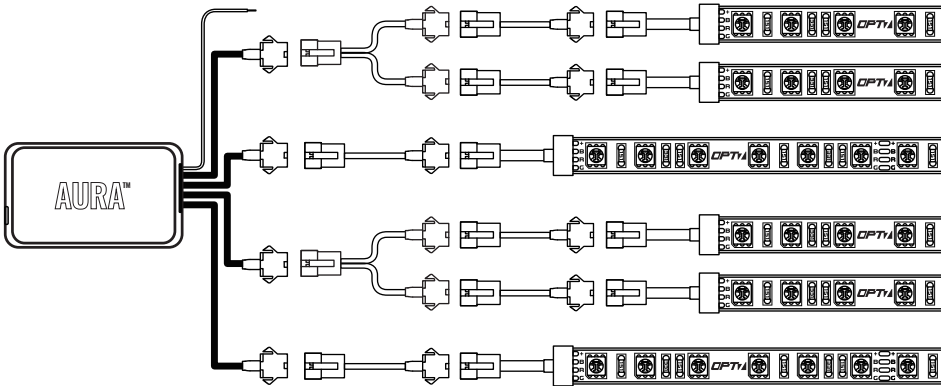
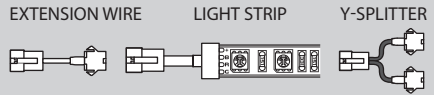

### WARNING

1. Connecting to more than 10 AMP will override the kit and cause early failure, ensure it is 10AMPS or less!!
2. Please ensure that the LED bars or strips/control box/wiring all are mounted in areas where will not exceed 85°C or 185°F.

Once connected, plug the control box Cigarette Power Adapter into an available 12 volt charging port.

12 VOLT CHARGING PORT



CIGARETTE POWER ADAPTER

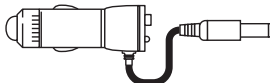

# INSTALLATION

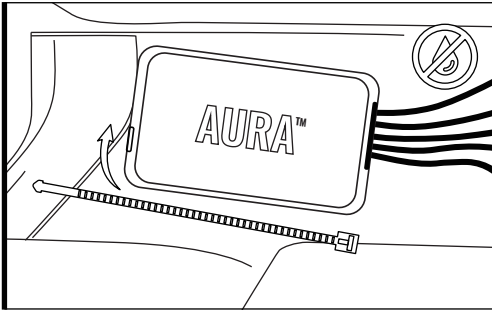

## STEP 2

Secure Control box in desired location with Velcro or zip ties.

**\* CONTROL BOX NOT WATERPROOF**  
Ensure the control box is safely and securely hidden from exposing elements of moisture.

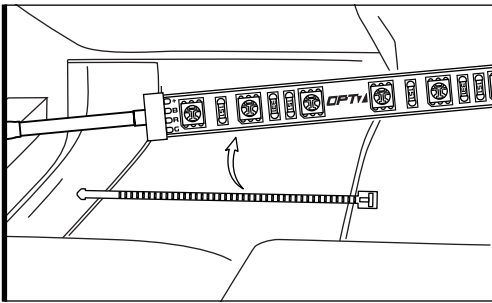

## STEP 3

Use the zip ties to tie all wiring away from all moving components.

## STEP 4

Using the included E-Z Remote, select your desired color or pattern.

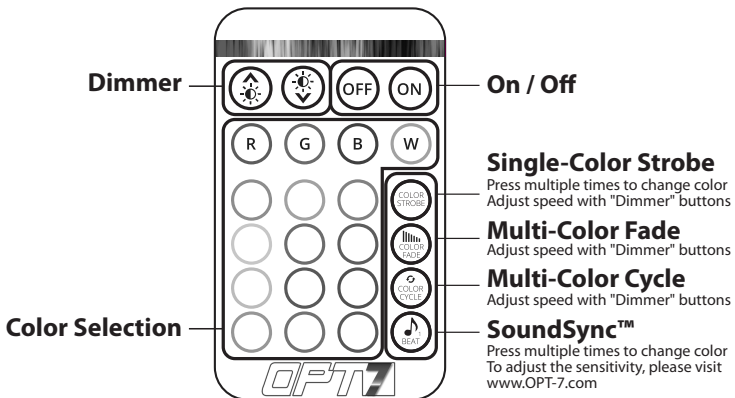

## | AUX WIRING FOR A DOOR/DOME LIGHT



Please scan to see a detail instruction on Door Assist Sync or go to <https://wintis.ladesk.com/549690-AURA-Door-AssistAUX-Installation-Guide>

## | OPTIONAL UPGRADE

Upgrade your Aura Original Control Box to the Aura Pro Bluetooth Control Box. All new AURA Pro Bluetooth is App enabled by a smartphone controller (iOS & Android Compatible).

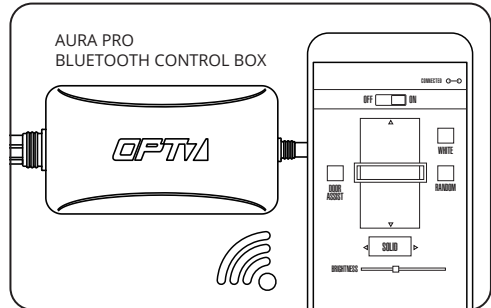

## | DISCLAIMER

OPT7 Lighting is not liable for damages or personal injuries while installing this product. The Installation Guide is intended as assistance to reduce setup time. OPT7 Lighting assumes no responsibility for improper installation. If you are unfamiliar with your vehicle or inexperienced with aftermarket upgrades, please seek professional assistance.

OPT7 recommends installation for safety and guidance.

Modified installations or installation recommendations not specified by OPT7 Lighting will void product warranty.