

Turonic PH950

Air Purifier + Humidifier



USER'S GUIDE

Please read this manual before using the product

PACKAGE CONTENT



1. Air purifier
2. Mesh pre-filter #1
3. Combination filter #2
(cold catalyst + activated carbon filter)
4. Combination filter #3
(antibacterial cotton + HEPA filter)
5. Water tank with humidification filter
6. Remote control
7. User's guide

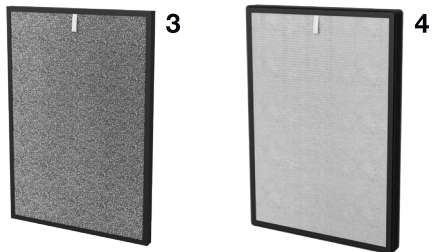

PRODUCT STRUCTURE



Pre-filter #1



Combination filter #2

Cold catalyst + Activated carbon

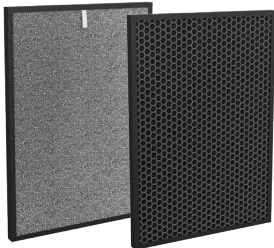

Combination filter #3

Antibacterial cotton + HEPA 13

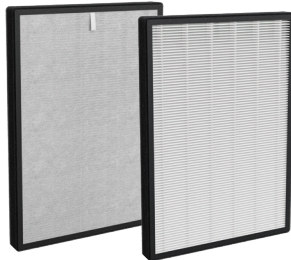

Negative Air Ionizer

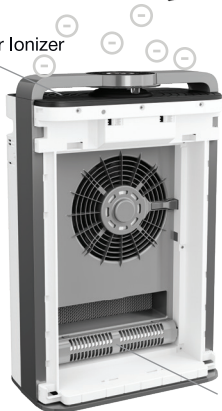

Water tank

Humidification filter

Anti-bacterial balls

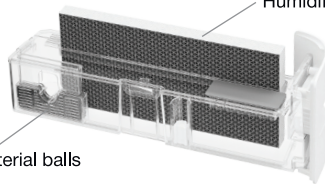

DISPLAY AND TOUCH CONTROL PANEL



ON/OFF - turns on/off the purifier

AUTO - turns on the Auto mode

TIMER - sets 1-12 hours to turn off the machine

IONIZER - turns on/off the ionization

STERILIZE - turns on/off the UV

RESET - shows purifier runtime/resets the filter life management function

SLEEP - turns on/off the Sleep mode (machine runs at low speed - low noise)

CHILD LOCK - turns on/off the Child Lock mode

SPEED +/- - changes the fan speed

CHANGE FILTER - filter cleaning/replacement reminder indicator

WATER TANK - low water level indicator

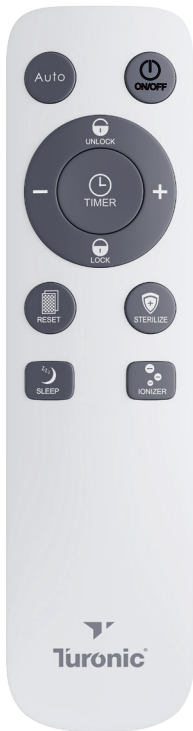

REMOTE BUTTONS

ON/OFF - turns the unit on/off

AUTO - turns on the Auto mode

SPEED +/- - changes the fan speed

TIMER - sets 1-12 hours to turn off the machine

UNLOCK - disables the Child Lock mode

LOCK - enables the Child Lock mode

IONIZER - turns on/off the ionization

STERILIZE - turns on/off the UV

RESET - shows purifier runtime/resets the filter
life management function

SLEEP - turns on/off the Sleep mode (machine
runs at low speed - low noise)

PM2.5 DIGITAL DISPLAY

The **TURONIC PH950** is equipped with the highly precise PM2.5 laser sensor to inform a user about the concentration of PM in the air. The PM concentration is shown with digits and also divided by 4-color light indications:

1. Excellent Air Quality - Green light indication.



3. Medium Air Quality - Yellow light indication.



2. Good Air Quality - Blue light indication.



4. Poor Air Quality - Red light indication.



NOISE LEVEL

The noise level of the PH950 purifier depends on the speed the machine is currently running on. The purifier noise level ranges from 36 dB on the minimum speed to 61 dB on the maximum one.

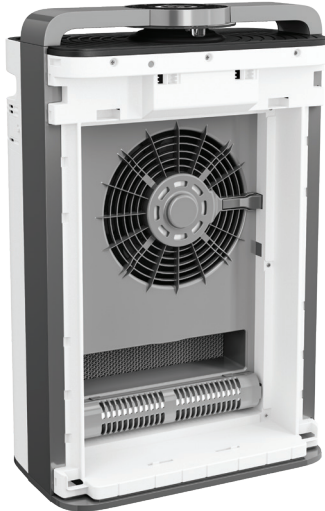

HOW TO START

The new **TURONIC PH950** already comes with two combination filters inside it.

To start using it:

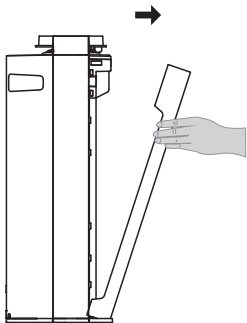

1. Open the filter cover.

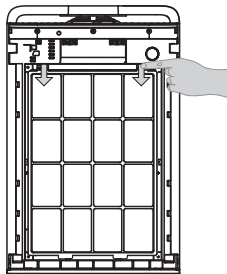

2. Remove the pre-filter.

3. Take off two polybags containing the combination filters

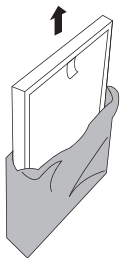

4. Remove the combination filters from the polybags.

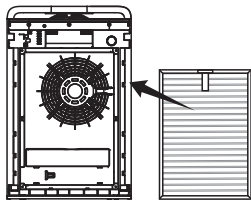

5. Install the first combination filter marked with digit 3 (antibacterial cotton + HEPA) into the purifier. Please note that the side with the pull tab should be directed outwards.

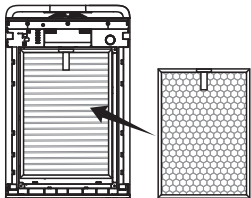

6. Install the second combination filter marked with digit 2 (cold catalyst + activated carbon) into the purifier. Please note that the side with the pull tab should be directed outwards.

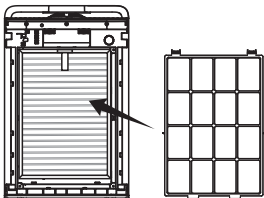

7. Install the pre-filter back on its place.

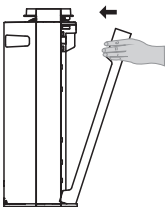

8. Close firmly the filter cover.

9. Connect the power plug to a power source.

10. Press the **ON/OFF** button on the purifier's control panel or on the remote control.

The purifier will start working. You will see the LED light indication (green, blue, yellow or red depending on the air quality) and altering digits standing for the air pollution index.

Note:

When placing the unit, make sure to allow at least 11.8 inch (30 cm) clearance between the air inlets/outlet and any obstacle.

HUMIDIFICATION

The **PH950** purifier has the humidification feature to maintain the humidity of ambient air at the required and comfortable level. When water is added into the water tank, the purifier starts to generate steam automatically. The humidification effect depends on the fan speed, the higher the speed is, the more steam is generated and dispensed in the air.

To start using this feature:

1. Take out the water tank on the side of the purifier.
2. Remove the polybag containing the humidification filter.
3. Remove the humidification filter from the polybag.

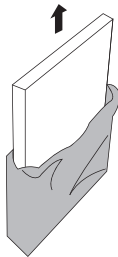
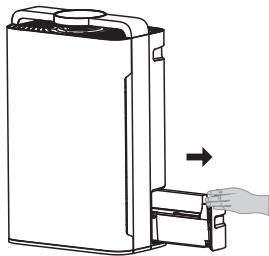

- Put the humidification filter back into the water tank.
- Open the rubber lid on the water tank and add about 1,4-1.5L of water (85-90% of the tank). You can use tap water for this purpose, but discilated water is better.
- Close the rubber lid.
- Install the water tank back on its place.

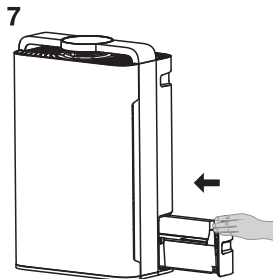
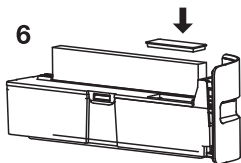
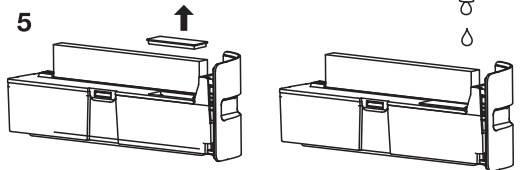
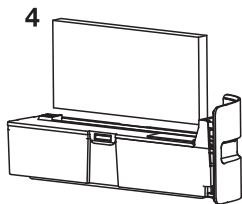

After the tank with water is installed into the purifier, you will see the **HUMIDIFY** indicator light on the control panel.

When the water level becomes low, the **WATER TANK** indicator light will start flashing and the **HUMIDIFY** indicator light will go off on the control panel. The purifier will continue working normally.



REMOTE CONTROL

The supplied remote control comes with the lithium CR2032 battery pre-installed. To activate the remote control:

1. Remove the battery cover by twisting it counterclockwise.
2. Remove the protective matte plastic film between the battery and the spring.

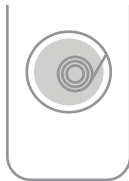
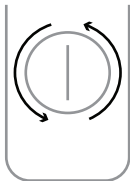

3. Close the battery cover by twisting clockwise.



To change the battery:

1. Remove the battery cover by twisting it counterclockwise.
2. Using some prime tool or a flat screwdriver carefully eject the old battery.
3. Install new CR2032 battery.
4. Close the battery cover.

FAN SPEEDS

The **PH950's** inbuilt fan can operate on 8 speeds and in the Auto Mode. To change the fan speed, use the **SPEED +/-** buttons on the purifier's control panel or on the remote control.

1 speed - 400 r/min

2 speed - 460 r/min

3 speed - 570 r/min

4 speed - 660 r/min

5 speed - 770 r/min

6 speed - 860 r/min

7 speed - 1050 r/min

8 speed - 1150 r/min

When turned on, the **PH950** purifier starts working in the Auto mode (the **AUTO** button is lit up on the control panel).

In the Auto Mode, the fan speed is set automatically, according to the air quality readings obtained from the PM2.5 sensor. Please see the table below for more information:

Relation between speed and PM2.5 data

| Speed | PM2.5 data | Light color | Speed | PM2.5 data | Light color |
|-------|------------|-------------|-------|------------|-------------|
| 1 | 0-50 | Green | 5 | 121-140 | Yellow |
| 2 | 51-80 | | 6 | 141-160 | |
| 3 | 81-100 | Blue | 7 | 161-300 | Red |
| 4 | 101-120 | | 8 | 301-500 | |

To exit the Auto mode, change the speed using the **SPEED +/-** buttons on the control panel or on the remote control.

When the Auto mode is disabled, the **AUTO** button light will go off.

UV/IONIZATION

The **TURONIC PH950** uses ultraviolet and ionization technologies to clean the air. Once you turn on the unit, UV/Ionisation are enabled (**STERILIZE** and **IONIZER** buttons are lit up on the control panel). To disable the ionization, press the **IONIZER** button on the control panel or on the remote control. To disable the UV, press the **STERILIZE** button on the control panel or on the remote control. Once disabled the **STERILIZE** and **IONIZER** buttons will go off.

SLEEP MODE

The **TURONIC PH950** has the Sleep mode which allows the purifier to operate at the lowest fan speed with the lowest noise emission ($\leq 36\text{dB}$) and no LED indication.

To enable/disable it, press the **SLEEP** button on the purifier's control panel or on the remote control. Once enabled, the **SLEEP** button will light up on the control panel and once disabled - will go off.

Also, the **PH950** model is equipped with the Light Sensor. This allows the machine to go to the Sleep mode automatically 2 minutes after the surrounding light is lower than 5 lux. The unit quits the Sleep mode 3 minutes after the surrounding light is more than 5 lux.

Note:

The **Light Sensor** works in the Auto mode only.

TIMER

The **TURONIC PH950** can turn off automatically in a particular period of time (1-12 hours). To enable the timer, press the **TIMER** button on the purifier's control panel or on the remote control. Each button press adds one hour. Once the timer is enabled, the **TIMER** button will light up on the control panel.

To disable the timer, press the **TIMER** button on the purifier's control panel or on the remote control several times until the **TIMER** button light goes off on the control panel.

CHILD LOCK

You can disable the buttons on the purifier's control panel by using the Child Lock. To enable it, press the **CHILD LOCK** button on the purifier's control panel or the **LOCK** button on the remote control. Once enabled, the **CHILD LOCK** button will light up on the control panel.

To disable it, press and hold the **CHILD LOCK** button on the control panel for 5 seconds or press the **UNLOCK** button on the remote control. Once disabled, the **CHILD LOCK** button light will go off.

Note:

1. When the Child Lock is enabled, all the buttons (except for the **UNLOCK** one) on the remote control remain inactive until the Child Lock is disabled.

WI-FI CONTROL

The **PH950** purifier is equipped with the Wi-Fi feature compatible with almost all popular Smart Home Kits (Alexa, Google, etc.).

To start using it:

1. Download the Smart Life app using the following QR code (available for Android and iOS) and open it:



2

2. Log in or Sing up to use all the features of this app.

3. On the Home tab, tap on Add Device.



3

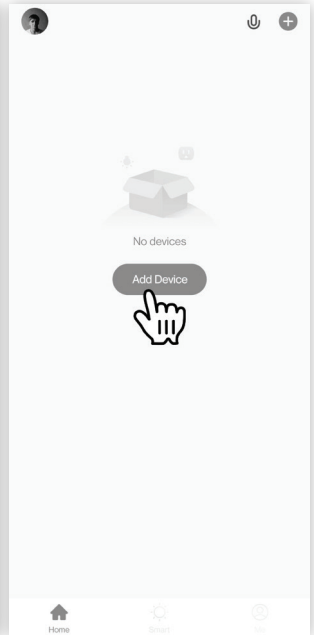

4

4. In the list on the left, select Small Home Appliances, and in the list on the right, select Air Purifier (Wi-Fi).

5. Give all the required permissions to the app.

6. In the next screen, select the Wi-Fi network you want to connect the purifier in and enter the password to this network. **Please note** that the purifier supports only 2.4GHz Wi-Fi networks, it will not connect to the app if 5Ghz network is used.

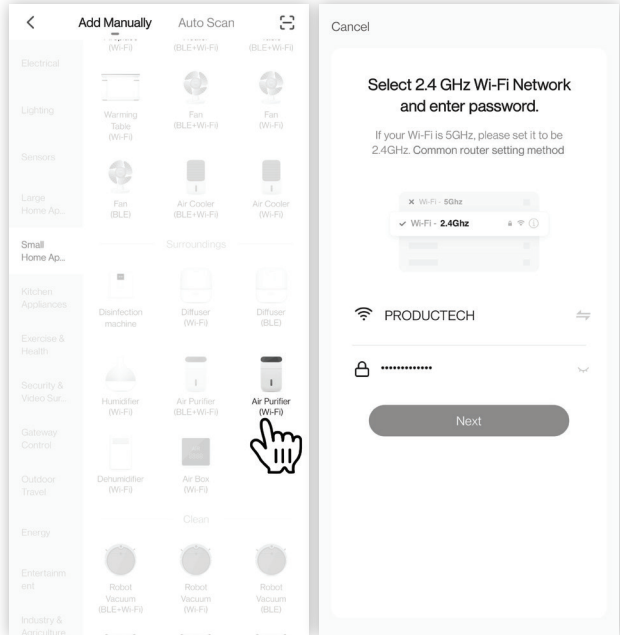

6

7. After that, from the **Standby state**, press and hold the **IONIZER** button on the purifier's control panel until you hear the sound prompt and the WiFi LED starts flashing.

8. In the app, confirm that you entered the Wi-Fi pairing mode on the purifier and tap on Next.

7



8

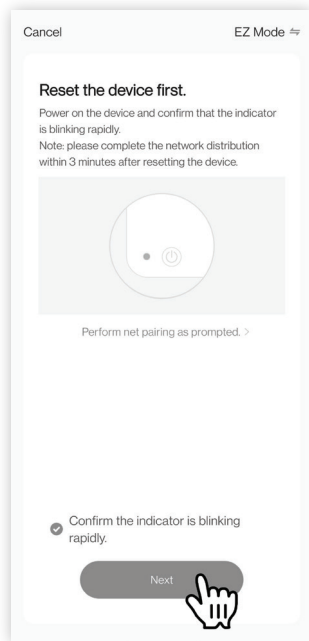

9. Wait until the app finds the **TURONIC PH950** purifier.

Note:

Once connected, you will be able to control the **PH950** purifier using not only Wi-Fi, but also 4G/5G networks.

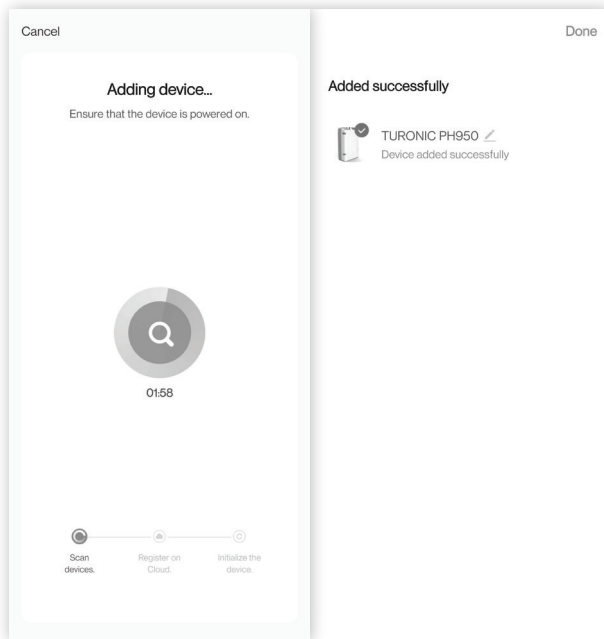

1**2**

APP FEATURES

In the app, you will be able to do the following:

1. Power on/off the device
2. Change the mode between Manual, Auto and Sleep modes.

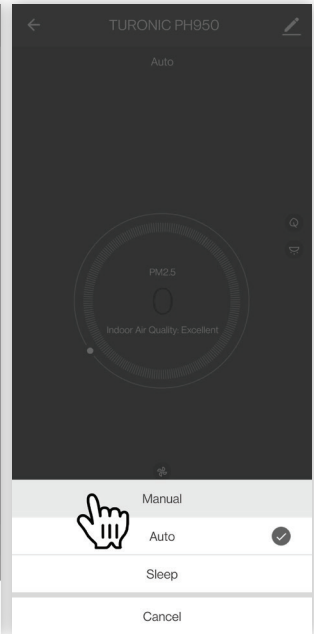
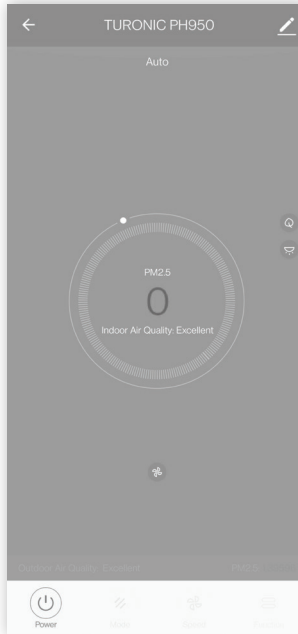

3

3. Control the fan speed.

4. Control UV/Ionization/Child Lock and Timer.

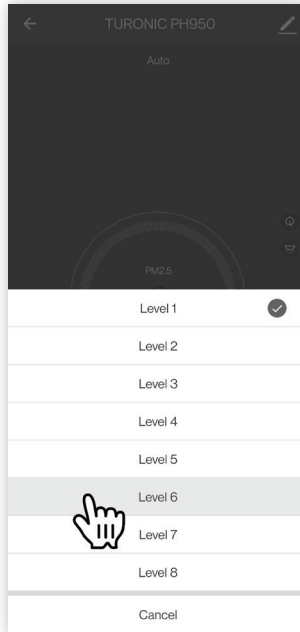

4

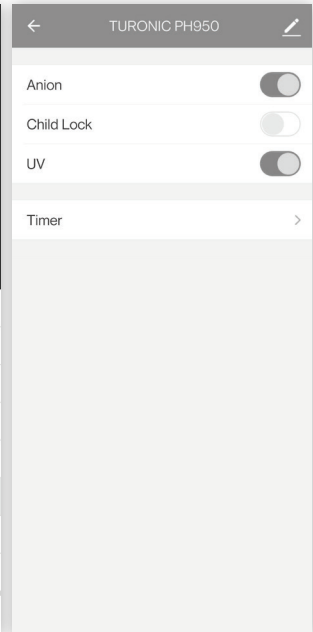

5. Rename the device, link it to the Smart Home Kits (Alexa, Google, etc.) and so on.

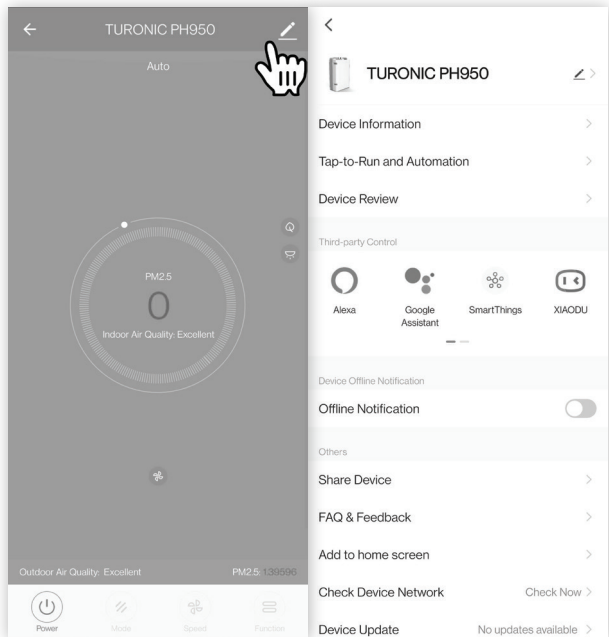

Note:

To connect the purifier to several devices you need to install the Smart Life application to the second device and log in into the same account.

If you want to use another Smart Life account on another device, do the following:

1. Install the Smart Life application to the second device.
2. Log in into the account but do not add a new device.
3. On the first device go to **TURONIC PH950**, press the **Edit** button in the upper right corner. 
4. Select **Share Device** option and then **Add Sharing**.
5. Send the invitation link via any suitable messenger.
6. Open the link on the second device using the Smart Life.
7. Accept the invitation on the second device.
8. The purifier will be added to the list.

HOW TO CLEAN

There are several things that should be regularly cleaned: air inlets/outlet grill, filters + pre-filter, water tank, anion generator and PM2.5 sensor.

To clean the inlets/outlet grill:

1. Shut down the unit and disconnect the power plug from a power source.
2. Wipe the inlets and outlet grill with a slightly damp cloth or vacuum them.

To clean the filters:

1. Shut down the unit and disconnect the power plug from a power source.
2. Open the filter cover and carefully remove the pre-filter #1 .
3. Clean the surface of the pre-filter with a vacuum cleaner or hand wash it with a soaped water. Let it dry well.
4. Take out the combination filter #2 (activated carbon + cold catalyst filter) and clean the front side (cold catalyst layer) using a vacuum cleaner.
5. Place the combination filter #2 in a well ventilated area. **DO NOT** wash the filter with water.
6. Take out the combination filter #3 (antibacterial cotton + HEPA filter) and place it in a well ventilated area. **DO NOT** wash the filter with water.
7. Install the combination filter #3 and the combination filter #2 back into the purifier.
8. Instal the dried pre-filter #1.

9. Close the filter cover and power on the purifier.

To clean the water tank:

1. Remove the water tank from the side of the purifier.
2. Remove the humidification filter and hand wash it with water.
3. Open the water tank by unclipping three clips on the sides.
4. Wash the water tank with water. **Make sure** that the anti-bacterial balls capsule and water level indicator are in their places.
5. Install the water tank lid back in its place.
6. Put the water tank into the purifier.

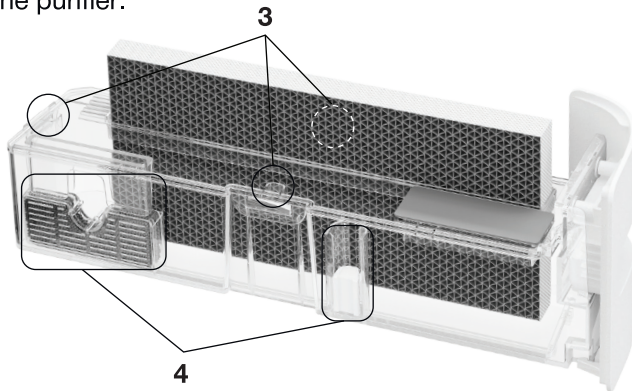

To clean the anion generator:

1. Shut down the unit and disconnect the power plug from a power source.
2. Using a #1 or #2 paint brush clean the anion emission head through the outlet grill.

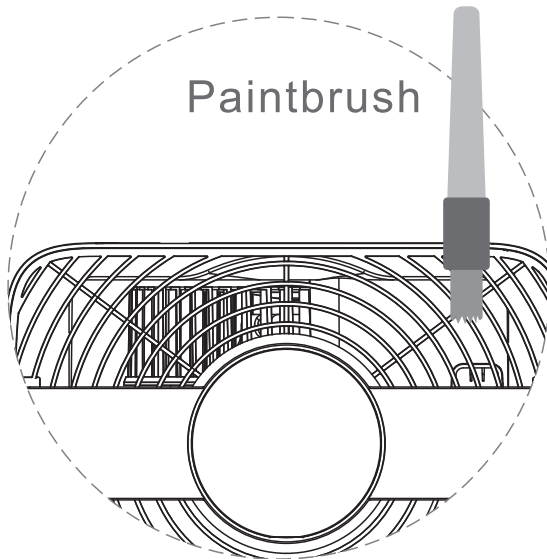

To clean the PM2.5 sensor:

1. Shut down the unit and disconnect the power plug from a power source.
2. Open carefully the sensor cover on the left side of the unit.
3. Wipe the lens of the sensor and its surface by using a dry cotton swab.
4. Close the sensor cover.

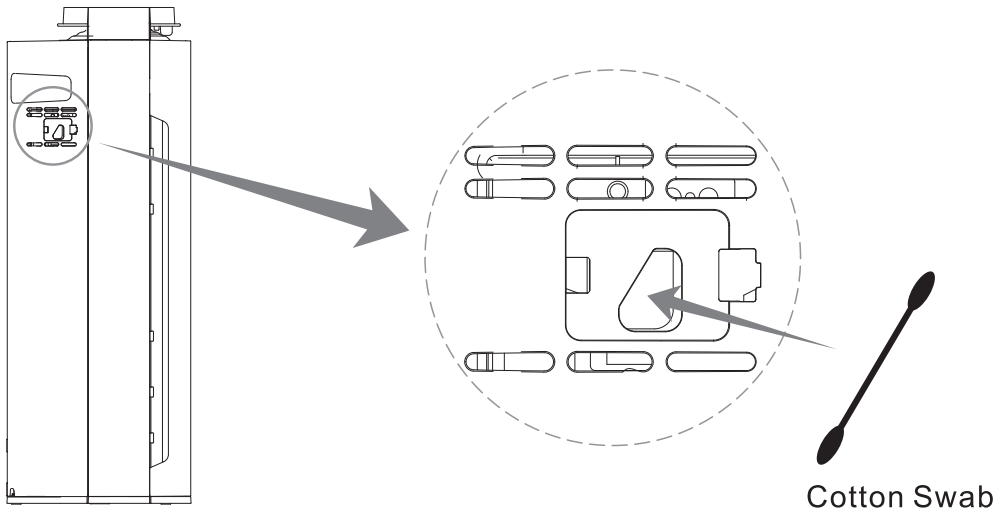

Cleaning intervals:

| | |
|------------------------------|----------------------------------|
| Pre-filter #1 | twice a month or every 320 hours |
| Combination filter #2 and #3 | once two month |
| Water tank | once a month |
| Anion generator | twice a month |
| PM2.5 sensor | twice a month |

FILTER REPLACEMENT

The **PH950** purifier has a regular reminder of filter replacement, which works every 320 hours and 1500 hours of operation.



After every 320 hours of operation, the **CHANGE FILTER** indicator light on the control panel will flash to remind you to clean the pre-filter #1. For this procedure, please check the **HOW TO CLEAN** section above. After cleaning the pre-filter, press the **RESET** button for 5 seconds, the light will stop flashing.

After every 1500 hours of operation, the **CHANGE FILTER** indicator light will go on steadily to inform you to renew the combination filters #2 and #3. When this happens:

1. Shut down the unit and unplug the power cord.
2. Open the filter cover.
3. Remove the pre-filter and put it aside.
4. Take out the used combination filters and pack them into a bag to avoid any second pollution. The combination filters that are out of service cannot be reused even if they are clean. Please consider them as non-burnable waste.
5. Remove the new combination filters from the polybags.
6. Install the first combination filter marked with digit 3 (antibacterial cotton + HEPA) into the purifier. Please note that the side with the pull tab should be directed outwards.
7. Install the first combination filter marked with digit 2 (cold catalyst + activated carbon) into the purifier. Please note that the side with the pull tab should be directed outwards.
8. Install the pre-filter back on its place.

9. Close firmly the filter cover.
10. Connect the power plug to a power source.
11. Press the **POWER** button to turn the purifier on. Press the **RESET** button for 5 seconds to reset the filter time.

To check the current purifier runtime (displayed in hours), shortly press the **RESET** button on the control panel or on the remote control. Since the display can only show three figures, the thousands digit will be displayed first, then hundreds, tens and single. Read them together.

Note:

It is also recommended to replace the humidification filter once a year.

TROUBLESHOOTING

If the air purifier does not run smoothly, please check out the following guidelines.

| Problem | Possible reasons | Solutions |
|--|--|--|
| Machine cannot start | <ol style="list-style-type: none">1. Unplugged power cable2. Machine filter cover is not in position | <ol style="list-style-type: none">1. Reconnect a power plug2. Place the filter cover in position |
| Odor in the outlet | <ol style="list-style-type: none">1. Too many indoor pollutants such as smoke2. Humidification filter is dirty3. Combination filters are polluted severely | <ol style="list-style-type: none">1. Air out the place2. Clean the humidification filter3. Replace the combination filters |
| No obvious dust removal effect, no air quality improvement | <ol style="list-style-type: none">1. Filters are not installed into the machine2. Filters have not been removed out of polybags3. Machine is placed in a narrow space or space | <ol style="list-style-type: none">1. Install the filters correctly2. Remove the filters out of the polybags3. Place the unit at least a foot away from obstacles |

| | | |
|-------------------------------------|---|--|
| | <p>with nearby obstacles that may sabotage the purification process</p> <p>4. Filters are too dirty</p> | <p>4. Replace with new combination filters</p> |
| <p>Machine runs with loud noise</p> | <p>1. Purifier is installed on uneven surface</p> <p>2. Other matters stored in the machine</p> | <p>1. Check the installation, contact the customer support service</p> <p>2. Clean from other matters</p> |
| <p>Main buttons do not work</p> | <p>Child Lock mode is turned on</p> | <p>Press and hold the CHILD LOCK button on the control panel for 5 seconds or press the UNLOCK button on the remote control to disable the Child Lock mode</p> |
| <p>Chirping sound while running</p> | <p>The anion generator is dirty</p> | <p>Clean the anion emission head</p> |

RECYCLING

Please do not discard this product together with other household garbage. Kindly check your local regulations of disposing electrical and electronic products or contact your local waste management company for more information on the purifier disposal.

Also, you may check the recycling services on the following websites:

In the **US**, there are a couple of options:

<https://search.earth911.com>

<https://recyclenation.com/find>

<https://www.cta.tech/Consumer-Resources/Greener-Gadgets>

In **Canada**, please visit the links below for help:

<https://thinkreuse.net>

In the **UK**, please visit the links below for help:

<https://www.recycle-more.co.uk/>

<https://www.recyclenow.com/local-recycling>

SAFETY RULES

Turonic PH950 is not a medical device. Not intended to diagnose, treat, cure, or prevent any disease or health condition.

- Do not use the device without a filter.
- Please use the device in a room with a temperature higher than 32°F / 0°C and lower than 104°F / 40°C.
- There should be a certain space around the air purifier to allow the wind and ions to flow naturally, thus, improving the purification effect.
- Do not put your fingers or objects into the air inlet/outlet.
- Do not place the device close to open fire or hot objects.
- To avoid surface cracking or sensor failure, do not put it in places where black smoke might occur (kitchen, etc.)
- Please unplug the power cable from the power socket immediately, if any malfunction happens, such as smoking, bad smell, etc.
- Don't disassemble or modify your purifier for any reason. Doing this may cause the purifier to malfunction or become combustible. The damage to your device can void the manufacturer's warranty.
- To avoid any damage or malfunction of the sensor, please clean the device only with a soft cloth.

- To avoid any damage, electric shock or fire disasters, please do not clean the device with ethyl alcohol or organic solvents.
- To avoid electric shock or fire, please power off and unplug the power cord before cleaning or while not using the device.
- Don't put the device's LED lights close to humans' or animals' eyes.
- Device is not intended for use by disabled people, people with mental illness, intellectual disabilities or children.

SPECIFICATIONS

| | |
|--------------------|--|
| Rated power: | 95W |
| Rated Voltage: | 110-120V, 60Hz |
| CADR (Particles)*: | 287.2 ft ³ /min (488 m ³ /h) |
| Speed modes: | 8 speeds |
| Noise level: | ≤ 61 dB |
| Dimensions: | 2.03 x 1.31 x 0.75 ft / 620 x 400 x 230 mm |
| Weight: | 23.8 lbs / 10.8 kg |

*** CADR stands for Clean Air Delivery Rate and is measured in CFM which stands for cubic feet per minute (m³/hour). In general, this value shows exactly how much of the specific particles are removed from the air. In simple words, the CADR rating indicates how fast the air purifier can clean the air within a particular size room.**

THANK YOU!

We truly appreciate that you chose **TURONIC** as your trusted brand of air purifier and sincerely hope you enjoy the great efficiency and seamless usability that the **TURONIC PH950** provides. We love making our customers happy by providing true value with our products. If for any reason you are not completely satisfied with your purchase or have any questions, please contact us via support@turonic.com. We care about our customers most of all and are always here to serve you.

1 YEAR WARRANTY

Parts and Labor Warranty.
Please visit www.turonic.com
to register your product.

Manufactured for Productech
EPA Est. No. 99346-CHN-1

AIR PURIFIER PH950



